



Chipsmall Limited consists of a professional team with an average of over 10 year of expertise in the distribution of electronic components. Based in Hongkong, we have already established firm and mutual-benefit business relationships with customers from,Europe,America and south Asia,supplying obsolete and hard-to-find components to meet their specific needs.

With the principle of “Quality Parts,Customers Priority,Honest Operation,and Considerate Service”,our business mainly focus on the distribution of electronic components. Line cards we deal with include Microchip,ALPS,ROHM,Xilinx,Pulse,ON,Everlight and Freescale. Main products comprise IC,Modules,Potentiometer,IC Socket,Relay,Connector.Our parts cover such applications as commercial,industrial, and automotives areas.

We are looking forward to setting up business relationship with you and hope to provide you with the best service and solution. Let us make a better world for our industry!



## Contact us

Tel: +86-755-8981 8866 Fax: +86-755-8427 6832

Email & Skype: info@chipsmall.com Web: www.chipsmall.com

Address: A1208, Overseas Decoration Building, #122 Zhenhua RD., Futian, Shenzhen, China





# Complete, Quad, 12-/14-/16-Bit, Serial Input, Unipolar/Bipolar Voltage Output DACs

Data Sheet

**AD5724R/AD5734R/AD5754R**

## FEATURES

Complete, quad, 12-/14-/16-bit DACs  
Operates from single/dual supplies  
Software programmable output range  
+5 V, +10 V, +10.8 V,  $\pm 5$  V,  $\pm 10$  V,  $\pm 10.8$  V  
INL error:  $\pm 16$  LSB maximum, DNL error:  $\pm 1$  LSB maximum  
Total unadjusted error (TUE): 0.1% FSR maximum  
Settling time: 10  $\mu$ s typical  
Integrated reference:  $\pm 5$  ppm/ $^{\circ}$ C maximum  
Integrated reference buffers  
Output control during power-up/brownout  
Simultaneous updating via  $\overline{\text{LDAC}}$   
Asynchronous  $\overline{\text{CLR}}$  to zero scale/midscale  
DSP/microcontroller-compatible serial interface  
24-lead TSSOP  
Operating temperature range:  $-40^{\circ}$ C to  $+85^{\circ}$ C  
iCMOS<sup>®</sup> process technology

## APPLICATIONS

Industrial automation  
Closed-loop servo control, process control  
Automotive test and measurement  
Programmable logic controllers

## GENERAL DESCRIPTION

The AD5724R/AD5734R/AD5754R are quad, 12-/14-/16-bit serial input, voltage output, digital-to-analog converters (DACs). They operate from single supply voltages of +4.5 V up to +16.5 V or dual supply voltages from  $\pm 4.5$  V up to  $\pm 16.5$  V. Nominal full-scale output range is software selectable from +5 V, +10 V, +10.8 V,  $\pm 5$  V,  $\pm 10$  V, or  $\pm 10.8$  V. Integrated output amplifiers, reference buffers, and proprietary power-up/power-down control circuitry are also provided.

The devices offer guaranteed monotonicity, integral nonlinearity (INL) of  $\pm 16$  LSB maximum, low noise, 10  $\mu$ s typical settling time, and an on-chip +2.5 V reference.

The AD5724R/AD5734R/AD5754R use a serial interface that operates at clock rates up to 30 MHz and are compatible with DSP and microcontroller interface standards. Double buffering allows the simultaneous updating of all DACs. The input coding is user-selectable twos complement or offset binary for a bipolar output (depending on the state of Pin BIN/2sCOMP) and straight binary for a unipolar output. The asynchronous clear function clears all DAC registers to a user-selectable zero-scale or mid-scale output. The devices are available in a 24-lead TSSOP and offer guaranteed specifications over the  $-40^{\circ}$ C to  $+85^{\circ}$ C industrial temperature range.

Table 1. Pin Compatible Devices

Device Number	Description
AD5724/AD5734/AD5754	AD5724R/AD5734R/AD5754R without internal reference.
AD5722/AD5732/AD5752	Complete, dual, 12-/14-/16-bit, serial input, unipolar/bipolar, voltage output DACs.
AD5722R/AD5732R/AD5752R	AD5722/AD5732/AD5752 with internal reference.

Rev. G

[Document Feedback](#)

Information furnished by Analog Devices is believed to be accurate and reliable. However, no responsibility is assumed by Analog Devices for its use, nor for any infringements of patents or other rights of third parties that may result from its use. Specifications subject to change without notice. No license is granted by implication or otherwise under any patent or patent rights of Analog Devices. Trademarks and registered trademarks are the property of their respective owners.

One Technology Way, P.O. Box 9106, Norwood, MA 02062-9106, U.S.A.  
Tel: 781.329.4700 ©2009–2017 Analog Devices, Inc. All rights reserved.  
Technical Support [www.analog.com](http://www.analog.com)

## TABLE OF CONTENTS

Features .....	1	Transfer Function .....	22
Applications .....	1	Input Register .....	26
General Description .....	1	DAC Register .....	27
Revision History .....	2	Output Range Select Register .....	27
Functional Block Diagram .....	3	Control Register .....	28
Specifications .....	4	Power Control Register .....	29
AC Performance Characteristics .....	6	Design Features .....	30
Timing Characteristics .....	6	Analog Output Control .....	30
Timing Diagrams .....	7	Power-Down Mode .....	30
Absolute Maximum Ratings .....	9	Overcurrent Protection .....	30
ESD Caution .....	9	Thermal Shutdown .....	30
Pin Configuration and Function Descriptions .....	10	Internal Reference .....	30
Typical Performance Characteristics .....	11	Applications Information .....	31
Terminology .....	18	+5 V/±5 V Operation .....	31
Theory of Operation .....	20	Alternative Power-Up Sequence Support .....	31
Architecture .....	20	Layout Guidelines .....	31
Power-Up Sequence .....	20	Galvanically Isolated Interface .....	32
Serial Interface .....	20	Microprocessor Interfacing .....	32
Load DAC ( $\overline{\text{LDAC}}$ ) .....	22	Outline Dimensions .....	33
Asynchronous Clear ( $\overline{\text{CLR}}$ ) .....	22	Ordering Guide .....	33
Configuring the AD5724R/AD5734R/AD5754R .....	22		

## REVISION HISTORY

### 2/2017—Rev. F to Rev. G

Added Power-Up Sequence Section .....	20
Changes to Table 8 and Table 9 .....	23
Changes to Table 11 and Table 12 .....	24
Changes to Table 14 and Table 15 .....	25
Changes to Analog Output Control Section .....	30
Added Alternative Power-Up Sequence Support Section, Figure 49, and Figure 50; Renumbered Sequentially .....	31

### 2/2016—Rev. E to Rev. F

Changes to Table 2 .....	4
--------------------------	---

### 7/2011—Rev. D to Rev. E

Changes to $t_7$ , $t_8$ , and $t_{10}$ Parameters, Table 4 .....	6
---	---

### 5/2011—Rev. C to Rev. D

Changes to Configuring the AD5724R/AD5734R/AD5754R Section .....	22
--	----

### 7/2010—Rev. B to Rev. C

Changes to Table 28 .....	29
---------------------------	----

### 5/2010—Rev. A to Rev. B

Changes to Table 5 .....	9
Changes to Table 6 .....	10

### 3/2009—Rev. 0 to Rev. A

Added AD5724R Model .....	Throughout
Added 12-Bit Resolution .....	Throughout
Changes to Resolution and Integral Nonlinearity (INL) Parameters (Table 2) .....	4
Changes to Endnote 2 (Table 2) .....	5
Added Endnote 4 (Table 4) .....	6
Added Figure 8 and Figure 11 .....	11
Added Figure 39 .....	16
Added Ideal Output Voltage to Input Code Relationship—AD5724R Section .....	25
Added Table 21 .....	27
Changes to Ordering Guide .....	32

### 1/2009—Revision 0: Initial Version

# FUNCTIONAL BLOCK DIAGRAM

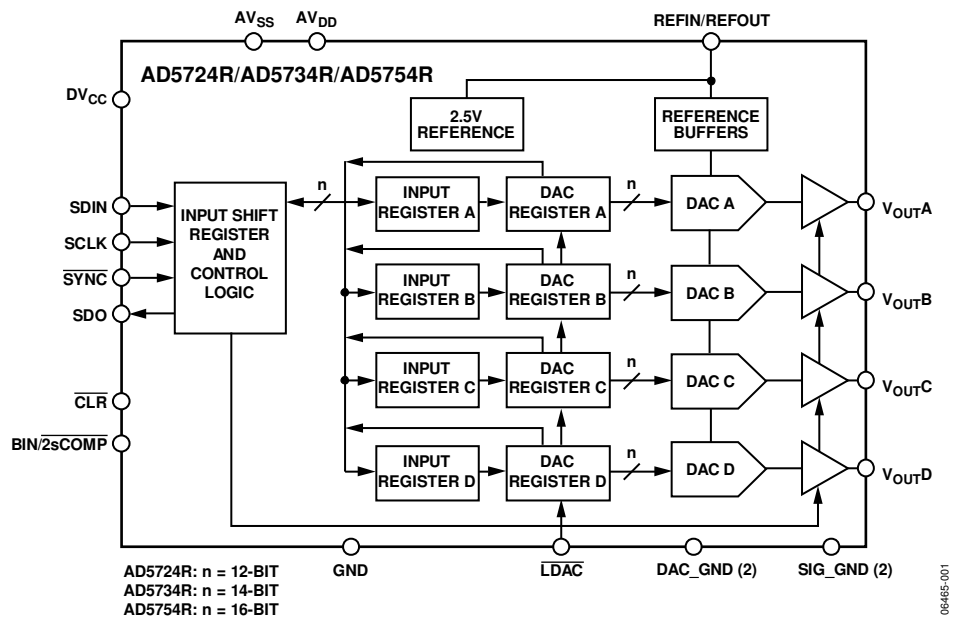

Figure 1.

## SPECIFICATIONS

$AV_{DD} = 4.5\text{ V}^1$  to  $16.5\text{ V}$ ,  $AV_{SS} = -4.5\text{ V}^1$  to  $-16.5\text{ V}$  or  $AV_{SS} = 0\text{ V}$ ,  $GND = 0\text{ V}$ ,  $REFIN = +2.5\text{ V}$  external,  $DV_{CC} = 2.7\text{ V}$  to  $5.5\text{ V}$ ,  $R_{LOAD} = 2\text{ k}\Omega$ ,  $C_{LOAD} = 200\text{ pF}$ , all specifications  $T_{MIN}$  to  $T_{MAX}$ , unless otherwise noted.

Table 2.

Parameter	Min	Typ	Max	Unit	Test Conditions/Comments
ACCURACY					Outputs unloaded
Resolution					
AD5754R	16			Bits	
AD5734R	14			Bits	
AD5724R	12			Bits	
Total Unadjusted Error (TUE)	-0.1		+0.1	% FSR	$\pm 10\text{ V}$ range
Integral Nonlinearity (INL) <sup>2</sup>					
AD5754R	-16		+16	LSB	
AD5734R	-4		+4	LSB	
AD5724R	-1		+1	LSB	
Differential Nonlinearity (DNL)	-1		+1	LSB	All models, guaranteed monotonic
Bipolar Zero Error	-6		+6	mV	$\pm 10\text{ V}$ range, $T_A = 25^\circ\text{C}$ , error at other temperatures obtained using bipolar zero TC
Bipolar Zero TC <sup>3</sup>		$\pm 4$		ppm FSR/ $^\circ\text{C}$	
Zero-Scale Error	-6		+6	mV	$\pm 10\text{ V}$ range, $T_A = 25^\circ\text{C}$ , error at other temperatures obtained using zero-scale TC
Zero-Scale TC <sup>3</sup>		$\pm 4$		ppm FSR/ $^\circ\text{C}$	
Offset Error	-6		+6	mV	$\pm 10\text{ V}$ range, $T_A = 25^\circ\text{C}$ , error at other temperatures obtained using offset error TC
Offset Error TC <sup>3</sup>		$\pm 4$		ppm FSR/ $^\circ\text{C}$	
Gain Error	-0.025		+0.025	% FSR	$\pm 10\text{ V}$ range, $T_A = 25^\circ\text{C}$ , error at other temperatures obtained using gain TC
Gain Error <sup>3</sup>	-0.065		0		+10 V and +5 V ranges, $T_A = 25^\circ\text{C}$ , error at other temperatures obtained using gain TC
Gain Error <sup>3</sup>	0		+0.08		$\pm 5\text{ V}$ range, $T_A = 25^\circ\text{C}$ , error at other temperatures obtained using gain TC
Gain TC <sup>3</sup>		$\pm 4$		ppm FSR/ $^\circ\text{C}$	
DC Crosstalk <sup>3</sup>			120	$\mu\text{V}$	
REFERENCE INPUT/OUTPUT					
Reference Input <sup>3</sup>					
Reference Input Voltage		2.5		V	$\pm 1\%$ for specified performance
DC Input Impedance	1	5		M $\Omega$	
Input Current	-2	$\pm 0.5$	+2	$\mu\text{A}$	
Reference Range	2		3	V	
Reference Output					
Output Voltage	2.497		2.501	V	$T_A = 25^\circ\text{C}$
Reference TC <sup>3,4</sup>		1.8	5	ppm/ $^\circ\text{C}$	$T_A = 0^\circ\text{C}$ to $85^\circ\text{C}$
		2.2	10	ppm/ $^\circ\text{C}$	$T_A = -40^\circ\text{C}$ to $+85^\circ\text{C}$
Output Noise (0.1 Hz to 10 Hz) <sup>3</sup>		5		$\mu\text{V}$ p-p	
Noise Spectral Density <sup>3</sup>		75		nV/ $\sqrt{\text{Hz}}$	At 10 kHz
OUTPUT CHARACTERISTICS <sup>3</sup>					
Output Voltage Range	-10.8		+10.8	V	$AV_{DD}/AV_{SS} = \pm 11.7\text{ V}$ min, $REFIN = +2.5\text{ V}$
	-12		+12	V	$AV_{DD}/AV_{SS} = \pm 12.9\text{ V}$ min, $REFIN = +3\text{ V}$
Headroom		0.5	0.9	V	
Output Voltage TC		$\pm 4$		ppm FSR/ $^\circ\text{C}$	
Output Voltage Drift vs. Time		$\pm 12$		ppm FSR/500 hr	
		$\pm 15$		ppm FSR/1000 hr	
Short-Circuit Current		20		mA	
Load	2			k $\Omega$	For specified performance
Capacitive Load Stability			4000	pF	
DC Output Impedance		0.5		$\Omega$	

Parameter	Min	Typ	Max	Unit	Test Conditions/Comments
<b>DIGITAL INPUTS<sup>3</sup></b>					$DV_{CC} = 2.7\text{ V to }5.5\text{ V}$ , JEDEC compliant
Input High Voltage, $V_{IH}$	2			V	
Input Low Voltage, $V_{IL}$			0.8	V	
Input Current			$\pm 1$	$\mu\text{A}$	Per pin
Pin Capacitance		5		pF	Per pin
<b>DIGITAL OUTPUTS (SDO)<sup>3</sup></b>					
Output Low Voltage, $V_{OL}$			0.4	V	$DV_{CC} = 5\text{ V} \pm 10\%$ , sinking 200 $\mu\text{A}$
Output High Voltage, $V_{OH}$	$DV_{CC} - 1$			V	$DV_{CC} = 5\text{ V} \pm 10\%$ , sourcing 200 $\mu\text{A}$
Output Low Voltage, $V_{OL}$			0.4	V	$DV_{CC} = 2.7\text{ V to }3.6\text{ V}$ , sinking 200 $\mu\text{A}$
Output High Voltage, $V_{OH}$	$DV_{CC} - 0.5$			V	$DV_{CC} = 2.7\text{ V to }3.6\text{ V}$ , sourcing 200 $\mu\text{A}$
High Impedance Leakage Current			$\pm 1$	$\mu\text{A}$	
High Impedance Output Capacitance		5		pF	
<b>POWER REQUIREMENTS</b>					
$AV_{DD}$	4.5		16.5	V	
$AV_{SS}$	-4.5		-16.5	V	
$DV_{CC}$	2.7		5.5	V	
Power Supply Sensitivity <sup>3</sup> $\Delta V_{OUT}/\Delta AV_{DD}$		-65		dB	200 mV sine wave superimposed on $AV_{SS}/AV_{DD}$ at 50 Hz/60 Hz
$AI_{DD}$			2.5	mA/channel	Outputs unloaded
			1.75	mA/channel	$AV_{SS} = 0\text{ V}$ , outputs unloaded
$AI_{SS}$			2.2	mA/channel	Outputs unloaded
$DI_{CC}$		0.5	3	$\mu\text{A}$	$V_{IH} = DV_{CC}$ , $V_{IL} = \text{GND}$ , 0.5 $\mu\text{A}$ typical
Power Dissipation			310	mW	$\pm 16.5\text{ V}$ operation, outputs unloaded
			115	mW	+16.5 V operation, outputs unloaded
Power-Down Currents					All DAC channels and internal reference powered-down
$AI_{DD}$		40		$\mu\text{A}$	
$AI_{SS}$		40		$\mu\text{A}$	
$DI_{CC}$		300		nA	

<sup>1</sup> For specified performance, headroom requirement is 0.9 V.

<sup>2</sup> INL is the relative accuracy. It is measured from Code 512, Code 128, and Code 32 for the AD5754R, AD5734R, and AD5724R respectively.

<sup>3</sup> Guaranteed by characterization; not production tested.

<sup>4</sup> The on-chip reference is production trimmed and tested at 25°C and 85°C. It is characterized from -40°C to +85°C.

**AC PERFORMANCE CHARACTERISTICS**

$AV_{DD} = 4.5\text{ V}^1$  to  $16.5\text{ V}$ ,  $AV_{SS} = -4.5\text{ V}^1$  to  $-16.5\text{ V}$  or  $0\text{ V}$ ,  $GND = 0\text{ V}$ ,  $REFIN = 2.5\text{ V}$  external,  $DV_{CC} = 2.7\text{ V}$  to  $5.5\text{ V}$ ,  $R_{LOAD} = 2\text{ k}\Omega$ ,  $C_{LOAD} = 200\text{ pF}$ , all specifications  $T_{MIN}$  to  $T_{MAX}$ , unless otherwise noted.

**Table 3.**

Parameter <sup>2</sup>	Min	Typ	Max	Unit	Test Conditions/Comments
<b>DYNAMIC PERFORMANCE</b>					
Output Voltage Settling Time		10	12	$\mu\text{s}$	20 V step to $\pm 0.03\%$ FSR
		7.5	8.5	$\mu\text{s}$	10 V step to $\pm 0.03\%$ FSR
			5	$\mu\text{s}$	512 LSB step settling (16-bit resolution)
Slew Rate		3.5		V/ $\mu\text{s}$	
Digital-to-Analog Glitch Energy		13		nV-sec	
Glitch Impulse Peak Amplitude		35		mV	
Digital Crosstalk		10		nV-sec	
DAC-to-DAC Crosstalk		10		nV-sec	
Digital Feedthrough		0.6		nV-sec	
Output Noise					
0.1 Hz to 10 Hz Bandwidth		15		$\mu\text{V}$ p-p	0x8000 DAC code
100 kHz Bandwidth		80		$\mu\text{V}$ rms	
Output Noise Spectral Density		320		nV/ $\sqrt{\text{Hz}}$	Measured at 10 kHz, 0x8000 DAC code

<sup>1</sup> For specified performance, headroom requirement is 0.9 V.

<sup>2</sup> Guaranteed by design and characterization; not production tested.

**TIMING CHARACTERISTICS**

$AV_{DD} = 4.5\text{ V}$  to  $16.5\text{ V}$ ,  $AV_{SS} = -4.5\text{ V}$  to  $-16.5\text{ V}$  or  $0\text{ V}$ ,  $GND = 0\text{ V}$ ,  $REFIN = 2.5\text{ V}$  external,  $DV_{CC} = 2.7\text{ V}$  to  $5.5\text{ V}$ ,  $R_{LOAD} = 2\text{ k}\Omega$ ,  $C_{LOAD} = 200\text{ pF}$ , all specifications are  $T_{MIN}$  to  $T_{MAX}$ , unless otherwise noted.

**Table 4.**

Parameter <sup>1, 2, 3</sup>	Limit at $T_{MIN}$ , $T_{MAX}$	Unit	Description
$t_1^4$	33	ns min	SCLK cycle time
$t_2$	13	ns min	SCLK high time
$t_3$	13	ns min	SCLK low time
$t_4$	13	ns min	$\overline{\text{SYNC}}$ falling edge to SCLK falling edge setup time
$t_5$	13	ns min	SCLK falling edge to $\overline{\text{SYNC}}$ rising edge
$t_6$	100	ns min	Minimum $\overline{\text{SYNC}}$ high time (write mode)
$t_7$	7	ns min	Data setup time
$t_8$	2	ns min	Data hold time
$t_9$	20	ns min	$\overline{\text{LDAC}}$ falling edge to $\overline{\text{SYNC}}$ falling edge
$t_{10}$	130	ns min	$\overline{\text{SYNC}}$ rising edge to $\overline{\text{LDAC}}$ falling edge
$t_{11}$	20	ns min	$\overline{\text{LDAC}}$ pulse width low
$t_{12}$	10	$\mu\text{s}$ typ	DAC output settling time
$t_{13}$	20	ns min	$\overline{\text{CLR}}$ pulse width low
$t_{14}$	2.5	$\mu\text{s}$ max	$\overline{\text{CLR}}$ pulse activation time
$t_{15}^5$	13	ns min	$\overline{\text{SYNC}}$ rising edge to SCLK falling edge
$t_{16}^5$	40	ns max	SCLK rising edge to SDO valid ( $C_{LSDO}^6 = 15\text{ pF}$ )
$t_{17}$	200	ns min	Minimum $\overline{\text{SYNC}}$ high time (readback/daisy-chain mode)

<sup>1</sup> Guaranteed by characterization; not production tested.

<sup>2</sup> All input signals are specified with  $t_r = t_f = 5\text{ ns}$  (10% to 90% of  $DV_{CC}$ ) and timed from a voltage level of 1.2 V.

<sup>3</sup> See Figure 2, Figure 3, and Figure 4.

<sup>4</sup> To accommodate  $t_{16}$ , in readback and daisy-chain modes the SCLK cycle time must be increased to 90 ns.

<sup>5</sup> Daisy-chain and readback mode.

<sup>6</sup>  $C_{LSDO}$  = capacitive load on SDO output.

TIMING DIAGRAMS

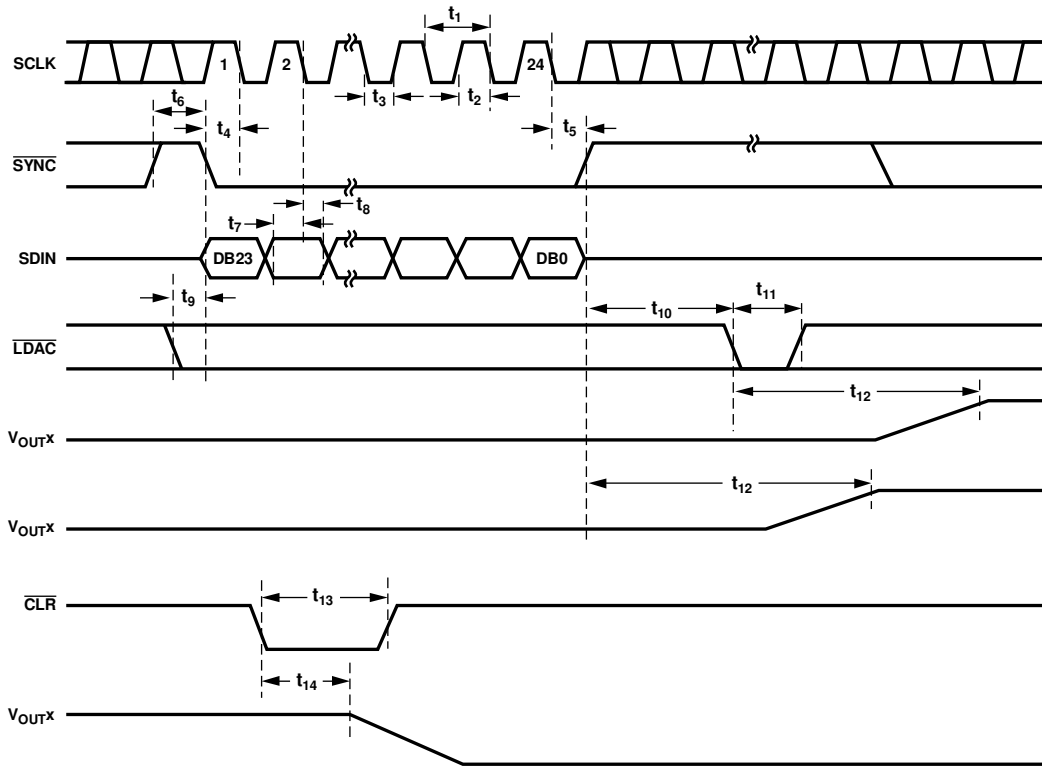

Figure 2. Serial Interface Timing Diagram

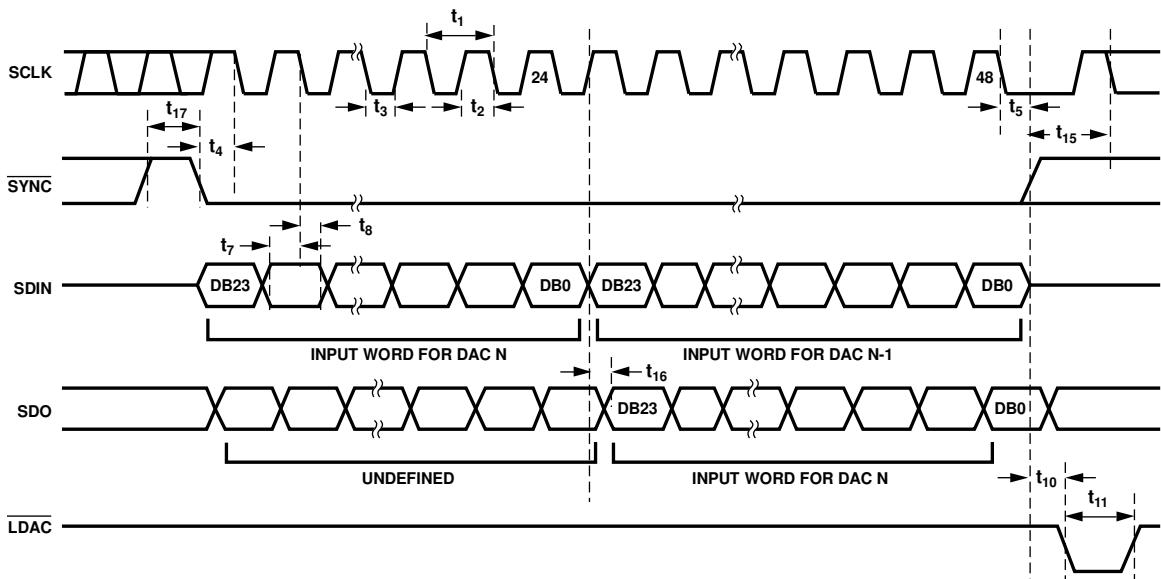
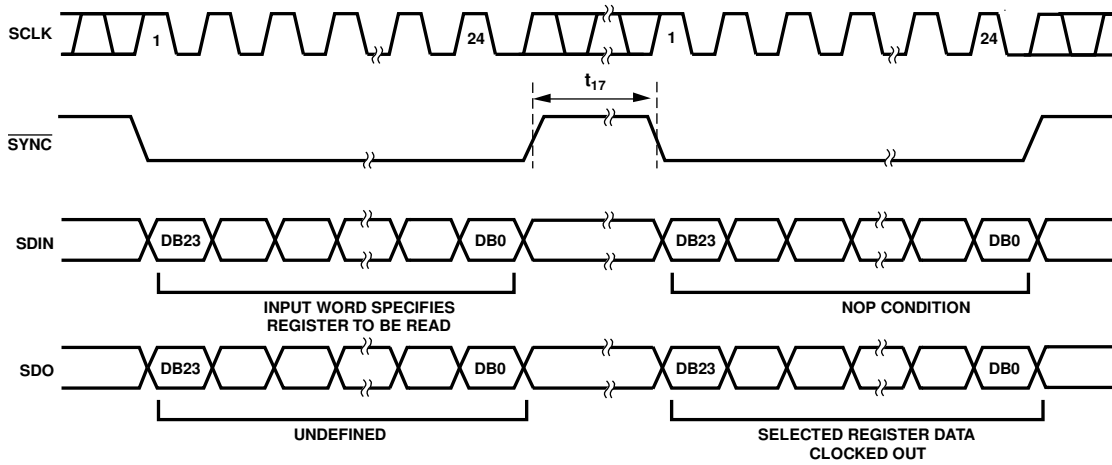

Figure 3. Daisy-Chain Timing Diagram





06465-004

Figure 4. Readback Timing Diagram

## ABSOLUTE MAXIMUM RATINGS

$T_A = 25^\circ\text{C}$ , unless otherwise noted. Transient currents of up to 100 mA do not cause SCR latch-up.

Table 5.

Parameter	Rating
$AV_{DD}$ to GND	-0.3 V to +17 V
$AV_{SS}$ to GND	+0.3 V to -17 V
$DV_{CC}$ to GND	-0.3 V to +7 V
Digital Inputs to GND	-0.3 V to $DV_{CC} + 0.3$ V or 7 V (whichever is less)
Digital Outputs to GND	-0.3 V to $DV_{CC} + 0.3$ V or 7 V (whichever is less)
REFIN/REFOUT to GND	-0.3 V to +5 V
$V_{OUTX}$ to GND	$AV_{SS}$ to $AV_{DD}$
DAC_GND to GND	-0.3 V to +0.3 V
SIG_GND to GND	-0.3 V to +0.3 V
Operating Temperature Range, $T_A$ Industrial	-40°C to +85°C
Storage Temperature Range	-65°C to +150°C
Junction Temperature, $T_J$ max	150°C
24-Lead TSSOP	
$\theta_{JA}$ Thermal Impedance	42°C/W
$\theta_{JC}$ Thermal Impedance	9°C/W
Power Dissipation	$(T_J \text{ max} - T_A)/\theta_{JA}$
Lead Temperature	JEDEC industry standard
Soldering	J-STD-020
ESD (Human Body Model)	3.5 kV

Stresses at or above those listed under Absolute Maximum Ratings may cause permanent damage to the product. This is a stress rating only; functional operation of the product at these or any other conditions above those indicated in the operational section of this specification is not implied. Operation beyond the maximum operating conditions for extended periods may affect product reliability.

### ESD CAUTION



**ESD (electrostatic discharge) sensitive device.** Charged devices and circuit boards can discharge without detection. Although this product features patented or proprietary protection circuitry, damage may occur on devices subjected to high energy ESD. Therefore, proper ESD precautions should be taken to avoid performance degradation or loss of functionality.

## PIN CONFIGURATION AND FUNCTION DESCRIPTIONS

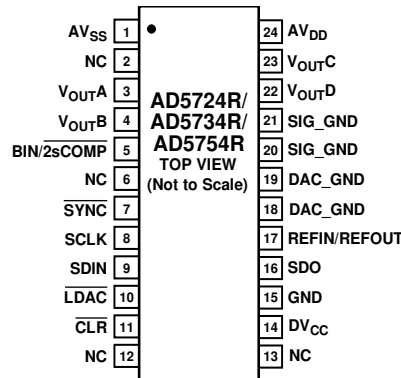

- NOTES
1. NC = NO CONNECT. DO NOT CONNECT TO THIS PIN.
  2. IT IS RECOMMENDED THAT THE EXPOSED PAD BE THERMALLY CONNECTED TO A COPPER PLANE FOR ENHANCED THERMAL PERFORMANCE.

06-465-005

Figure 5. Pin Configuration

Table 6. Pin Function Descriptions

Pin No.	Mnemonic	Description
1	AV <sub>SS</sub>	Negative Analog Supply Pin. Voltage range is from $-4.5\text{ V}$ to $-16.5\text{ V}$ . This pin can be connected to $0\text{ V}$ if output ranges are unipolar.
2, 6, 12, 13	NC	No Connect. Do not connect to these pins.
3	V <sub>OUTA</sub>	Analog Output Voltage of DAC A. The output amplifier is capable of directly driving a $2\text{ k}\Omega$ , $4000\text{ pF}$ load.
4	V <sub>OUTB</sub>	Analog Output Voltage of DAC B. The output amplifier is capable of directly driving a $2\text{ k}\Omega$ , $4000\text{ pF}$ load.
5	BIN/ $2s$ COMP	This pin determines the DAC coding for a bipolar output range. This pin should be hardwired to either DV <sub>CC</sub> or GND. When hardwired to DV <sub>CC</sub> , input coding is offset binary. When hardwired to GND, input coding is twos complement. (For unipolar output ranges, coding is always straight binary.)
7	$\overline{\text{SYNC}}$	Active Low Input. This is the frame synchronization signal for the serial interface. While $\overline{\text{SYNC}}$ is low, data is transferred on the falling edge of SCLK. Data is latched on the rising edge of $\overline{\text{SYNC}}$ .
8	SCLK	Serial Clock Input. Data is clocked into the shift register on the falling edge of SCLK. This operates at clock speeds up to $30\text{ MHz}$ .
9	SDIN	Serial Data Input. Data must be valid on the falling edge of SCLK.
10	$\overline{\text{LDAC}}$	Load DAC, Logic Input. This is used to update the DAC registers and, consequently, the analog output. When tied permanently low, the addressed DAC register is updated on the rising edge of $\overline{\text{SYNC}}$ . If $\overline{\text{LDAC}}$ is held high during the write cycle, the DAC input register is updated, but the output update is held off until the falling edge of $\overline{\text{LDAC}}$ . In this mode, all analog outputs can be updated simultaneously on the falling edge of $\overline{\text{LDAC}}$ . The $\overline{\text{LDAC}}$ pin should not be left unconnected.
11	$\overline{\text{CLR}}$	Active Low Input. Asserting this pin sets the DAC registers to zero-scale code or midscale code (user selectable).
14	DV <sub>CC</sub>	Digital Supply Pin. Voltage range is from $2.7\text{ V}$ to $5.5\text{ V}$ .
15	GND	Ground Reference Pin.
16	SDO	Serial Data Output. Used to clock data from the serial register in daisy-chain or readback mode. Data is clocked out on the rising edge of SCLK and is valid on the falling edge of SCLK.
17	REFIN/REFOUT	External Reference Voltage Input and Internal Reference Voltage Output. Reference input range is $2\text{ V}$ to $3\text{ V}$ . REFIN = $2.5\text{ V}$ for specified performance. REFOUT = $2.5\text{ V} \pm 2\text{ mV}$ at $25^\circ\text{C}$ .
18, 19	DAC_GND	Ground reference pins for the four digital-to-analog converters.
20, 21	SIG_GND	Ground reference pins for the four output amplifiers.
22	V <sub>OUTD</sub>	Analog Output Voltage of DAC D. The output amplifier is capable of directly driving a $2\text{ k}\Omega$ , $4000\text{ pF}$ load.
23	V <sub>OUTC</sub>	Analog Output Voltage of DAC C. The output amplifier is capable of directly driving a $2\text{ k}\Omega$ , $4000\text{ pF}$ load.
24	AV <sub>DD</sub>	Positive Analog Supply Pin. Voltage range is from $4.5\text{ V}$ to $16.5\text{ V}$ .
	EPAD	Exposed Paddle. The exposed paddle should be connected to the potential of the AV <sub>SS</sub> pin or, alternatively, it can be left electrically unconnected. It is recommended that the paddle be thermally connected to a copper plane for enhanced thermal performance.

TYPICAL PERFORMANCE CHARACTERISTICS

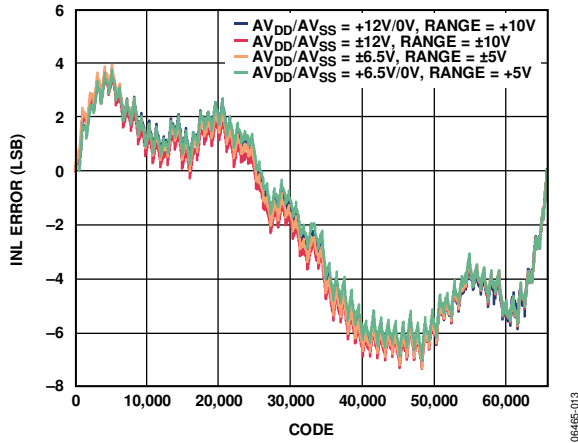

Figure 6. AD5754R Integral Nonlinearity Error vs. Code

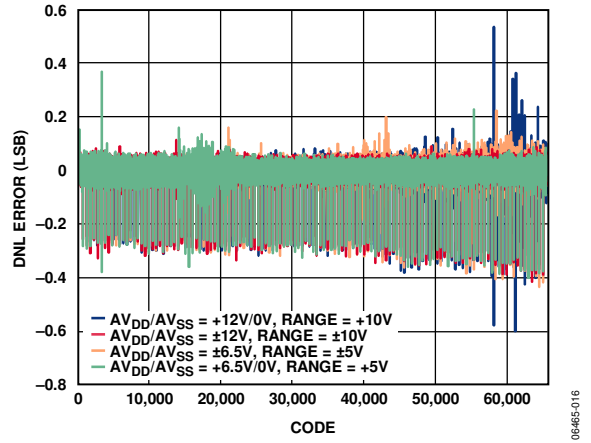

Figure 9. AD5754R Differential Nonlinearity Error vs. Code

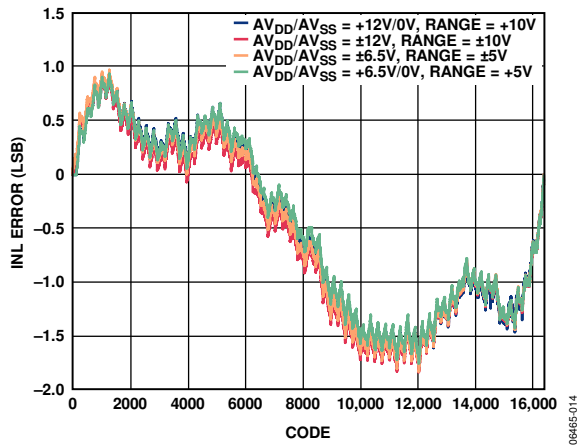

Figure 7. AD5734R Integral Nonlinearity Error vs. Code

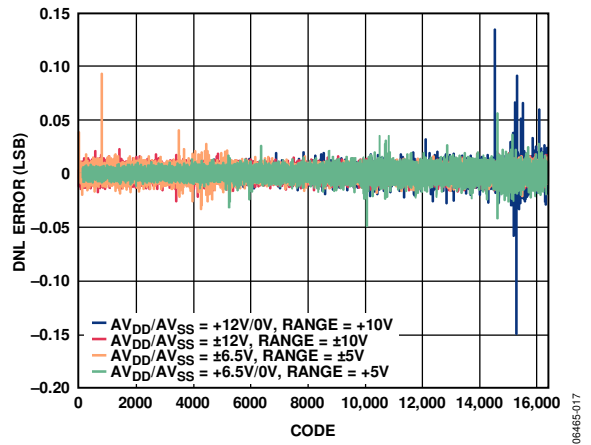

Figure 10. AD5734R Differential Nonlinearity Error vs. Code

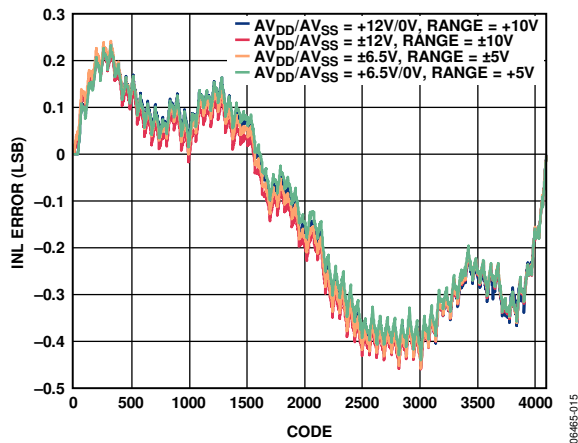

Figure 8. AD5724R Integral Nonlinearity Error vs. Code

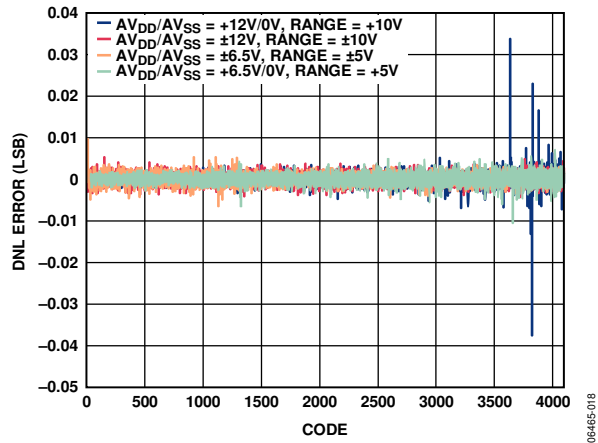

Figure 11. AD5724R Differential Nonlinearity Error vs. Code

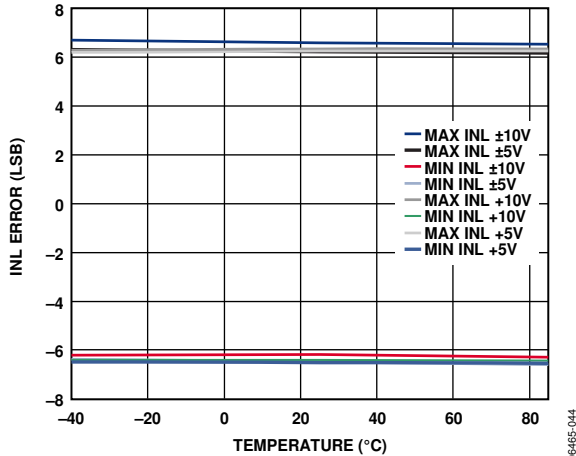

Figure 12. AD5754R Integral Nonlinearity Error vs. Temperature

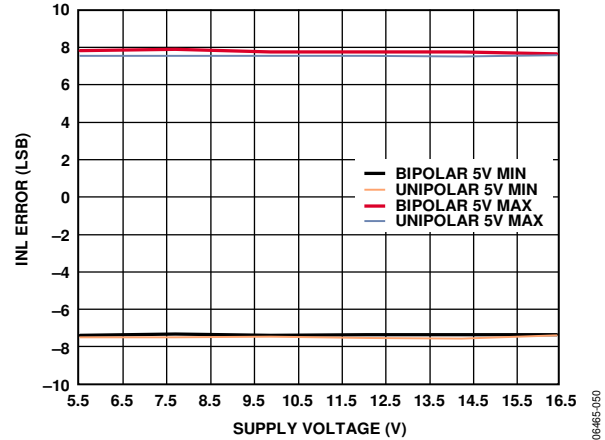

Figure 15. AD5754R Integral Nonlinearity Error vs. Supply Voltage

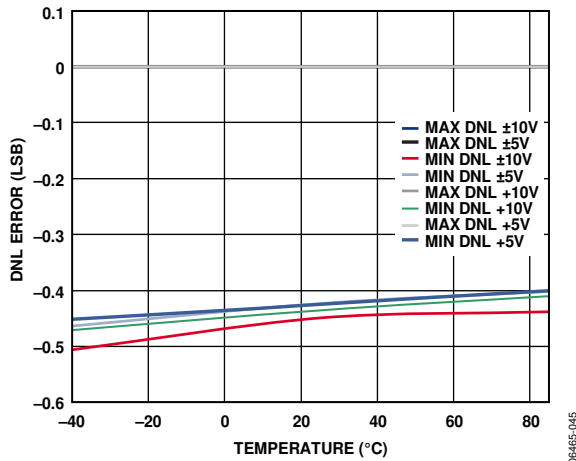

Figure 13. AD5754R Differential Nonlinearity Error vs. Temperature

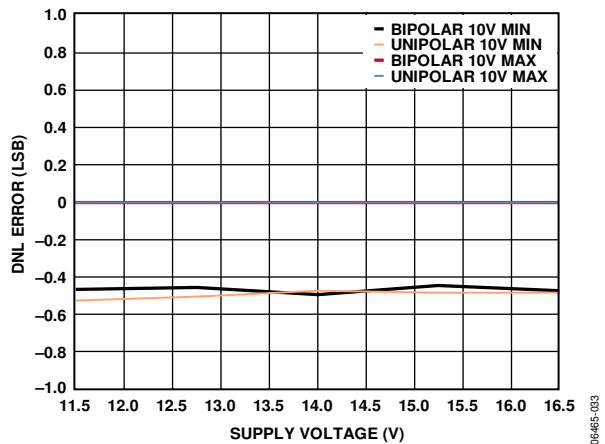

Figure 16. AD5754R Differential Nonlinearity Error vs. Supply Voltage

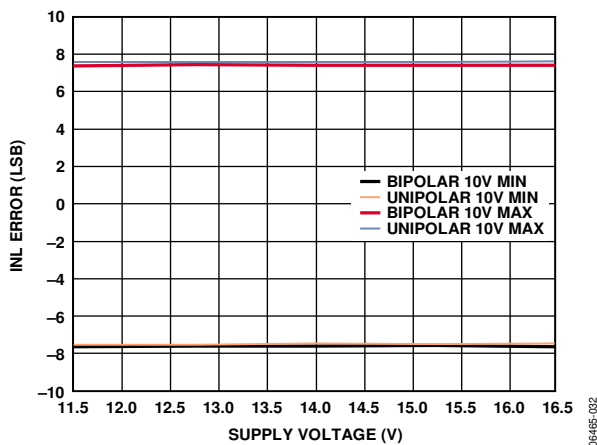

Figure 14. AD5754R Integral Nonlinearity Error vs. Supply Voltage

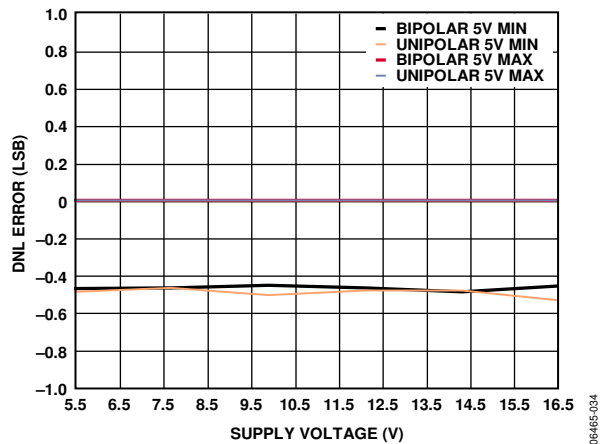

Figure 17. AD5754R Differential Nonlinearity Error vs. Supply Voltage

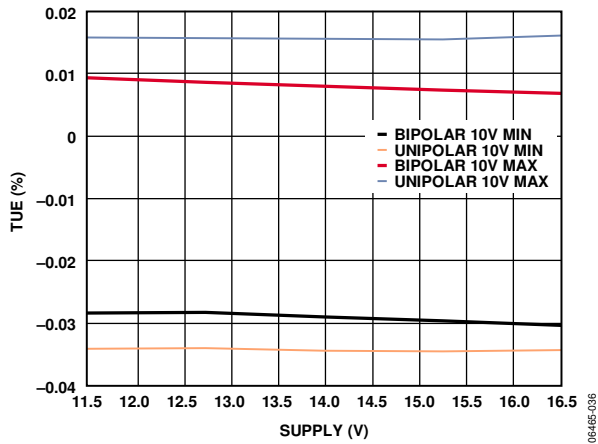

Figure 18. AD5754R Total Unadjusted Error vs. Supply Voltage

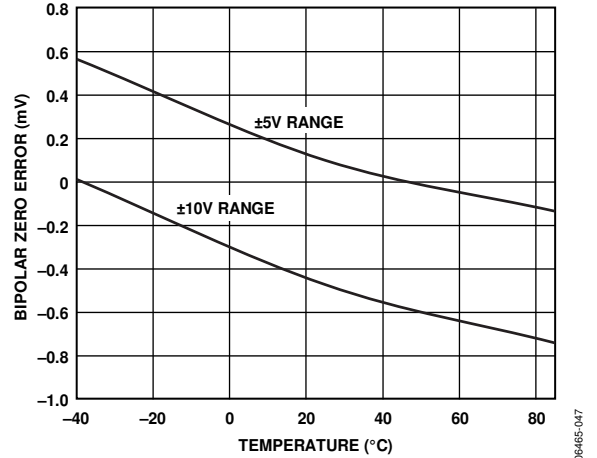

Figure 21. Bipolar Zero Error vs. Temperature

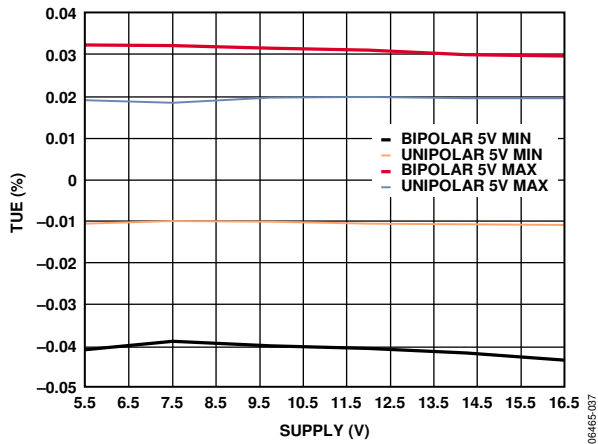

Figure 19. AD5754R Total Unadjusted Error vs. Supply Voltage

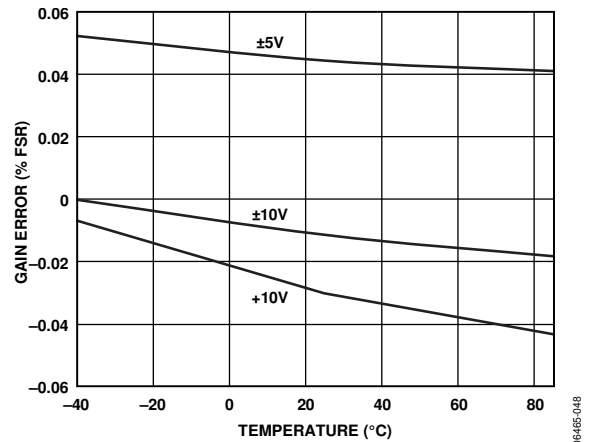

Figure 22. Gain Error vs. Temperature

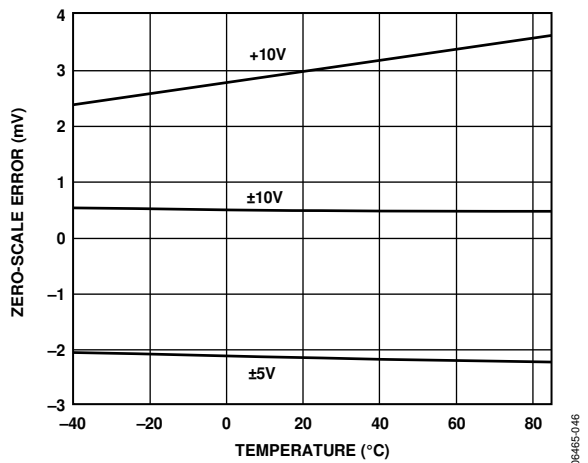

Figure 20. Zero-Scale Error vs. Temperature

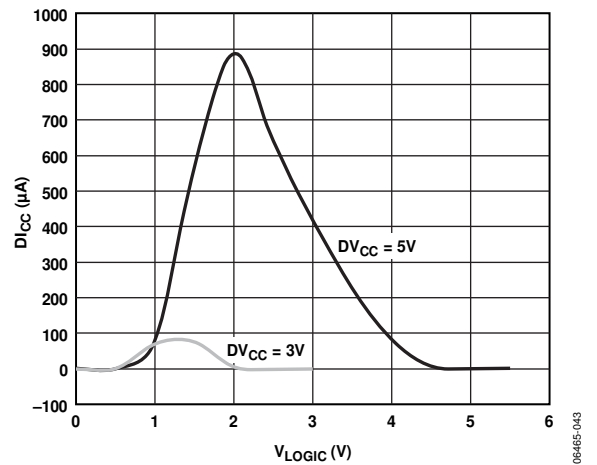

Figure 23. Digital Current vs. Logic Input Voltage

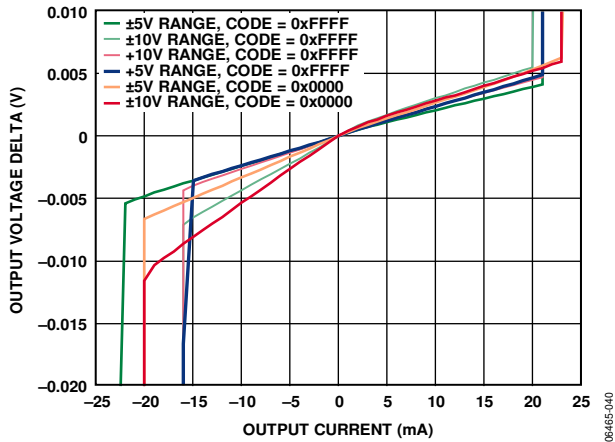

Figure 24. Output Source and Sink Capability

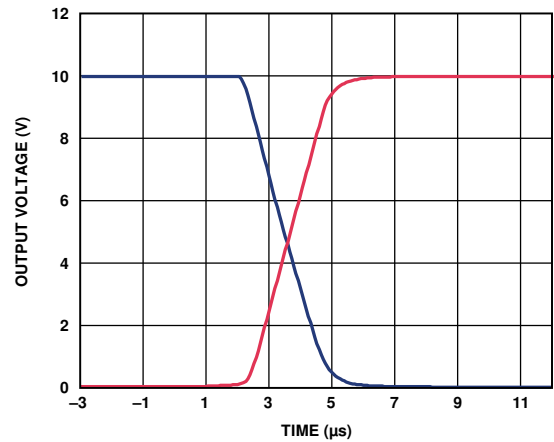

Figure 27. Full-Scale Settling, +10 V Range

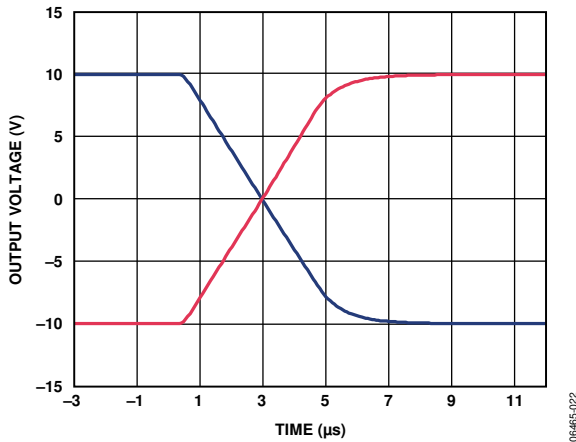

Figure 25. Full-Scale Settling Time, ±10 V Range

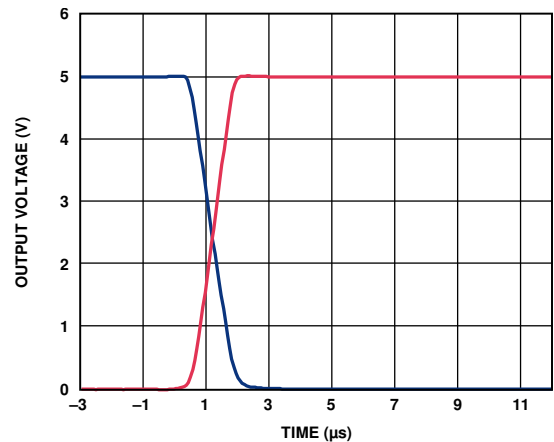

Figure 28. Full-Scale Settling, +5 V Range

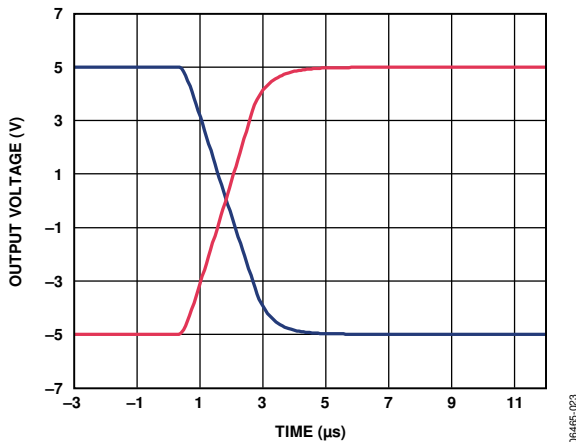

Figure 26. Full-Scale Settling, ±5 V Range

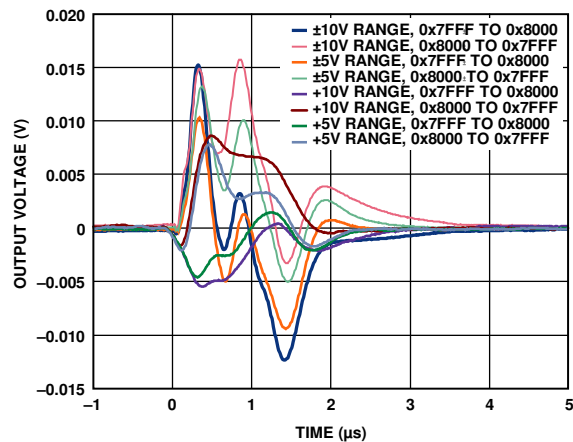

Figure 29. Digital-to-Analog Glitch Energy

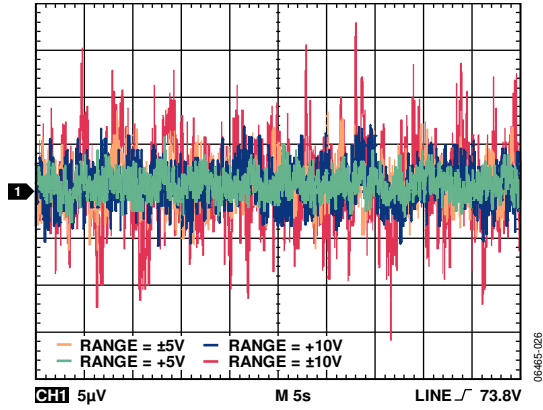

Figure 30. Peak-to-Peak Noise, 0.1 Hz to 10 Hz Bandwidth

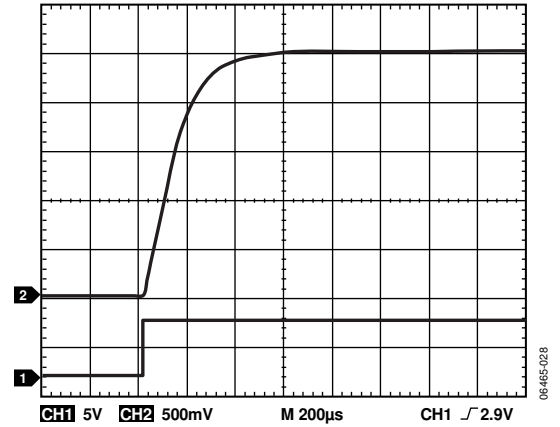

Figure 33. REFOUT Turn-On Transient

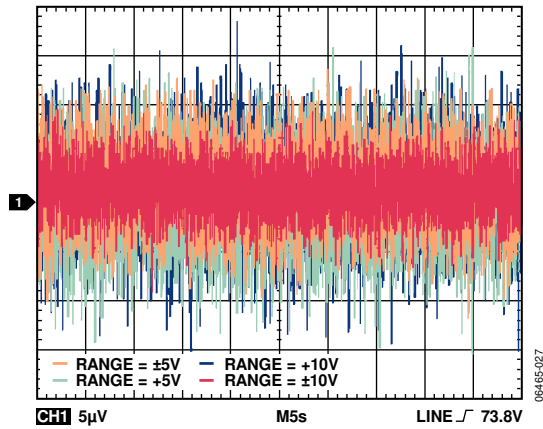

Figure 31. Peak-to-Peak Noise, 100 kHz Bandwidth

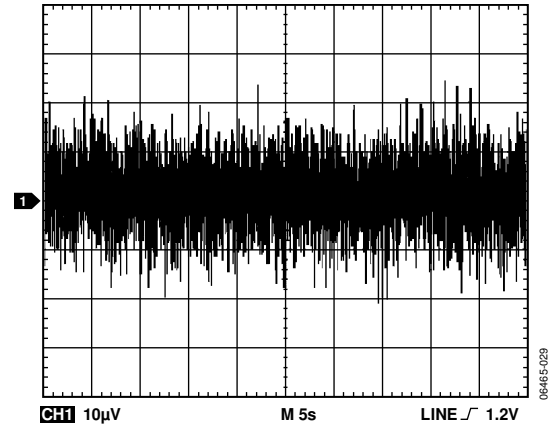

Figure 34. REFOUT Output Noise (100 kHz Bandwidth)

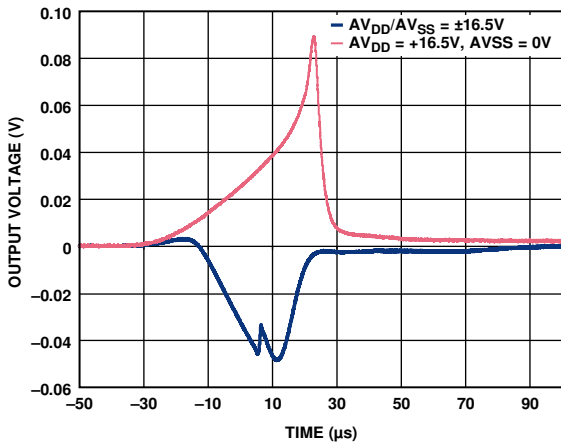

Figure 32. Output Glitch on Power-Up

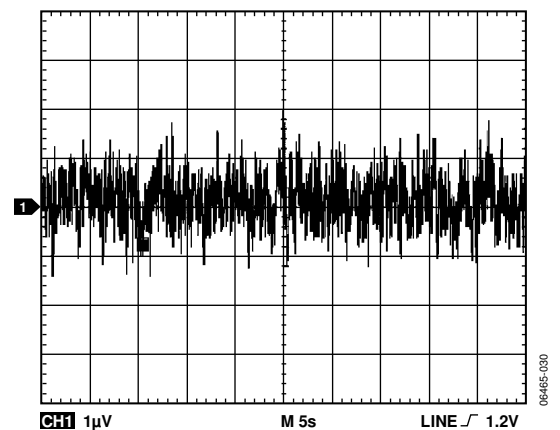

Figure 35. REFOUT Output Noise (0.1 Hz to 10 Hz Bandwidth)



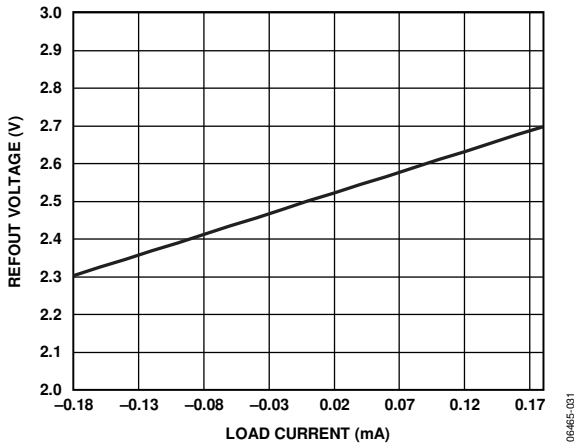

Figure 36. REFOUT Voltage vs. Load Current

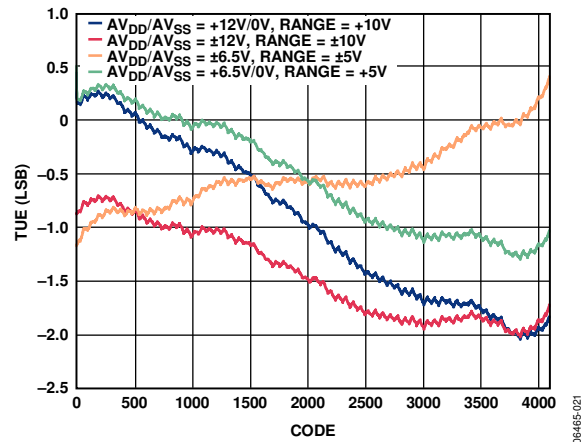

Figure 39. AD5724R Total Unadjusted Error vs. Code

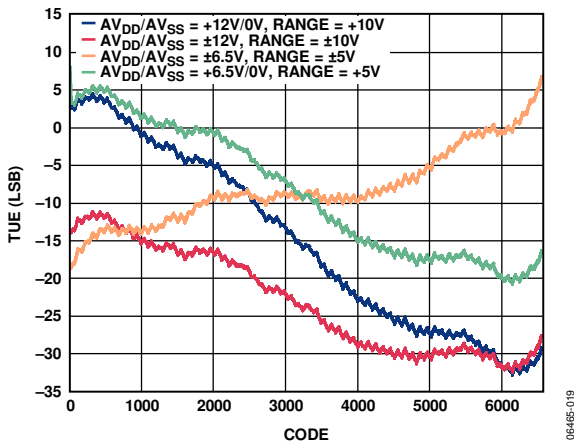

Figure 37. AD5754R Total Unadjusted Error vs. Code

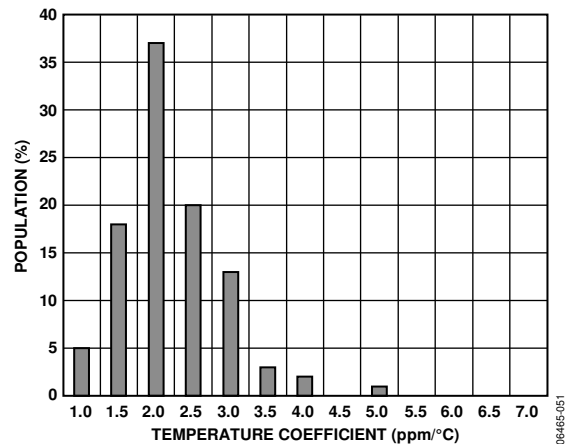

Figure 40. Reference Output TC (-40°C to +85°C)

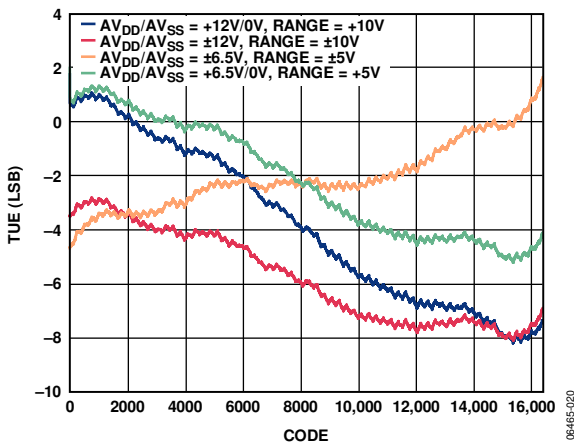

Figure 38. AD5734R Total Unadjusted Error vs. Code

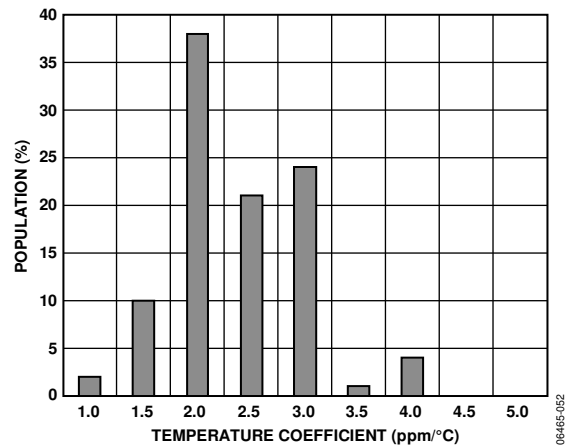

Figure 41. Reference Output TC (0°C to 85°C)

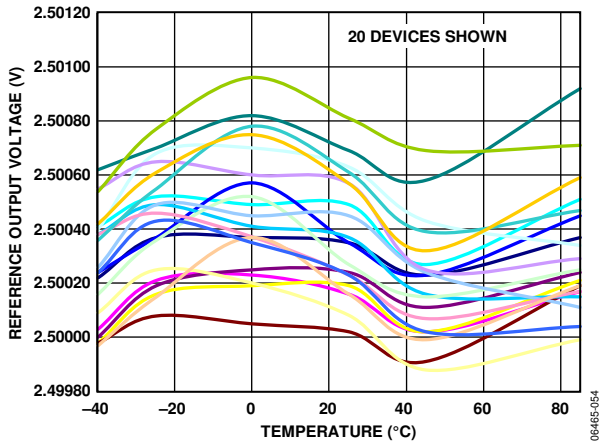

Figure 42. Reference Output Voltage vs. Temperature (-40°C to +85°C)

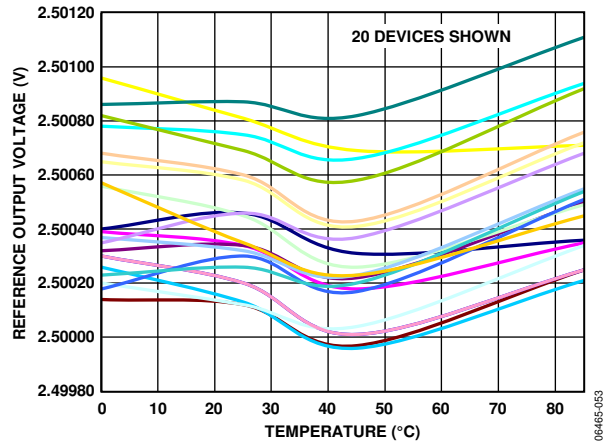

Figure 43. Reference Output Voltage vs. Temperature (0°C to +85°C)

## TERMINOLOGY

### Relative Accuracy or Integral Nonlinearity (INL)

For the DAC, relative accuracy, or integral nonlinearity, is a measure of the maximum deviation in LSBs from a straight line passing through the endpoints of the DAC transfer function. A typical INL vs. code plot can be seen in Figure 6.

### Differential Nonlinearity (DNL)

Differential nonlinearity is the difference between the measured change and the ideal 1 LSB change between any two adjacent codes. A specified differential nonlinearity of  $\pm 1$  LSB maximum ensures monotonicity. This DAC is guaranteed monotonic by design. A typical DNL vs. code plot can be seen in Figure 9.

### Monotonicity

A DAC is monotonic if the output either increases or remains constant for increasing digital input code. The [AD5724R/AD5734R/AD5754R](#) are monotonic over their full operating temperature range.

### Bipolar Zero Error

Bipolar zero error is the deviation of the analog output from the ideal half-scale output of 0 V when the DAC register is loaded with 0x8000 (straight binary coding) or 0x0000 (twos complement coding). A plot of bipolar zero error vs. temperature can be seen in Figure 21.

### Bipolar Zero TC

Bipolar zero TC is a measure of the change in the bipolar zero error with a change in temperature. It is expressed in ppm FSR/°C.

### Zero-Scale Error/Negative Full-Scale Error

Zero-scale error is the error in the DAC output voltage when 0x0000 (straight binary coding) or 0x8000 (twos complement coding) is loaded to the DAC register. Ideally, the output voltage should be negative full-scale – 1 LSB. A plot of zero-scale error vs. temperature can be seen in Figure 20.

### Zero-Scale TC

Zero-scale TC is a measure of the change in zero-scale error with a change in temperature. It is expressed in ppm FSR/°C.

### Output Voltage Settling Time

Output voltage settling time is the amount of time it takes for the output to settle to a specified level for a full-scale input change. A plot of full-scale settling time can be seen in Figure 25.

### Slew Rate

The slew rate of a device is a limitation in the rate of change of the output voltage. The output slewing speed of a voltage output DAC is usually limited by the slew rate of the amplifier used at its output. Slew rate is measured from 10% to 90% of the output signal and is given in V/ $\mu$ s.

### Gain Error

Gain error is a measure of the span error of the DAC. It is the deviation in slope of the DAC transfer characteristic from ideal expressed in % FSR. A plot of gain error vs. temperature can be seen in Figure 22.

### Gain TC

Gain TC is a measure of the change in gain error with changes in temperature. It is expressed in ppm FSR/°C.

### Total Unadjusted Error (TUE)

Total unadjusted error is a measure of the output error taking all the various errors into account, namely INL error, offset error, gain error, and output drift over supplies, temperature, and time. TUE is expressed in % FSR.

### Digital-to-Analog Glitch Impulse

Digital-to-analog glitch impulse is the impulse injected into the analog output when the input code in the DAC register changes state, but the output voltage remains constant. It is normally specified as the area of the glitch in nV-sec and is measured when the digital input code is changed by 1 LSB at the major carry transition (0x7FFF to 0x8000). See Figure 29.

### Glitch Impulse Peak Amplitude

Glitch impulse peak amplitude is the peak amplitude of the impulse injected into the analog output when the input code in the DAC register changes state. It is specified as the amplitude of the glitch in millivolts and is measured when the digital input code is changed by 1 LSB at the major carry transition (0x7FFF to 0x8000). See Figure 29.

### Digital Feedthrough

Digital feedthrough is a measure of the impulse injected into the analog output of the DAC from the digital inputs of the DAC but is measured when the DAC output is not updated. It is specified in nV-sec and measured with a full-scale code change on the data bus.

### Power Supply Sensitivity

Power supply sensitivity indicates how the output of the DAC is affected by changes in the power supply voltage. It is measured by superimposing a 50 Hz/60 Hz, 200 mV p-p sine wave on the supply voltages and measuring the proportion of the sine wave that transfers to the outputs.

**DC Crosstalk**

DC crosstalk is the dc change in the output level of one DAC in response to a change in the output of another DAC. It is measured with a full-scale output change on one DAC while monitoring another DAC. It is expressed in LSBs.

**Digital Crosstalk**

Digital crosstalk is a measure of the impulse injected into the analog output of one DAC from the digital inputs of another DAC but is measured when the DAC output is not updated. It is specified in nV-sec and measured with a full-scale code change on the data bus.

**DAC-to-DAC Crosstalk**

DAC-to-DAC crosstalk is the glitch impulse transferred to the output of one DAC due to a digital code change and subsequent output change of another DAC. This includes both digital and analog crosstalk. It is measured by loading one of the DACs with a full-scale code change (all 0s to all 1s and vice versa) with  $\overline{\text{LDAC}}$  low and monitoring the output of another DAC. The energy of the glitch is expressed in nV-sec.

**Voltage Reference TC**

Voltage reference TC is a measure of the change in the reference output voltage with a change in temperature. The reference TC is calculated using the box method, which defines the TC as the maximum change in the reference output over a given temperature range expressed in ppm/°C as follows;

$$TC = \left[ \frac{V_{REFmax} - V_{REFmin}}{V_{REFnom} \times TempRange} \right] \times 10^6$$

where:

$V_{REFmax}$  is the maximum reference output measured over the total temperature range.

$V_{REFmin}$  is the minimum reference output measured over the total temperature range.

$V_{REFnom}$  is the nominal reference output voltage, 2.5 V.

$TempRange$  is the specified temperature range, either 0°C to 85°C or -40°C to +85°C.

## THEORY OF OPERATION

The [AD5724R/AD5734R/AD5754R](#) are quad, 12-/14-/16-bit, serial input, unipolar/bipolar, voltage output DACs. They operate from single supply voltages of +4.5 V to +16.5 V or dual supply voltages of  $\pm 4.5$  V to  $\pm 16.5$  V. In addition, the devices have software-selectable output ranges of +5 V, +10 V, +10.8 V,  $\pm 5$  V,  $\pm 10$  V, and  $\pm 10.8$  V. Data is written to the [AD5724R/AD5734R/AD5754R](#) in a 24-bit word format via a 3-wire serial interface. The devices also offer an SDO pin to facilitate daisy chaining or readback.

The [AD5724R/AD5734R/AD5754R](#) incorporate a power-on reset circuit to ensure that the DAC registers power up loaded with 0x0000. When powered on, the outputs are clamped to 0 V via a low impedance path. The devices also feature on-chip reference and reference buffers.

## ARCHITECTURE

The DAC architecture consists of a string DAC followed by an output amplifier. Figure 44 shows a block diagram of the DAC architecture. The reference input is buffered before being applied to the DAC.

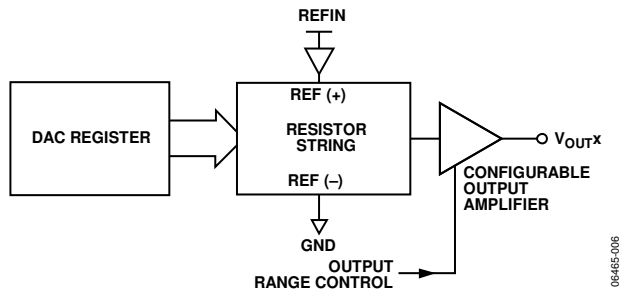

Figure 44. DAC Architecture Block Diagram

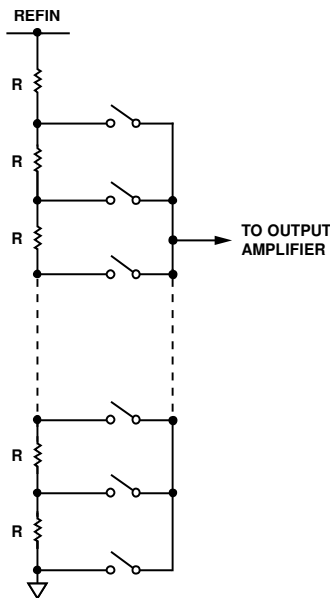

Figure 45. Resistor String Structure

The resistor string structure is shown in Figure 45. It is a string of resistors, each of value  $R$ . The code loaded to the DAC register determines the node on the string where the voltage is to be tapped off and fed into the output amplifier. The voltage is tapped off by closing one of the switches connecting the string to the amplifier. Because it is a string of resistors, it is guaranteed monotonic.

## Output Amplifiers

The output amplifiers are capable of generating both unipolar and bipolar output voltages. They are capable of driving a load of 2 k $\Omega$  in parallel with 4000 pF to GND. The source and sink capabilities of the output amplifiers can be seen in Figure 24. The slew rate is 3.5 V/ $\mu$ s with a full-scale settling time of 10  $\mu$ s.

## Reference Buffers

The [AD5724R/AD5734R/AD5754R](#) can operate with either an external or internal reference. The reference input has an input range of 2 V to 3 V with 2.5 V for specified performance. This input voltage is then buffered before it is applied to the DAC cores.

## POWER-UP SEQUENCE

Because the DAC output voltage is controlled by the voltage monitor and control block (see Figure 48), it is important to power the DV<sub>CC</sub> pin before applying any voltage to the AV<sub>DD</sub> and AV<sub>SS</sub> pins; otherwise, the G1 and G2 transmission gates are at an undefined state. The ideal power-up sequence is in the following order: GND, SIG\_GND, DAC\_GND, DV<sub>CC</sub>, AV<sub>DD</sub>, AV<sub>SS</sub>, and then the digital inputs. The relative order of powering AV<sub>DD</sub> and AV<sub>SS</sub> is not important, provided that they are powered up after DV<sub>CC</sub>.

## SERIAL INTERFACE

The [AD5724R/AD5734R/AD5754R](#) are controlled over a versatile 3-wire serial interface that operates at clock rates up to 30 MHz. It is compatible with SPI, QSPI™, MICROWIRE, and DSP standards.

## Input Shift Register

The input shift register is 24 bits wide. Data is loaded into the device MSB first as a 24-bit word under the control of a serial clock input, SCLK. The input register consists of a read/write bit, three register select bits, three DAC address bits, and 16 data bits. The timing diagram for this operation is shown in Figure 2.

**Standalone Operation**

The serial interface works with both a continuous and a noncontinuous serial clock. A continuous SCLK source can only be used if SYNC is held low for the correct number of clock cycles. In gated clock mode, a burst clock containing the exact number of clock cycles must be used, and SYNC must be taken high after the final clock to latch the data. The first falling edge of SYNC starts the write cycle. Exactly 24 falling clock edges must be applied to SCLK before SYNC is brought high again. If SYNC is brought high before the 24<sup>th</sup> falling SCLK edge, the data written is invalid. If more than 24 falling SCLK edges are applied before SYNC is brought high, the input data is also invalid. The input register addressed is updated on the rising edge of SYNC. For another serial transfer to take place, SYNC must be brought low again. After the end of the serial data transfer, data is automatically transferred from the input shift register to the addressed register.

When the data has been transferred into the chosen register of the addressed DAC, all DAC registers and outputs can be updated by taking LDAC low while SYNC is high.

**Daisy-Chain Operation**

For systems that contain several devices, the SDO pin can be used to daisy-chain several devices together. Daisy-chain mode can be useful in system diagnostics and in reducing the number of serial interface lines. The first falling edge of SYNC starts the write cycle. SCLK is continuously applied to the input shift register when SYNC is low. If more than 24 clock pulses are applied, the data ripples out of the shift register and appears on the SDO line. This data is clocked out on the rising edge of SCLK and is valid on the falling edge. By connecting the SDO of the first device to the SDIN input of the next device in the chain, a multidevice interface is constructed. Each device in the system requires 24 clock pulses. Therefore, the total number of clock cycles must equal 24 × N, where N is the total number of AD5724R/AD5734R/AD5754R devices in the chain. When the serial transfer to all devices is complete, SYNC is taken high. This latches the input data in each device in the daisy chain and prevents any further data from being clocked into the input shift register. The serial clock can be a continuous or gated clock.

A continuous SCLK source can only be used if SYNC is held low for the correct number of clock cycles. In gated clock mode, a burst clock containing the exact number of clock cycles must be used, and SYNC must be taken high after the final clock to latch the data.

**Readback Operation**

Readback mode is invoked by setting the R/W bit to 1 in the write operation to the serial input shift register. (If the SDO output is disabled via the SDO disable bit in the control register, it is automatically enabled for the duration of the read operation, after which it is disabled again.) With R/W set to 1, Bit A2 to Bit A0 in association with Bit REG2 to Bit REG0 select the register to be read. The remaining data bits in the write sequence are don't care bits. During the next SPI write, the data appearing on the SDO output contains the data from the previously addressed register. For a read of a single register, the NOP command can be used in clocking out the data from the selected register on SDO. The readback diagram in Figure 4 shows the readback sequence. For example, to read back the DAC register of Channel A, implement the following sequence:

1. Write 0x800000 to the AD5724R/AD5734R/AD5754R input register. This configures the device for read mode with the DAC register of Channel A selected. Note that all the data bits, DB15 to DB0, are don't care bits.
2. Follow this with a second write, a NOP condition, 0x180000. During this write, the data from the register is clocked out on the SDO line.

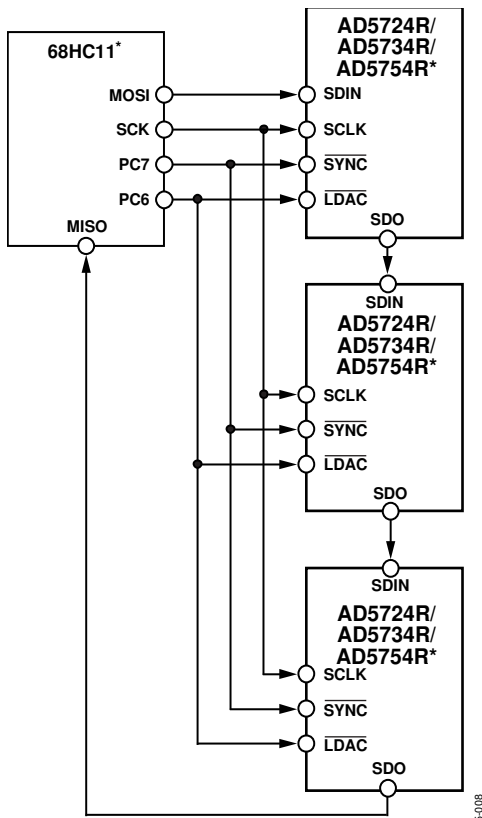

\*ADDITIONAL PINS OMITTED FOR CLARITY.

Figure 46. Daisy Chaining the AD5724R/AD5734R/AD5754R

## LOAD DAC ( $\overline{\text{LDAC}}$ )

After data has been transferred into the input register of the DACs, there are two ways to update the DAC registers and DAC outputs. Depending on the status of both  $\overline{\text{SYNC}}$  and  $\overline{\text{LDAC}}$ , one of two update modes is selected: individual DAC updating or simultaneous updating of all DACs.

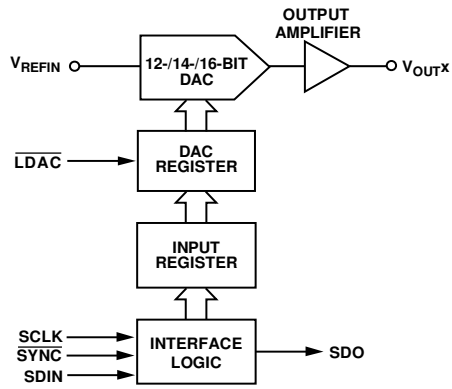

Figure 47. Simplified Diagram of Input Loading Circuitry for One DAC

### Individual DAC Updating

In this mode,  $\overline{\text{LDAC}}$  is held low while data is clocked into the input shift register. The addressed DAC output is updated on the rising edge of  $\overline{\text{SYNC}}$ .

### Simultaneous Updating of All DACs

In this mode,  $\overline{\text{LDAC}}$  is held high while data is clocked into the input shift register. All DAC outputs are asynchronously updated by taking  $\overline{\text{LDAC}}$  low after  $\overline{\text{SYNC}}$  has been taken high. The update now occurs on the falling edge of  $\overline{\text{LDAC}}$ .

## ASYNCHRONOUS CLEAR ( $\overline{\text{CLR}}$ )

$\overline{\text{CLR}}$  is an active low clear that allows the outputs to be cleared to either zero-scale code or midscale code. The clear code value is user selectable via the CLR select bit of the control register (see the Control Register section). It is necessary to keep  $\overline{\text{CLR}}$  low for a minimum amount of time to complete the operation (see Figure 2). When the  $\overline{\text{CLR}}$  signal is returned high, the output remains at the cleared value until a new value is programmed. The outputs cannot be updated with a new value while the  $\overline{\text{CLR}}$  pin is low. A clear operation can also be performed via the clear command in the control register.

## CONFIGURING THE AD5724R/AD5734R/AD5754R

When the power supplies are applied to the AD5724R/AD5734R/AD5754R, the power-on reset circuit ensures that all registers default to 0. This places all channels and the internal reference in power-down mode. Bring the  $\text{DV}_{\text{CC}}$  high before any of the interface lines are powered. If this is not done, the first write to the device may be ignored. The first communication to the AD5724R/AD5734R/AD5754R should be to set the required output range on all channels (the default range is the 5 V unipolar range) by writing to the output range select register. The user should then write to the power-control register to power-on the required channels and the internal reference, if required. If an external reference source is being used, the internal reference must remain in power-down mode. To program an output value on a channel, that channel must first be powered up; any writes to a channel while it is in power-down mode are ignored. The AD5724R/AD5734R/AD5754R operate with a wide power supply range. It is important that the power supply applied to the devices provide adequate headroom to support the chosen output ranges.

## TRANSFER FUNCTION

Table 8 to Table 16 show the relationships of the ideal input code to output voltage for the AD5754R, AD5734R, and AD5724R for all output voltage ranges. For unipolar output ranges, the data coding is straight binary. For bipolar output ranges, the data coding is user selectable via the BIN/2sCOMP pin and can be either offset binary or twos complement.

For a unipolar output range, the output voltage expression is given by

$$V_{\text{OUT}} = V_{\text{REFIN}} \times \text{Gain} \left[ \frac{D}{2^N} \right]$$

For a bipolar output range, the output voltage expression is given by

$$V_{\text{OUT}} = V_{\text{REFIN}} \times \text{Gain} \left[ \frac{D}{2^N} \right] - \frac{\text{Gain} \times V_{\text{REFIN}}}{2}$$

where:

$D$  is the decimal equivalent of the code loaded to the DAC.

$N$  is the bit resolution of the DAC.

$V_{\text{REFIN}}$  is the reference voltage applied at the REFIN pin.

$\text{Gain}$  is an internal gain the value of which depends on the output range selected by the user as shown in Table 7.

Table 7. Internal Gain Values

Output Range (V)	Gain Value
+5	2
+10	4
+10.8	4.32
±5	4
±10	8
±10.8	8.64

**Ideal Output Voltage to Input Code Relationship—AD5754R****Table 8. Bipolar Output, Offset Binary Coding**

Digital Input				Analog Output		
MSB			LSB	$\pm 5$ V Output Range	$\pm 10$ V Output Range	$\pm 10.8$ V Output Range
1111	1111	1111	1111	$+2 \times \text{REFIN} \times (32,767/32,768)$	$+4 \times \text{REFIN} \times (32,767/32,768)$	$+4.32 \times \text{REFIN} \times (32,767/32,768)$
1111	1111	1111	1110	$+2 \times \text{REFIN} \times (32,766/32,768)$	$+4 \times \text{REFIN} \times (32,766/32,768)$	$+4.32 \times \text{REFIN} \times (32,766/32,768)$
...	...	...	...	...	...	...
1000	0000	0000	0001	$+2 \times \text{REFIN} \times (1/32,768)$	$+4 \times \text{REFIN} \times (1/32,768)$	$+4.32 \times \text{REFIN} \times (1/32,768)$
1000	0000	0000	0000	0 V	0 V	0 V
0111	1111	1111	1111	$-2 \times \text{REFIN} \times (1/32,768)$	$-4 \times \text{REFIN} \times (1/32,768)$	$-4.32 \times \text{REFIN} \times (32,766/32,768)$
...	...	...	...	...	...	...
0000	0000	0000	0001	$-2 \times \text{REFIN} \times (32,767/32,768)$	$-4 \times \text{REFIN} \times (32,767/32,768)$	$-4.32 \times \text{REFIN} \times (32,767/32,768)$
0000	0000	0000	0000	$-2 \times \text{REFIN} \times (32,768/32,768)$	$-4 \times \text{REFIN} \times (32,768/32,768)$	$-4.32 \times \text{REFIN} \times (32,768/32,768)$

**Table 9. Bipolar Output, Twos Complement Coding**

Digital Input				Analog Output		
MSB			LSB	$\pm 5$ V Output Range	$\pm 10$ V Output Range	$\pm 10.8$ V Output Range
0111	1111	1111	1111	$+2 \times \text{REFIN} \times (32,767/32,768)$	$+4 \times \text{REFIN} \times (32,767/32,768)$	$+4.32 \times \text{REFIN} \times (32,767/32,768)$
0111	1111	1111	1110	$+2 \times \text{REFIN} \times (32,766/32,768)$	$+4 \times \text{REFIN} \times (32,766/32,768)$	$+4.32 \times \text{REFIN} \times (32,766/32,768)$
...	...	...	...	...	...	...
0000	0000	0000	0001	$+2 \times \text{REFIN} \times (1/32,768)$	$+4 \times \text{REFIN} \times (1/32,768)$	$+4.32 \times \text{REFIN} \times (1/32,768)$
0000	0000	0000	0000	0 V	0 V	0 V
1111	1111	1111	1111	$-2 \times \text{REFIN} \times (1/32,768)$	$-4 \times \text{REFIN} \times (1/32,768)$	$-4.32 \times \text{REFIN} \times (1/32,768)$
...	...	...	...	...	...	...
1000	0000	0000	0001	$-2 \times \text{REFIN} \times (32,767/32,768)$	$-4 \times \text{REFIN} \times (32,767/32,768)$	$-4.32 \times \text{REFIN} \times (32,767/32,768)$
1000	0000	0000	0000	$-2 \times \text{REFIN} \times (32,768/32,768)$	$-4 \times \text{REFIN} \times (32,768/32,768)$	$-4.32 \times \text{REFIN} \times (32,768/32,768)$

**Table 10. Unipolar Output, Straight Binary Coding**

Digital Input				Analog Output		
MSB			LSB	+5 V Output Range	+10 V Output Range	+10.8 V Output Range
1111	1111	1111	1111	$+2 \times \text{REFIN} \times (65,535/65,536)$	$+4 \times \text{REFIN} \times (65,535/65,536)$	$+4.32 \times \text{REFIN} \times (65,535/65,536)$
1111	1111	1111	1110	$+2 \times \text{REFIN} \times (65,534/65,536)$	$+4 \times \text{REFIN} \times (65,534/65,536)$	$+4.32 \times \text{REFIN} \times (65,534/65,536)$
...	...	...	...	...	...	...
1000	0000	0000	0001	$+2 \times \text{REFIN} \times (32,769/65,536)$	$+4 \times \text{REFIN} \times (32,769/65,536)$	$+4.32 \times \text{REFIN} \times (32,769/65,536)$
1000	0000	0000	0000	$+2 \times \text{REFIN} \times (32,768/65,536)$	$+4 \times \text{REFIN} \times (32,768/65,536)$	$+4.32 \times \text{REFIN} \times (32,768/65,536)$
0111	1111	1111	1111	$+2 \times \text{REFIN} \times (32,767/65,536)$	$+4 \times \text{REFIN} \times (32,767/65,536)$	$+4.32 \times \text{REFIN} \times (32,767/65,536)$
...	...	...	...	...	...	...
0000	0000	0000	0001	$+2 \times \text{REFIN} \times (1/65,536)$	$+4 \times \text{REFIN} \times (1/65,536)$	$+4.32 \times \text{REFIN} \times (1/65,536)$
0000	0000	0000	0000	0 V	0 V	0 V



**Ideal Output Voltage to Input Code Relationship—AD5734R**

**Table 11. Bipolar Output, Offset Binary Coding**

Digital Input				Analog Output		
MSB			LSB	±5 V Output Range	±10 V Output Range	±10.8 V Output Range
11	1111	1111	1111	$+2 \times \text{REFIN} \times (8191/8192)$	$+4 \times \text{REFIN} \times (8191/8192)$	$+4.32 \times \text{REFIN} \times (8191/8192)$
11	1111	1111	1110	$+2 \times \text{REFIN} \times (8190/8192)$	$+4 \times \text{REFIN} \times (8190/8192)$	$+4.32 \times \text{REFIN} \times (8190/8192)$
...	...	...	...	...	...	...
10	0000	0000	0001	$+2 \times \text{REFIN} \times (1/8192)$	$+4 \times \text{REFIN} \times (1/8192)$	$+4.32 \times \text{REFIN} \times (1/8192)$
10	0000	0000	0000	0 V	0 V	0 V
01	1111	1111	1111	$-2 \times \text{REFIN} \times (1/8192)$	$-4 \times \text{REFIN} \times (1/8192)$	$-4.32 \times \text{REFIN} \times (1/8192)$
...	...	...	...	...	...	...
00	0000	0000	0001	$-2 \times \text{REFIN} \times (8191/8192)$	$-4 \times \text{REFIN} \times (8191/8192)$	$-4.32 \times \text{REFIN} \times (8191/8192)$
00	0000	0000	0000	$-2 \times \text{REFIN} \times (8192/8192)$	$-4 \times \text{REFIN} \times (8192/8192)$	$-4.32 \times \text{REFIN} \times (8192/8192)$

**Table 12. Bipolar Output, Twos Complement Coding**

Digital Input				Analog Output		
MSB			LSB	±5 V Output Range	±10 V Output Range	±10.8 V Output Range
01	1111	1111	1111	$+2 \times \text{REFIN} \times (8191/8192)$	$+4 \times \text{REFIN} \times (8191/8192)$	$+4.32 \times \text{REFIN} \times (8191/8192)$
01	1111	1111	1110	$+2 \times \text{REFIN} \times (8190/8192)$	$+4 \times \text{REFIN} \times (8190/8192)$	$+4.32 \times \text{REFIN} \times (8190/8192)$
...	...	...	...	...	...	...
00	0000	0000	0001	$+2 \times \text{REFIN} \times (1/8192)$	$+4 \times \text{REFIN} \times (1/8192)$	$+4.32 \times \text{REFIN} \times (1/8192)$
00	0000	0000	0000	0 V	0 V	0 V
11	1111	1111	1111	$-2 \times \text{REFIN} \times (1/8192)$	$-4 \times \text{REFIN} \times (1/8192)$	$-4.32 \times \text{REFIN} \times (1/8192)$
...	...	...	...	...	...	...
10	0000	0000	0001	$-2 \times \text{REFIN} \times (8191/8192)$	$-4 \times \text{REFIN} \times (8191/8192)$	$-4.32 \times \text{REFIN} \times (8191/8192)$
10	0000	0000	0000	$-2 \times \text{REFIN} \times (8192/8192)$	$-4 \times \text{REFIN} \times (8192/8192)$	$-4.32 \times \text{REFIN} \times (8192/8192)$

**Table 13. Unipolar Output, Straight Binary Coding**

Digital Input				Analog Output		
MSB			LSB	+5 V Output Range	+10 V Output Range	+10.8 V Output Range
11	1111	1111	1111	$+2 \times \text{REFIN} \times (16,383/16,384)$	$+4 \times \text{REFIN} \times (16,383/16,384)$	$+4.32 \times \text{REFIN} \times (16,383/16,384)$
11	1111	1111	1110	$+2 \times \text{REFIN} \times (16,382/16,384)$	$+4 \times \text{REFIN} \times (16,382/16,384)$	$+4.32 \times \text{REFIN} \times (16,382/16,384)$
...	...	...	...	...	...	...
10	0000	0000	0001	$+2 \times \text{REFIN} \times (8193/16,384)$	$+4 \times \text{REFIN} \times (8193/16,384)$	$+4.32 \times \text{REFIN} \times (8193/16,384)$
10	0000	0000	0000	$+2 \times \text{REFIN} \times (8192/16,384)$	$+4 \times \text{REFIN} \times (8192/16,384)$	$+4.32 \times \text{REFIN} \times (8192/16,384)$
01	1111	1111	1111	$+2 \times \text{REFIN} \times (8191/16,384)$	$+4 \times \text{REFIN} \times (8191/16,384)$	$+4.32 \times \text{REFIN} \times (8191/16,384)$
...	...	...	...	...	...	...
00	0000	0000	0001	$+2 \times \text{REFIN} \times (1/16,384)$	$+4 \times \text{REFIN} \times (1/16,384)$	$+4.32 \times \text{REFIN} \times (1/16,384)$
00	0000	0000	0000	0 V	0 V	0 V

**Ideal Output Voltage to Input Code Relationship—AD5724R****Table 14. Bipolar Output, Offset Binary Coding**

Digital Input			Analog Output		
MSB	LSB		$\pm 5$ V Output Range	$\pm 10$ V Output Range	$\pm 10.8$ V Output Range
1111	1111	1111	$+2 \times \text{REFIN} \times (2047/2048)$	$+4 \times \text{REFIN} \times (2047/2048)$	$+4.32 \times \text{REFIN} \times (2047/2048)$
1111	1111	1110	$+2 \times \text{REFIN} \times (2046/2048)$	$+4 \times \text{REFIN} \times (2046/2048)$	$+4.32 \times \text{REFIN} \times (2046/2048)$
...	...	...	...	...	...
1000	0000	0001	$+2 \times \text{REFIN} \times (1/2048)$	$+4 \times \text{REFIN} \times (1/2048)$	$+4.32 \times \text{REFIN} \times (1/2048)$
1000	0000	0000	0 V	0 V	0 V
0111	1111	1111	$-2 \times \text{REFIN} \times (1/2048)$	$-4 \times \text{REFIN} \times (1/2048)$	$-4.32 \times \text{REFIN} \times (1/2048)$
...	...	...	...	...	...
0000	0000	0001	$-2 \times \text{REFIN} \times (2047/2048)$	$-4 \times \text{REFIN} \times (2047/2048)$	$-4.32 \times \text{REFIN} \times (2047/2048)$
0000	0000	0000	$-2 \times \text{REFIN} \times (2048/2048)$	$-4 \times \text{REFIN} \times (2048/2048)$	$-4.32 \times \text{REFIN} \times (2048/2048)$

**Table 15. Bipolar Output, Twos Complement Coding**

Digital Input			Analog Output		
MSB	LSB		$\pm 5$ V Output Range	$\pm 10$ V Output Range	$\pm 10.8$ V Output Range
0111	1111	1111	$+2 \times \text{REFIN} \times (2047/2048)$	$+4 \times \text{REFIN} \times (2047/2048)$	$+4.32 \times \text{REFIN} \times (2047/2048)$
0111	1111	1110	$+2 \times \text{REFIN} \times (2046/2048)$	$+4 \times \text{REFIN} \times (2046/2048)$	$+4.32 \times \text{REFIN} \times (2046/2048)$
...	...	...	...	...	...
0000	0000	0001	$+2 \times \text{REFIN} \times (1/2048)$	$+4 \times \text{REFIN} \times (1/2048)$	$+4.32 \times \text{REFIN} \times (1/2048)$
0000	0000	0000	0 V	0 V	0 V
1111	1111	1111	$-2 \times \text{REFIN} \times (1/2048)$	$-4 \times \text{REFIN} \times (1/2048)$	$-4.32 \times \text{REFIN} \times (1/2048)$
...	...	...	...	...	...
1000	0000	0001	$-2 \times \text{REFIN} \times (2047/2048)$	$-4 \times \text{REFIN} \times (2047/2048)$	$-4.32 \times \text{REFIN} \times (2047/2048)$
1000	0000	0000	$-2 \times \text{REFIN} \times (2048/2048)$	$-4 \times \text{REFIN} \times (2048/2048)$	$-4.32 \times \text{REFIN} \times (2048/2048)$

**Table 16. Unipolar Output, Straight Binary Coding**

Digital Input			Analog Output		
MSB	LSB		+5 V Output Range	+10 V Output Range	+10.8 V Output Range
1111	1111	1111	$+2 \times \text{REFIN} \times (4095/4096)$	$+4 \times \text{REFIN} \times (4095/4096)$	$+4.32 \times \text{REFIN} \times (4095/4096)$
1111	1111	1110	$+2 \times \text{REFIN} \times (4094/4096)$	$+4 \times \text{REFIN} \times (4094/4096)$	$+4.32 \times \text{REFIN} \times (4094/4096)$
...	...	...	...	...	...
1000	0000	0001	$+2 \times \text{REFIN} \times (2049/4096)$	$+4 \times \text{REFIN} \times (2049/4096)$	$+4.32 \times \text{REFIN} \times (2049/4096)$
1000	0000	0000	$+2 \times \text{REFIN} \times (2048/4096)$	$+4 \times \text{REFIN} \times (2048/4096)$	$+4.32 \times \text{REFIN} \times (2048/4096)$
0111	1111	1111	$+2 \times \text{REFIN} \times (2047/4096)$	$+4 \times \text{REFIN} \times (2047/4096)$	$+4.32 \times \text{REFIN} \times (2047/4096)$
...	...	...	...	...	...
0000	0000	0001	$+2 \times \text{REFIN} \times (1/4096)$	$+4 \times \text{REFIN} \times (1/4096)$	$+4.32 \times \text{REFIN} \times (1/4096)$
0000	0000	0000	0 V	0 V	0 V