



Chipsmall Limited consists of a professional team with an average of over 10 year of expertise in the distribution of electronic components. Based in Hongkong, we have already established firm and mutual-benefit business relationships with customers from,Europe,America and south Asia,supplying obsolete and hard-to-find components to meet their specific needs.

With the principle of "Quality Parts,Customers Priority,Honest Operation,and Considerate Service",our business mainly focus on the distribution of electronic components. Line cards we deal with include Microchip,ALPS,ROHM,Xilinx,Pulse,ON,Everlight and Freescale. Main products comprise IC,Modules,Potentiometer,IC Socket,Relay,Connector.Our parts cover such applications as commercial,industrial, and automotives areas.

We are looking forward to setting up business relationship with you and hope to provide you with the best service and solution. Let us make a better world for our industry!



Contact us

Tel: +86-755-8981 8866 Fax: +86-755-8427 6832

Email & Skype: info@chipsmall.com Web: www.chipsmall.com

Address: A1208, Overseas Decoration Building, #122 Zhenhua RD., Futian, Shenzhen, China



FEATURES

- 1.6 GHz differential clock input**
- 3 programmable dividers**
 - Divide-by in range from 1 to 32
 - Phase select for coarse delay adjust
- 2 independent 1.6 GHz LVPECL clock outputs**
 - Additive broadband output jitter 225 fs rms
- 1 independent 800 MHz/250 MHz LVDS/CMOS clock output**
 - Additive broadband output jitter 300 fs rms/290 fs rms
 - Time delays up to 10 ns
- Device configured with 4-level logic pins
- Space-saving, 32-lead LFCSP

APPLICATIONS

- Low jitter, low phase noise clock distribution
- Clocking high speed ADCs, DACs, DDSs, DDCs, DUCs, MxFEs
- High performance wireless transceivers
- High performance instrumentation
- Broadband infrastructure
- ATE

GENERAL DESCRIPTION

The AD9514 features a multi-output clock distribution IC in a design that emphasizes low jitter and phase noise to maximize data converter performance. Other applications with demanding phase noise and jitter requirements also benefit from this part.

There are three independent clock outputs. Two of the outputs are LVPECL, and the third output can be set to either LVDS or CMOS levels. The LVPECL outputs operate to 1.6 GHz, and the third output operates to 800 MHz in LVDS mode and to 250 MHz in CMOS mode.

Each output has a programmable divider that can be set to divide by a selected set of integers ranging from 1 to 32. The phase of one clock output relative to another clock output can be set by means of a divider phase select function that serves as a coarse timing adjustment.

FUNCTIONAL BLOCK DIAGRAM

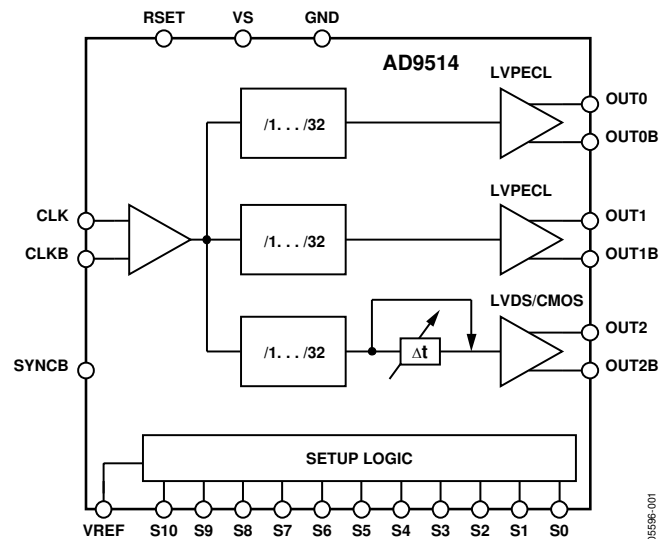

Figure 1.

The LVDS/CMOS output features a delay element with three selectable full-scale delay values (1.5 ns, 5 ns, and 10 ns), each with 16 steps of fine adjustment.

The AD9514 does not require an external controller for operation or setup. The device is programmed by means of 11 pins (S0 to S10) using 4-level logic. The programming pins are internally biased to $\frac{1}{3} V_s$. The VREF pin provides a level of $\frac{2}{3} V_s$. V_s (3.3 V) and GND (0 V) provide the other two logic levels.

The AD9514 is ideally suited for data converter clocking applications where maximum converter performance is achieved by encode signals with subpicosecond jitter.

The AD9514 is available in a 32-lead LFCSP and operates from a single 3.3 V supply. The temperature range is -40°C to $+85^{\circ}\text{C}$.

Rev. 0

Information furnished by Analog Devices is believed to be accurate and reliable. However, no responsibility is assumed by Analog Devices for its use, nor for any infringements of patents or other rights of third parties that may result from its use. Specifications subject to change without notice. No license is granted by implication or otherwise under any patent or patent rights of Analog Devices. Trademarks and registered trademarks are the property of their respective owners.

AD9514* PRODUCT PAGE QUICK LINKS

Last Content Update: 02/23/2017

COMPARABLE PARTS

View a parametric search of comparable parts.

EVALUATION KITS

- AD9514 Evaluation Board

DOCUMENTATION

Application Notes

- AN-0974: Multicarrier TD-SCMA Feasibility
- AN-501: Aperture Uncertainty and ADC System Performance
- AN-741: Little Known Characteristics of Phase Noise
- AN-756: Sampled Systems and the Effects of Clock Phase Noise and Jitter
- AN-769: Generating Multiple Clock Outputs from the AD9540
- AN-823: Direct Digital Synthesizers in Clocking Applications Time
- AN-837: DDS-Based Clock Jitter Performance vs. DAC Reconstruction Filter Performance
- AN-873: Lock Detect on the ADF4xxx Family of PLL Synthesizers
- AN-927: Determining if a Spur is Related to the DDS/DAC or to Some Other Source (For Example, Switching Supplies)
- AN-939: Super-Nyquist Operation of the AD9912 Yields a High RF Output Signal

Data Sheet

- AD9514: 1.6 GHz Clock Distribution IC, Dividers, Delay Adjust, Three Output Data Sheet

TOOLS AND SIMULATIONS

- ADIsimCLK Design and Evaluation Software
- AD9514 IBIS Models

REFERENCE DESIGNS

- CN0109

REFERENCE MATERIALS

Press

- Analog Devices' Dual 14-bit A/D Converter Reduces Power and Size in Communications, Instrumentation, Test and Measurement Applications

Technical Articles

- ADI Buys Korean Mobile TV Chip Maker
- Design A Clock-Distribution Strategy With Confidence
- Improved DDS Devices Enable Advanced Comm Systems
- Low-power direct digital synthesizer cores enable high level of integration
- Speedy A/Ds Demand Stable Clocks
- Understand the Effects of Clock Jitter and Phase Noise on Sampled Systems

DESIGN RESOURCES

- AD9514 Material Declaration
- PCN-PDN Information
- Quality And Reliability
- Symbols and Footprints

DISCUSSIONS

View all AD9514 EngineerZone Discussions.

SAMPLE AND BUY

Visit the product page to see pricing options.

TECHNICAL SUPPORT

Submit a technical question or find your regional support number.

DOCUMENT FEEDBACK

Submit feedback for this data sheet.

TABLE OF CONTENTS

Features	1	Power-On SYNC	18
Applications.....	1	SYNCB.....	18
Functional Block Diagram	1	R _{SET} Resistor	19
General Description	1	VREF.....	19
Revision History	2	Setup Configuration.....	19
Specifications.....	3	Divider Phase Offset	22
Clock Input.....	3	Delay Block	22
Clock Outputs.....	3	Outputs	23
Timing Characteristics	4	Power Supply.....	23
Clock Output Phase Noise	5	Exposed Metal Paddle	24
Clock Output Additive Time Jitter.....	8	Power Management	24
SYNCB, VREF, and Setup Pins.....	10	Applications.....	25
Power.....	10	Using the AD9514 Outputs for ADC Clock Applications....	25
Timing Diagrams.....	11	LVPECL Clock Distribution	25
Absolute Maximum Ratings.....	12	LVDS Clock Distribution	26
Thermal Characteristics	12	CMOS Clock Distribution	26
ESD Caution.....	12	Setup Pins (S0 to S10).....	26
Pin Configuration and Function Descriptions.....	13	Power and Grounding Considerations and Power Supply Rejection.....	26
Terminology	14	Phase Noise and Jitter Measurement Setups.....	27
Typical Performance Characteristics	15	Outline Dimensions	28
Functional Description	18	Ordering Guide	28
Overall.....	18		
CLK, CLKB—Differential Clock Input	18		
Synchronization	18		

REVISION HISTORY

7/05—Revision 0: Initial Version

SPECIFICATIONS

Typical (typ) is given for $V_S = 3.3 \text{ V} \pm 5\%$, $T_A = 25^\circ\text{C}$, $R_{\text{SET}} = 4.12 \text{ k}\Omega$, LVPECL $V_{\text{OD}} = 790 \text{ mV}$, unless otherwise noted. Minimum (min) and maximum (max) values are given over full V_S and T_A (-40°C to $+85^\circ\text{C}$) variation.

CLOCK INPUT

Table 1.

Parameter	Min	Typ	Max	Unit	Test Conditions/Comments
CLOCK INPUT (CLK)					
Input Frequency ¹	0		1.6	GHz	
Input Sensitivity ¹		150		mV p-p	
Input Common-Mode Voltage, V_{CM}	1.5	1.6	1.7	V	Self-biased; enables ac coupling
Input Common-Mode Range, V_{CMR}	1.3		1.8	V	With 200 mV p-p signal applied; dc-coupled
Input Sensitivity, Single-Ended		150		mV p-p	CLK ac-coupled; CLKB ac-bypassed to RF ground
Input Resistance	4.0	4.8	5.6	k Ω	Self-biased
Input Capacitance		2		pF	

¹ A slew rate of 1 V/ns is required to meet jitter, phase noise, and propagation delay specifications.

CLOCK OUTPUTS

Table 2.

Parameter	Min	Typ	Max	Unit	Test Conditions/Comments
LVPECL CLOCK OUTPUTS (OUT0, OUT1) Differential					Termination = 50 Ω to $V_S - 2 \text{ V}$
Output Frequency	0		1.6	GHz	
Output High Voltage (V_{OH})	$V_S - 1.1$	$V_S - 0.96$	$V_S - 0.82$	V	
Output Low Voltage (V_{OL})	$V_S - 1.90$	$V_S - 1.76$	$V_S - 1.52$	V	
Output Differential Voltage (V_{OD})	640	790	960	mV	
LVDS CLOCK OUTPUT (OUT2) Differential					Termination = 100 Ω differential
Output Frequency	0		800	MHz	
Differential Output Voltage (V_{OD})	250	350	450	mV	
Delta V_{OD}			30	mV	
Output Offset Voltage (V_{OS})	1.125	1.23	1.375	V	
Delta V_{OS}			25	mV	
Short-Circuit Current (I_{SA} , I_{SB})		14	24	mA	Output shorted to GND
CMOS CLOCK OUTPUT (OUT2) Single-Ended					Single-ended measurements; termination open Complementary output on (OUT2B)
Output Frequency	0		250	MHz	With 5 pF load
Output Voltage High (V_{OH})	$V_S - 0.1$			V	@ 1 mA load
Output Voltage Low (V_{OL})			0.1	V	@ 1 mA load

AD9514

TIMING CHARACTERISTICS

CLK input slew rate = 1 V/ns or greater.

Table 3.

Parameter	Min	Typ	Max	Unit	Test Conditions/Comments
LVPECL					Termination = 50 Ω to V _S – 2 V
Output Rise Time, t _{RP}		60	100	ps	20% to 80%, measured differentially
Output Fall Time, t _{FP}		60	100	ps	80% to 20%, measured differentially
PROPAGATION DELAY, t _{PECL} , CLK-TO-LVPECL OUT					
Divide = 1	355	480	635	ps	
Divide = 2 – 32	395	530	710	ps	
Variation with Temperature		0.5		ps/°C	
OUTPUT SKEW, LVPECL					
OUT0 to OUT1 on Same Part, t _{SKP} ¹	–50	0	+55	ps	
Both LVPECL Outputs Across Multiple Parts, t _{SKP_AB} ²			125	ps	
Same LVPECL Output Across Multiple Parts, t _{SKP_AB} ²			125	ps	
LVDS					Termination = 100 Ω differential, 3.5 mA
Output Rise Time, t _{RL}		200	350	ps	20% to 80%, measured differentially
Output Fall Time, t _{FL}		210	350	ps	80% to 20%, measured differentially
PROPAGATION DELAY, t _{LVDS} , CLK-TO-LVDS OUT					Optional delay off
Divide = 1	1.00	1.25	1.55	ns	
Divide = 2 – 32	1.05	1.30	1.60	ns	
Variation with Temperature		0.9		ps/°C	
OUTPUT SKEW, LVDS					Optional delay off
LVDS Output Across Multiple Parts, t _{SKV_AB} ²			230	ps	
CMOS					B outputs are inverted; termination = open
Output Rise Time, t _{RC}		650	865	ps	20% to 80%; C _{LOAD} = 3 pF single-ended
Output Fall Time, t _{FC}		650	990	ps	80% to 20%; C _{LOAD} = 3 pF single-ended
PROPAGATION DELAY, t _{CMOS} , CLK-TO-CMOS OUT					Optional delay off
Divide = 1	1.10	1.45	1.75	ns	
Divide = 2 – 32	1.15	1.50	1.80	ns	
Variation with Temperature		1		ps/°C	
OUTPUT SKEW, CMOS					Optional delay off
CMOS Output Across Multiple Parts, t _{SKC_AB} ²			300	ps	
LVPECL-TO-LVDS OUT					
Output Delay, t _{SKV_C}	560	790	950	ps	
LVPECL-TO-CMOS OUT					
Output Delay, t _{SKV_C}	700	970	1150	ps	
DELAY ADJUST (OUT2; LVDS and CMOS)					
S0 = 1/3					
Zero Scale Delay Time ³		0.34		ns	
Zero Scale Variation with Temperature		0.20		ps/°C	
Full Scale Time Delay ³		1.7		ns	
Full Scale Variation with Temperature		–0.38		ps/°C	
S0 = 2/3					
Zero Scale Delay Time ³		0.45		ns	
Zero Scale Variation with Temperature		0.31		ps/°C	
Full Scale Time Delay ³		5.9		ns	
Full Scale Variation with Temperature		–1.3		ps/°C	

Parameter	Min	Typ	Max	Unit	Test Conditions/Comments
S0 = 1					
Zero Scale Delay Time ³		0.56		ns	
Zero Scale Variation with Temperature		0.47		ps/°C	
Full Scale Time Delay ³		11.4		ns	
Full Scale Variation with Temperature		-5		ps/°C	
Linearity, DNL		0.2		LSB	
Linearity, INL		0.2		LSB	

¹ This is the difference between any two similar delay paths within a single device operating at the same voltage and temperature.

² This is the difference between any two similar delay paths across multiple devices operating at the same voltage and temperature.

³ Incremental delay; does not include propagation delay.

CLOCK OUTPUT PHASE NOISE

CLK input slew rate = 1 V/ns or greater.

Table 4.

Parameter	Min	Typ	Max	Unit	Test Conditions/Comments
CLK-TO-LVPECL ADDITIVE PHASE NOISE					
CLK = 622.08 MHz, OUT = 622.08 MHz					
Divide = 1					
@ 10 Hz Offset		-125		dBc/Hz	
@ 100 Hz Offset		-132		dBc/Hz	
@ 1 kHz Offset		-140		dBc/Hz	
@ 10 kHz Offset		-148		dBc/Hz	
@ 100 kHz Offset		-153		dBc/Hz	
>1 MHz Offset		-154		dBc/Hz	
CLK = 622.08 MHz, OUT = 155.52 MHz					
Divide = 4					
@ 10 Hz Offset		-128		dBc/Hz	
@ 100 Hz Offset		-140		dBc/Hz	
@ 1 kHz Offset		-148		dBc/Hz	
@ 10 kHz Offset		-155		dBc/Hz	
@ 100 kHz Offset		-161		dBc/Hz	
>1 MHz Offset		-161		dBc/Hz	
CLK = 622.08 MHz, OUT = 38.88 MHz					
Divide = 16					
@ 10 Hz Offset		-135		dBc/Hz	
@ 100 Hz Offset		-145		dBc/Hz	
@ 1 kHz Offset		-158		dBc/Hz	
@ 10 kHz Offset		-165		dBc/Hz	
@ 100 kHz Offset		-165		dBc/Hz	
>1 MHz Offset		-166		dBc/Hz	
CLK = 491.52 MHz, OUT = 61.44 MHz					
Divide = 8					
@ 10 Hz Offset		-131		dBc/Hz	
@ 100 Hz Offset		-142		dBc/Hz	
@ 1 kHz Offset		-153		dBc/Hz	
@ 10 kHz Offset		-160		dBc/Hz	
@ 100 kHz Offset		-165		dBc/Hz	
>1 MHz Offset		-165		dBc/Hz	

AD9514

Parameter	Min	Typ	Max	Unit	Test Conditions/Comments
CLK = 491.52 MHz, OUT = 245.76 MHz					
Divide = 2					
@ 10 Hz Offset		-125		dBc/Hz	
@ 100 Hz Offset		-132		dBc/Hz	
@ 1 kHz Offset		-140		dBc/Hz	
@ 10 kHz Offset		-151		dBc/Hz	
@ 100 kHz Offset		-157		dBc/Hz	
>1 MHz Offset		-158		dBc/Hz	
CLK = 245.76 MHz, OUT = 61.44 MHz					
Divide = 4					
@ 10 Hz Offset		-138		dBc/Hz	
@ 100 Hz Offset		-144		dBc/Hz	
@ 1 kHz Offset		-154		dBc/Hz	
@ 10 kHz Offset		-163		dBc/Hz	
@ 100 kHz Offset		-164		dBc/Hz	
>1 MHz Offset		-165		dBc/Hz	
CLK-TO-LVDS ADDITIVE PHASE NOISE					
CLK = 622.08 MHz, OUT = 622.08 MHz					
Divide = 1					
@ 10 Hz Offset		-100		dBc/Hz	
@ 100 Hz Offset		-110		dBc/Hz	
@ 1 kHz Offset		-118		dBc/Hz	
@ 10 kHz Offset		-129		dBc/Hz	
@ 100 kHz Offset		-135		dBc/Hz	
@ 1 MHz Offset		-140		dBc/Hz	
>10 MHz Offset		-148		dBc/Hz	
CLK = 622.08 MHz, OUT = 155.52 MHz					
Divide = 4					
@ 10 Hz Offset		-112		dBc/Hz	
@ 100 Hz Offset		-122		dBc/Hz	
@ 1 kHz Offset		-132		dBc/Hz	
@ 10 kHz Offset		-142		dBc/Hz	
@ 100 kHz Offset		-148		dBc/Hz	
@ 1 MHz Offset		-152		dBc/Hz	
>10 MHz Offset		-155		dBc/Hz	
CLK = 491.52 MHz, OUT = 245.76 MHz					
Divide = 2					
@ 10 Hz Offset		-108		dBc/Hz	
@ 100 Hz Offset		-118		dBc/Hz	
@ 1 kHz Offset		-128		dBc/Hz	
@ 10 kHz Offset		-138		dBc/Hz	
@ 100 kHz Offset		-145		dBc/Hz	
@ 1 MHz Offset		-148		dBc/Hz	
>10 MHz Offset		-154		dBc/Hz	

Parameter	Min	Typ	Max	Unit	Test Conditions/Comments
CLK = 491.52 MHz, OUT = 122.88 MHz Divide = 4					
@ 10 Hz Offset		-118		dBc/Hz	
@ 100 Hz Offset		-129		dBc/Hz	
@ 1 kHz Offset		-136		dBc/Hz	
@ 10 kHz Offset		-147		dBc/Hz	
@ 100 kHz Offset		-153		dBc/Hz	
@ 1 MHz Offset		-156		dBc/Hz	
>10 MHz Offset		-158		dBc/Hz	
CLK = 245.76 MHz, OUT = 245.76 MHz Divide = 1					
@ 10 Hz Offset		-108		dBc/Hz	
@ 100 Hz Offset		-118		dBc/Hz	
@ 1 kHz Offset		-128		dBc/Hz	
@ 10 kHz Offset		-138		dBc/Hz	
@ 100 kHz Offset		-145		dBc/Hz	
@ 1 MHz Offset		-148		dBc/Hz	
>10 MHz Offset		-155		dBc/Hz	
CLK = 245.76 MHz, OUT = 122.88 MHz Divide = 2					
@ 10 Hz Offset		-118		dBc/Hz	
@ 100 Hz Offset		-127		dBc/Hz	
@ 1 kHz Offset		-137		dBc/Hz	
@ 10 kHz Offset		-147		dBc/Hz	
@ 100 kHz Offset		-154		dBc/Hz	
@ 1 MHz Offset		-156		dBc/Hz	
>10 MHz Offset		-158		dBc/Hz	
CLK-TO-CMOS ADDITIVE PHASE NOISE					
CLK = 245.76 MHz, OUT = 245.76 MHz Divide = 1					
@ 10 Hz Offset		-110		dBc/Hz	
@ 100 Hz Offset		-121		dBc/Hz	
@ 1 kHz Offset		-130		dBc/Hz	
@ 10 kHz Offset		-140		dBc/Hz	
@ 100 kHz Offset		-145		dBc/Hz	
@ 1 MHz Offset		-149		dBc/Hz	
>10 MHz Offset		-156		dBc/Hz	
CLK = 245.76 MHz, OUT = 61.44 MHz Divide = 4					
@ 10 Hz Offset		-125		dBc/Hz	
@ 100 Hz Offset		-132		dBc/Hz	
@ 1 kHz Offset		-143		dBc/Hz	
@ 10 kHz Offset		-152		dBc/Hz	
@ 100 kHz Offset		-158		dBc/Hz	
@ 1 MHz Offset		-160		dBc/Hz	
>10 MHz Offset		-162		dBc/Hz	

AD9514

Parameter	Min	Typ	Max	Unit	Test Conditions/Comments
CLK = 78.6432 MHz, OUT = 78.6432 MHz Divide = 1					
@ 10 Hz Offset		-122		dBc/Hz	
@ 100 Hz Offset		-132		dBc/Hz	
@ 1 kHz Offset		-140		dBc/Hz	
@ 10 kHz Offset		-150		dBc/Hz	
@ 100 kHz Offset		-155		dBc/Hz	
@ 1 MHz Offset		-158		dBc/Hz	
>10 MHz Offset		-160		dBc/Hz	
CLK = 78.6432 MHz, OUT = 39.3216 MHz Divide = 2					
@ 10 Hz Offset		-128		dBc/Hz	
@ 100 Hz Offset		-136		dBc/Hz	
@ 1 kHz Offset		-146		dBc/Hz	
@ 10 kHz Offset		-155		dBc/Hz	
@ 100 kHz Offset		-161		dBc/Hz	
>1 MHz Offset		-162		dBc/Hz	

CLOCK OUTPUT ADDITIVE TIME JITTER

Table 5.

Parameter	Min	Typ	Max	Unit	Test Conditions/Comments
LVPECL OUTPUT ADDITIVE TIME JITTER					
CLK = 622.08 MHz LVPECL (OUT0 and OUT1) = 622.08 MHz Divide = 1		40		fs rms	BW = 12 kHz – 20 MHz OUT2 off
CLK = 622.08 MHz LVPECL (OUT0 and OUT1) = 155.52 MHz Divide = 4		55		fs rms	BW = 12 kHz – 20 MHz OUT2 off
CLK = 400 MHz LVPECL (OUT0 and OUT1) = 100 MHz Divide = 4		215		fs rms	Calculated from SNR of ADC method; OUT2 off
CLK = 400 MHz LVPECL (OUT0, OUT1) = 100 MHz Divide = 4		215		fs rms	Calculated from SNR of ADC method; Other LVPECL and OUT2 LVDS at same frequency
CLK = 400 MHz LVPECL (OUT0 or OUT1) = 100 MHz Divide = 4 Other LVPECL = 50 MHz LVDS (OUT2) = 50 MHz		225		fs rms	Calculated from SNR of ADC method; Interferer Interferer
CLK = 400 MHz LVPECL (OUT0 or OUT1) = 100 MHz Divide = 4 Other LVPECL = 50 MHz CMOS (OUT2) = 50 MHz		230		fs rms	Calculated from SNR of ADC method; Interferer Interferer
LVDS OUTPUT ADDITIVE TIME JITTER					Delay off
CLK = 400 MHz LVDS (OUT2) = 100 MHz Divide = 4		300		fs rms	Calculated from SNR of ADC method; OUT0 at same frequency; OUT1 off

Parameter	Min	Typ	Max	Unit	Test Conditions/Comments
CLK = 400 MHz LVDS (OUT2) = 100 MHz Divide = 4 Both LVPECL = 50 MHz		350		fs rms	Calculated from SNR of ADC method Interferer(s)
CMOS OUTPUT ADDITIVE TIME JITTER					Delay off
CLK = 400 MHz CMOS (OUT2) = 100 MHz Divide = 4		290		fs rms	Calculated from SNR of ADC method OUT0 at same frequency; OUT1 off
CLK = 400 MHz CMOS (OUT2) = 100 MHz Divide = 4 Both LVPECL = 50 MHz		315		fs rms	Calculated from SNR of ADC method Interferer(s)
DELAY BLOCK ADDITIVE TIME JITTER ¹					100 MHz output; incremental additive jitter
Delay FS = 1.5 ns Fine Adj. 00000		0.71		ps rms	
Delay FS = 1.5 ns Fine Adj. 11111		1.2		ps rms	
Delay FS = 5 ns Fine Adj. 00000		1.3		ps rms	
Delay FS = 5 ns Fine Adj. 11111		2.7		ps rms	
Delay FS = 10 ns Fine Adj. 00000		2.0		ps rms	
Delay FS = 10 ns Fine Adj. 11111		2.8		ps rms	

¹ This value is incremental. That is, it is in addition to the jitter of the LVDS or CMOS output without the delay. To estimate the total jitter, the LVDS or CMOS output jitter should be added to this value using the root sum of the squares (RSS) method.

AD9514

SYNCB, VREF, AND SETUP PINS

Table 6.

Parameter	Min	Typ	Max	Unit	Test Conditions/Comments
SYNCB					
Logic High	2.7			V	
Logic Low			0.40	V	
Capacitance		2		pF	
VREF					
Output Voltage	0.62 V _S		0.76 V _S	V	Minimum – maximum from 0 mA to 1 mA load
S0 TO S10					
Levels					
0			0.1 V _S	V	
1/3	0.2 V _S		0.45 V _S	V	
2/3	0.55 V _S		0.8 V _S	V	
1	0.9 V _S			V	

POWER

Table 7.

Parameter	Min	Typ	Max	Unit	Test Conditions/Comments
POWER-ON SYNCHRONIZATION ¹ V _S Transit Time from 2.2 V to 3.1 V			35	ms	See Figure 24.
POWER DISSIPATION	295	405	550	mW	All outputs on. 2 LVPECL (divide = 2), 1 LVDS (divide = 2). No clock. Does not include power dissipated in external resistors.
	380	490	635	mW	All outputs on. 2 LVPECL (divide = 2), 1 CMOS (divide = 2); at 62.5 MHz out (5 pF load).
	410	525	680	mW	All outputs on. 2 LVPECL, 1 CMOS (divide = 2); At 125 MHz out (5 pF load).
POWER DELTA					
Divider (Divide = 2 to Divide = 1)	15	30	45	mW	For each divider. No clock.
LVPECL Output	65	90	125	mW	For each output. No clock.
LVDS Output	20	50	85	mW	No clock.
CMOS Output (Static)	30	40	50	mW	No clock.
CMOS Output (@ 62.5 MHz)	80	110	140	mW	Single-ended. At 62.5 MHz out with 5 pF load.
CMOS Output (@ 125 MHz)	110	150	190	mW	Single-ended. At 125 MHz out with 5 pF load.
Delay Block	30	45	65	mW	Off to 1.5 ns fs, delay word = 60; output clocking at 62.5 MHz.

¹ This is the rise time of the V_S supply that is required to ensure that a synchronization of the outputs occurs on power-up. The critical factor is the time it takes the V_S to transition the range from 2.2 V to 3.1 V. If the rise time is too slow, the outputs will not be synchronized.

TIMING DIAGRAMS

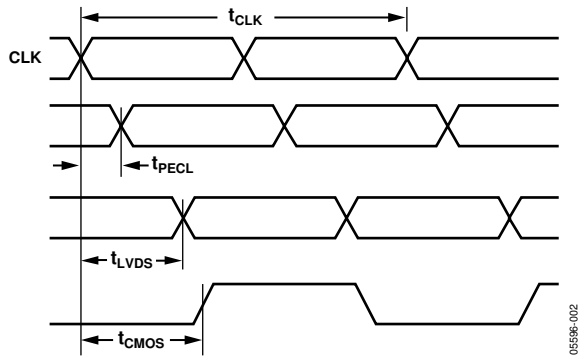

Figure 2. CLK/CLKB to Clock Output Timing, Divide = 1 Mode

05596-002

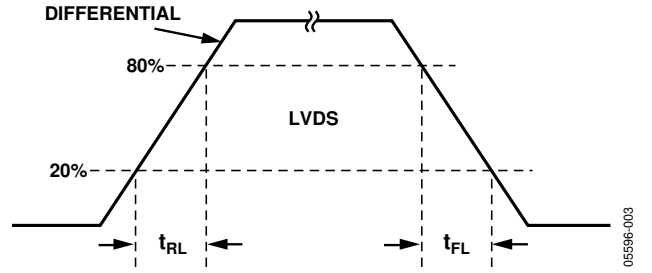

Figure 4. LVDS Timing, Differential

05596-003

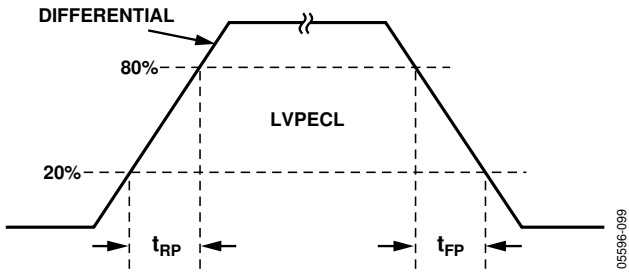

Figure 3. LVPECL Timing, Differential

05596-099

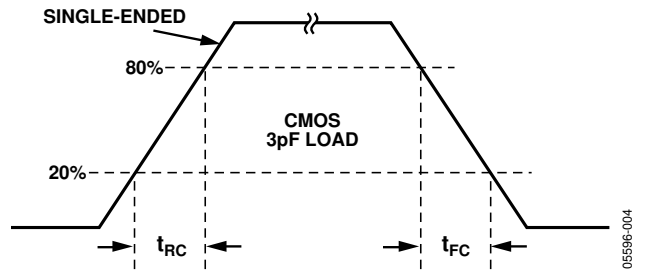

Figure 5. CMOS Timing, Single-Ended, 3 pF Load

05596-004

ABSOLUTE MAXIMUM RATINGS

Table 8.

Parameter or Pin	With Respect to	Min	Max	Unit
VS	GND	-0.3	+3.6	V
RSET	GND	-0.3	$V_S + 0.3$	V
CLK	GND	-0.3	$V_S + 0.3$	V
CLK	CLKB	-1.2	+1.2	V
OUT0, OUT1, OUT2	GND	-0.3	$V_S + 0.3$	V
FUNCTION	GND	-0.3	$V_S + 0.3$	V
STATUS	GND	-0.3	$V_S + 0.3$	V
Junction Temperature ¹			150	°C
Storage Temperature		-65	+150	°C
Lead Temperature (10 sec)			300	°C

Stresses above those listed under Absolute Maximum Ratings may cause permanent damage to the device. This is a stress rating only; functional operation of the device at these or any other conditions above those indicated in the operational section of this specification is not implied. Exposure to absolute maximum ratings for extended periods may affect device reliability.

THERMAL CHARACTERISTICS²

Thermal Resistance

32-Lead LFCSP³
 $\theta_{JA} = 36.6^\circ\text{C/W}$

¹ See Thermal Characteristics for θ_{JA} .

² Thermal impedance measurements were taken on a 4-layer board in still air in accordance with EIA/JESD51-7.

³ The external pad of this package must be soldered to adequate copper land on board.

ESD CAUTION

ESD (electrostatic discharge) sensitive device. Electrostatic charges as high as 4000 V readily accumulate on the human body and test equipment and can discharge without detection. Although this product features proprietary ESD protection circuitry, permanent damage may occur on devices subjected to high energy electrostatic discharges. Therefore, proper ESD precautions are recommended to avoid performance degradation or loss of functionality.



PIN CONFIGURATION AND FUNCTION DESCRIPTIONS

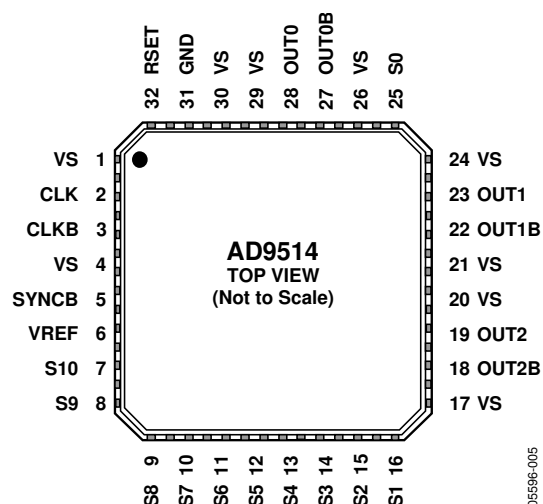

Figure 6. 32-Lead LFCSP Pin Configuration

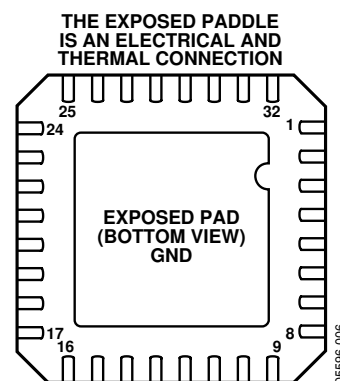

Figure 7. Exposed Paddle

Note that the exposed paddle on this package is an electrical connection as well as a thermal enhancement. For the device to function properly, the paddle *must* be soldered to a PCB land that functions as both a heat dissipation path as well as an electrical ground (analog).

Table 9. Pin Function Descriptions

Pin No.	Mnemonic	Description
1, 4, 17, 20, 21, 24, 26, 29, 30	VS	Power Supply (3.3 V).
2	CLK	Clock Input.
3	CLKB	Complementary Clock Input.
5	SYNCB	Used to Synchronize Outputs; Do Not Let Float.
6	VREF	Provides $2/3 V_S$ for Use as One of the Four Logic Levels on S0 to S10.
7 to 16, 25	S10 to S0	Setup Select Pins. These are 4-state logic. The logic levels are V_S , GND, $1/3 V_S$, and $2/3 V_S$. The VREF pin provides $2/3 V_S$. Each pin is internally biased to $1/3 V_S$ so that a pin requiring that logic level should be left no connection (NC).
18	OUT2B	Complementary LVDS/Inverted CMOS Output.
19	OUT2	LVDS/CMOS Output.
22	OUT1B	Complementary LVPECL Output.
23	OUT1	LVPECL Output.
27	OUT0B	Complementary LVPECL Output.
28	OUT0	LVPECL Output.
31, Exposed Paddle	GND	Ground. The exposed paddle on the back of the chip is also GND.
32	RSET	Current Sets Resistor to Ground. Nominal value = 4.12 k Ω .

TERMINOLOGY

Phase Jitter and Phase Noise

An ideal sine wave can be thought of as having a continuous and even progression of phase with time from 0 to 360 degrees for each cycle. Actual signals, however, display a certain amount of variation from ideal phase progression over time. This phenomenon is called phase jitter. Although there are many causes that can contribute to phase jitter, one major component is due to random noise that is characterized statistically as being Gaussian (normal) in distribution.

This phase jitter leads to a spreading out of the energy of the sine wave in the frequency domain, producing a continuous power spectrum. This power spectrum is usually reported as a series of values whose units are dBc/Hz at a given offset in frequency from the sine wave (carrier). The value is a ratio (expressed in dB) of the power contained within a 1 Hz bandwidth with respect to the power at the carrier frequency. For each measurement, the offset from the carrier frequency is also given.

It is also meaningful to integrate the total power contained within some interval of offset frequencies (for example, 10 kHz to 10 MHz). This is called the integrated phase noise over that frequency offset interval and can be readily related to the time jitter due to the phase noise within that offset frequency interval.

Phase noise has a detrimental effect on the performance of ADCs, DACs, and RF mixers. It lowers the achievable dynamic range of the converters and mixers, although they are affected in somewhat different ways.

Time Jitter

Phase noise is a frequency domain phenomenon. In the time domain, the same effect is exhibited as time jitter. When observing a sine wave, the time of successive zero crossings is seen to vary. For a square wave, the time jitter is seen as a displacement of the edges from their ideal (regular) times of occurrence. In both cases, the variations in timing from the ideal are the time jitter. Since these variations are random in nature, the time jitter is specified in units of seconds root mean square (rms) or 1 sigma of the Gaussian distribution.

Time jitter that occurs on a sampling clock for a DAC or an ADC decreases the SNR and dynamic range of the converter. A sampling clock with the lowest possible jitter provides the highest performance from a given converter.

Additive Phase Noise

It is the amount of phase noise that is attributable to the device or subsystem being measured. The phase noise of any external oscillators or clock sources has been subtracted. This makes it possible to predict the degree to which the device affects the total system phase noise when used in conjunction with the various oscillators and clock sources, each of which contribute their own phase noise to the total. In many cases, the phase noise of one element dominates the system phase noise.

Additive Time Jitter

It is the amount of time jitter that is attributable to the device or subsystem being measured. The time jitter of any external oscillators or clock sources has been subtracted. This makes it possible to predict the degree to which the device will affect the total system time jitter when used in conjunction with the various oscillators and clock sources, each of which contribute their own time jitter to the total. In many cases, the time jitter of the external oscillators and clock sources dominates the system time jitter.

TYPICAL PERFORMANCE CHARACTERISTICS

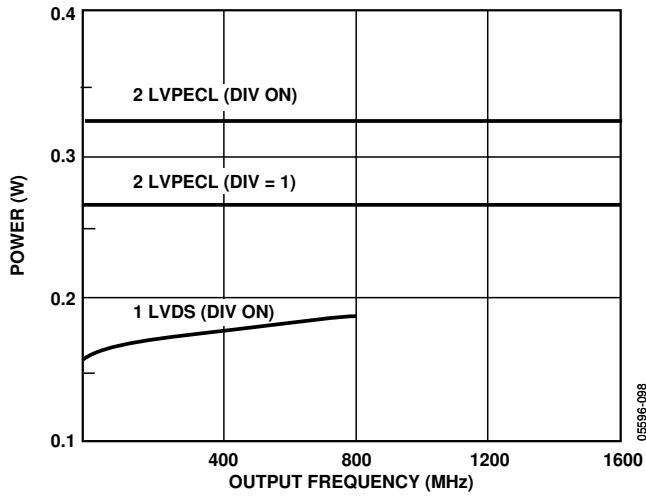

Figure 8. Power vs. Frequency—LVPECL, LVDS

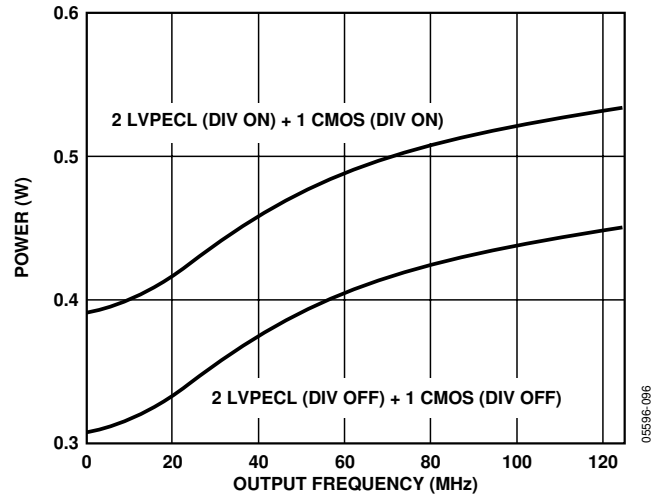
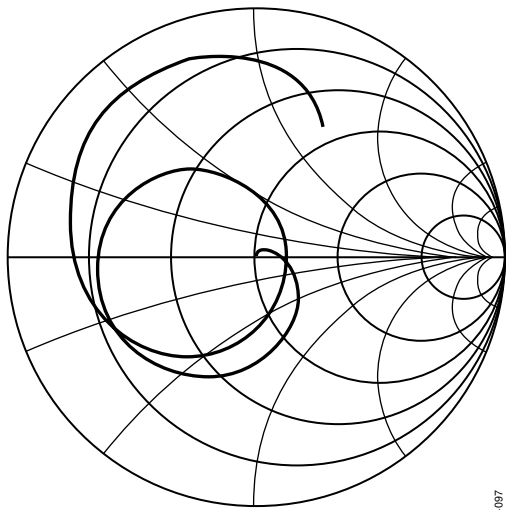

Figure 10. Power vs. Frequency—LVPECL, CMOS



START 300kHz STOP 5GHz
Figure 9. CLK Smith Chart (Evaluation Board)

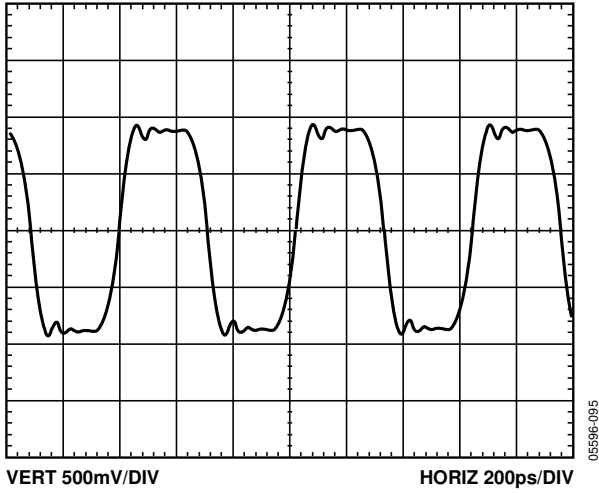

Figure 11. LVPECL Differential Output @ 1600 MHz

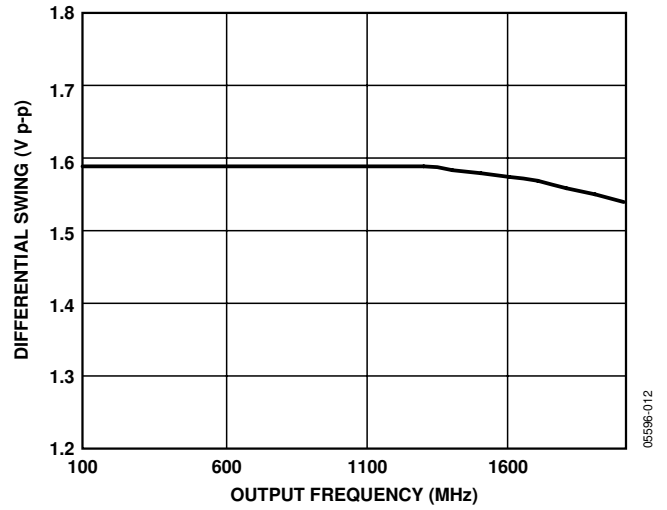

Figure 14. LVPECL Differential Peak-to-Peak Output Swing vs. Frequency

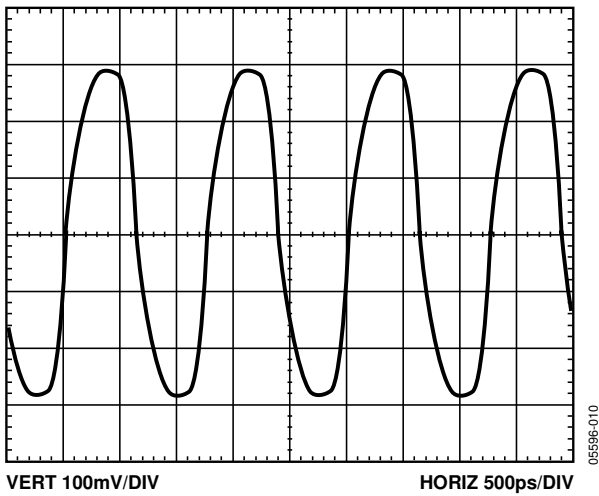

Figure 12. LVDS Differential Output @ 800 MHz

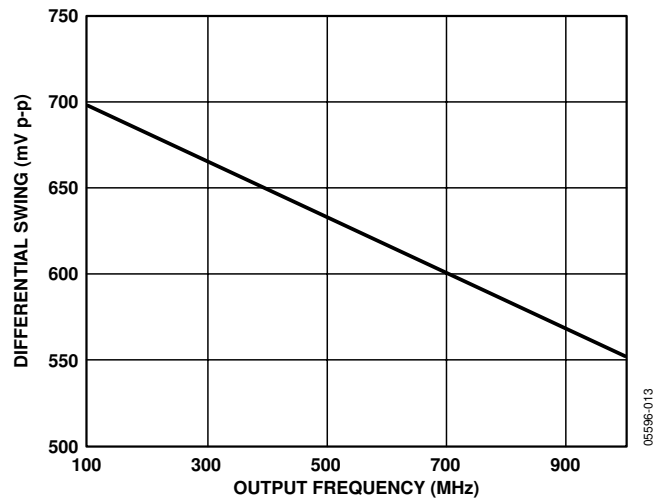

Figure 15. LVDS Differential Peak-to-Peak Output Swing vs. Frequency

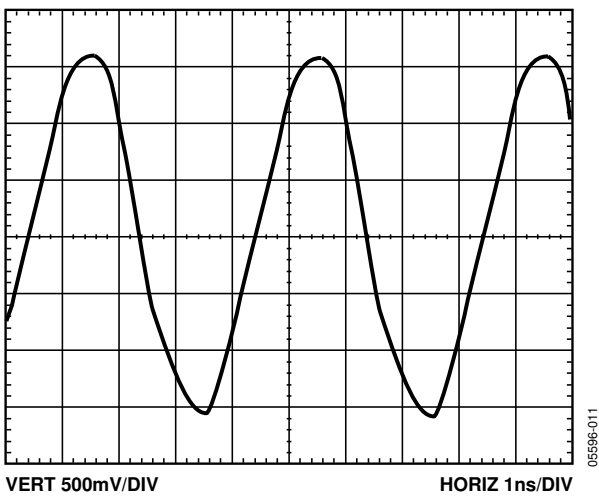

Figure 13. CMOS Single-Ended Output @ 250 MHz with 10 pF Load

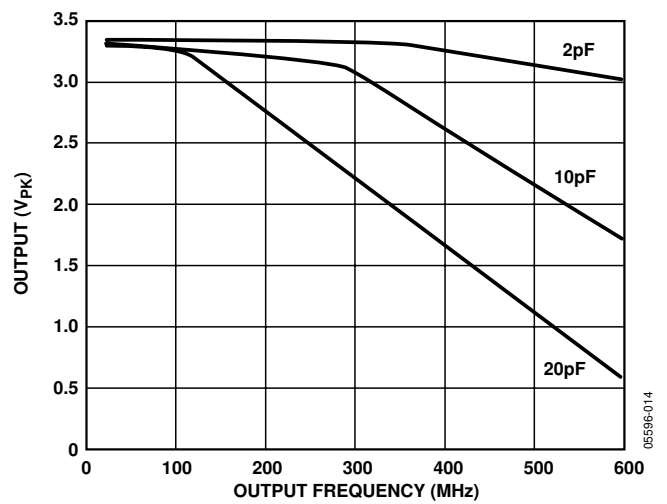

Figure 16. CMOS Single-Ended Output Swing vs. Frequency and Load

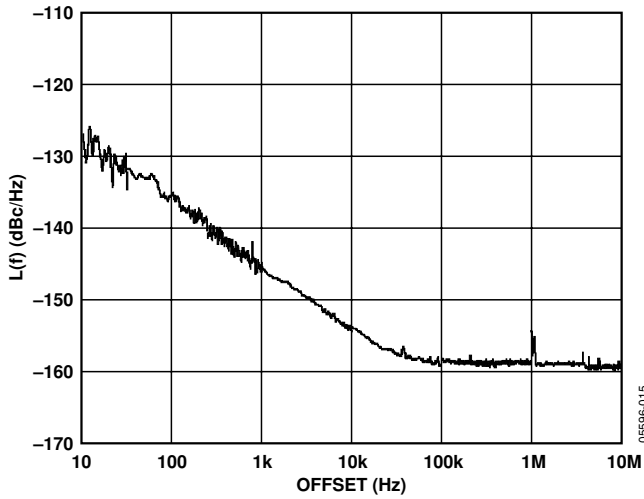

Figure 17. Additive Phase Noise—LVPECL Divide = 1, 245.76 MHz

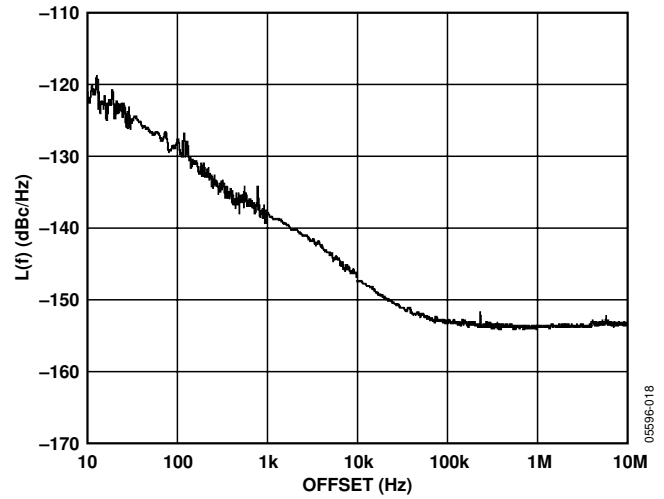

Figure 20. Additive Phase Noise—LVPECL Divide = 1, 622.08 MHz

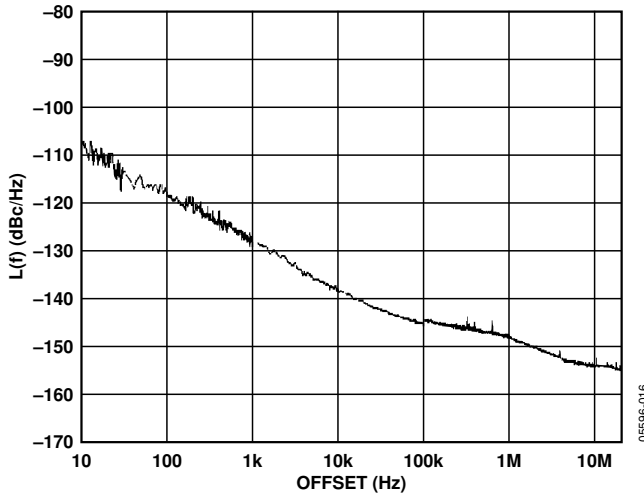

Figure 18. Additive Phase Noise—LVDS Divide = 1, 245.76 MHz

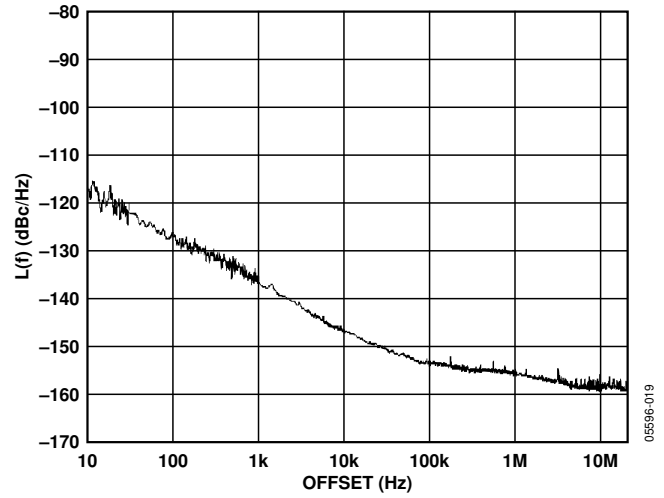

Figure 21. Additive Phase Noise—LVDS Divide = 2, 122.88 MHz

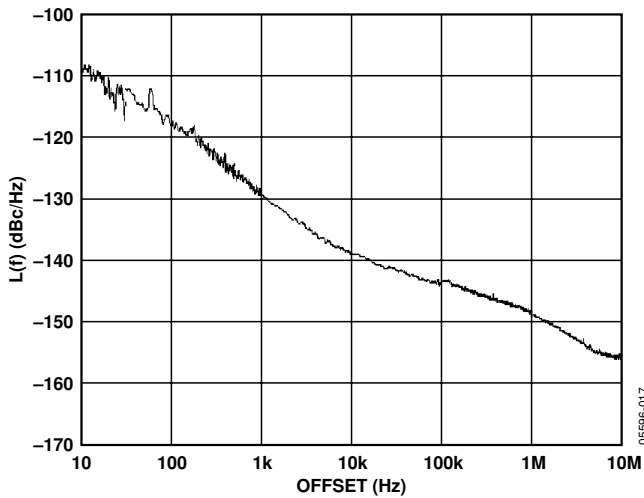

Figure 19. Additive Phase Noise—CMOS Divide = 1, 245.76 MHz

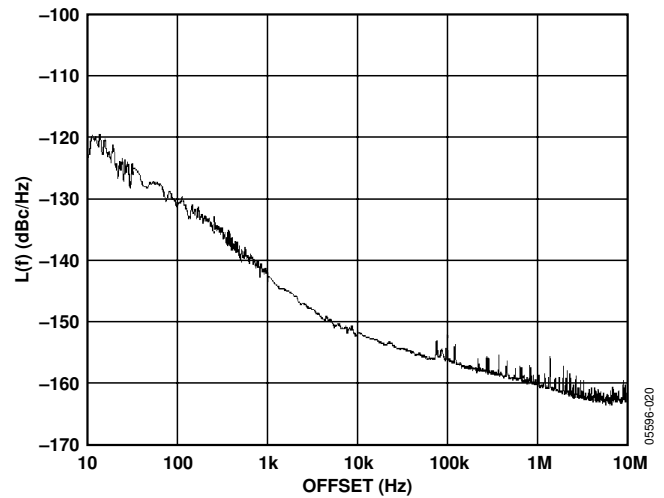

Figure 22. Additive Phase Noise—CMOS Divide = 4, 61.44 MHz

FUNCTIONAL DESCRIPTION

OVERALL

The AD9514 provides for the distribution of its input clock on up to three outputs simultaneously. OUT0 and OUT1 are LVPECL levels. OUT2 can be set to either LVDS or CMOS levels. Each output has its own divider that can be set for a divide ratio selected from a list of integer values from 1 (bypassed) to 32.

OUT2 includes an analog delay block that can be set to add an additional delay of 1.5 ns, 5 ns, or 10 ns full scale, each with 16 levels of fine adjustment.

CLK, CLKB—DIFFERENTIAL CLOCK INPUT

The CLK and CLKB pins are differential clock input pins. This input works up to 1600 MHz. The jitter performance is degraded by a slew rate below 1 V/ns. The input level should be between approximately 150 mV p-p to no more than 2 V p-p. Anything greater can result in turning on the protection diodes on the input pins.

See Figure 23 for the CLK equivalent input circuit. This input is fully differential and self-biased. The signal should be ac-coupled using capacitors. If a single-ended input must be used, this can be accommodated by ac coupling to one side of the differential input only. The other side of the input should be bypassed to a quiet ac ground by a capacitor.

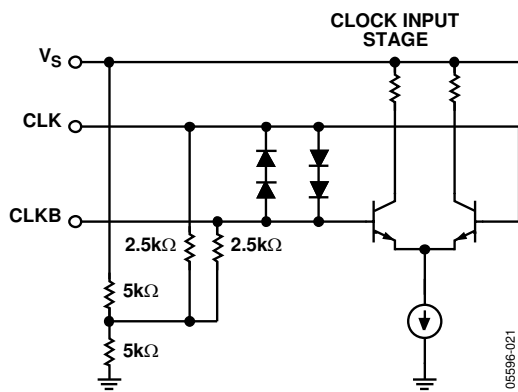

Figure 23 Clock Input Equivalent Circuit

SYNCHRONIZATION

Power-On SYNC

A power-on sync (POS) is issued when the V_S power supply is turned on to ensure that the outputs start in synchronization. The power-on sync works only if the V_S power supply transitions the region from 2.2 V to 3.1 V within 35 ms. The POS can occur up to 65 ms after V_S crosses 2.2 V. Only outputs which are not divide = 1 are synchronized.

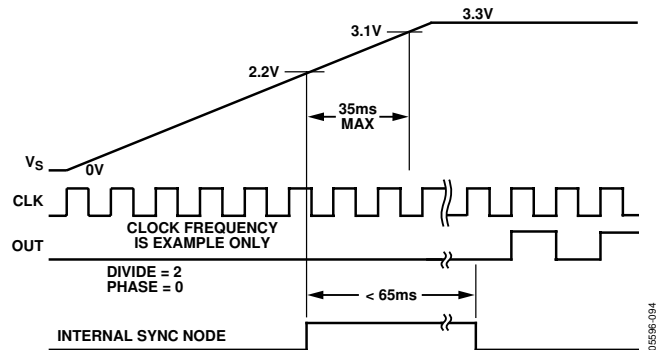

Figure 24. Power-On Sync Timing

SYNCB

If the setup configuration of the AD9514 is changed during operation, the outputs can become unsynchronized. The outputs can be re-synchronized to each other at any time. Synchronization occurs when the SYNCB pin is pulled low and released. The clock outputs (except where divide = 1) are forced into a fixed state (determined by the divide and phase settings) and held there in a static condition until the SYNCB pin is returned to high. Upon release of the SYNCB pin, after four cycles of the clock signal at CLK, all outputs continue clocking in synchronicity (except where divide = 1).

When divide = 1 for an output, that output is not affected by SYNCB.

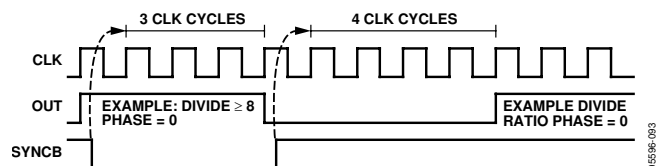

Figure 25. SYNCB Timing with Clock Present

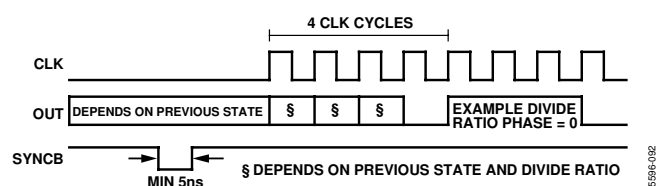

Figure 26. SYNCB Timing with No Clock Present

The outputs of the AD9514 can be synchronized by using the SYNCB pin. Synchronization aligns the phases of the clock outputs, respecting any phase offset that has been set on a particular output's divider.

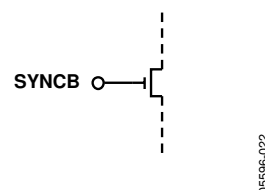

Figure 27. SYNCB Equivalent Input Circuit

Synchronization is initiated by pulling the SYNCB pin low for a minimum of 5 ns. The input clock does not have to be present at the time the command is issued. The synchronization occurs after four input clock cycles.

The synchronization applies to clock outputs:

- that are not turned OFF
- where the divider is not divide = 1 (divider bypassed)

An output with its divider set to divide = 1 (divider bypassed) is always synchronized with the input clock, with a propagation delay.

The SYNCB pin must be pulled up for normal operation. Do not let the SYNCB pin float.

R_{SET} RESISTOR

The internal bias currents of the AD9514 are set by the R_{SET} resistor. This resistor should be as close as possible to the value given as a condition in the Specifications section (R_{SET} = 4.12 kΩ). This is a standard 1% resistor value and should be readily obtainable. The bias currents set by this resistor determine the logic levels and operating conditions of the internal blocks of the AD9514. The performance figures given in the Specifications section assume that this resistor value is used for R_{SET}.

VREF

The VREF pin provides a voltage level of $\frac{2}{3} V_S$. This voltage is one of the four logic levels used by the setup pins (S0 to S10). These pins set the operation of the AD9514. The VREF pin provides sufficient drive capability to drive as many of the setup pins as necessary, up to all on a single part. The VREF pin should be used for no other purpose.

SETUP CONFIGURATION

The specific operation of the AD9514 is set by the logic levels applied to the setup pins (S0 to S10). These pins use four-state logic. The logic levels used are V_S and GND, plus $\frac{1}{3} V_S$ and $\frac{2}{3} V_S$. The $\frac{1}{3} V_S$ level is provided by the internal self-biasing on each of the setup pins (S0 to S10). This is the level seen by a setup pin that is left not connected (NC). The $\frac{2}{3} V_S$ level is provided by the VREF pin. All setup pins requiring the $\frac{2}{3} V_S$ level must be tied to the VREF pin.

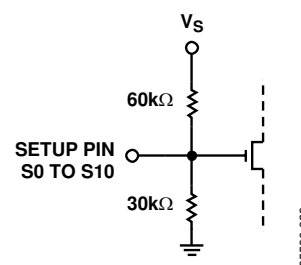

Figure 28. Setup Pin (S0 to S10) Equivalent Circuit

The AD9514 operation is determined by the combination of logic levels present at the setup pins. The setup configurations for the AD9514 are shown in Table 10 to Table 15. The four logic levels are referred to as 0, $\frac{1}{3}$, $\frac{2}{3}$, and 1. These numbers represent the fraction of the V_S voltage that defines the logic levels. See the setup pins thresholds in Table 6.

The meaning of some of the setup pins depends on the logic level set on other pins. For example, the effect of the S3 to S4 pair of pins depends on whether S0 = 0. If S0 = 0, the delay block for OUT2 is off, and the logic levels on S3 to S4 set the phase word of the OUT2 divider. However, if S0 \neq 0, then the full-scale delay for OUT2 is set by the logic level on S0, and S3 to S4 sets the delay block fine adjust (fraction of full scale).

S1 and S2 together determine the logic level of each output or whether a channel is off. An output that is set to OFF is powered down, including the divider.

OUT0 and OUT1 are LVPECL. The LVPECL output differential voltage (V_{OD}) can have three possible levels: 410 mV, 790 mV, and 960 mV (limited to the available combinations, see Table 11). OUT2 can be set to either LVDS or CMOS levels.

S5 and S6 effect depends on S2. If S2 = 0 (OUT2 is off), S5 and S6 set the OUT1 phase word. If S2 \neq 0, S5 and S6 set the OUT2 divide ratio. If S2 = $\frac{2}{3}$, then the value in S9 and S10 overrides the divide ratio for OUT2.

S7 and S8 depend on S2 and S0. If S2 \neq 1, these pins set the OUT1 divide ratio. However, if S2 = 1 (OUT1 is off) and S0 \neq 0, S7 and S8 set the phase word for OUT2.

S9 and S10 depend on S2. If S2 \neq $\frac{2}{3}$, these pins set the OUT0 divide ratio. If S2 = $\frac{2}{3}$, they set the OUT2 divide ratio, overriding S5 and S6.

AD9514

Table 10. S0—OUT2 Delay

S0	Delay Full Scale
0	Off (Bypassed)
1/3	1.5 ns
2/3	5 ns
1	10 ns

Table 11. S1, S2—Output Select

S1	S2	OUT0 LVPECL	OUT1 LVPECL	OUT2 LVDS/CMOS
0	0	OFF	410 mV	OFF
1/3	0	790 mV	790 mV	OFF
2/3	0	410 mV	410 mV	OFF
1	0	960 mV	960 mV	OFF
0	1/3	790 mV	790 mV	CMOS
1/3	1/3	410 mV	410 mV	LVDS
2/3	1/3	410 mV	410 mV	CMOS
1	1/3	790 mV	790 mV	LVDS
0	2/3	OFF	OFF	OFF
1/3	2/3	OFF	OFF	LVDS
2/3	2/3	OFF	OFF	CMOS
1	2/3	OFF	790 mV	OFF
0	1	410 mV	OFF	CMOS
1/3	1	790 mV	OFF	LVDS
2/3	1	410 mV	OFF	LVDS
1	1	790 mV	OFF	CMOS

Table 12. S3, S4—OUT2 Delay Fine Adjust or Phase

S3	S4	S0 ≠ 0	S0 = 0
		OUT2 Delay Fine Adjust (Fraction of FS)	OUT2 Phase
0	0	0	0
1/3	0	1/16	1
2/3	0	1/8	2
1	0	3/16	3
0	1/3	1/4	4
1/3	1/3	5/16	5
2/3	1/3	3/8	6
1	1/3	7/16	7
0	2/3	1/2	8
1/3	2/3	9/16	9
2/3	2/3	5/8	10
1	2/3	11/16	11
0	1	3/4	12
1/3	1	13/16	13
2/3	1	7/8	14
1	1	15/16	15

Table 13. S5, S6—OUT2 Divide or OUT1 Phase

S5	S6	S2 ≠ 0	S2 = 0
		OUT2 Divide (Duty Cycle ¹)	OUT1 Phase
0	0	1	0
1/3	0	2 (50%)	1
2/3	0	3 (33%)	2
1	0	4 (50%)	3
0	1/3	5 (40%)	4
1/3	1/3	6 (50%)	5
2/3	1/3	8 (50%)	6
1	1/3	9 (44%)	7
0	2/3	10 (50%)	8
1/3	2/3	12 (50%)	9
2/3	2/3	15 (47%)	10
1	2/3	16 (50%)	11
0	1	18 (50%)	12
1/3	1	24 (50%)	13
2/3	1	30 (50%)	14
1	1	32 (50%)	15

¹ Duty cycle is the clock signal high time divided by the total period.

Table 15. S9, S10—OUT0 Divide or OUT2 Divide

S9	S10	S2 ≠ 2/3	S2 = 2/3
		OUT0 Divide (Duty Cycle ¹)	OUT2 Divide (Duty Cycle ¹)
0	0	1	7 (43%)
1/3	0	2 (50%)	11 (45%)
2/3	0	3 (33%)	13 (46%)
1	0	4 (50%)	14 (50%)
0	1/3	5 (40%)	17 (47%)
1/3	1/3	6 (50%)	19 (47%)
2/3	1/3	8 (50%)	20 (50%)
1	1/3	9 (44%)	21 (48%)
0	2/3	10 (50%)	22 (50%)
1/3	2/3	12 (50%)	23 (48%)
2/3	2/3	15 (47%)	25 (48%)
1	2/3	16 (50%)	26 (50%)
0	1	18 (50%)	27 (48%)
1/3	1	24 (50%)	28 (50%)
2/3	1	30 (50%)	29 (48%)
1	1	32 (50%)	31 (48%)

¹ Duty cycle is the clock signal high time divided by the total period.

Table 14. S7, S8—OUT1 Divide or OUT2 Phase

S7	S8	S2 ≠ 1	S2 = 1 and S0 ≠ 0
		OUT1 Divide (Duty Cycle ¹)	OUT2 Phase
0	0	1	0
1/3	0	2 (50%)	1
2/3	0	3 (33%)	2
1	0	4 (50%)	3
0	1/3	5 (40%)	4
1/3	1/3	6 (50%)	5
2/3	1/3	8 (50%)	6
1	1/3	9 (44%)	7
0	2/3	10 (50%)	8
1/3	2/3	12 (50%)	9
2/3	2/3	15 (47%)	10
1	2/3	16 (50%)	11
0	1	18 (50%)	12
1/3	1	24 (50%)	13
2/3	1	30 (50%)	14
1	1	32 (50%)	15

¹ Duty cycle is the clock signal high time divided by the total period.

DIVIDER PHASE OFFSET

The phase of OUT1 or OUT2 can be selected, depending on the divide ratio and output configuration chosen. This allows, for example, the relative phase of OUT0 and OUT1 to be set.

After a SYNC operation (see the Synchronization section), the phase offset word of each divider determines the number of input clock (CLK) cycles to wait before initiating a clock output edge. By giving each divider a different phase offset, output-to-output delays can be set in increments of the fast clock period, t_{CLK} .

Figure 29 shows four cases, each with the divider set to divide = 4. By incrementing the phase offset from 0 to 3, the output is offset from the initial edge by a multiple of t_{CLK} .

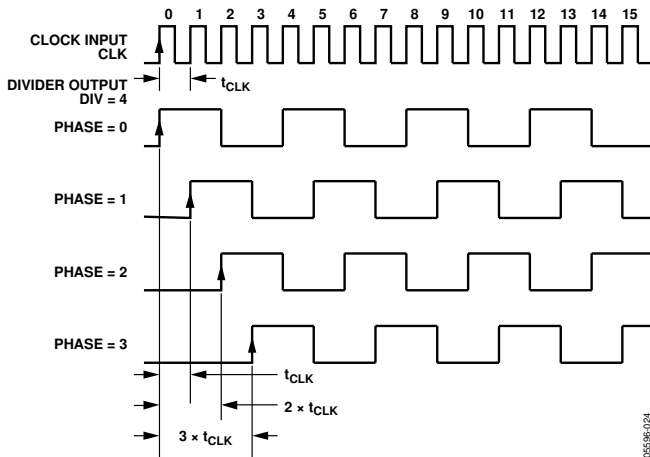

Figure 29. Phase Offset—Divider Set for Divide = 4, Phase Set from 0 to 2

For example:

$$CLK = 491.52 \text{ MHz}$$

$$t_{CLK} = 1/491.52 = 2.0345 \text{ ns}$$

For Divide = 4:

$$\text{Phase Offset } 0 = 0 \text{ ns}$$

$$\text{Phase Offset } 1 = 2.0345 \text{ ns}$$

$$\text{Phase Offset } 2 = 4.069 \text{ ns}$$

$$\text{Phase Offset } 3 = 6.104 \text{ ns}$$

The outputs can also be described as:

$$\text{Phase Offset } 0 = 0^\circ$$

$$\text{Phase Offset } 1 = 90^\circ$$

$$\text{Phase Offset } 2 = 180^\circ$$

$$\text{Phase Offset } 3 = 270^\circ$$

Setting the phase offset to Phase = 4 results in the same relative phase as Phase = 0° or 360°.

The resolution of the phase offset is set by the fast clock period (t_{CLK}) at CLK. The maximum unique phase offset is less than the divide ratio, up to a phase offset of 15.

Phase offsets can be related to degrees by calculating the phase step for a particular divide ratio:

$$\text{Phase Step} = 360^\circ / \text{Divide Ratio}$$

Using some of the same examples:

$$\text{Divide} = 4$$

$$\text{Phase Step} = 360^\circ / 4 = 90^\circ$$

$$\text{Unique Phase Offsets in Degrees Are Phase} = 0^\circ, 90^\circ, 180^\circ, 270^\circ$$

$$\text{Divide} = 9$$

$$\text{Phase Step} = 360^\circ / 9 = 40^\circ$$

$$\text{Unique Phase Offsets in Degrees Are Phase} = 0^\circ, 40^\circ, 80^\circ, 120^\circ, 160^\circ, 200^\circ, 240^\circ, 280^\circ, 320^\circ$$

DELAY BLOCK

OUT2 includes an analog delay element that gives variable time delays (ΔT) in the clock signal passing through that output.

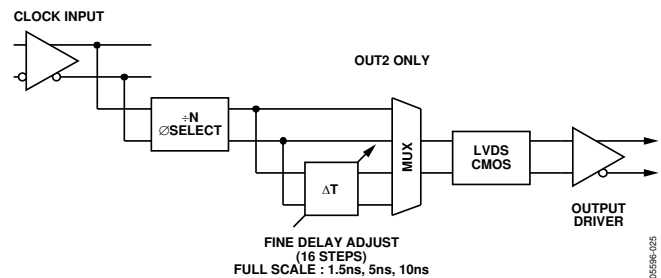

Figure 30. Analog Delay Block

The amount of delay that can be used is determined by the output frequency. The amount of delay is limited to less than one-half cycle of the clock period. For example, for a 10 MHz clock, the delay can extend to the full 10 ns maximum. However, for a 100 MHz clock, the maximum delay is less than 5 ns (or half of the period).

The AD9514 allows for the selection of three full-scale delays, 1.5 ns, 5 ns, and 10 ns, set by delay full scale (see Table 10). Each of these full-scale delays can be scaled by 16 fine adjustment values, which are set by the delay word (see Table 12).

The delay block adds some jitter to the output. This means that the delay function should be used primarily for clocking digital chips, such as FPGA, ASIC, DUC, and DDC, rather than for supplying a sample clock for data converters. The jitter is higher for longer full scales because the delay block uses a ramp and trip points to create the variable delay. A longer ramp means more noise has a chance of being introduced.

When the delay block is OFF (bypassed), it is also powered down.

OUTPUTS

The AD9514 offers three different output level choices: LVPECL, LVDS, and CMOS. OUT0/OUT0B and OUT1/OUT1B are LVPECL differential outputs. There are three amounts of LVPECL differential voltage swing (V_{OD}) that can be selected (410 mV, 790 mV, and 960 mV) within the choices available in Table 11.

OUT2/OUT2B can be selected as either an LVDS differential output or a pair of CMOS single-ended outputs. If selected as CMOS, OUT2 is a noninverted, single-ended output, and OUT2B is an inverted, single-ended output.

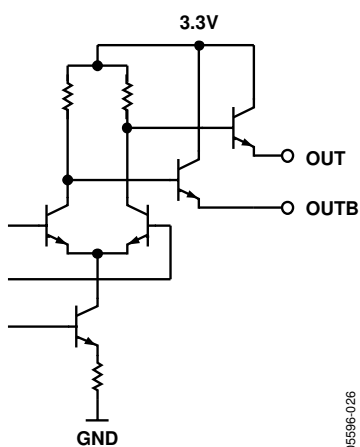

Figure 31. LVPECL Output Simplified Equivalent Circuit

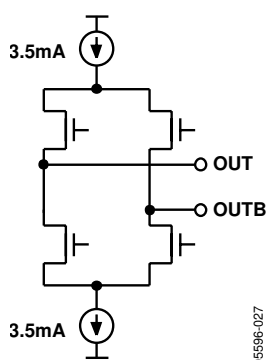

Figure 32. LVDS Output Simplified Equivalent Circuit

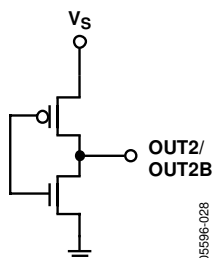

Figure 33. CMOS Equivalent Output Circuit

POWER SUPPLY

The AD9514 requires a $3.3\text{ V} \pm 5\%$ power supply for V_s . The tables in the Specifications section give the performance expected from the AD9514 with the power supply voltage within this range. In no case should the absolute maximum range of -0.3 V to $+3.6\text{ V}$, with respect to GND, be exceeded on Pin V_s .

Good engineering practice should be followed in the layout of power supply traces and the ground plane of the PCB. The power supply should be bypassed on the PCB with adequate capacitance ($>10\ \mu\text{F}$). The AD9514 should be bypassed with adequate capacitors ($0.1\ \mu\text{F}$) at all power pins as close as possible to the part. The layout of the AD9514 evaluation board (AD9514/PCB) is a good example.

Exposed Metal Paddle

The exposed metal paddle on the AD9514 package is an electrical connection, as well as a thermal enhancement. For the device to function properly, the paddle must be properly attached to ground (GND).

The exposed paddle of the AD9514 package must be soldered down. The AD9514 must dissipate heat through its exposed paddle. The PCB acts as a heat sink for the AD9514. The PCB attachment must provide a good thermal path to a larger heat dissipation area, such as a ground plane on the PCB. This requires a grid of vias from the top layer down to the ground plane (see Figure 34). The AD9514 evaluation board (AD9514/PCB) provides a good example of how the part should be attached to the PCB.

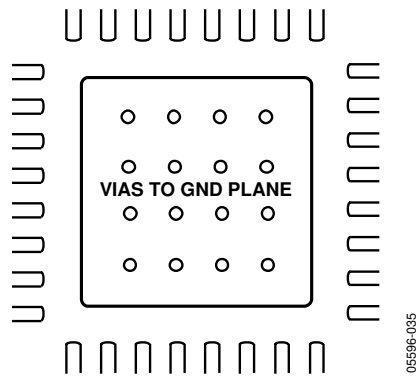

Figure 34. PCB Land for Attaching Exposed Paddle

POWER MANAGEMENT

In some cases the AD9514 can be configured to use less power by turning off functions that are not being used.

The power-saving options include the following:

- Any divider is powered down when set to divide = 1 (bypassed).
- Adjustable delay block on OUT2 is powered down when in off mode (S0 = 0).
- In some cases, an unneeded output can be powered down (see Table 11). This also powers down the divider for that output.