



Chipsmall Limited consists of a professional team with an average of over 10 year of expertise in the distribution of electronic components. Based in Hongkong, we have already established firm and mutual-benefit business relationships with customers from,Europe,America and south Asia,supplying obsolete and hard-to-find components to meet their specific needs.

With the principle of “Quality Parts,Customers Priority,Honest Operation,and Considerate Service”,our business mainly focus on the distribution of electronic components. Line cards we deal with include Microchip,ALPS,ROHM,Xilinx,Pulse,ON,Everlight and Freescale. Main products comprise IC,Modules,Potentiometer,IC Socket,Relay,Connector.Our parts cover such applications as commercial,industrial, and automotives areas.

We are looking forward to setting up business relationship with you and hope to provide you with the best service and solution. Let us make a better world for our industry!



Contact us

Tel: +86-755-8981 8866 Fax: +86-755-8427 6832

Email & Skype: info@chipsmall.com Web: www.chipsmall.com

Address: A1208, Overseas Decoration Building, #122 Zhenhua RD., Futian, Shenzhen, China



FEATURES

- 8-bit dual transmit digital-to-analog converter (DAC)**
- 125 MSPS update rate**
- Excellent SFDR to Nyquist @ 5 MHz output: 66 dBc**
- Excellent gain and offset matching: 0.1%**
- Fully independent or single-resistor gain control**
- Dual port or interleaved data**
- On-chip 1.2 V reference**
- Single 5 V or 3.3 V supply operation**
- Power dissipation: 380 mW @ 5 V**
- Power-down mode: 50 mW @ 5 V**
- 48-lead LQFP**

APPLICATIONS

- Communications**
- Base stations**
- Digital synthesis**
- Quadrature modulation**
- 3D ultrasound**

GENERAL DESCRIPTION

The AD9709¹ is a dual-port, high speed, 2-channel, 8-bit CMOS DAC. It integrates two high quality 8-bit TxDAC+[®] cores, a voltage reference, and digital interface circuitry into a small 48-lead LQFP package. The AD9709 offers exceptional ac and dc performance while supporting update rates of up to 125 MSPS.

The AD9709 has been optimized for processing I and Q data in communications applications. The digital interface consists of two double-buffered latches as well as control logic. Separate write inputs allow data to be written to the two DAC ports independent of one another. Separate clocks control the update rate of the DACs.

A mode control pin allows the AD9709 to interface to two separate data ports, or to a single interleaved high speed data port. In interleaving mode, the input data stream is demuxed into its original I and Q data and then latched. The I and Q data is then converted by the two DACs and updated at half the input data rate.

The GAINCTRL pin allows two modes for setting the full-scale current (I_{OUTFS}) of the two DACs. I_{OUTFS} for each DAC can be set independently using two external resistors, or I_{OUTFS} for both DACs can be set by using a single external resistor. See the Gain Control Mode section for important date code information on this feature.

The DACs utilize a segmented current source architecture combined with a proprietary switching technique to reduce

¹ Patent pending.

Rev. B

Information furnished by Analog Devices is believed to be accurate and reliable. However, no responsibility is assumed by Analog Devices for its use, nor for any infringements of patents or other rights of third parties that may result from its use. Specifications subject to change without notice. No license is granted by implication or otherwise under any patent or patent rights of Analog Devices. Trademarks and registered trademarks are the property of their respective owners.

FUNCTIONAL BLOCK DIAGRAM

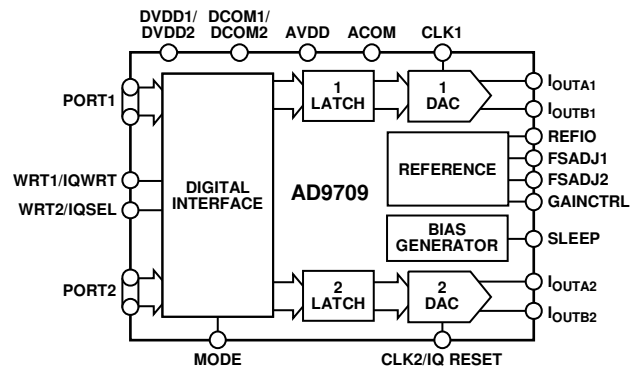

Figure 1.

glitch energy and to maximize dynamic accuracy. Each DAC provides differential current output, thus supporting single-ended or differential applications. Both DACs can be simultaneously updated and provide a nominal full-scale current of 20 mA. The full-scale currents between each DAC are matched to within 0.1%.

The AD9709 is manufactured on an advanced low-cost CMOS process. It operates from a single supply of 3.3 V or 5 V and consumes 380 mW of power.

PRODUCT HIGHLIGHTS

1. The AD9709 is a member of a pin-compatible family of dual TxDACs providing 8-, 10-, 12-, and 14-bit resolution.
2. Dual 8-Bit, 125 MSPS DACs. A pair of high performance DACs optimized for low distortion performance provide for flexible transmission of I and Q information.
3. Matching. Gain matching is typically 0.1% of full scale, and offset error is better than 0.02%.
4. Low Power. Complete CMOS dual DAC function operates at 380 mW from a 3.3 V or 5 V single supply. The DAC full-scale current can be reduced for lower power operation, and a sleep mode is provided for low power idle periods.
5. On-Chip Voltage Reference. The AD9709 includes a 1.20 V temperature-compensated band gap voltage reference.
6. Dual 8-Bit Inputs. The AD9709 features a flexible dual-port interface, allowing dual or interleaved input data.

AD9709* PRODUCT PAGE QUICK LINKS

Last Content Update: 02/23/2017

COMPARABLE PARTS

View a parametric search of comparable parts.

EVALUATION KITS

- AD9709 Evaluation Board

DOCUMENTATION

Application Notes

- AN-237: Choosing DACs for Direct Digital Synthesis
- AN-320A: CMOS Multiplying DACs and Op Amps Combine to Build Programmable Gain Amplifier, Part 1
- AN-555: Using the AD9709, AD9763, AD9765, AD9767 Dual DAC Evaluation Board
- AN-595: Understanding Pin Compatibility in the TxDAC® Line of High Speed D/A Converters
- AN-912: Driving a Center-Tapped Transformer with a Balanced Current-Output DAC

Data Sheet

- AD9709: 8-Bit, 125 MSPS Dual TxDAC+® D/A Converter Data Sheet

TOOLS AND SIMULATIONS

- AD9709 IBIS Models

REFERENCE MATERIALS

Informational

- Advantiv™ Advanced TV Solutions

Solutions Bulletins & Brochures

- Digital to Analog Converters ICs Solutions Bulletin

DESIGN RESOURCES

- AD9709 Material Declaration
- PCN-PDN Information
- Quality And Reliability
- Symbols and Footprints

DISCUSSIONS

View all AD9709 EngineerZone Discussions.

SAMPLE AND BUY

Visit the product page to see pricing options.

TECHNICAL SUPPORT

Submit a technical question or find your regional support number.

DOCUMENT FEEDBACK

Submit feedback for this data sheet.

TABLE OF CONTENTS

Features	1	Analog Outputs	14
Applications.....	1	Digital Inputs	15
Functional Block Diagram	1	DAC Timing.....	15
General Description	1	Sleep Mode Operation	18
Product Highlights	1	Power Dissipation.....	18
Revision History	2	Applying the AD9709	19
Specifications.....	3	Output Configurations	19
DC Specifications	3	Differential Coupling Using a Transformer.....	19
Dynamic Specifications	4	Differential Coupling Using an Op Amp.....	19
Digital Specifications	5	Single-Ended, Unbuffered Voltage Output.....	20
Absolute Maximum Ratings.....	6	Single-Ended, Buffered Voltage Output Configuration.....	20
Thermal Resistance	6	Power and Grounding Considerations.....	20
ESD Caution.....	6	Applications Information	22
Pin Configuration and Function Descriptions.....	7	Quadrature Amplitude Modulation (QAM) Using the AD9709	22
Typical Performance Characteristics	8	CDMA	23
Terminology	11	Evaluation Board	24
Theory of Operation	12	General Description.....	24
Functional Description.....	12	Schematics	24
Reference Operation	13	Evaluation Board Layout.....	30
Gain Control Mode.....	13	Outline Dimensions	32
Setting the Full-Scale Current.....	13	Ordering Guide	32
DAC Transfer Function	14		

REVISION HISTORY

9/09—Rev. A to Rev. B

Changes to Power and Grounding Considerations Section	20
Changes to Schematics Section.....	24
Changes to Evaluation Board Layout Section.....	30

1/08—Rev. 0 to Rev. A

Updated Format.....	Universal
Changed Single Supply Operation to 5 V or 3.3 V	Universal
Changes to Figure 1.....	1
Added Timing Diagram Section	5
Changes to Figure 3 and Table 6.....	7
Change to Figure 12	9
Changes to Figure 18 to Figure 20.....	10
Changes to Functional Description Section	13
Changes to Reference Operation Section.....	13
Changes to Figure 23 and Figure 24.....	13
Changes to Gain Control Mode Section.....	13

Replaced Reference Control Amplifier Section with Setting the Full-Scale Current.....	13
Changes to DAC Transfer Function Section.....	14
Changes to Interleaved Mode Timing Section	16
Added Figure 28	16
Changes to Power and Grounding Considerations Section	20
Changes to Figure 44.....	22
Deleted Figure 43.....	17
Changes to CDMA Section.....	23
Changes to Figure 45 Caption	23
Changes to Figure 46.....	24
Changes to Figure 48.....	26
Updated Outline Dimensions	30
Changes to Ordering Guide	30

5/00—Revision 0: Initial Version

SPECIFICATIONS

DC SPECIFICATIONS

T_{MIN} to T_{MAX} , AVDD = 3.3 V or 5 V, DVDD1 = DVDD2 = 3.3 V or 5 V, I_{OUTFS} = 20 mA, unless otherwise noted.

Table 1.

Parameter	Min	Typ	Max	Unit
RESOLUTION	8			Bits
DC ACCURACY ¹				
Integral Linearity Error (INL)	−0.5	±0.1	+0.5	LSB
Differential Nonlinearity (DNL)	−0.5	±0.1	+0.5	LSB
ANALOG OUTPUT				
Offset Error	−0.02		+0.02	% of FSR
Gain Error Without Internal Reference	−2	±0.25	+2	% of FSR
Gain Error with Internal Reference	−5	+1	+5	% of FSR
Gain Match				
$T_A = 25^{\circ}\text{C}$	−0.3	±0.1	+0.3	% of FSR
T_{MIN} to T_{MAX}	−1.6		+1.6	% of FSR
T_{MIN} to T_{MAX}	−0.14		+0.14	dB
Full-Scale Output Current ²	2.0		20.0	mA
Output Compliance Range	−1.0		+1.25	V
Output Resistance		100		k Ω
Output Capacitance		5		pF
REFERENCE OUTPUT				
Reference Voltage	1.14	1.20	1.26	V
Reference Output Current ³		100		nA
REFERENCE INPUT				
Input Compliance Range	0.1		1.25	V
Reference Input Resistance		1		M Ω
Small-Signal Bandwidth		0.5		MHz
TEMPERATURE COEFFICIENTS				
Offset Drift		0		ppm of FSR/ $^{\circ}\text{C}$
Gain Drift Without Internal Reference		±50		ppm of FSR/ $^{\circ}\text{C}$
Gain Drift with Internal Reference		±100		ppm of FSR/ $^{\circ}\text{C}$
Reference Voltage Drift		±50		ppm/ $^{\circ}\text{C}$
POWER SUPPLY				
Supply Voltages				
AVDD	3	5	5.5	V
DVDD1, DVDD2	2.7	5	5.5	V
Analog Supply Current (I_{AVDD})		71	75	mA
Digital Supply Current (I_{DVDD}) ⁴		5	7	mA
Digital Supply Current (I_{DVDD}) ⁵			15	mA
Supply Current Sleep Mode (I_{AVDD})		8	12	mA
Power Dissipation ⁴ (5 V, I_{OUTFS} = 20 mA)		380	410	mW
Power Dissipation ⁵ (5 V, I_{OUTFS} = 20 mA)		420	450	mW
Power Dissipation ⁶ (5 V, I_{OUTFS} = 20 mA)		450		mW
Power Supply Rejection Ratio ⁷ —AVDD	−0.4		+0.4	% of FSR/V
Power Supply Rejection Ratio ⁷ —DVDD1, DVDD2	−0.025		+0.025	% of FSR/V
OPERATING RANGE	−40		+85	$^{\circ}\text{C}$

¹ Measured at I_{OUTA} , driving a virtual ground.

² Nominal full-scale current, I_{OUTFS} , is 32 times the I_{REF} current.

³ An external buffer amplifier with input bias current <100 nA should be used to drive any external load.

⁴ Measured at $f_{CLK} = 25$ MSPS and $f_{OUT} = 1.0$ MHz.

⁵ Measured at $f_{CLK} = 100$ MSPS and $f_{OUT} = 1$ MHz.

⁶ Measured as unbuffered voltage output with $I_{OUTFS} = 20$ mA and $R_{LOAD} = 50$ Ω at I_{OUTA} and I_{OUTB} , $f_{CLK} = 100$ MSPS, and $f_{OUT} = 40$ MHz.

⁷ $\pm 10\%$ power supply variation.

AD9709

DYNAMIC SPECIFICATIONS

T_{MIN} to T_{MAX} , $AVDD = 3.3\text{ V}$ or 5 V , $DVDD1 = DVDD2 = 3.3\text{ V}$ or 5 V , $I_{OUTFS} = 20\text{ mA}$, differential transformer-coupled output, $50\ \Omega$ doubly terminated, unless otherwise noted.

Table 2.

Parameter	Min	Typ	Max	Unit
DYNAMIC PERFORMANCE				
Maximum Output Update Rate (f_{CLK})	125			MSPS
Output Settling Time (t_{ST}) to 0.1% ¹		35		ns
Output Propagation Delay (t_{PD})		1		ns
Glitch Impulse		5		pV-s
Output Rise Time (10% to 90%) ¹		2.5		ns
Output Fall Time (90% to 10%) ¹		2.5		ns
Output Noise ($I_{OUTFS} = 20\text{ mA}$)		50		pA/ $\sqrt{\text{Hz}}$
Output Noise ($I_{OUTFS} = 2\text{ mA}$)		30		pA/ $\sqrt{\text{Hz}}$
AC LINEARITY				
Spurious-Free Dynamic Range to Nyquist				
$f_{CLK} = 100\text{ MSPS}$, $f_{OUT} = 1.00\text{ MHz}$	63	68		dBc
0 dBFS Output				
-6 dBFS Output				
-12 dBFS Output				
-18 dBFS Output				
$f_{CLK} = 65\text{ MSPS}$, $f_{OUT} = 1.00\text{ MHz}$		68		dBc
$f_{CLK} = 65\text{ MSPS}$, $f_{OUT} = 2.51\text{ MHz}$		68		dBc
$f_{CLK} = 65\text{ MSPS}$, $f_{OUT} = 5.02\text{ MHz}$		66		dBc
$f_{CLK} = 65\text{ MSPS}$, $f_{OUT} = 14.02\text{ MHz}$		60		dBc
$f_{CLK} = 65\text{ MSPS}$, $f_{OUT} = 25\text{ MHz}$		50		dBc
$f_{CLK} = 125\text{ MSPS}$, $f_{OUT} = 25\text{ MHz}$		63		dBc
$f_{CLK} = 125\text{ MSPS}$, $f_{OUT} = 40\text{ MHz}$		55		dBc
Signal to Noise and Distortion Ratio				
$f_{CLK} = 50\text{ MHz}$, $f_{OUT} = 1\text{ MHz}$		50		dB
Total Harmonic Distortion				
$f_{CLK} = 100\text{ MSPS}$, $f_{OUT} = 1.00\text{ MHz}$		-67	-63	dBc
$f_{CLK} = 50\text{ MSPS}$, $f_{OUT} = 2.00\text{ MHz}$		-63		dBc
$f_{CLK} = 125\text{ MSPS}$, $f_{OUT} = 4.00\text{ MHz}$		-63		dBc
$f_{CLK} = 125\text{ MSPS}$, $f_{OUT} = 10.00\text{ MHz}$		-63		dBc
Multitone Power Ratio (Eight Tones at 110 kHz Spacing)				
$f_{CLK} = 65\text{ MSPS}$, $f_{OUT} = 2.00\text{ MHz}$ to 2.99 MHz				
0 dBFS Output		58		dBc
-6 dBFS Output		51		dBc
-12 dBFS Output		46		dBc
-18 dBFS Output		41		dBc
Channel Isolation				
$f_{CLK} = 125\text{ MSPS}$, $f_{OUT} = 10\text{ MHz}$		85		dBc
$f_{CLK} = 125\text{ MSPS}$, $f_{OUT} = 40\text{ MHz}$		77		dBc

¹ Measured single-ended into $50\ \Omega$ load.

DIGITAL SPECIFICATIONS

T_{MIN} to T_{MAX} , $AVDD = 3.3\text{ V}$ or 5 V , $DVDD1 = DVDD2 = 3.3\text{ V}$ or 5 V $I_{OUTFS} = 20\text{ mA}$, unless otherwise noted.

Table 3.

Parameter	Min	Typ	Max	Unit
DIGITAL INPUTS				
Logic 1 Voltage @ $DVDD1 = DVDD2 = 5\text{ V}$	3.5	5		V
Logic 1 Voltage @ $DVDD1 = DVDD2 = 3.3\text{ V}$	2.1	3		V
Logic 0 Voltage @ $DVDD1 = DVDD2 = 5\text{ V}$		0	1.3	V
Logic 0 Voltage @ $DVDD1 = DVDD2 = 3.3\text{ V}$	0		0.9	V
Logic 1 Current	-10		+10	μA
Logic 0 Current	-10		+10	μA
Input Capacitance		5		pF
Input Setup Time (t_s)	2.0			ns
Input Hold Time (t_H)	1.5			ns
Latch Pulse Width (t_{LPW} , t_{CPW})	3.5			ns

Timing Diagram

See Table 3 and the DAC Timing section for more information about the timing specifications.

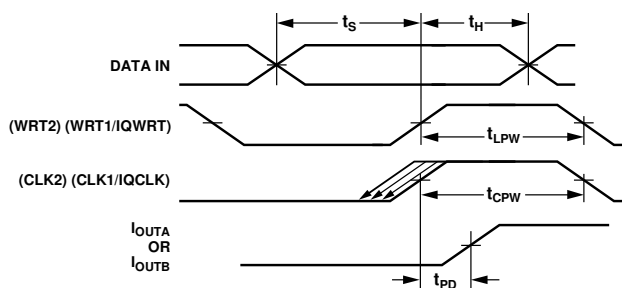

Figure 2. Timing for Dual and Interleaved Modes

ABSOLUTE MAXIMUM RATINGS

Table 4.

Parameter	With Respect To	Rating
AVDD	ACOM	−0.3 V to +6.5 V
DVDD1, DVDD2	DCOM1/DCOM2	−0.3 V to +6.5 V
ACOM	DCOM1/DCOM2	−0.3 V to +0.3 V
AVDD	DVDD1/DVDD2	−6.5 V to +6.5 V
MODE, CLK1/IQCLK, CLK2/IQRESET, WRT1/IQWRT, WRT2/IQSEL	DCOM1/DCOM2	−0.3 V to DVDD1/ DVDD2 + 0.3 V
Digital Inputs	DCOM1/DCOM2	−0.3 V to DVDD1/ DVDD2 + 0.3 V
I _{OUTA1} /I _{OUTA2} , I _{OUTB1} /I _{OUTB2}	ACOM	−1.0 V to AVDD + 0.3 V
REFIO, FSADJ1, FSADJ2	ACOM	−0.3 V to AVDD + 0.3 V
GAINCTRL, SLEEP	ACOM	−0.3 V to AVDD + 0.3 V
Junction Temperature		150°C
Storage Temperature Range		−65°C to +150°C
Lead Temperature (10 sec)		300°C

Stresses above those listed under Absolute Maximum Ratings may cause permanent damage to the device. This is a stress rating only; functional operation of the device at these or any other conditions above those indicated in the operational section of this specification is not implied. Exposure to absolute maximum rating conditions for extended periods may affect device reliability.

THERMAL RESISTANCE

θ_{JA} is specified for the worst-case conditions, that is, a device soldered in a circuit board for surface-mount packages.

Table 5. Thermal Resistance

Package Type	θ_{JA}	Unit
48-Lead LQFP	91	°C/W

ESD CAUTION



ESD (electrostatic discharge) sensitive device. Charged devices and circuit boards can discharge without detection. Although this product features patented or proprietary protection circuitry, damage may occur on devices subjected to high energy ESD. Therefore, proper ESD precautions should be taken to avoid performance degradation or loss of functionality.

PIN CONFIGURATION AND FUNCTION DESCRIPTIONS

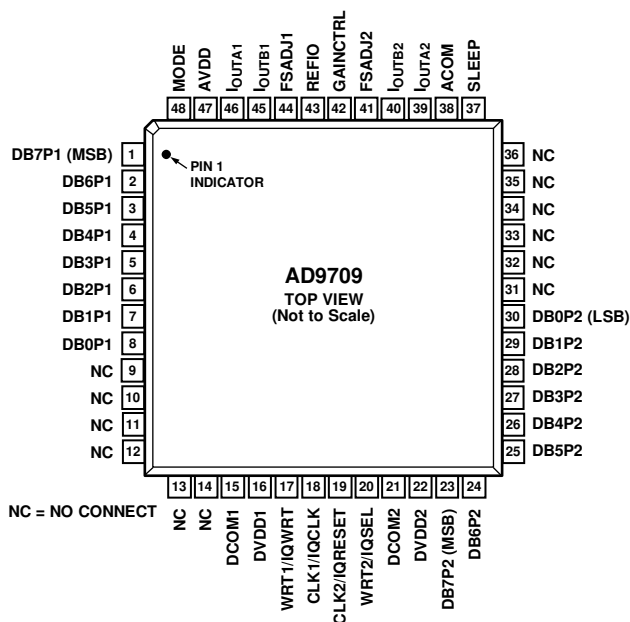

Figure 3. Pin Configuration

Table 6. Pin Function Descriptions

Pin No.	Mnemonic	Description
1 to 8	DB7P1 to DB0P1	Data Bit Pins (Port 1)
9 to 14, 31 to 36	NC	No Connection
15, 21	DCOM1, DCOM2	Digital Common
16, 22	DVDD1, DVDD2	Digital Supply Voltage
17	WRT1/IQWRT	Input Write Signal for Port 1 (IQWRT in Interleaving Mode)
18	CLK1/IQCLK	Clock Input for DAC1 (IQCLK in Interleaving Mode)
19	CLK2/IQRESET	Clock Input for DAC2 (IQRESET in Interleaving Mode)
20	WRT2/IQSEL	Input Write Signal for Port 2 (IQSEL in Interleaving Mode)
23 to 30	DB7P2 to DB0P2	Data Bit Pins (Port 2)
37	SLEEP	Power-Down Control Input
38	ACOM	Analog Common
39, 40	IOUTA2, IOUTB2	Port 2 Differential DAC Current Outputs
41	FSADJ2	Full-Scale Current Output Adjust for DAC2
42	GAINCTRL	Master/Slave Resistor Control Mode.
43	REFIO	Reference Input/Output
44	FSADJ1	Full-Scale Current Output Adjust for DAC1
45, 46	IOUTB1, IOUTA1	Port 1 Differential DAC Current Outputs
47	AVDD	Analog Supply Voltage
48	MODE	Mode Select (1 = dual port, 0 = interleaved)

TYPICAL PERFORMANCE CHARACTERISTICS

AVDD = 3.3 V or 5 V, DVDD = 3.3 V, I_{OUTFS} = 20 mA, 50 Ω doubly terminated load, differential output, T_A = 25°C, SFDR up to Nyquist, unless otherwise noted.

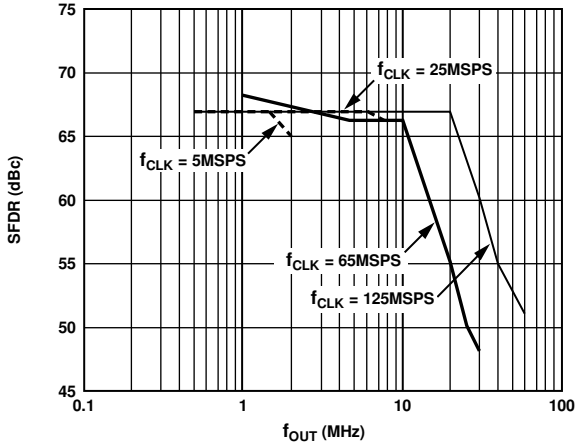

Figure 4. SFDR vs. f_{OUT} @ 0 dBFS

00906-005

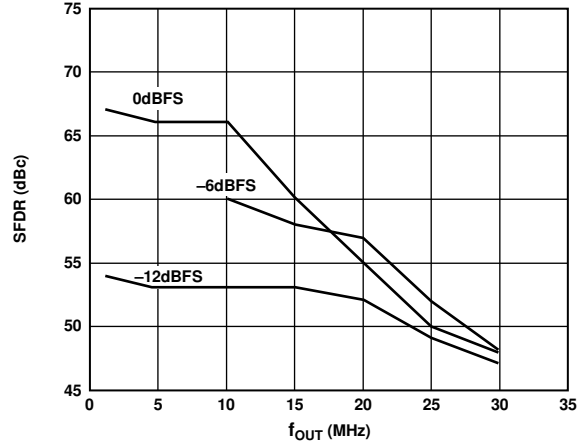

Figure 7. SFDR vs. f_{OUT} @ 65 MSPS

00906-008

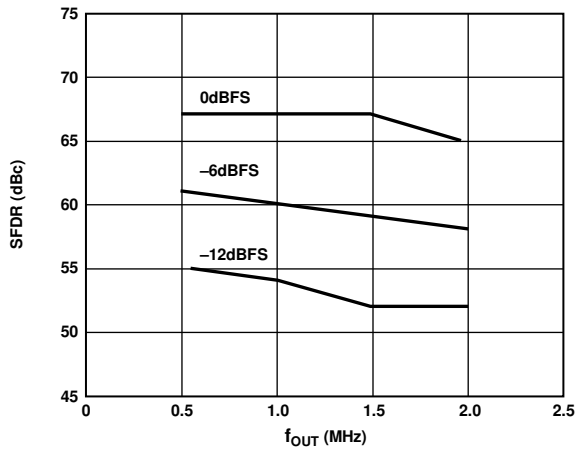

Figure 5. SFDR vs. f_{OUT} @ 5 MSPS

00906-006

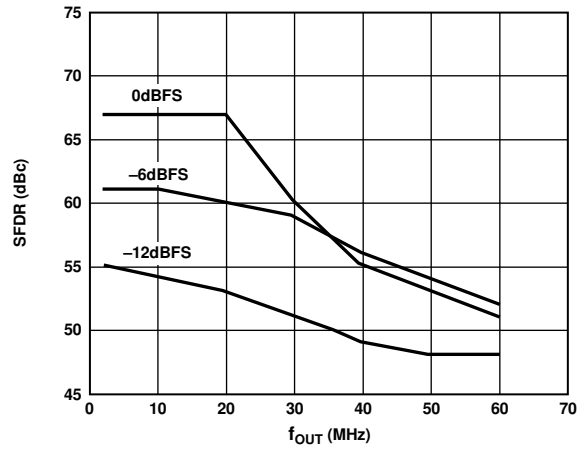

Figure 8. SFDR vs. f_{OUT} @ 125 MSPS

00906-010

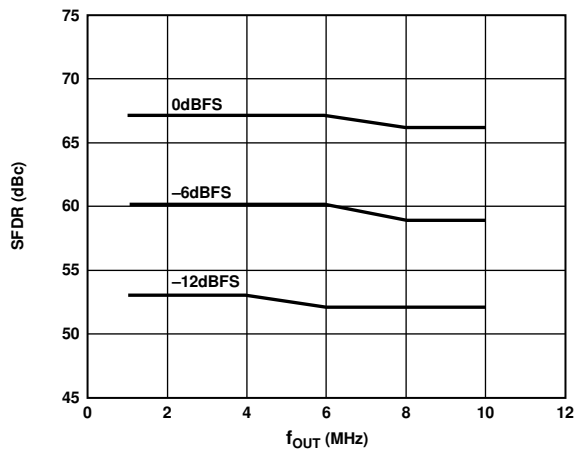

Figure 6. SFDR vs. f_{OUT} @ 25 MSPS

00906-007

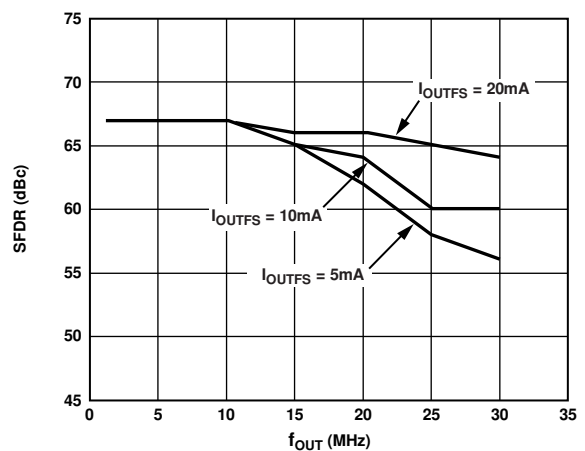

Figure 9. SFDR vs. f_{OUT} and I_{OUTFS} @ 65 MSPS and 0 dBFS

00906-010

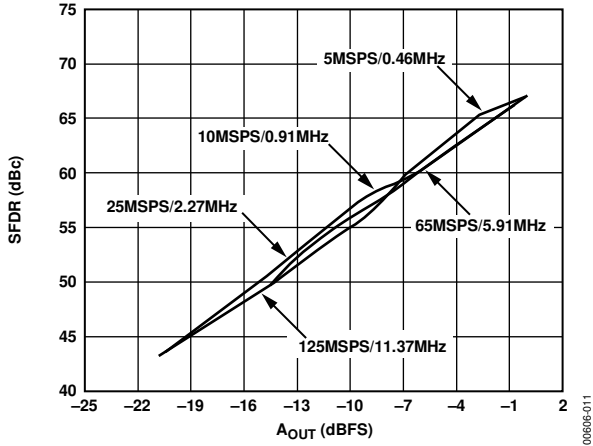

Figure 10. Single-Tone SFDR vs. A_{OUT} @ $f_{OUT} = f_{CLK}/11$

00606-011

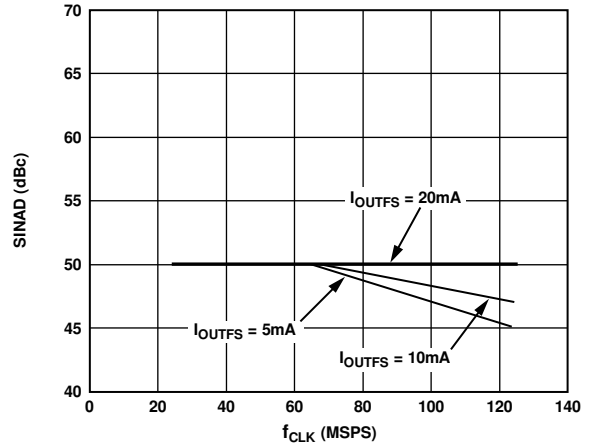

Figure 13. SINAD vs. f_{CLK} and I_{OUTFS} @ $f_{OUT} = 5$ MHz and 0 dBFS

00606-014

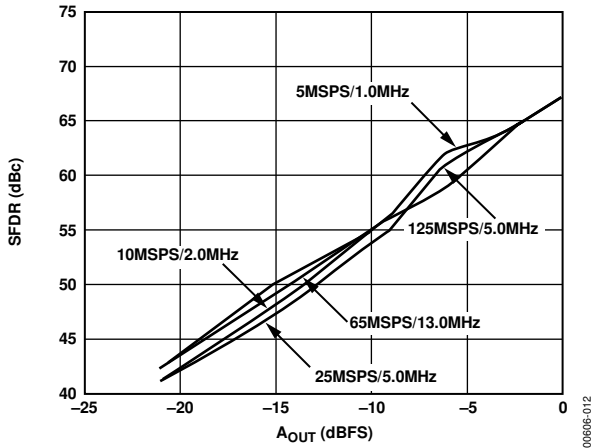

Figure 11. Single-Tone SFDR vs. A_{OUT} @ $f_{OUT} = f_{CLK}/5$

00606-012

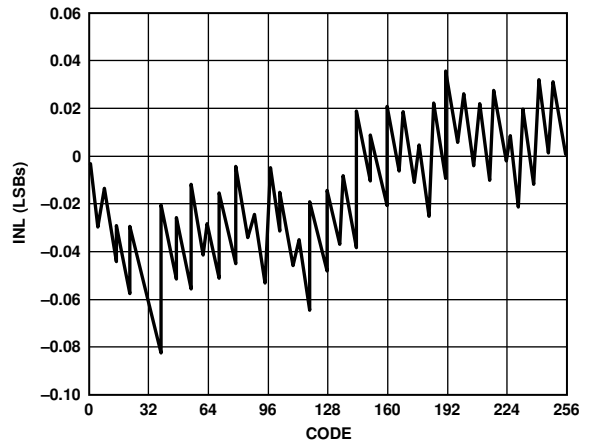

Figure 14. Typical INL

00606-015

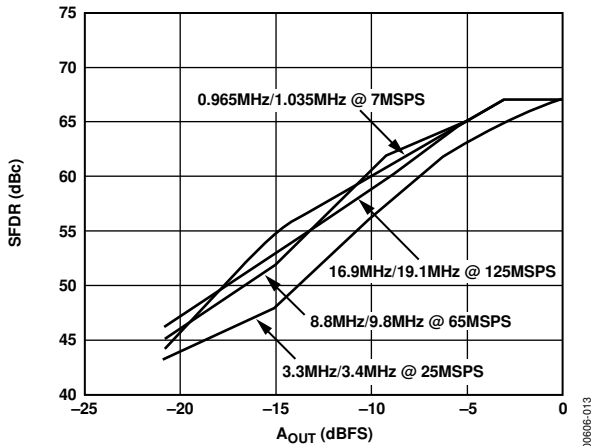

Figure 12. Dual-Tone SFDR vs. A_{OUT} @ $f_{OUT} = f_{CLK}/7$

00606-013

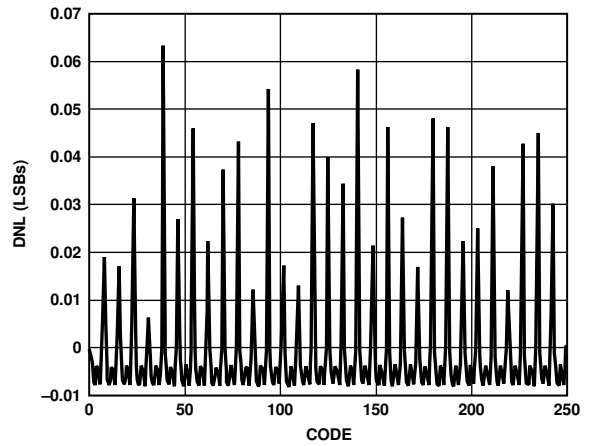

Figure 15. Typical DNL

00606-016

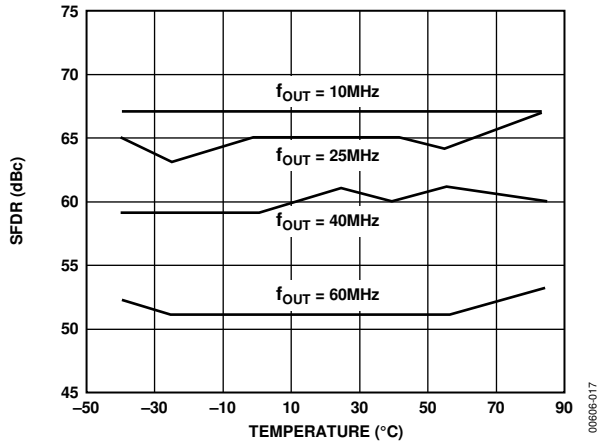

Figure 16. SFDR vs. Temperature @ $f_{CLK} = 125$ MSPS, 0 dBFS

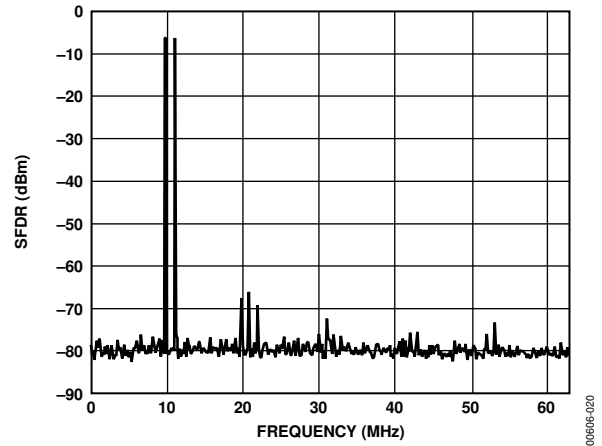

Figure 19. Dual-Tone SFDR @ $f_{CLK} = 125$ MSPS

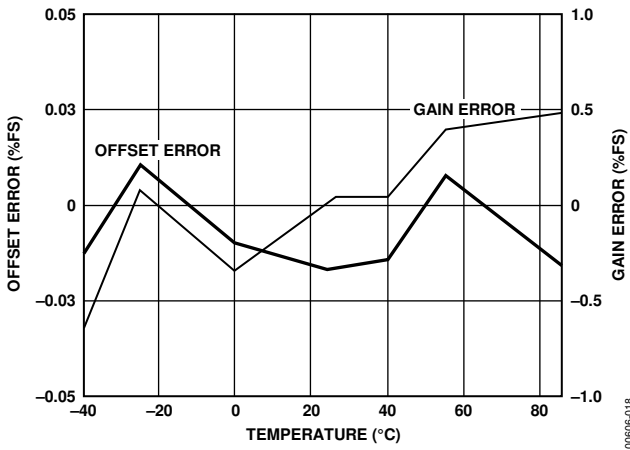

Figure 17. Gain and Offset Error vs. Temperature @ $f_{CLK} = 125$ MSPS

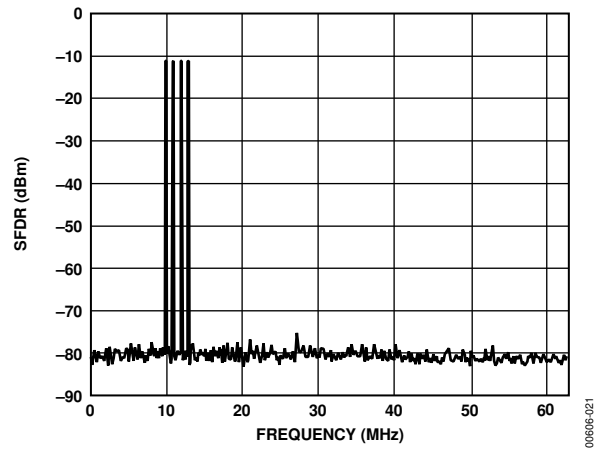

Figure 20. Four-Tone SFDR @ $f_{CLK} = 125$ MSPS

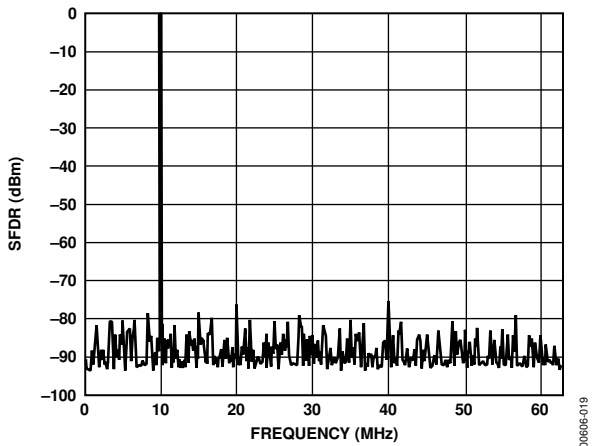

Figure 18. Single-Tone SFDR @ $f_{CLK} = 125$ MSPS

TERMINOLOGY

Linearity Error (Integral Nonlinearity or INL)

Linearity error is defined as the maximum deviation of the actual analog output from the ideal output, determined by a straight line drawn from zero to full-scale.

Differential Nonlinearity (DNL)

DNL is the measure of the variation in analog value, normalized to full scale, associated with a 1 LSB change in digital input code.

Monotonicity

A DAC is monotonic if the output either increases or remains constant as the digital input increases.

Offset Error

Offset error is the deviation of the output current from the ideal of zero. For I_{OUTA} , 0 mA output is expected when the inputs are all 0s. For I_{OUTB} , 0 mA output is expected when all inputs are set to 1s.

Gain Error

Gain error is the difference between the actual and ideal output spans. The actual span is determined by the output when all inputs are set to 1s minus the output when all inputs are set to 0s.

Output Compliance Range

The output compliance range is the range of allowable voltage at the output of a current-output DAC. Operation beyond the maximum compliance limits may cause either output stage saturation or breakdown resulting in nonlinear performance.

Temperature Drift

Temperature drift is specified as the maximum change from the ambient (25°C) value to the value at either T_{MIN} or T_{MAX} . For offset and gain drift, the drift is reported in part per million (ppm) of full-scale range (FSR) per degree Celsius. For reference drift, the drift is reported in ppm per degree Celsius (pm/°C).

Power Supply Rejection (PSR)

PSR is the maximum change in the full-scale output as the supplies are varied from nominal to minimum and maximum specified voltages.

Settling Time

Settling time is the time required for the output to reach and remain within a specified error band about its final value, measured from the start of the output transition.

Glitch Impulse

Asymmetrical switching times in a DAC give rise to undesired output transients that are quantified by a glitch impulse. It is specified as the net area of the glitch in picovolts per second (pV-s).

Spurious-Free Dynamic Range

The difference, in decibels (dB), between the rms amplitude of the output signal and the peak spurious signal over the specified bandwidth.

Total Harmonic Distortion (THD)

THD is the ratio of the rms sum of the first six harmonic components to the rms value of the measured input signal. It is expressed as a percentage or in decibels (dB).

The full-scale output current of each DAC is regulated by separate reference control amplifiers and can be set from 2 mA to 20 mA via an external network connected to the full-scale adjust (FSADJ) pin. The external network in combination with both the reference control amplifier and voltage reference (V_{REFIO}) sets the reference current (I_{REF}), which is replicated to the segmented current sources with the proper scaling factor. The full-scale current (I_{OUTFS}) is $32 \times I_{REF}$.

REFERENCE OPERATION

The AD9709 contains an internal 1.20 V band gap reference. This can easily be overridden by a low noise external reference with no effect on performance. REFIO serves as either an input or output depending on whether the internal or an external reference is used. To use the internal reference, simply decouple the REFIO pin to ACOM with a 0.1 μ F capacitor. The internal reference voltage will be present at REFIO. If the voltage at REFIO is to be used elsewhere in the circuit, an external buffer amplifier with an input bias current of less than 100 nA should be used. An example of the use of the internal reference is shown in Figure 23.

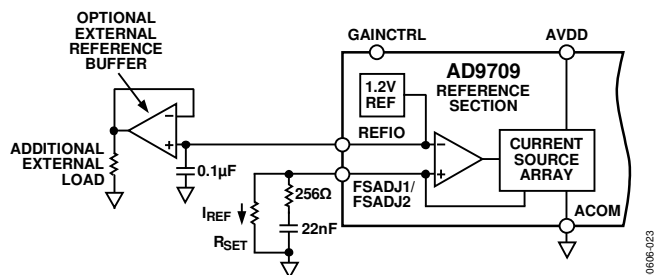

Figure 23. Internal Reference Configuration

An external reference can be applied to REFIO as shown in Figure 24. The external reference can provide either a fixed reference voltage to enhance accuracy and drift performance or a varying reference voltage for gain control. Note that the 0.1 μ F compensation capacitor is not required because the internal reference is overridden and the relatively high input impedance of REFIO minimizes any loading of the external reference.

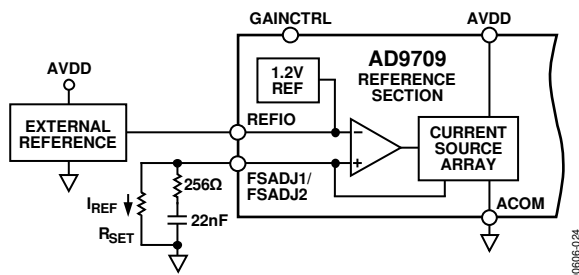

Figure 24. External Reference Configuration

GAIN CONTROL MODE

The AD9709 allows the gain of each channel to be set independently by connecting one R_{SET} resistor to FSADJ1 and another R_{SET} resistor to FSADJ2. To add flexibility and reduce system cost, a single R_{SET} resistor can be used to set the gain of both channels simultaneously.

When GAINCTRL is low (that is, connected to analog ground), the independent channel gain control mode using two resistors is enabled. In this mode, individual R_{SET} resistors should be connected to FSADJ1 and FSADJ2. When GAINCTRL is high (that is, connected to AVDD), the master/slave channel gain control mode using one network is enabled. In this mode, a single network is connected to FSADJ1, and the FSADJ2 pin must be left unconnected.

Note that only parts with a date code of 9930 or later have the master/slave gain control function. For parts with a date code before 9930, Pin 42 must be connected to AGND, and the part operates in the two-resistor, independent gain control mode.

SETTING THE FULL-SCALE CURRENT

Both of the DACs in the AD9709 contain a control amplifier that is used to regulate the full-scale output current (I_{OUTFS}). The control amplifier is configured as a V-I converter, as shown in Figure 23, so that its current output (I_{REF}) is determined by the ratio of the V_{REFIO} and an external resistor, R_{SET} .

$$I_{REF} = \frac{V_{REFIO}}{R_{SET}}$$

The DAC full-scale current, I_{OUTFS} , is an output current 32 times larger than the reference current, I_{REF} .

$$I_{OUTFS} = 32 \times I_{REF}$$

The control amplifier allows a wide (10:1) adjustment span of I_{OUTFS} from 2 mA to 20 mA by setting I_{REF} between 62.5 μ A and 625 μ A. The wide adjustment range of I_{OUTFS} provides several benefits. The first relates directly to the power dissipation of the AD9709, which is proportional to I_{OUTFS} (refer to the Power Dissipation section). The second relates to the 20 dB adjustment, which is useful for system gain control purposes.

It should be noted that when the R_{SET} resistors are 2 k Ω or less, the 22 nF capacitor and 256 Ω resistor shown in Figure 23 and Figure 24 are not required and the reference current can be set by the R_{SET} resistors alone. For R_{SET} values greater than 2 k Ω , the 22 nF capacitor and 256 Ω resistor networks are required to ensure the stability of the reference control amplifier(s). Regardless of the value of R_{SET} , however, if the R_{SET} resistor is located more than ~10 cm away from the pin, use of the 22 nF capacitor and 256 Ω resistor is recommended.

DAC TRANSFER FUNCTION

Both DACs in the AD9709 provide complementary current outputs, I_{OUTA} and I_{OUTB} . I_{OUTA} provides a near full-scale current output, I_{OUTFS} , when all bits are high (that is, $DAC\ CODE = 256$) while I_{OUTB} , the complementary output, provides no current.

The current output appearing at I_{OUTA} and I_{OUTB} is a function of both the input code and I_{OUTFS} and can be expressed as

$$I_{OUTA} = (DAC\ CODE/256) \times I_{OUTFS} \quad (1)$$

$$I_{OUTB} = (255 - DAC\ CODE)/256 \times I_{OUTFS} \quad (2)$$

where $DAC\ CODE = 0$ to 255 (that is, decimal representation).

I_{OUTFS} is a function of the reference current (I_{REF}), which is nominally set by a reference voltage (V_{REFIO}) and an external resistor (R_{SET}). It can be expressed as

$$I_{OUTFS} = 32 \times I_{REF} \quad (3)$$

where

$$I_{REF} = V_{REFIO}/R_{SET} \quad (4)$$

The two current outputs typically drive a resistive load directly or via a transformer. If dc coupling is required, I_{OUTA} and I_{OUTB} should be connected directly to matching resistive loads, R_{LOAD} , that are tied to the analog common, ACOM. Note that R_{LOAD} can represent the equivalent load resistance seen by I_{OUTA} or I_{OUTB} , as would be the case in a doubly terminated 50 Ω or 75 Ω cable. The single-ended voltage output appearing at the I_{OUTA} and I_{OUTB} nodes is

$$V_{OUTA} = I_{OUTA} \times R_{LOAD} \quad (5)$$

$$V_{OUTB} = I_{OUTB} \times R_{LOAD} \quad (6)$$

Note the full-scale value of V_{OUTA} and V_{OUTB} must not exceed the specified output compliance range to maintain the specified distortion and linearity performance.

$$V_{DIFF} = (I_{OUTA} - I_{OUTB}) \times R_{LOAD} \quad (7)$$

Equation 7 highlights some of the advantages of operating the AD9709 differentially. First, the differential operation helps cancel common-mode error sources associated with I_{OUTA} and I_{OUTB} , such as noise, distortion, and dc offsets. Second, the differential code-dependent current and subsequent voltage, V_{DIFF} , is twice the value of the single-ended voltage output (that is, V_{OUTA} or V_{OUTB}), thus providing twice the signal power to the load.

Note that the gain drift temperature performance for a single-ended (V_{OUTA} and V_{OUTB}) or differential output (V_{DIFF}) of the AD9709 can be enhanced by selecting temperature tracking resistors for R_{LOAD} and R_{SET} due to their ratiometric relationship.

ANALOG OUTPUTS

The complementary current outputs, I_{OUTA} and I_{OUTB} , in each DAC can be configured for single-ended or differential operation. I_{OUTA} and I_{OUTB} can be converted into complementary single-ended voltage outputs, V_{OUTA} and V_{OUTB} , via a load resistor, R_{LOAD} , as described in Equation 5 through Equation 7. The differential voltage, V_{DIFF} , existing between V_{OUTA} and V_{OUTB} can be converted to a single-ended voltage via a transformer or

differential amplifier configuration. The ac performance of the AD9709 is optimum and specified using a differential transformer-coupled output in which the voltage swing at I_{OUTA} and I_{OUTB} is limited to ± 0.5 V. If a single-ended unipolar output is desirable, I_{OUTA} should be selected.

The distortion and noise performance of the AD9709 can be enhanced when it is configured for differential operation. The common-mode error sources of both I_{OUTA} and I_{OUTB} can be significantly reduced by the common-mode rejection of a transformer or differential amplifier. These common-mode error sources include even-order distortion products and noise. The enhancement in distortion performance becomes more significant as the frequency content of the reconstructed waveform increases. This is due to the first-order cancellation of various dynamic common-mode distortion mechanisms, digital feedthrough, and noise.

Performing a differential-to-single-ended conversion via a transformer also provides the ability to deliver twice the reconstructed signal power to the load (that is, assuming no source termination). Because the output currents of I_{OUTA} and I_{OUTB} are complementary, they become additive when processed differentially. A properly selected transformer allows the AD9709 to provide the required power and voltage levels to different loads.

The output impedance of I_{OUTA} and I_{OUTB} is determined by the equivalent parallel combination of the PMOS switches associated with the current sources and is typically 100 k Ω in parallel with 5 pF. It is also slightly dependent on the output voltage (that is, V_{OUTA} and V_{OUTB}) due to the nature of a PMOS device. As a result, maintaining I_{OUTA} and/or I_{OUTB} at a virtual ground via an I-V op amp configuration results in the optimum dc linearity. Note that the INL/DNL specifications for the AD9709 are measured with I_{OUTA} maintained at a virtual ground via an op amp.

I_{OUTA} and I_{OUTB} also have a negative and positive voltage compliance range that must be adhered to in order to achieve optimum performance. The negative output compliance range of -1.0 V is set by the breakdown limits of the CMOS process. Operation beyond this maximum limit may result in a breakdown of the output stage and affect the reliability of the AD9709.

The positive output compliance range is slightly dependent on the full-scale output current, I_{OUTFS} . When I_{OUTFS} is decreased from 20 mA to 2 mA, the positive output compliance range degrades slightly from its nominal 1.25 V to 1.00 V. The optimum distortion performance for a single-ended or differential output is achieved when the maximum full-scale signal at I_{OUTA} and I_{OUTB} does not exceed 0.5 V. Applications requiring the AD9709 output (that is, V_{OUTA} and/or V_{OUTB}) to extend its output compliance range should size R_{LOAD} accordingly. Operation beyond this compliance range adversely affects the linearity performance of the AD9709 and subsequently degrade its distortion performance.

DIGITAL INPUTS

The digital inputs of the AD9709 consist of two independent channels. For the dual port mode, each DAC has its own dedicated 8-bit data port: WRT line and CLK line. In the interleaved timing mode, the function of the digital control pins changes as described in the Interleaved Mode Timing section. The 8-bit parallel data inputs follow straight binary coding where DB7P1 and DB7P2 are the most significant bits (MSBs) and DB0P1 and DB0P2 are the least significant bits (LSBs). I_{OUTA} produces a full-scale output current when all data bits are at Logic 1. I_{OUTB} produces a complementary output with the full-scale current split between the two outputs as a function of the input code.

The digital interface is implemented using an edge-triggered master slave latch. The DAC outputs are updated following either the rising edge or every other rising edge of the clock, depending on whether dual or interleaved mode is used. The DAC outputs are designed to support a clock rate as high as 125 MSPS. The clock can be operated at any duty cycle that meets the specified latch pulse width. The setup and hold times can also be varied within the clock cycle as long as the specified minimum times are met, although the location of these transition edges may affect digital feedthrough and distortion performance. Best performance is typically achieved when the input data transitions on the falling edge of a 50% duty cycle clock.

DAC TIMING

The AD9709 can operate in two timing modes, dual and interleaved, which are described in the following sections. The block diagram in Figure 25 represents the latch architecture in the interleaved timing mode.

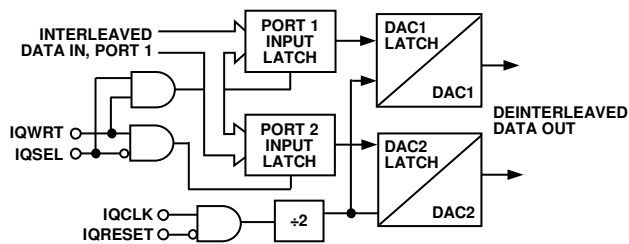

Figure 25. Latch Structure in Interleaved Mode

Dual Port Mode Timing

When the MODE pin is at Logic 1, the AD9709 operates in dual port mode (refer to Figure 21). The AD9709 functions as two distinct DACs. Each DAC has its own completely independent digital input and control lines.

The AD9709 features a double-buffered data path. Data enters the device through the channel input latches. This data is then transferred to the DAC latch in each signal path. After the data is loaded into the DAC latch, the analog output settles to its new value.

For general consideration, the WRT lines control the channel input latches, and the CLK lines control the DAC latches. Both sets of latches are updated on the rising edge of their respective control signals.

The rising edge of CLK should occur before or simultaneously with the rising edge of WRT. If the rising edge of CLK occurs after the rising edge of WRT, a minimum delay of 2 ns should be maintained from rising edge of WRT to rising edge of CLK.

Timing specifications for dual port mode are given in Figure 26 and Figure 27.

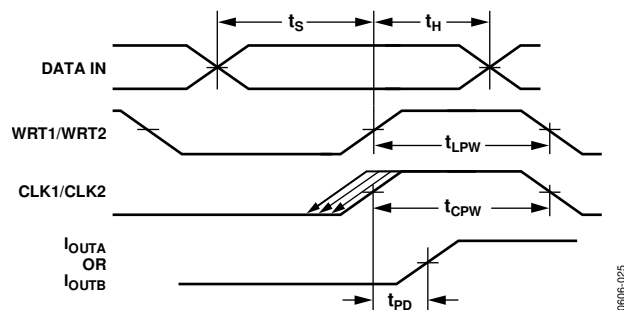

Figure 26. Dual Port Mode Timing

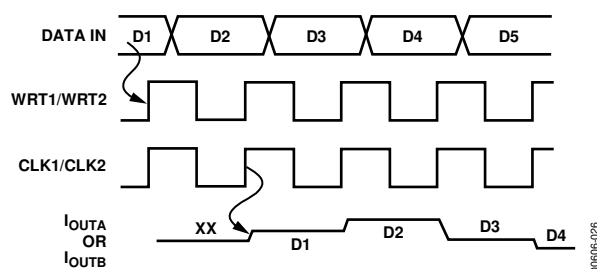

Figure 27. Dual Mode Timing

Interleaved Mode Timing

When the MODE pin is at Logic 0, the AD9709 operates in interleaved mode (refer to Figure 25). In addition, WRT1 functions as IQWRT, CLK1 functions as IQCLK, WRT2 functions as IQSEL, and CLK2 functions as IQRESET.

Data enters the device on the rising edge of IQWRT. The logic level of IQSEL steers the data to either Channel Latch 1 (IQSEL = 1) or to Channel Latch 2 (IQSEL = 0). For proper operation, IQSEL should only change state when IQWRT and IQCLK are low.

When IQRESET is high, IQCLK is disabled. When IQRESET goes low, the next rising edge on IQCLK updates both DAC latches with the data present at their inputs. In the interleaved mode, IQCLK is divided by 2 internally. Following this first rising edge, the DAC latches are only updated on every other rising edge of IQCLK. In this way, IQRESET can be used to synchronize the routing of the data to the DACs.

Similar to the order of CLK and WRT in dual port mode, IQCLK should occur before or simultaneously with IQWRT.

AD9709

Timing specifications for interleaved mode are shown in Figure 28 and Figure 30.

The digital inputs are CMOS compatible with logic thresholds, $V_{THRESHOLD}$, set to approximately half the digital positive supply (DVDDx) or

$$V_{THRESHOLD} = DVDDx/2 (\pm 20\%)$$

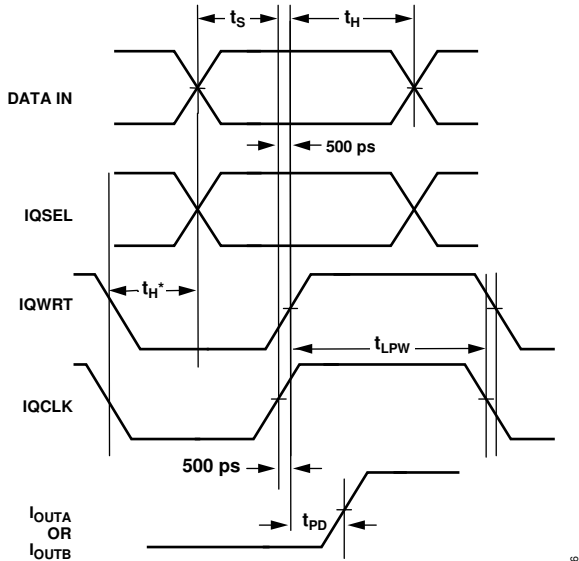

*APPLIES TO FALLING EDGE OF IQCLK/IQWRT AND IQSEL ONLY.

Figure 28. 5 V or 3.3 V Interleaved Mode Timing

At 5 V it is permissible to drive IQWRT and IQCLK together as shown in Figure 29, but at 3.3 V the interleaved data transfer is not reliable.

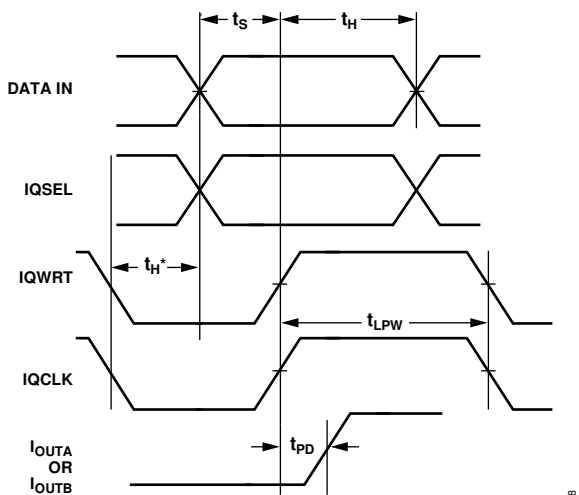

*APPLIES TO FALLING EDGE OF IQCLK/IQWRT AND IQSEL ONLY.

Figure 29. 5 V Only Interleaved Mode Timing

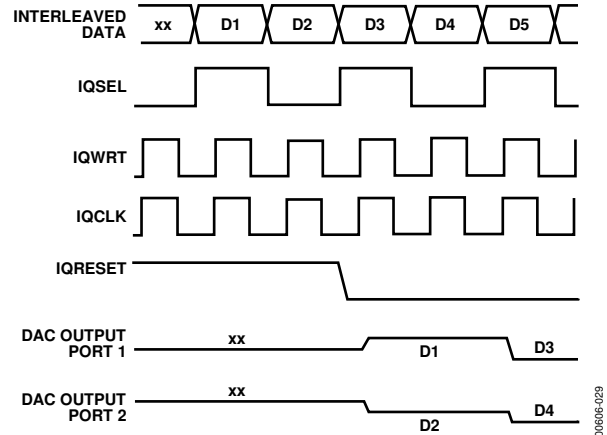

Figure 30. Interleaved Mode Timing

The internal digital circuitry of the AD9709 is capable of operating at a digital supply of 3.3 V or 5 V. As a result, the digital inputs can also accommodate TTL levels when DVDD1/DVDD2 is set to accommodate the maximum high level voltage ($V_{OH(MAX)}$) of the TTL drivers. A DVDD1/DVDD2 of 3.3 V typically ensures proper compatibility with most TTL logic families. Figure 31 shows the equivalent digital input circuit for the data and clock inputs. The sleep mode input is similar with the exception that it contains an active pull-down circuit, thus ensuring that the AD9709 remains enabled if this input is left disconnected.

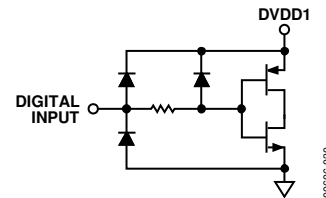

Figure 31. Equivalent Digital Input

Because the AD9709 is capable of being clocked up to 125 MSPS, the quality of the clock and data input signals are important in achieving the optimum performance. Operating the AD9709 with reduced logic swings and a corresponding digital supply (DVDD1/DVDD2) results in the lowest data feedthrough and on-chip digital noise. The drivers of the digital data interface circuitry should be specified to meet the minimum setup and hold times of the AD9709 as well as its required minimum and maximum input logic level thresholds.

Digital signal paths should be kept short, and run lengths should be matched to avoid propagation delay mismatch. The insertion of a low value (that is, 20 Ω to 100 Ω) resistor network between the AD9709 digital inputs and driver outputs may be helpful in reducing any overshooting and ringing at the digital inputs that contribute to digital feedthrough. For longer board traces and high data update rates, stripline techniques with proper impedance and termination resistors should be considered to maintain “clean” digital inputs.

The external clock driver circuitry provides the AD9709 with a low-jitter clock input meeting the minimum and maximum logic levels while providing fast edges. Fast clock edges help minimize jitter manifesting itself as phase noise on a reconstructed waveform. Therefore, the clock input should be driven by the fastest logic family suitable for the application.

Note that the clock input can also be driven via a sine wave, which is centered around the digital threshold (that is, $DVDDx/2$) and meets the minimum and maximum logic threshold. This typically results in a slight degradation in the phase noise, which becomes more noticeable at higher sampling rates and output frequencies. In addition, at higher sampling rates, the 20% tolerance of the digital logic threshold should be considered because it affects the effective clock duty cycle and, subsequently, cut into the required data setup and hold times.

Input Clock and Data Timing Relationship

SNR in a DAC is dependent on the relationship between the position of the clock edges and the point in time at which the input data changes. The AD9709 is rising-edge triggered and therefore exhibits SNR sensitivity when the data transition is close to this edge. In general, the goal when applying the AD9709 is to make the data transition close to the falling clock edge. This becomes more important as the sample rate increases. Figure 32 shows the relationship of SNR to clock/data placement.

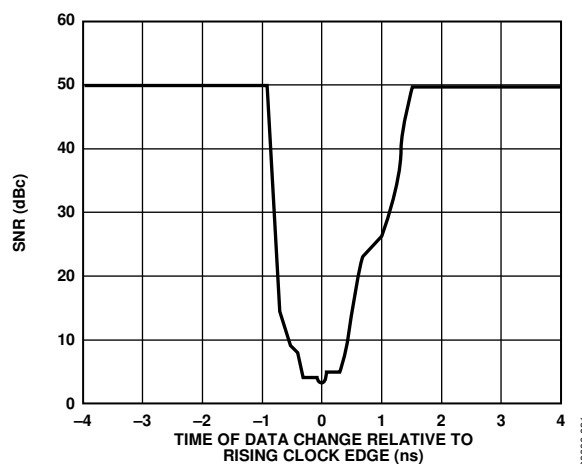

Figure 32. SNR vs. Clock Placement @ $f_{OUT} = 20$ MHz and $f_{CLK} = 125$ MSPS

SLEEP MODE OPERATION

The AD9709 has a power-down function that turns off the output current and reduces the supply current to less than 8.5 mA over the specified supply range of 3.3 V to 5 V and temperature range. This mode can be activated by applying a Logic Level 1 to the SLEEP pin. The SLEEP pin logic threshold is equal to $0.5 \times AVDD$. This digital input also contains an active pull-down circuit that ensures the AD9709 remains enabled if this input is left disconnected. The AD9709 requires less than 50 ns to power down and approximately 5 μ s to power back up.

POWER DISSIPATION

The power dissipation, P_D , of the AD9709 is dependent on several factors, including

- the power supply voltages ($AVDD$ and $DVDD1/DVDD2$)
- the full-scale current output (I_{OUTFS})
- the update rate (f_{CLK})
- the reconstructed digital input waveform

The power dissipation is directly proportional to the analog supply current, I_{AVDD} , and the digital supply current, I_{DVDD} . I_{AVDD} is directly proportional to I_{OUTFS} , as shown in Figure 33, and is insensitive to f_{CLK} .

Conversely, I_{DVDD} is dependent on the digital input waveform, f_{CLK} , and digital supply ($DVDD1/DVDD2$). Figure 34 and Figure 35 show I_{DVDD} as a function of full-scale sine wave output ratios (f_{OUT}/f_{CLK}) for various update rates with $DVDD1 = DVDD2 = 5$ V and $DVDD1 = DVDD2 = 3.3$ V, respectively. Note how I_{DVDD} is reduced by more than a factor of 2 when $DVDD1/DVDD2$ is reduced from 5 V to 3.3 V.

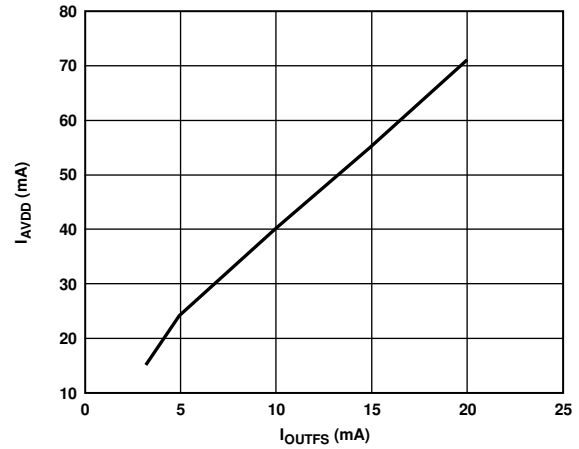

Figure 33. I_{AVDD} vs. I_{OUTFS}

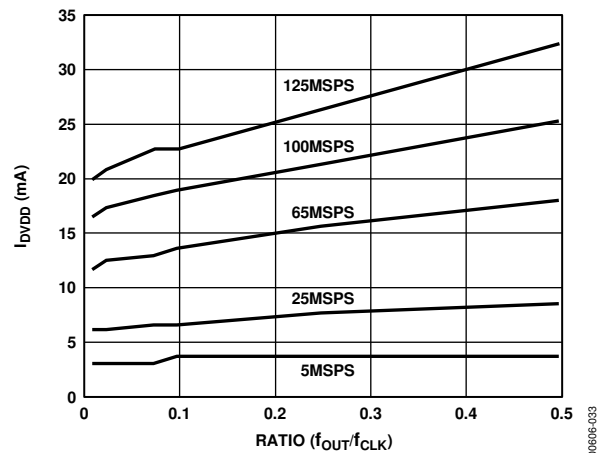

Figure 34. I_{DVDD} vs. Ratio @ $DVDD1 = DVDD2 = 5$ V

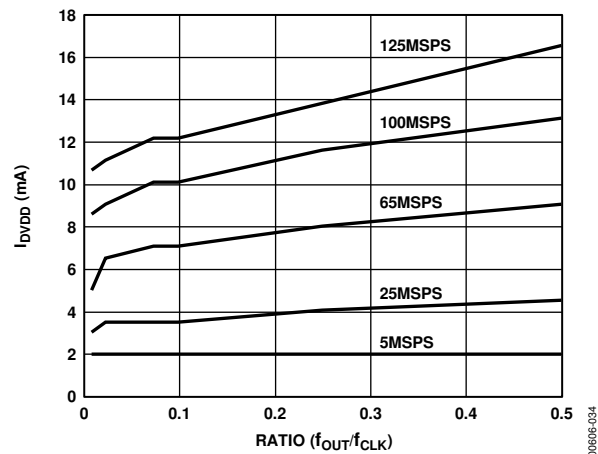

Figure 35. I_{DVDD} vs. Ratio @ $DVDD1 = DVDD2 = 3.3$ V

APPLYING THE AD9709 OUTPUT CONFIGURATIONS

The following sections illustrate some typical output configurations for the AD9709. Unless otherwise noted, it is assumed that I_{OUTFS} is set to a nominal 20 mA. For applications requiring the optimum dynamic performance, a differential output configuration is suggested. A differential output configuration can consist of either an RF transformer or a differential op amp configuration. The transformer configuration provides the optimum high frequency performance and is recommended for any application allowing for ac coupling. The differential op amp configuration is suitable for applications requiring dc coupling, bipolar output, signal gain, and/or level shifting, within the bandwidth of the chosen op amp.

A single-ended output is suitable for applications requiring a unipolar voltage output. A positive unipolar output voltage results if I_{OUTA} and/or I_{OUTB} is connected to an appropriately sized load resistor, R_{LOAD} , referred to ACOM. This configuration may be more suitable for a single-supply system requiring a dc-coupled, ground-referred output voltage. Alternatively, an amplifier can be configured as an I-V converter, thus converting I_{OUTA} or I_{OUTB} into a negative unipolar voltage. This configuration provides the best dc linearity because I_{OUTA} or I_{OUTB} is maintained at a virtual ground. Note that I_{OUTA} provides slightly better performance than I_{OUTB} .

DIFFERENTIAL COUPLING USING A TRANSFORMER

An RF transformer can be used as shown in Figure 36 to perform a differential-to-single-ended signal conversion. A differentially coupled transformer output provides the optimum distortion performance for output signals whose spectral content lies within the pass band of the transformer. An RF transformer such as the Mini-Circuits® T1-1T provides excellent rejection of common-mode distortion (that is, even-order harmonics) and noise over a wide frequency range. It also provides electrical isolation and the ability to deliver twice the power to the load. Transformers with different impedance ratios can also be used for impedance matching purposes. Note that the transformer provides ac coupling only.

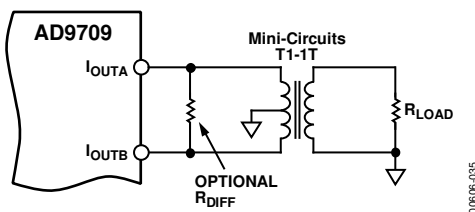

Figure 36. Differential Output Using a Transformer

The center tap on the primary side of the transformer must be connected to ACOM to provide the necessary dc current path for both I_{OUTA} and I_{OUTB} . The complementary voltages appearing at I_{OUTA} and I_{OUTB} (that is, V_{OUTA} and V_{OUTB}) swing symmetrically around ACOM and should be maintained with the specified output compliance range of the AD9709. A differential resistor,

R_{DIFF} , can be inserted in applications where the output of the transformer is connected to the load, R_{LOAD} , via a passive reconstruction filter or cable. R_{DIFF} is determined by the transformer's impedance ratio and provides the proper source termination that results in a low VSWR. Note that approximately half the signal power will be dissipated across R_{DIFF} .

DIFFERENTIAL COUPLING USING AN OP AMP

An op amp can also be used as shown in Figure 37 to perform a differential-to-single-ended conversion. The AD9709 is configured with two equal load resistors, R_{LOAD} , of 25 Ω each. The differential voltage developed across I_{OUTA} and I_{OUTB} is converted to a single-ended signal via the differential op amp configuration. An optional capacitor can be installed across I_{OUTA} and I_{OUTB} , forming a real pole in a low-pass filter. The addition of this capacitor also enhances the op amp's distortion performance by preventing the DAC's high-slewing output from overloading the op amp's input.

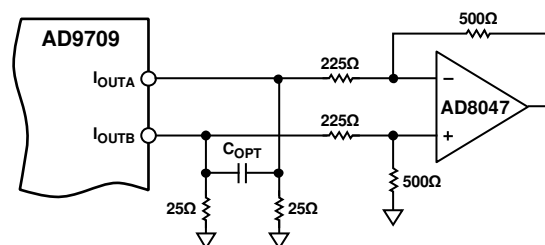

Figure 37. DC Differential Coupling Using an Op Amp

The common-mode rejection of this configuration is typically determined by the resistor matching. In this circuit, the differential op amp circuit using the AD8047 is configured to provide some additional signal gain. The op amp must operate from a dual supply because its output is approximately ± 1.0 V. A high speed amplifier capable of preserving the differential performance of the AD9709 while meeting other system level objectives (that is, cost and power) should be selected. The op amp's differential gain, gain setting resistor values, and full-scale output swing capabilities should be considered when optimizing this circuit.

The differential circuit shown in Figure 38 provides the necessary level shifting required in a single-supply system. In this case, $AVDD$, which is the positive analog supply for both the AD9709 and the op amp, is used to level shift the differential output of the AD9709 to midsupply (that is, $AVDD/2$). The AD8041 is a suitable op amp for this application.

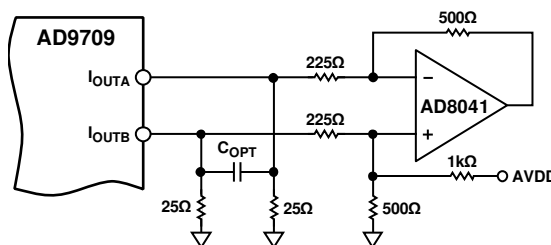

Figure 38. Single-Supply DC Differential Coupled Circuit

SINGLE-ENDED, UNBUFFERED VOLTAGE OUTPUT

Figure 39 shows the AD9709 configured to provide a unipolar output range of approximately 0 V to 0.5 V for a doubly terminated 50 Ω cable, because the nominal full-scale current, I_{OUTFS} , of 20 mA flows through the equivalent R_{LOAD} of 25 Ω. In this case, R_{LOAD} represents the equivalent load resistance seen by I_{OUTA} or I_{OUTB} . The unused output (I_{OUTA} or I_{OUTB}) can be connected directly to ACOM or via a matching R_{LOAD} . Different values of I_{OUTFS} and R_{LOAD} can be selected as long as the positive compliance range is adhered to. One additional consideration in this mode is the INL (see the Analog Outputs section). For optimum INL performance, the single-ended, buffered voltage output configuration is suggested.

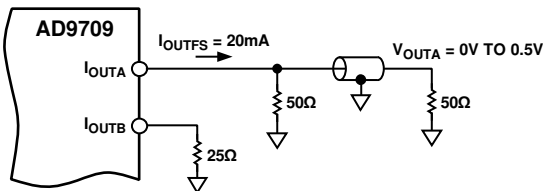

Figure 39. 0 V to 0.5 V Unbuffered Voltage Output

SINGLE-ENDED, BUFFERED VOLTAGE OUTPUT CONFIGURATION

Figure 40 shows a buffered single-ended output configuration in which the U1 op amp performs an I-V conversion on the AD9709 output current. U1 maintains I_{OUTA} (or I_{OUTB}) at a virtual ground, thus minimizing the nonlinear output impedance effect on the INL performance of the DAC, as discussed in the Analog Outputs section. Although this single-ended configuration typically provides the best dc linearity performance, its ac distortion performance at higher DAC update rates may be limited by the slewing capabilities of U1. U1 provides a negative unipolar output voltage, and its full-scale output voltage is simply the product of R_{FB} and I_{OUTFS} . The full-scale output should be set within U1's voltage output swing capabilities by scaling I_{OUTFS} and/or R_{FB} . An improvement in ac distortion performance may result with a reduced I_{OUTFS} because the signal current U1 has to sink will be subsequently reduced.

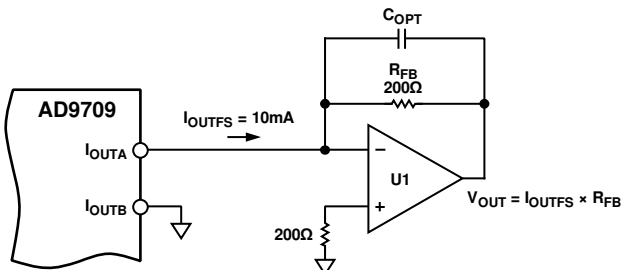

Figure 40. Unipolar Buffered Voltage Output

POWER AND GROUNDING CONSIDERATIONS

Power Supply Rejection

Many applications seek high speed and high performance under less than ideal operating conditions. In these applications, the implementation and construction of the printed circuit board is as important as the circuit design. Proper RF techniques must be used for device selection, placement, and routing as well as power supply bypassing and grounding to ensure optimum performance. Figure 52 and Figure 53 illustrate the recommended circuit board layout, including ground, power, and signal input/output.

One factor that can measurably affect system performance is the ability of the DAC output to reject dc variations or ac noise superimposed on the analog or digital dc power distribution. This is referred to as the power supply rejection ratio (PSRR). For dc variations of the power supply, the resulting performance of the DAC directly corresponds to a gain error associated with the DAC's full-scale current, I_{OUTFS} . AC noise on the dc supplies is common in applications where the power distribution is generated by a switching power supply. Typically, switching power supply noise occurs over the spectrum from tens of kilohertz to several megahertz. The PSRR vs. frequency of the AD9709 AVDD supply over this frequency range is shown in Figure 41.

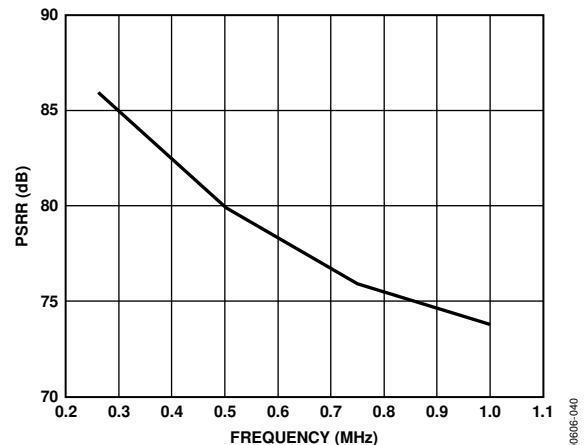

Figure 41. AVDD Power Supply Rejection Ratio vs. Frequency

Note that the data in Figure 41 is given in terms of current out vs. voltage in. Noise on the analog power supply has the effect of modulating the internal current sources and therefore the output current. The voltage noise on AVDD, therefore, is added in a nonlinear manner to the desired I_{OUT} . PSRR is very code dependent, thus producing mixing effects that can modulate low frequency power supply noise to higher frequencies. Worst-case PSRR for either one of the differential DAC outputs occurs when the full-scale current is directed toward that output. As a result, the PSRR measurement in Figure 41 represents a worst-case condition in which the digital inputs remain static and the full-scale output current of 20 mA is directed to the DAC output being measured.

An example serves to illustrate the effect of supply noise on the analog supply. Suppose a switching regulator with a switching frequency of 250 kHz produces 10 mV of noise and, for simplicity's sake, all of this noise is concentrated at 250 kHz (that is, ignore harmonics). To calculate how much of this undesired noise will appear as current noise superimposed on the DAC full-scale current, I_{OUTFS} , one must determine the PSRR in decibels using Figure 41 at 250 kHz. To calculate the PSRR for a given R_{LOAD} , such that the units of PSRR are converted from A/V to V/V, adjust the curve in Figure 41 by the scaling factor $20 \times \log(R_{LOAD})$. For instance, if R_{LOAD} is 50 Ω , the PSRR is reduced by 34 dB (that is, the PSRR of the DAC at 250 kHz, which is 85 dB in Figure 41, becomes 51 dB V_{OUT}/V_{IN}).

Proper grounding and decoupling should be a primary objective in any high speed, high resolution system. The AD9709 features separate analog and digital supply and ground pins to optimize the management of analog and digital ground currents in a system. In general, decouple the analog supply

(AVDD) to the analog common (ACOM) as close to the chip as physically possible. Similarly, decouple DVDD1/DVDD2, the digital supply (DVDD1/DVDD2) to the digital common (DCOM1/DCOM2) as close to the chip as possible.

For applications that require a single 5 V or 3.3 V supply for both the analog and digital supplies, a clean analog supply can be generated using the circuit shown in Figure 42. The circuit consists of a differential LC filter with separate power supply and return lines. Lower noise can be attained by using low-ESR type electrolytic and tantalum capacitors.

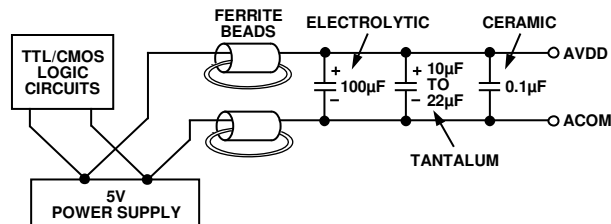

Figure 42. Differential LC Filter for Single 5 V and 3.3 V Applications

00805-041

APPLICATIONS INFORMATION

QUADRATURE AMPLITUDE MODULATION (QAM) USING THE AD9709

QAM is one of the most widely used digital modulation schemes in digital communications systems. This modulation technique can be found in FDM as well as spread spectrum (that is, CDMA) based systems. A QAM signal is a carrier frequency that is modulated in both amplitude (that is, AM modulation) and phase (that is, PM modulation). It can be generated by independently modulating two carriers of identical frequency but with a 90° phase difference. This results in an in-phase (I) carrier component and a quadrature (Q) carrier component at a 90° phase shift with respect to the I component. The I and Q components are then summed to provide a QAM signal at the specified carrier frequency.

A common and traditional implementation of a QAM modulator is shown in Figure 43. The modulation is performed in the analog domain in which two DACs are used to generate the baseband I and Q components. Each component is then typically applied to a Nyquist filter before being applied to a quadrature mixer. The matching Nyquist filters shape and limit each component's spectral envelope while minimizing intersymbol interference. The DAC is typically updated at the QAM symbol rate, or at a multiple of the QAM symbol rate if an interpolating filter precedes the DAC. The use of an interpolating filter typically eases the implementation and complexity of the analog filter, which can be a significant contributor to mismatches in gain and phase between the two baseband channels. A quadrature mixer modulates the I and Q components with the in-phase and quadrature carrier frequencies and then sums the two outputs to provide the QAM signal.

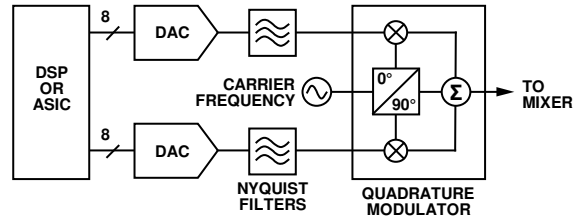

Figure 43. Typical Analog QAM Architecture

In this implementation, it is much more difficult to maintain proper gain and phase matching between the I and Q channels. The circuit implementation shown in Figure 44 helps improve the matching between the I and Q channels, and it shows a path for upconversion using the AD8346 quadrature modulator. The AD9709 provides both I and Q DACs with a common reference that will improve the gain matching and stability. R_{CAL} can be used to compensate for any mismatch in gain between the two channels. The mismatch may be attributed to the mismatch between R_{SET1} and R_{SET2} , the effective load resistance of each channel, and/or the voltage offset of the control amplifier in each DAC. The differential voltage outputs of both DACs in the AD9709 are fed into the respective differential inputs of the AD8346 via matching networks.

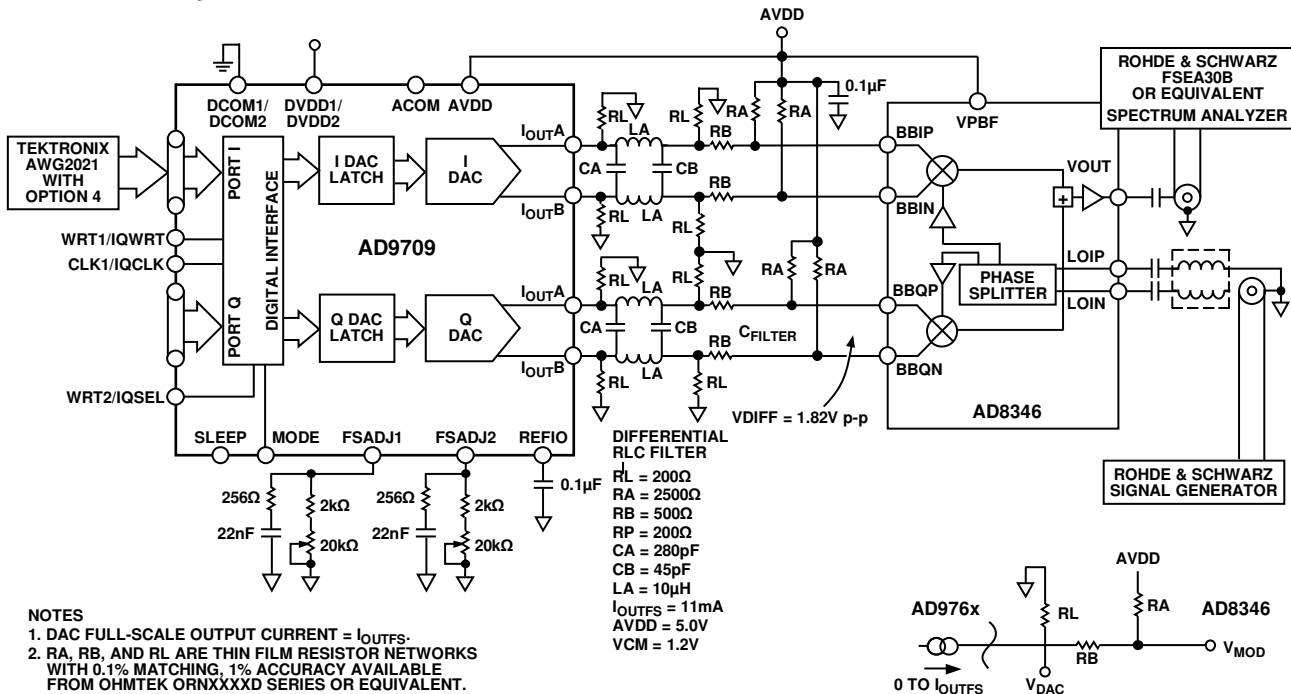

Figure 44. Baseband QAM Implementation Using an AD9709 and AD8346

I and Q digital data can be fed into the AD9709 in two ways. In dual port mode, the digital I information drives one input port, and the digital Q information drives the other input port. If no interpolation filter precedes the DAC, the symbol rate is the rate at which the system clock drives the CLK and WRT pins on the AD9709. In interleaved mode, the digital input stream at Port 1 contains the I and the Q information in alternating digital words. Using IQSEL and IQRESET, the AD9709 can be synchronized to the I and Q data streams. The internal timing of the AD9709 routes the selected I and Q data to the correct DAC output. In interleaved mode, if no interpolation filter precedes the AD9709, the symbol rate is half that of the system clock driving the digital data stream and the IQWRT and IQCLK pins on the AD9709.

CDMA

Code division multiple access (CDMA) is an air transmit/receive scheme where the signal in the transmit path is modulated with a pseudorandom digital code (sometimes referred to as the spreading code). The effect of this is to spread the transmitted signal across a wide spectrum. Similar to a discrete multitone (DMT) waveform, a CDMA waveform containing multiple subscribers can be characterized as having a high peak to average ratio (that is, crest factor), thus demanding highly linear components in the transmit signal path. The bandwidth of the spectrum is defined by the CDMA standard being used, and in operation it is implemented by using a spreading code with particular characteristics.

Distortion in the transmit path can lead to power being transmitted out of the defined band. The ratio of power transmitted in-band to out-of-band is often referred to as adjacent channel power (ACP). This is a regulatory issue due to the possibility of interference with other signals being transmitted by air. Regulatory bodies define a spectral mask outside of the transmit band, and the ACP must fall under this mask. If distortion in the transmit path causes the ACP to be above the spectral mask, filtering or different component selection is needed to meet the mask requirements.

Figure 45 displays the results of using the application circuit shown in Figure 44 to reconstruct a wideband CDMA (W-CDMA) test vector using a bandwidth of 8 MHz that is centered at 2.4 GHz and sampled at 65 MHz. The IF frequency at the DAC output is 15.625 MHz. The adjacent channel power ratio (ACPR) for the given test vector is measured at greater than 54 dB.

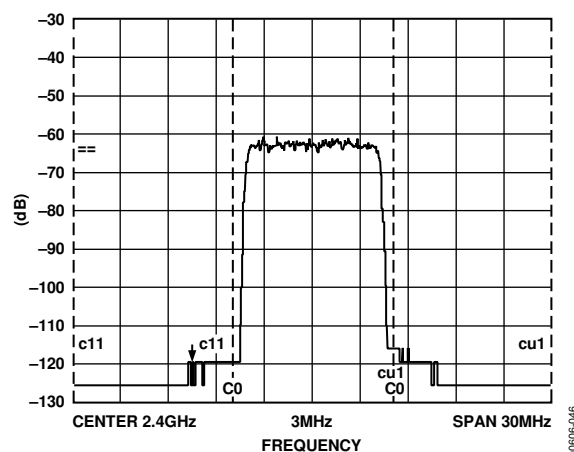

Figure 45. CDMA Signal, 8 MHz Chip Rate Sampled at 65 MSPS, Recreated at 2.4 GHz, Adjacent Channel Power > 54 dB

EVALUATION BOARD

GENERAL DESCRIPTION

The AD9709-EB is an evaluation board for the AD9709 8-bit dual DAC. Careful attention to layout and circuit design, combined with a prototyping area, allow the user to easily and effectively evaluate the AD9709 in any application where high resolution, high speed conversion is required.

This board allows the user flexibility to operate the AD9709 in various configurations. Possible output configurations include transformer coupled, resistor terminated, and single-ended and differential outputs. The digital inputs can be used in dual port or interleaved mode and are designed to be driven from various word generators, with the on-board option to add a resistor network for proper load termination. When operating the AD9709, best performance is obtained when running the digital supply (DVDD1/DVDD2) at 3.3 V and the analog supply (AVDD) at 5 V.

SCHEMATICS

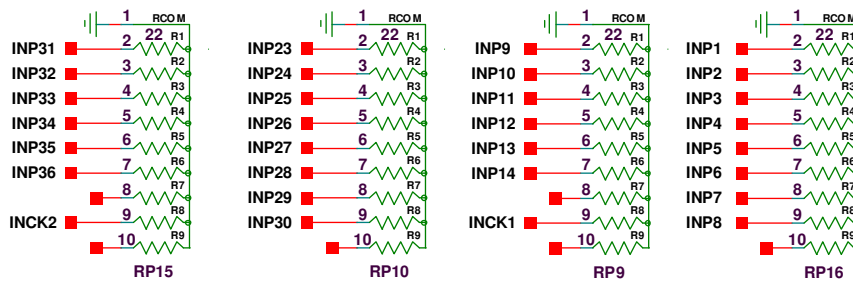
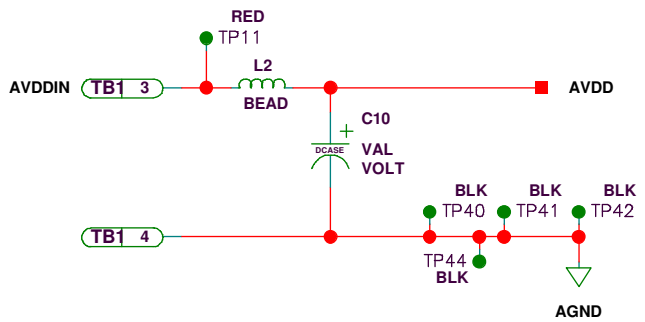
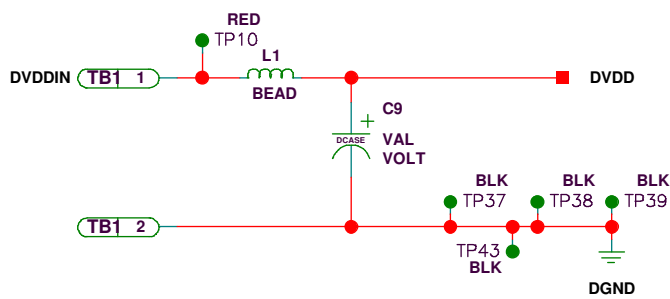

Figure 46. Power Decoupling and Clocks on AD9709 Evaluation Board (1)

006506-146