



Chipsmall Limited consists of a professional team with an average of over 10 year of expertise in the distribution of electronic components. Based in Hongkong, we have already established firm and mutual-benefit business relationships with customers from,Europe,America and south Asia,supplying obsolete and hard-to-find components to meet their specific needs.

With the principle of “Quality Parts,Customers Priority,Honest Operation,and Considerate Service”,our business mainly focus on the distribution of electronic components. Line cards we deal with include Microchip,ALPS,ROHM,Xilinx,Pulse,ON,Everlight and Freescale. Main products comprise IC,Modules,Potentiometer,IC Socket,Relay,Connector.Our parts cover such applications as commercial,industrial, and automotives areas.

We are looking forward to setting up business relationship with you and hope to provide you with the best service and solution. Let us make a better world for our industry!



## Contact us

Tel: +86-755-8981 8866 Fax: +86-755-8427 6832

Email & Skype: info@chipsmall.com Web: www.chipsmall.com

Address: A1208, Overseas Decoration Building, #122 Zhenhua RD., Futian, Shenzhen, China



## FEATURES

High performance member of pin-compatible TxDAC product family

Excellent spurious-free dynamic range performance  
SNR at 5 MHz output, 125 MSPS: 70 dB

Twos complement or straight binary data format

Differential current outputs: 2 mA to 20 mA

Power dissipation: 135 mW at 3.3 V

Power-down mode: 15 mW at 3.3 V

On-chip 1.2 V Reference

CMOS compatible digital interface

28-lead SOIC, 28-lead TSSOP, and 32-lead LFCSP

Edge-triggered latches

## APPLICATIONS

Wideband communication transmit channel:

Direct IF

Base stations

Wireless local loops

Digital radio links

Direct digital synthesis (DDS)

Instrumentation

## GENERAL DESCRIPTION

The AD9742<sup>1</sup> is a 12-bit resolution, wideband, third generation member of the TxDAC series of high performance, low power CMOS digital-to-analog converters (DACs). The TxDAC family, consisting of pin-compatible 8-, 10-, 12-, and 14-bit DACs, is specifically optimized for the transmit signal path of communication systems. All of the devices share the same interface options, small outline package, and pinout, providing an upward or downward component selection path based on performance, resolution, and cost. The AD9742 offers exceptional ac and dc performance while supporting update rates up to 210 MSPS.

The AD9742's low power dissipation makes it well suited for portable and low power applications. Its power dissipation can be further reduced to a mere 60 mW with a slight degradation in performance by lowering the full-scale current output. Also, a power-down mode reduces the standby power dissipation to approximately 15 mW. A segmented current source architecture is combined with a proprietary switching technique to reduce spurious components and enhance dynamic performance.

<sup>1</sup> Protected by U.S. Patent Numbers: 5,568,145; 5,689,257; and 5,703,519.

Rev. C

[Document Feedback](#)

Information furnished by Analog Devices is believed to be accurate and reliable. However, no responsibility is assumed by Analog Devices for its use, nor for any infringements of patents or other rights of third parties that may result from its use. Specifications subject to change without notice. No license is granted by implication or otherwise under any patent or patent rights of Analog Devices. Trademarks and registered trademarks are the property of their respective owners.

## FUNCTIONAL BLOCK DIAGRAM

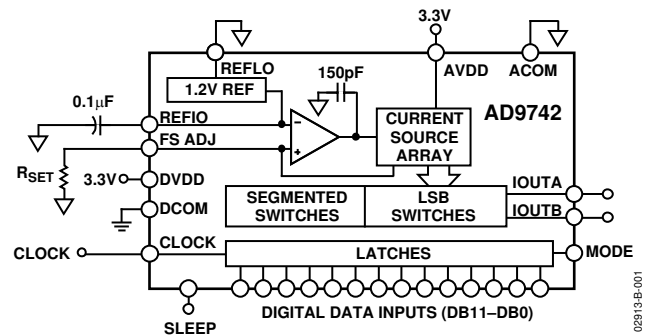

Figure 1.

Edge-triggered input latches and a 1.2 V temperature compensated band gap reference have been integrated to provide a complete monolithic DAC solution. The digital inputs support 3 V CMOS logic families.

## PRODUCT HIGHLIGHTS

1. The AD9742 is the 12-bit member of the pin-compatible TxDAC family, which offers excellent INL and DNL performance.
2. Data input supports twos complement or straight binary data coding.
3. High speed, single-ended CMOS clock input supports 210 MSPS conversion rate.
4. Low power: Complete CMOS DAC function operates on 135 mW from a 2.7 V to 3.6 V single supply. The DAC full-scale current can be reduced for lower power operation, and a sleep mode is provided for low power idle periods.
5. On-chip voltage reference: The AD9742 includes a 1.2 V temperature compensated band gap voltage reference.
6. Industry-standard 28-lead SOIC, 28-lead TSSOP, and 32-lead LFCSP packages.

# AD9742\* PRODUCT PAGE QUICK LINKS

Last Content Update: 02/23/2017

---

## COMPARABLE PARTS

View a parametric search of comparable parts.

## EVALUATION KITS

- AD9742 Evaluation Board

## DOCUMENTATION

### Application Notes

- AN-237: Choosing DACs for Direct Digital Synthesis
- AN-302: Exploit Digital Advantages in an SSB Receiver
- AN-320A: CMOS Multiplying DACs and Op Amps Combine to Build Programmable Gain Amplifier, Part 1
- AN-595: Understanding Pin Compatibility in the TxDAC® Line of High Speed D/A Converters
- AN-642: Coupling a Single-Ended Clock Source to the Differential Clock Input of Third-Generation TxDAC® and TxDAC+® Products
- AN-912: Driving a Center-Tapped Transformer with a Balanced Current-Output DAC

### Data Sheet

- AD9742: 12-Bit, 210 MSPS TxDAC Digital-to-Analog Converter Data Sheet

## TOOLS AND SIMULATIONS

- AD9742 IBIS Models

## REFERENCE MATERIALS

### Informational

- Advantiv™ Advanced TV Solutions

### Solutions Bulletins & Brochures

- Digital to Analog Converters ICs Solutions Bulletin

## DESIGN RESOURCES

- AD9742 Material Declaration
- PCN-PDN Information
- Quality And Reliability
- Symbols and Footprints

## DISCUSSIONS

View all AD9742 EngineerZone Discussions.

## SAMPLE AND BUY

Visit the product page to see pricing options.

## TECHNICAL SUPPORT

Submit a technical question or find your regional support number.

## DOCUMENT FEEDBACK

Submit feedback for this data sheet.



## TABLE OF CONTENTS

Features .....	1	Reference Control Amplifier .....	13
Applications .....	1	DAC Transfer Function .....	13
Functional Block Diagram .....	1	Analog Outputs .....	13
General Description .....	1	Digital Inputs .....	14
Product Highlights .....	1	Clock Input .....	14
Revision History .....	2	DAC Timing .....	15
Specifications .....	3	Power Dissipation .....	15
DC Specifications .....	3	Applying the AD9742 .....	16
Dynamic Specifications .....	4	Differential Coupling Using a Transformer .....	16
Digital Specifications .....	5	Differential Coupling Using an Op Amp .....	16
Absolute Maximum Ratings .....	6	Single-Ended, Unbuffered Voltage Output .....	17
Thermal Resistance .....	6	Single-Ended, Buffered Voltage Output Configuration .....	17
ESD Caution .....	6	Power and Grounding Considerations, Power Supply Rejection .....	17
Pin Configurations and Function Descriptions .....	7	Evaluation Board .....	19
Typical Performance Characteristics .....	8	General Description .....	19
Terminology .....	11	Outline Dimensions .....	29
Functional Description .....	12	Ordering Guide .....	30
Reference Operation .....	12		

## REVISION HISTORY

### 2/13—Rev. B to Rev. C

Updated Format .....	Universal
Changes to Figure 4 and Table 6 .....	7
Moved Terminology Section .....	11
Updated Outline Dimensions .....	29
Changes to Ordering Guide .....	30

### 6/04—Rev. A to Rev. B

Changes to the Title, General Description, and Product Highlights .....	1
Changes to Dynamic Specifications .....	4
Changes to Figure 6 and Figure 10 .....	9
Changes to Figure 12 to Figure 15 .....	10
Changes to the Functional Description Section .....	12
Changes to the Digital Inputs Section .....	14
Changes to Figure 29 .....	15
Changes to Figure 30 .....	16

### 5/03—Rev. 0 to Rev. A

Added 32-Lead LFCSP Package .....	Universal
Edits to Features and Product Highlights .....	1
Edits to DC Specifications .....	2
Edits to Dynamic Specifications .....	3
Edits to Digital Specifications .....	4
Edits to Absolute Maximum Ratings, Thermal Characteristics, and Ordering Guide .....	5
Edits to Pin Configuration and Pin Function Descriptions .....	6
Edits to Figure 2 .....	7
Replaced TPCs 1, 4, 7, and 8 .....	8
Edits to Figure 3 and Functional Description Section .....	10
Added Clock Input Section and Figure 7 .....	12
Edits to DAC Timing Section .....	12
Edits to Sleep Mode Operation Section and Power Dissipation Section .....	13
Renumbered Figure 8 to Figure 26 .....	13
Added Figure 11 .....	13
Added Figure 27 to Figure 35 .....	21
Updated Outline Dimensions .....	26

### 5/02—Revision 0: Initial Version

# SPECIFICATIONS

## DC SPECIFICATIONS

$T_{MIN}$  to  $T_{MAX}$ ,  $AVDD = 3.3$  V,  $DVDD = 3.3$  V,  $CLKVDD = 3.3$  V,  $I_{OUTFS} = 20$  mA, unless otherwise noted.

Table 1.

Parameter	Min	Typ	Max	Unit
RESOLUTION	12			Bits
DC ACCURACY <sup>1</sup>				
Integral Linearity Error (INL)	-2.5	±0.5	+2.5	LSB
Differential Nonlinearity (DNL)	-1.3	±0.4	+1.3	LSB
ANALOG OUTPUT				
Offset Error	-0.02		+0.02	% of FSR
Gain Error (Without Internal Reference)	-0.5	±0.1	+0.5	% of FSR
Gain Error (With Internal Reference)	-0.5	±0.1	+0.5	% of FSR
Full-Scale Output Current <sup>2</sup>	2		20	mA
Output Compliance Range	-1		+1.25	V
Output Resistance		100		kΩ
Output Capacitance		5		pF
REFERENCE OUTPUT				
Reference Voltage	1.14	1.20	1.26	V
Reference Output Current <sup>3</sup>		100		nA
REFERENCE INPUT				
Input Compliance Range	0.1		1.25	V
Reference Input Resistance (Ext. Reference)		1		MΩ
Small Signal Bandwidth		0.5		MHz
TEMPERATURE COEFFICIENTS				
Offset Drift		0		ppm of FSR/°C
Gain Drift (Without Internal Reference)		±50		ppm of FSR/°C
Gain Drift (With Internal Reference)		±100		ppm of FSR/°C
Reference Voltage Drift		±50		ppm/°C
POWER SUPPLY				
Supply Voltages				
AVDD	2.7	3.3	3.6	V
DVDD	2.7	3.3	3.6	V
CLKVDD	2.7	3.3	3.6	V
Analog Supply Current ( $I_{AVDD}$ )		33	36	mA
Digital Supply Current ( $I_{DVDD}$ ) <sup>4</sup>		8	9	mA
Clock Supply Current ( $I_{CLKVDD}$ )		5	6	mA
Supply Current Sleep Mode ( $I_{AVDD}$ )		5	6	mA
Power Dissipation <sup>4</sup>		135	145	mW
Power Dissipation <sup>5</sup>		145		mW
Power Supply Rejection Ratio—AVDD <sup>6</sup>	-1		+1	% of FSR/V
Power Supply Rejection Ratio—DVDD <sup>6</sup>	-0.04		+0.04	% of FSR/V
OPERATING RANGE	-40		+85	°C

<sup>1</sup> Measured at IOUTA, driving a virtual ground.

<sup>2</sup> Nominal full-scale current,  $I_{OUTFS}$ , is 32 times the  $I_{REF}$  current.

<sup>3</sup> An external buffer amplifier with input bias current <100 nA should be used to drive any external load.

<sup>4</sup> Measured at  $f_{CLOCK} = 25$  MSPS and  $f_{OUT} = 1$  MHz.

<sup>5</sup> Measured as unbuffered voltage output with  $I_{OUTFS} = 20$  mA and 50 Ω  $R_{LOAD}$  at IOUTA and IOUTB,  $f_{CLOCK} = 100$  MSPS and  $f_{OUT} = 40$  MHz.

<sup>6</sup> ±5% power supply variation.

**DYNAMIC SPECIFICATIONS**

$T_{MIN}$  to  $T_{MAX}$ , AVDD = 3.3 V, DVDD = 3.3 V, CLKVDD = 3.3 V,  $I_{OUTFS} = 20$  mA, differential transformer coupled output, 50  $\Omega$  doubly terminated, unless otherwise noted.

**Table 2.**

Parameter	Min	Typ	Max	Unit
<b>DYNAMIC PERFORMANCE</b>				
Maximum Output Update Rate ( $f_{CLOCK}$ )	210			MSPS
Output Settling Time ( $t_{ST}$ ) (to 0.1%) <sup>1</sup>		11		ns
Output Propagation Delay ( $t_{PD}$ )		1		ns
Glitch Impulse		5		pV-sec
Output Rise Time (10% to 90%) <sup>1</sup>		2.5		ns
Output Fall Time (10% to 90%) <sup>1</sup>		2.5		ns
Output Noise ( $I_{OUTFS} = 20$ mA) <sup>2</sup>		50		pA/ $\sqrt{Hz}$
Output Noise ( $I_{OUTFS} = 2$ mA) <sup>2</sup>		30		pA/ $\sqrt{Hz}$
Noise Spectral Density <sup>3</sup>		-152		dBm/Hz
<b>AC LINEARITY</b>				
<b>Spurious-Free Dynamic Range to Nyquist</b>				
$f_{CLOCK} = 25$ MSPS; $f_{OUT} = 1.00$ MHz				
0 dBFS Output	74	84		dBc
-6 dBFS Output		85		dBc
-12 dBFS Output		82		dBc
-18 dBFS Output		76		dBc
$f_{CLOCK} = 65$ MSPS; $f_{OUT} = 1.00$ MHz		85		dBc
$f_{CLOCK} = 65$ MSPS; $f_{OUT} = 2.51$ MHz		83		dBc
$f_{CLOCK} = 65$ MSPS; $f_{OUT} = 10$ MHz		80		dBc
$f_{CLOCK} = 65$ MSPS; $f_{OUT} = 15$ MHz		75		dBc
$f_{CLOCK} = 65$ MSPS; $f_{OUT} = 25$ MHz		74		dBc
$f_{CLOCK} = 165$ MSPS; $f_{OUT} = 21$ MHz		72		dBc
$f_{CLOCK} = 165$ MSPS; $f_{OUT} = 41$ MHz		60		dBc
$f_{CLOCK} = 210$ MSPS; $f_{OUT} = 40$ MHz		67		dBc
$f_{CLOCK} = 210$ MSPS; $f_{OUT} = 69$ MHz		60		dBc
<b>Spurious-Free Dynamic Range within a Window</b>				
$f_{CLOCK} = 25$ MSPS; $f_{OUT} = 1.00$ MHz; 2 MHz Span	80			dBc
$f_{CLOCK} = 50$ MSPS; $f_{OUT} = 5.02$ MHz; 2 MHz Span		90		dBc
$f_{CLOCK} = 65$ MSPS; $f_{OUT} = 5.03$ MHz; 2.5 MHz Span		90		dBc
$f_{CLOCK} = 125$ MSPS; $f_{OUT} = 5.04$ MHz; 4 MHz Span		90		dBc
<b>Total Harmonic Distortion</b>				
$f_{CLOCK} = 25$ MSPS; $f_{OUT} = 1.00$ MHz		-82	-74	dBc
$f_{CLOCK} = 50$ MSPS; $f_{OUT} = 2.00$ MHz		-77		dBc
$f_{CLOCK} = 65$ MSPS; $f_{OUT} = 2.00$ MHz		-77		dBc
$f_{CLOCK} = 125$ MSPS; $f_{OUT} = 2.00$ MHz		-77		dBc
<b>Signal-to-Noise Ratio</b>				
$f_{CLOCK} = 65$ MSPS; $f_{OUT} = 5$ MHz; $I_{OUTFS} = 20$ mA		78		dB
$f_{CLOCK} = 65$ MSPS; $f_{OUT} = 5$ MHz; $I_{OUTFS} = 5$ mA		86		dB
$f_{CLOCK} = 125$ MSPS; $f_{OUT} = 5$ MHz; $I_{OUTFS} = 20$ mA		73		dB
$f_{CLOCK} = 125$ MSPS; $f_{OUT} = 5$ MHz; $I_{OUTFS} = 5$ mA		78		dB
$f_{CLOCK} = 165$ MSPS; $f_{OUT} = 5$ MHz; $I_{OUTFS} = 20$ mA		69		dB
$f_{CLOCK} = 165$ MSPS; $f_{OUT} = 5$ MHz; $I_{OUTFS} = 5$ mA		71		dB
$f_{CLOCK} = 210$ MSPS; $f_{OUT} = 5$ MHz; $I_{OUTFS} = 20$ mA		69		dB
$f_{CLOCK} = 210$ MSPS; $f_{OUT} = 5$ MHz; $I_{OUTFS} = 5$ mA		66		dB

Parameter	Min	Typ	Max	Unit
Multitone Power Ratio (8 Tones at 400 kHz Spacing) f <sub>CLOCK</sub> = 78 MSPS; f <sub>OUT</sub> = 15.0 MHz to 18.2 MHz				
0 dBFS Output		65		dBc
-6 dBFS Output		67		dBc
-12 dBFS Output		65		dBc
-18 dBFS Output		63		dBc

<sup>1</sup> Measured single-ended into 50 Ω load.

<sup>2</sup> Output noise is measured with a full-scale output set to 20 mA with no conversion activity. It is a measure of the thermal noise only.

<sup>3</sup> Noise spectral density is the average noise power normalized to a 1 Hz bandwidth, with the DAC converting and producing an output tone.

### DIGITAL SPECIFICATIONS

T<sub>MIN</sub> to T<sub>MAX</sub>, AVDD = 3.3 V, DVDD = 3.3 V, CLKVDD = 3.3 V, I<sub>OUTFS</sub> = 20 mA, unless otherwise noted.

Table 3.

Parameter	Min	Typ	Max	Unit
<b>DIGITAL INPUTS<sup>1</sup></b>				
Logic 1 Voltage	2.1	3		V
Logic 0 Voltage		0	0.9	V
Logic 1 Current	-10		+10	μA
Logic 0 Current	-10		+10	μA
Input Capacitance		5		pF
Input Setup Time (t <sub>S</sub> )	2.0			ns
Input Hold Time (t <sub>H</sub> )	1.5			ns
Latch Pulse Width (t <sub>LPW</sub> )	1.5			ns
<b>CLK INPUTS<sup>2</sup></b>				
Input Voltage Range	0		3	V
Common-Mode Voltage	0.75	1.5	2.25	V
Differential Voltage	0.5	1.5		V

<sup>1</sup> Includes CLOCK pin on SOIC/TSSOP packages and CLK+ pin on LFCSP package in single-ended clock input mode.

<sup>2</sup> Applicable to CLK+ and CLK- inputs when configured for differential or PECL clock input mode.

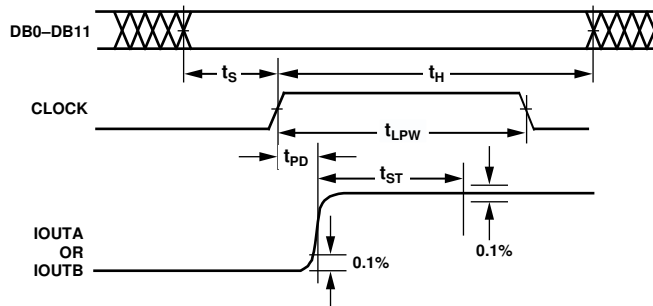

Figure 2. Timing Diagram

02812-B-1002

## ABSOLUTE MAXIMUM RATINGS

Table 4.

Parameter	With Respect to	Min	Max	Unit
AVDD	ACOM	-0.3	+3.9	V
DVDD	DCOM	-0.3	+3.9	V
CLKVDD	CLKCOM	-0.3	+3.9	V
ACOM	DCOM	-0.3	+0.3	V
ACOM	CLKCOM	-0.3	+0.3	V
DCOM	CLKCOM	-0.3	+0.3	V
AVDD	DVDD	-3.9	+3.9	V
AVDD	CLKVDD	-3.9	+3.9	V
DVDD	CLKVDD	-3.9	+3.9	V
CLOCK, SLEEP	DCOM	-0.3	DVDD + 0.3	V
Digital Inputs, MODE	DCOM	-0.3	DVDD + 0.3	V
IOUTA, IOUTB	ACOM	-1.0	AVDD + 0.3	V
REFIO, REFLO, FS ADJ	ACOM	-0.3	AVDD + 0.3	V
CLK+, CLK-, MODE	CLKCOM	-0.3	CLKVDD + 0.3	V
Junction Temperature			150	°C
Storage Temperature		-65	+150	°C
Lead Temperature (10 sec)			300	°C

Stresses above those listed under Absolute Maximum Ratings may cause permanent damage to the device. This is a stress rating only; functional operation of the device at these or any other conditions above those indicated in the operational section of this specification is not implied. Exposure to absolute maximum rating conditions for extended periods may affect device reliability.

## THERMAL RESISTANCE

Thermal impedance measurements were taken on a 4-layer board in still air, in accordance with EIA/JESD51-7.

Table 5. Thermal Resistance

Package Type	$\theta_{JA}$	Unit
28-Lead SOIC	55.9	°C/W
28-Lead TSSOP	67.7	°C/W
32-Lead LFCSP	32.5	°C/W

## ESD CAUTION



**ESD (electrostatic discharge) sensitive device.** Charged devices and circuit boards can discharge without detection. Although this product features patented or proprietary protection circuitry, damage may occur on devices subjected to high energy ESD. Therefore, proper ESD precautions should be taken to avoid performance degradation or loss of functionality.



### PIN CONFIGURATIONS AND FUNCTION DESCRIPTIONS

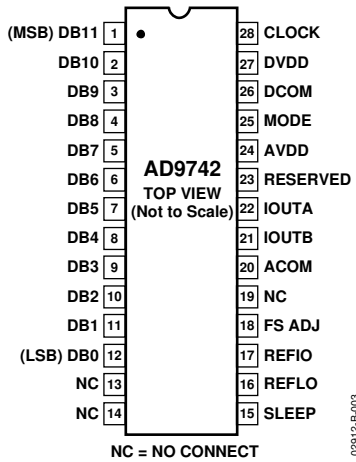
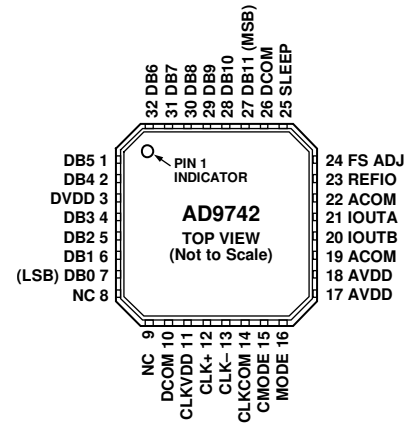

Figure 3. 28-Lead SOIC and 28-Lead TSSOP Pin Configuration



NOTES  
 1. NC = NO CONNECT.  
 2. IT IS RECOMMENDED THAT THE EXPOSED PAD BE THERMALLY CONNECTED TO A COPPER GROUND PLANE FOR ENHANCED ELECTRICAL AND THERMAL PERFORMANCE.

Figure 4. 32-Lead LFCSP Pin Configuration

Table 6. Pin Function Descriptions (N/A = Not Applicable)

SOIC/TSSOP Pin No.	LFCSP Pin No.	Mnemonic	Description
1	27	DB11	Most Significant Data Bit (MSB).
2 to 11	28 to 32, 1, 2, 4 to 6	DB10 to DB1	Data Bits 10 to 1.
12	7	DB0	Least Significant Data Bit (LSB).
13, 14	8, 9	NC	No Internal Connection.
15	25	SLEEP	Power-Down Control Input. Active high. Contains active pull-down circuit; it may be left unterminated if not used.
16	N/A	REFLO	Reference Ground when Internal 1.2 V Reference Used. Connect to AVDD to disable internal reference.
17	23	REFIO	Reference Input/Output. Serves as reference input when internal reference disabled (that is, tie REFLO to AVDD). Serves as 1.2 V reference output when internal reference activated (that is, tie REFLO to ACOM). Requires 0.1 $\mu$ F capacitor to ACOM when internal reference activated.
18	24	FS ADJ	Full-Scale Current Output Adjust.
19	N/A	NC	No Internal Connection.
20	19, 22	ACOM	Analog Common.
21	20	IOUTB	Complementary DAC Current Output. Full-scale current when all data bits are 0s.
22	21	IOUTA	DAC Current Output. Full-scale current when all data bits are 1s.
23	N/A	RESERVED	Reserved. Do not connect to common or supply.
24	17, 18	AVDD	Analog Supply Voltage (3.3 V).
25	16	MODE	Selects Input Data Format. Connect to DCOM for straight binary, DVDD for twos complement.
N/A	15	CMODE	Clock Mode Selection. Connect to CLKCOM for single-ended clock receiver (drive CLK+ and float CLK-). Connect to CLKVDD for differential receiver. Float for PECL receiver (terminations on-chip).
26	10, 26	DCOM	Digital Common.
27	3	DVDD	Digital Supply Voltage (3.3 V).
28	N/A	CLOCK	Clock Input. Data latched on positive edge of clock.
N/A	12	CLK+	Differential Clock Input.
N/A	13	CLK-	Differential Clock Input.
N/A	11	CLKVDD	Clock Supply Voltage (3.3 V).
N/A	14	CLKCOM	Clock Common.
N/A		EPAD	It is recommended that the exposed pad be thermally connected to a copper ground plane for enhanced electric and thermal performance.

TYPICAL PERFORMANCE CHARACTERISTICS

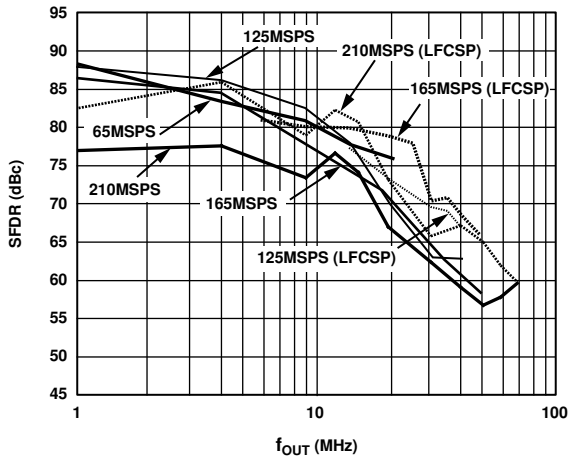

Figure 5. SFDR vs.  $f_{OUT}$  @ 0 dBFS

02912-B-006

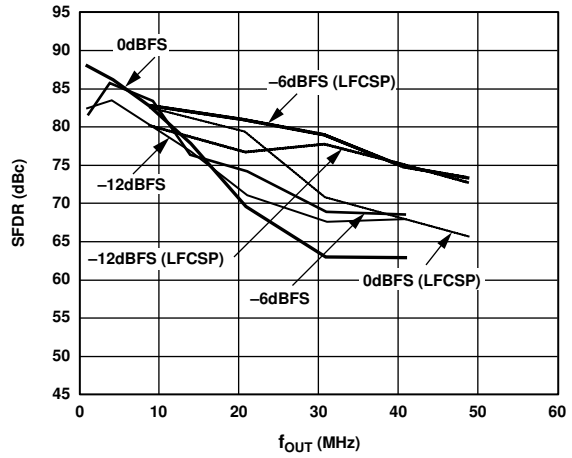

Figure 8. SFDR vs.  $f_{OUT}$  @ 165 MSPS

02912-B-007

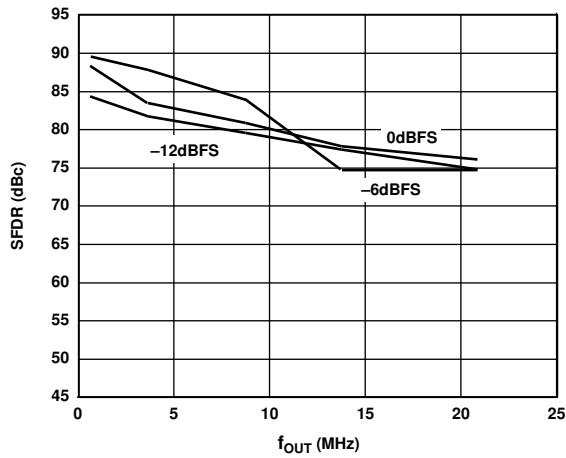

Figure 6. SFDR vs.  $f_{OUT}$  @ 65 MSPS

02912-B-009

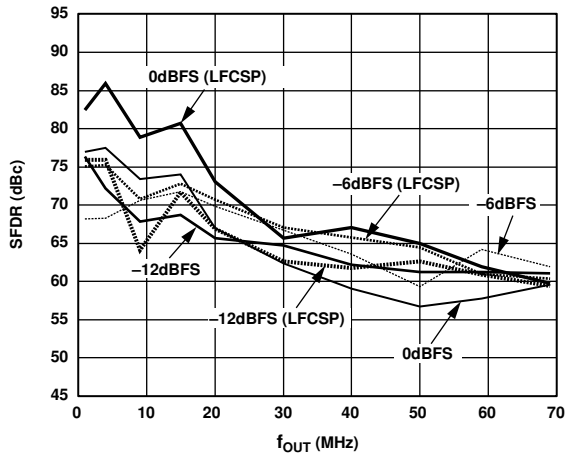

Figure 9. SFDR vs.  $f_{OUT}$  @ 210 MSPS

02912-B-054

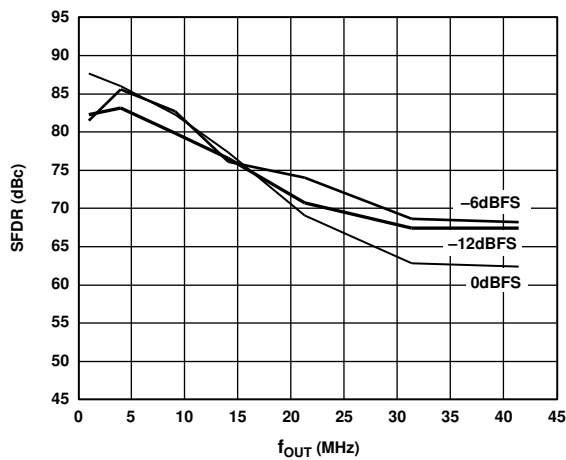

Figure 7. SFDR vs.  $f_{OUT}$  @ 125 MSPS

02912-B-012

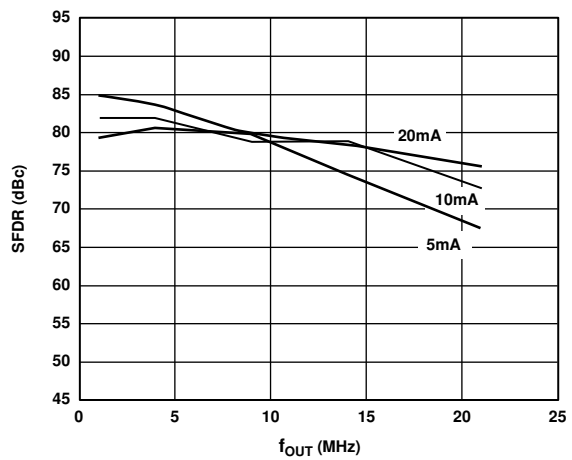

Figure 10. SFDR vs.  $f_{OUT}$  and  $I_{OUTS}$  @ 65 MSPS and 0 dBFS

02912-B-010

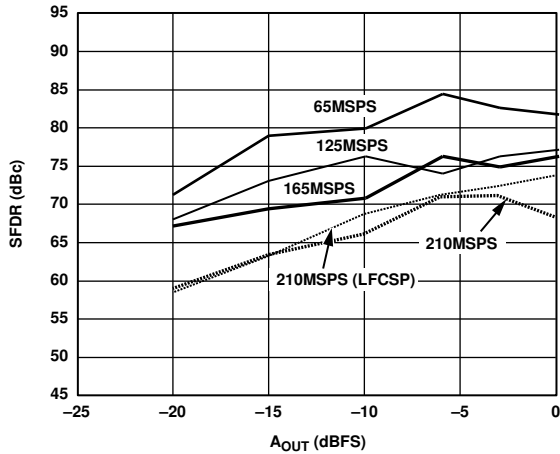

Figure 11. Single-Tone SFDR vs.  $A_{OUT}$  @  $f_{OUT} = f_{CLOCK}/11$

02912-B-013

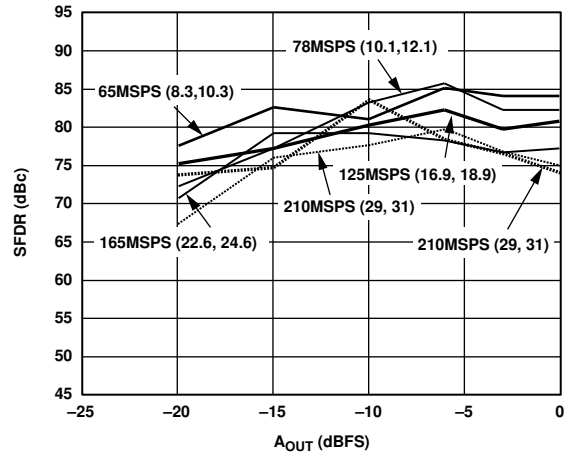

Figure 14. Dual-Tone IMD vs.  $A_{OUT}$  @  $f_{OUT} = f_{CLOCK}/7$

02912-B-014

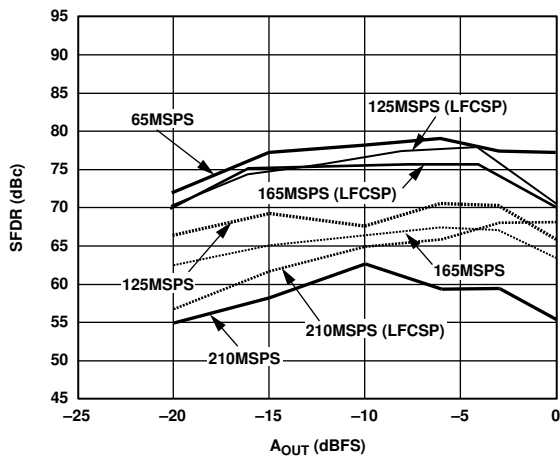

Figure 12. Single-Tone SFDR vs.  $A_{OUT}$  @  $f_{OUT} = f_{CLOCK}/5$

02912-B-008

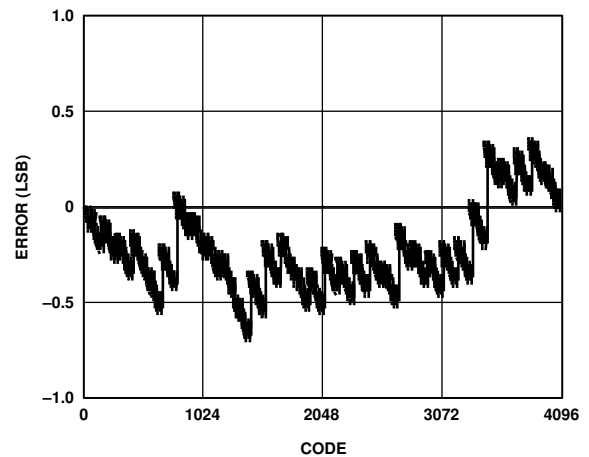

Figure 15. Typical INL

02912-B-015

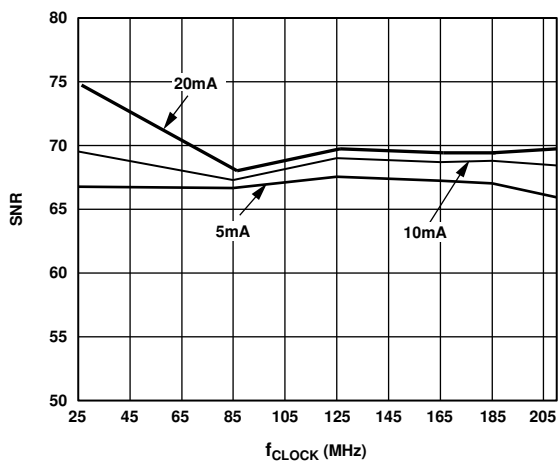

Figure 13. SNR vs.  $f_{CLOCK}$  and  $I_{OUTFS}$  @  $f_{OUT} = 5$  MHz and 0 dBFS

02912-B-011

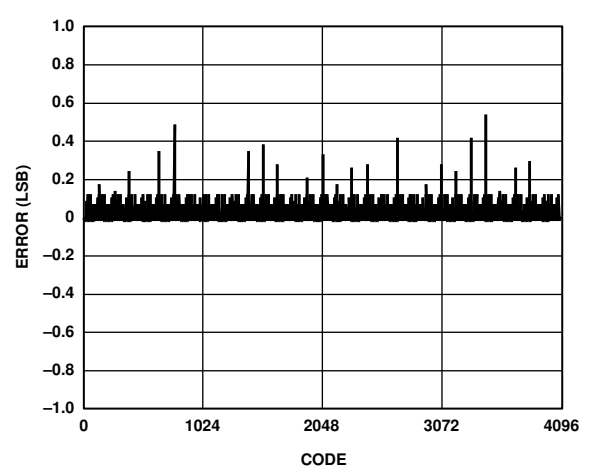

Figure 16. Typical DNL

02912-B-017

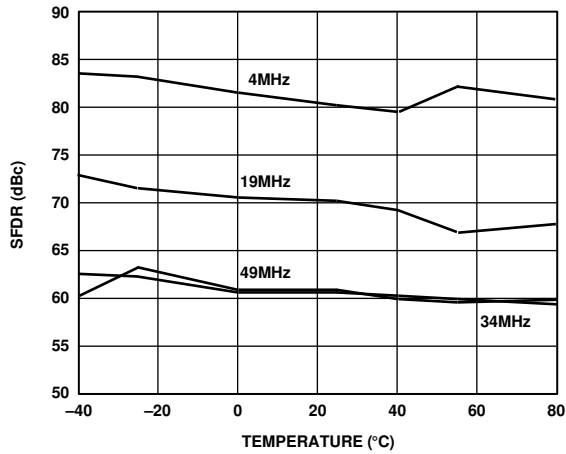

Figure 17. SFDR vs. Temperature @ 165 MSPS, 0 dBFS

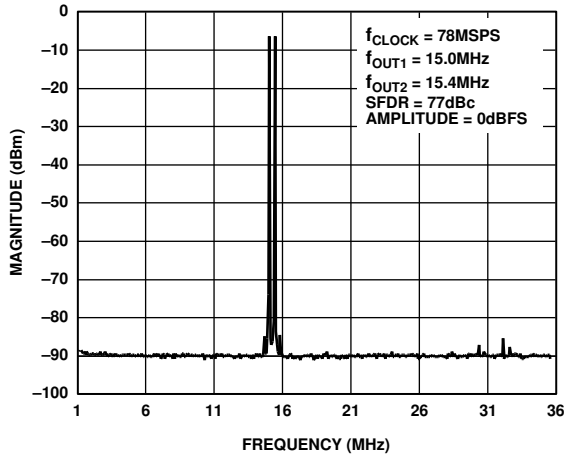

Figure 19. Dual-Tone SFDR

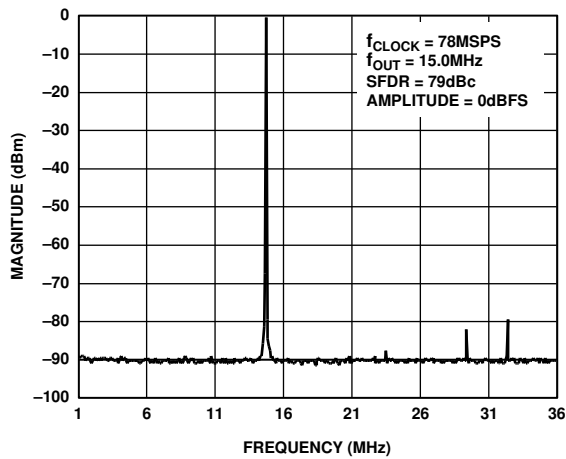

Figure 18. Single-Tone SFDR

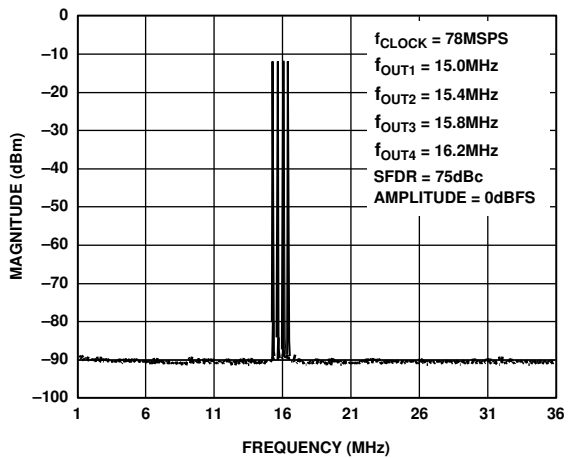

Figure 20. Four-Tone SFDR

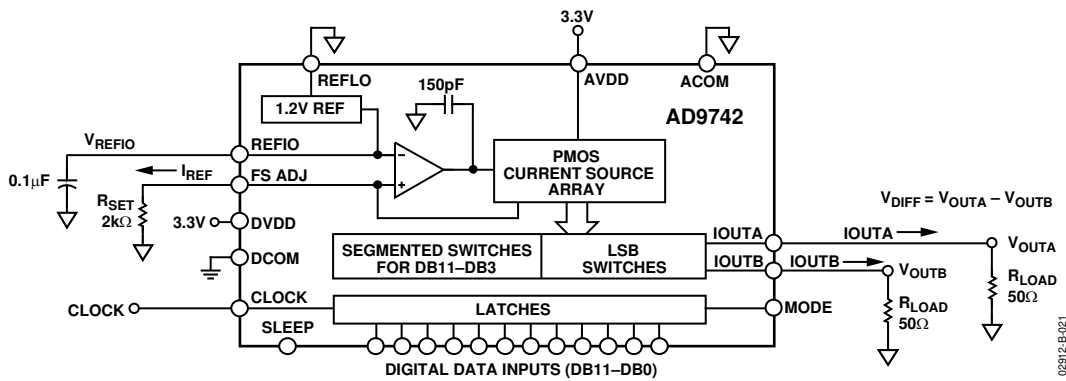

Figure 21. Simplified Block Diagram (SOIC/TSSOP Packages)



## FUNCTIONAL DESCRIPTION

AD9742 consists of a DAC, digital control logic, and full-scale output current control. The DAC contains a PMOS current source array capable of providing up to 20 mA of full-scale current ( $I_{OUTFS}$ ). The array is divided into 31 equal currents that make up the five most significant bits (MSBs). The next four bits, or middle bits, consist of 15 equal current sources whose value is 1/16th of an MSB current source. The remaining LSBs are binary weighted fractions of the middle bits current sources. Implementing the middle and lower bits with current sources, instead of an R-2R ladder, enhances its dynamic performance for multitone or low amplitude signals and helps maintain the DAC's high output impedance (i.e., >100 k $\Omega$ ).

All of these current sources are switched to one or the other of the two output nodes (i.e., IOUTA or IOUTB) via PMOS differential current switches. The switches are based on the architecture that was pioneered in the AD9764 family, with further refinements to reduce distortion contributed by the switching transient. This switch architecture also reduces various timing errors and provides matching complementary drive signals to the inputs of the differential current switches.

The analog and digital sections of the AD9742 have separate power supply inputs (i.e., AVDD and DVDD) that can operate independently over a 2.7 V to 3.6 V range. The digital section, which is capable of operating at a rate of up to 210 MSPS, consists of edge-triggered latches and segment decoding logic circuitry. The analog section includes the PMOS current sources, the associated differential switches, a 1.2 V band gap voltage reference, and a reference control amplifier.

The DAC full-scale output current is regulated by the reference control amplifier and can be set from 2 mA to 20 mA via an external resistor,  $R_{SET}$ , connected to the full-scale adjust (FS ADJ) pin. The external resistor, in combination with both the reference control amplifier and voltage reference,  $V_{REFIO}$ , sets the reference current,  $I_{REF}$ , which is replicated to the segmented current sources with the proper scaling factor. The full-scale current,  $I_{OUTFS}$ , is 32 times  $I_{REF}$ .

## REFERENCE OPERATION

The AD9742 contains an internal 1.2 V band gap reference. The internal reference can be disabled by raising REFLO to AVDD. It can also be easily overridden by an external reference with no effect on performance. REFIO serves as either an input or an output depending on whether the internal or an external reference is used. To use the internal reference, simply decouple the REFIO pin to ACOM with a 0.1  $\mu$ F capacitor and connect REFLO to ACOM via a resistance less than 5  $\Omega$ . The internal reference voltage will be present at REFIO. If the voltage at REFIO is to be used anywhere else in the circuit, an external buffer amplifier with an input bias current of less than 100 nA should be used. An example of the use of the internal reference is shown in Figure 23.

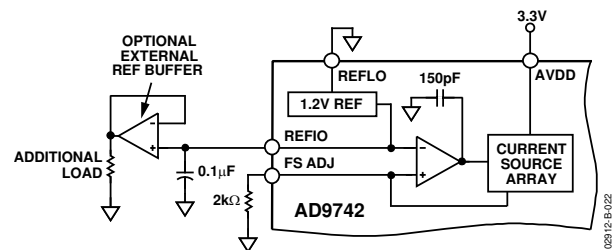

Figure 23. Internal Reference Configuration

An external reference can be applied to REFIO, as shown in Figure 24. The external reference may provide either a fixed reference voltage to enhance accuracy and drift performance or a varying reference voltage for gain control. Note that the 0.1  $\mu$ F compensation capacitor is not required since the internal reference is overridden, and the relatively high input impedance of REFIO minimizes any loading of the external reference.

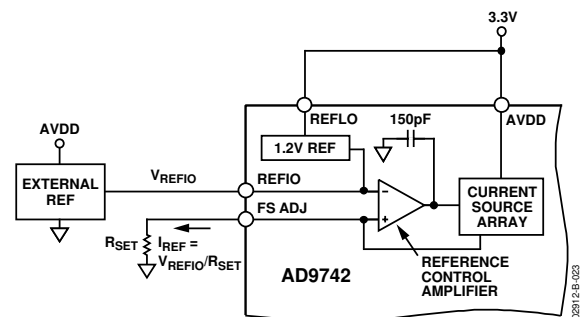

Figure 24. External Reference Configuration



## REFERENCE CONTROL AMPLIFIER

The AD9742 contains a control amplifier that is used to regulate the full-scale output current,  $I_{OUTFS}$ . The control amplifier is configured as a V-I converter, as shown in Figure 24, so that its current output,  $I_{REF}$ , is determined by the ratio of the  $V_{REFIO}$  and an external resistor,  $R_{SET}$ , as stated in Equation 4.  $I_{REF}$  is copied to the segmented current sources with the proper scale factor to set  $I_{OUTFS}$ , as stated in Equation 3.

The control amplifier allows a wide (10:1) adjustment span of  $I_{OUTFS}$  over a 2 mA to 20 mA range by setting  $I_{REF}$  between 62.5  $\mu$ A and 625  $\mu$ A. The wide adjustment span of  $I_{OUTFS}$  provides several benefits. The first relates directly to the power dissipation of the AD9742, which is proportional to  $I_{OUTFS}$  (see the Power Dissipation section). The second relates to the 20 dB adjustment, which is useful for system gain control purposes.

The small signal bandwidth of the reference control amplifier is approximately 500 kHz and can be used for low frequency small signal multiplying applications.

## DAC TRANSFER FUNCTION

Both DACs in the AD9742 provide complementary current outputs,  $I_{OUTA}$  and  $I_{OUTB}$ .  $I_{OUTA}$  provides a near full-scale current output,  $I_{OUTFS}$ , when all bits are high (i.e.,  $DAC\ CODE = 4095$ ), while  $I_{OUTB}$ , the complementary output, provides no current. The current output appearing at  $I_{OUTA}$  and  $I_{OUTB}$  is a function of both the input code and  $I_{OUTFS}$  and can be expressed as:

$$I_{OUTA} = (DAC\ CODE / 4096) \times I_{OUTFS} \quad (1)$$

$$I_{OUTB} = (4095 - DAC\ CODE) / 4096 \times I_{OUTFS} \quad (2)$$

where  $DAC\ CODE = 0$  to 4095 (i.e., decimal representation).

As mentioned previously,  $I_{OUTFS}$  is a function of the reference current  $I_{REF}$ , which is nominally set by a reference voltage,  $V_{REFIO}$ , and external resistor,  $R_{SET}$ . It can be expressed as:

$$I_{OUTFS} = 32 \times I_{REF} \quad (3)$$

where

$$I_{REF} = V_{REFIO} / R_{SET} \quad (4)$$

The two current outputs will typically drive a resistive load directly or via a transformer. If dc coupling is required,  $I_{OUTA}$  and  $I_{OUTB}$  should be directly connected to matching resistive loads,  $R_{LOAD}$ , that are tied to analog common, ACOM. Note that  $R_{LOAD}$  may represent the equivalent load resistance seen by  $I_{OUTA}$  or  $I_{OUTB}$  as would be the case in a doubly terminated 50  $\Omega$  or 75  $\Omega$  cable. The single-ended voltage output appearing at the  $I_{OUTA}$  and  $I_{OUTB}$  nodes is simply

$$V_{OUTA} = I_{OUTA} \times R_{LOAD} \quad (5)$$

$$V_{OUTB} = I_{OUTB} \times R_{LOAD} \quad (6)$$

Note that the full-scale value of  $V_{OUTA}$  and  $V_{OUTB}$  should not exceed the specified output compliance range to maintain specified distortion and linearity performance.

$$V_{DIFF} = (I_{OUTA} - I_{OUTB}) \times R_{LOAD} \quad (7)$$

Substituting the values of  $I_{OUTA}$ ,  $I_{OUTB}$ ,  $I_{REF}$ , and  $V_{DIFF}$  can be expressed as:

$$V_{DIFF} = \left\{ (2 \times DAC\ CODE - 4095) / 4096 \right\} \left( 32 \times R_{LOAD} / R_{SET} \right) \times V_{REFIO} \quad (8)$$

Equations 7 and 8 highlight some of the advantages of operating the AD9742 differentially. First, the differential operation helps cancel common-mode error sources associated with  $I_{OUTA}$  and  $I_{OUTB}$ , such as noise, distortion, and dc offsets. Second, the differential code-dependent current and subsequent voltage,  $V_{DIFF}$ , is twice the value of the single-ended voltage output (i.e.,  $V_{OUTA}$  or  $V_{OUTB}$ ), thus providing twice the signal power to the load.

Note that the gain drift temperature performance for a single-ended ( $V_{OUTA}$  and  $V_{OUTB}$ ) or differential output ( $V_{DIFF}$ ) of the AD9742 can be enhanced by selecting temperature tracking resistors for  $R_{LOAD}$  and  $R_{SET}$  due to their ratiometric relationship, as shown in Equation 8.

## ANALOG OUTPUTS

The complementary current outputs in each DAC,  $I_{OUTA}$ , and  $I_{OUTB}$  may be configured for single-ended or differential operation.  $I_{OUTA}$  and  $I_{OUTB}$  can be converted into complementary single-ended voltage outputs,  $V_{OUTA}$  and  $V_{OUTB}$ , via a load resistor,  $R_{LOAD}$ , as described in the DAC Transfer Function section by Equations 5 through 8. The differential voltage,  $V_{DIFF}$ , existing between  $V_{OUTA}$  and  $V_{OUTB}$ , can also be converted to a single-ended voltage via a transformer or differential amplifier configuration. The ac performance of the AD9742 is optimum and specified using a differential transformer-coupled output in which the voltage swing at  $I_{OUTA}$  and  $I_{OUTB}$  is limited to  $\pm 0.5$  V.

The distortion and noise performance of the AD9742 can be enhanced when it is configured for differential operation. The common-mode error sources of both  $I_{OUTA}$  and  $I_{OUTB}$  can be significantly reduced by the common-mode rejection of a transformer or differential amplifier. These common-mode error sources include even-order distortion products and noise. The enhancement in distortion performance becomes more significant as the frequency content of the reconstructed waveform increases and/or its amplitude decreases. This is due to the first-order cancellation of various dynamic common-mode distortion mechanisms, digital feedthrough, and noise.

Performing a differential-to-single-ended conversion via a transformer also provides the ability to deliver twice the reconstructed signal power to the load (assuming no source termination). Since the output currents of  $I_{OUTA}$  and  $I_{OUTB}$  are complementary, they become additive when processed differentially. A properly selected transformer will allow the AD9742 to provide the required power and voltage levels to different loads.

The output impedance of IOUTA and IOUTB is determined by the equivalent parallel combination of the PMOS switches associated with the current sources and is typically 100 k $\Omega$  in parallel with 5 pF. It is also slightly dependent on the output voltage (i.e.,  $V_{OUTA}$  and  $V_{OUTB}$ ) due to the nature of a PMOS device. As a result, maintaining IOUTA and/or IOUTB at a virtual ground via an I-V op amp configuration will result in the optimum dc linearity. Note that the INL/DNL specifications for the AD9742 are measured with IOUTA maintained at a virtual ground via an op amp.

IOUTA and IOUTB also have a negative and positive voltage compliance range that must be adhered to in order to achieve optimum performance. The negative output compliance range of  $-1$  V is set by the breakdown limits of the CMOS process. Operation beyond this maximum limit may result in a breakdown of the output stage and affect the reliability of the AD9742.

The positive output compliance range is slightly dependent on the full-scale output current,  $I_{OUTFS}$ . It degrades slightly from its nominal 1.2 V for an  $I_{OUTFS} = 20$  mA to 1 V for an  $I_{OUTFS} = 2$  mA. The optimum distortion performance for a single-ended or differential output is achieved when the maximum full-scale signal at IOUTA and IOUTB does not exceed 0.5 V.

## DIGITAL INPUTS

The AD9742 digital section consists of 12 input bit channels and a clock input. The 12-bit parallel data inputs follow standard positive binary coding, where DB11 is the most significant bit (MSB) and DB0 is the least significant bit (LSB). IOUTA produces a full-scale output current when all data bits are at Logic 1. IOUTB produces a complementary output with the full-scale current split between the two outputs as a function of the input code.

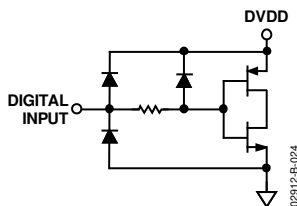

Figure 25. Equivalent Digital Input

The digital interface is implemented using an edge-triggered master/slave latch. The DAC output updates on the rising edge of the clock and is designed to support a clock rate as high as 210 MSPS. The clock can be operated at any duty cycle that meets the specified latch pulse width. The setup and hold times can also be varied within the clock cycle as long as the specified minimum times are met, although the location of these transition edges may affect digital feedthrough and distortion performance. Best performance is typically achieved when the input data transitions on the falling edge of a 50% duty cycle clock.

## CLOCK INPUT

### SOIC/TSSOP Packages

The 28-lead package options have a single-ended clock input (CLOCK) that must be driven to rail-to-rail CMOS levels. The quality of the DAC output is directly related to the clock quality, and jitter is a key concern. Any noise or jitter in the clock will translate directly into the DAC output. Optimal performance will be achieved if the CLOCK input has a sharp rising edge, since the DAC latches are positive edge triggered.

### LFCSP Package

A configurable clock input is available in the LFCSP package, which allows for one single-ended and two differential modes. The mode selection is controlled by the CMODE input, as summarized in Table 7. Connecting CMODE to CLKCOM selects the single-ended clock input. In this mode, the CLK+ input is driven with rail-to-rail swings and the CLK- input is left floating. If CMODE is connected to CLKVDD, the differential receiver mode is selected. In this mode, both inputs are high impedance. The final mode is selected by floating CMODE. This mode is also differential, but internal terminations for positive emitter-coupled logic (PECL) are activated. There is no significant performance difference between any of the three clock input modes.

Table 7. Clock Mode Selection

CMODE Pin	Clock Input Mode
CLKCOM	Single-Ended
CLKVDD	Differential
Float	PECL

The single-ended input mode operates in the same way as the CLOCK input in the 28-lead packages, as described previously.

In the differential input mode, the clock input functions as a high impedance differential pair. The common-mode level of the CLK+ and CLK- inputs can vary from 0.75 V to 2.25 V, and the differential voltage can be as low as 0.5 V p-p. This mode can be used to drive the clock with a differential sine wave since the high gain bandwidth of the differential inputs will convert the sine wave into a single-ended square wave internally.

The final clock mode allows for a reduced external component count when the DAC clock is distributed on the board using PECL logic. The internal termination configuration is shown in Figure 26. These termination resistors are untrimmed and can vary up to  $\pm 20\%$ . However, matching between the resistors should generally be better than  $\pm 1\%$ .

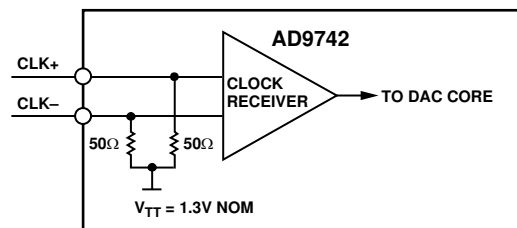

Figure 26. Clock Termination in PECL Mode

**DAC TIMING**

**Input Clock and Data Timing Relationship**

Dynamic performance in a DAC is dependent on the relationship between the position of the clock edges and the time at which the input data changes. The AD9742 is rising edge triggered, and so exhibits dynamic performance sensitivity when the data transition is close to this edge. In general, the goal when applying the AD9742 is to make the data transition close to the falling clock edge. This becomes more important as the sample rate increases. Figure 27 shows the relationship of SFDR to clock placement with different sample rates. Note that at the lower sample rates, more tolerance is allowed in clock placement, while at higher rates, more care must be taken.

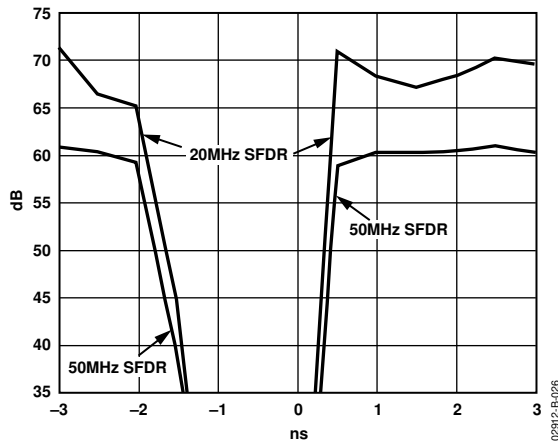

Figure 27. SFDR vs. Clock Placement @  $f_{OUT} = 20\text{ MHz}$  and  $50\text{ MHz}$

**Sleep Mode Operation**

The AD9742 has a power-down function that turns off the output current and reduces the supply current to less than 6 mA over the specified supply range of 2.7 V to 3.6 V and temperature range. This mode can be activated by applying a Logic Level 1 to the SLEEP pin. The SLEEP pin logic threshold is equal to 0.5  $\Omega$  AVDD. This digital input also contains an active pull-down circuit that ensures that the AD9742 remains enabled if this input is left disconnected. The AD9742 takes less than 50 ns to power down and approximately 5  $\mu$ s to power back up.

**POWER DISSIPATION**

The power dissipation,  $P_D$ , of the AD9742 is dependent on several factors that include:

- The power supply voltages (AVDD, CLKVDD, and DVDD)
- The full-scale current output  $I_{OUTFS}$
- The update rate  $f_{CLOCK}$
- The reconstructed digital input waveform

The power dissipation is directly proportional to the analog supply current,  $I_{AVDD}$ , and the digital supply current,  $I_{DVDD}$ .  $I_{AVDD}$  is directly proportional to  $I_{OUTFS}$ , as shown in Figure 28, and is insensitive to  $f_{CLOCK}$ . Conversely,  $I_{DVDD}$  is dependent on both the digital input waveform,  $f_{CLOCK}$ , and digital supply DVDD. Figure 29 shows  $I_{DVDD}$  as a function of full-scale sine wave output ratios ( $f_{OUT}/f_{CLOCK}$ ) for various update rates with DVDD = 3.3 V.

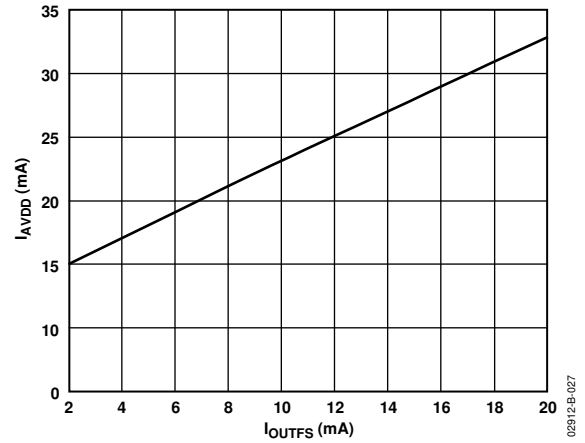

Figure 28.  $I_{AVDD}$  vs.  $I_{OUTFS}$

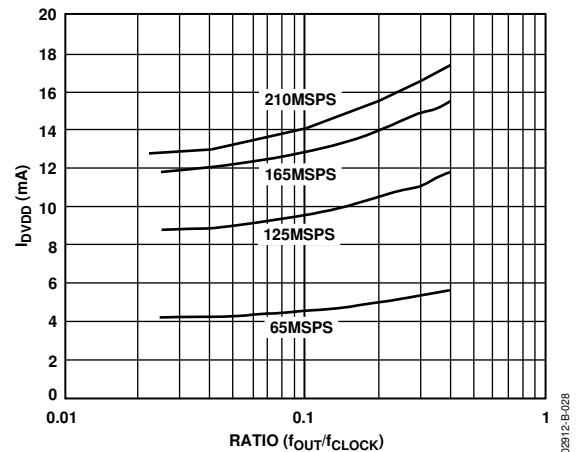

Figure 29.  $I_{DVDD}$  vs. Ratio @ DVDD = 3.3 V

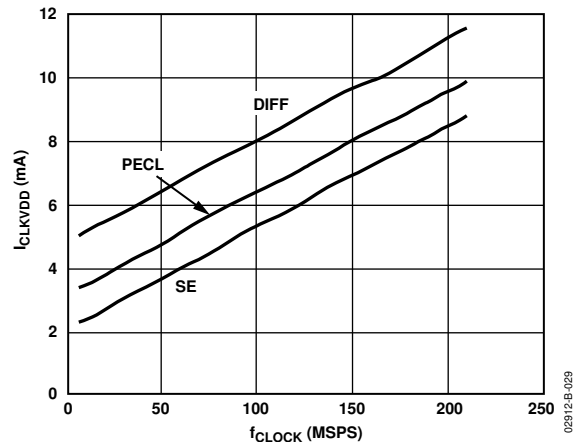

Figure 30.  $I_{CLKVDD}$  vs.  $f_{CLOCK}$  and Clock Mode

## APPLYING THE AD9742

### Output Configurations

The following sections illustrate some typical output configurations for the AD9742. Unless otherwise noted, it is assumed that  $I_{OUTFS}$  is set to a nominal 20 mA. For applications requiring the optimum dynamic performance, a differential output configuration is suggested. A differential output configuration may consist of either an RF transformer or a differential op amp configuration. The transformer configuration provides optimum high frequency performance and is recommended for any application that allows ac coupling. The differential op amp configuration is suitable for applications requiring dc coupling, a bipolar output, signal gain, and/or level shifting within the bandwidth of the chosen op amp.

A single-ended output is suitable for applications requiring a unipolar voltage output. A positive unipolar output voltage will result if  $I_{OUTA}$  and/or  $I_{OUTB}$  are connected to an appropriately sized load resistor,  $R_{LOAD}$ , referred to ACOM. This configuration may be more suitable for a single-supply system requiring a dc-coupled, ground-referred output voltage. Alternatively, an amplifier could be configured as an I-V converter, thus converting  $I_{OUTA}$  or  $I_{OUTB}$  into a negative unipolar voltage. This configuration provides the best dc linearity since  $I_{OUTA}$  or  $I_{OUTB}$  is maintained at a virtual ground.

### DIFFERENTIAL COUPLING USING A TRANSFORMER

An RF transformer can be used to perform a differential-to-single-ended signal conversion, as shown in Figure 31. A differentially coupled transformer output provides the optimum distortion performance for output signals whose spectral content lies within the transformer's pass band. An RF transformer, such as the Mini-Circuits T1-1T, provides excellent rejection of common-mode distortion (that is, even-order harmonics) and noise over a wide frequency range. It also provides electrical isolation and the ability to deliver twice the power to the load. Transformers with different impedance ratios may also be used for impedance matching purposes. Note that the transformer provides ac coupling only.

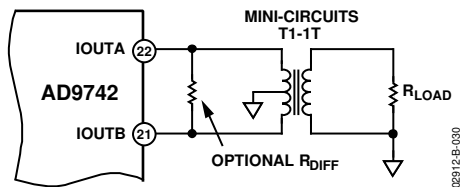

Figure 31. Differential Output Using a Transformer

The center tap on the primary side of the transformer must be connected to ACOM to provide the necessary dc current path for both  $I_{OUTA}$  and  $I_{OUTB}$ . The complementary voltages appearing at  $I_{OUTA}$  and  $I_{OUTB}$  (i.e.,  $V_{OUTA}$  and  $V_{OUTB}$ ) swing symmetrically around ACOM and should be maintained with the specified output compliance range of the AD9742. A differential resistor,  $R_{DIFF}$ , may be inserted in applications where the output of the transformer is connected to the load,  $R_{LOAD}$ , via a passive reconstruction filter or cable.  $R_{DIFF}$  is determined by the transformer's impedance ratio and provides the proper source

termination that results in a low VSWR. Note that approximately half the signal power will be dissipated across  $R_{DIFF}$ .

### DIFFERENTIAL COUPLING USING AN OP AMP

An op amp can also be used to perform a differential-to-single-ended conversion, as shown in Figure 32. The AD9742 is configured with two equal load resistors,  $R_{LOAD}$ , of 25  $\Omega$ . The differential voltage developed across  $I_{OUTA}$  and  $I_{OUTB}$  is converted to a single-ended signal via the differential op amp configuration. An optional capacitor can be installed across  $I_{OUTA}$  and  $I_{OUTB}$ , forming a real pole in a low-pass filter. The addition of this capacitor also enhances the op amp's distortion performance by preventing the DAC's high slewing output from overloading the op amp's input.

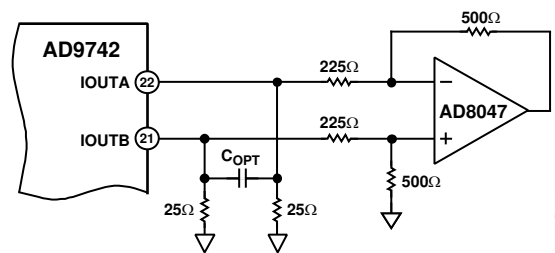

Figure 32. DC Differential Coupling Using an Op Amp

The common-mode rejection of this configuration is typically determined by the resistor matching. In this circuit, the differential op amp circuit using the AD8047 is configured to provide some additional signal gain. The op amp must operate off a dual supply since its output is approximately  $\pm 1$  V. A high speed amplifier capable of preserving the differential performance of the AD9742 while meeting other system level objectives (e.g., cost or power) should be selected. The op amp's differential gain, gain setting resistor values, and full-scale output swing capabilities should all be considered when optimizing this circuit.

The differential circuit shown in Figure 33 provides the necessary level shifting required in a single-supply system. In this case,  $AV_{DD}$ , which is the positive analog supply for both the AD9742 and the op amp, is also used to level shift the differential output of the AD9742 to midsupply (i.e.,  $AV_{DD}/2$ ). The AD8041 is a suitable op amp for this application.

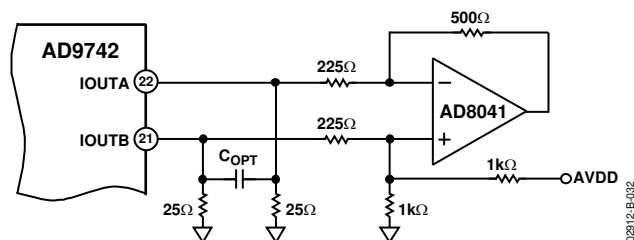

Figure 33. Single-Supply DC Differential Coupled Circuit

### SINGLE-ENDED, UNBUFFERED VOLTAGE OUTPUT

Figure 34 shows the AD9742 configured to provide a unipolar output range of approximately 0 V to 0.5 V for a doubly terminated 50 Ω cable since the nominal full-scale current,  $I_{OUTFS}$ , of 20 mA flows through the equivalent  $R_{LOAD}$  of 25 Ω. In this case,  $R_{LOAD}$  represents the equivalent load resistance seen by  $I_{OUTA}$  or  $I_{OUTB}$ . The unused output ( $I_{OUTA}$  or  $I_{OUTB}$ ) can be connected to ACOM directly or via a matching  $R_{LOAD}$ . Different values of  $I_{OUTFS}$  and  $R_{LOAD}$  can be selected as long as the positive compliance range is adhered to. One additional consideration in this mode is the integral nonlinearity (INL), discussed in the Analog Outputs section. For optimum INL performance, the single-ended, buffered voltage output configuration is suggested.

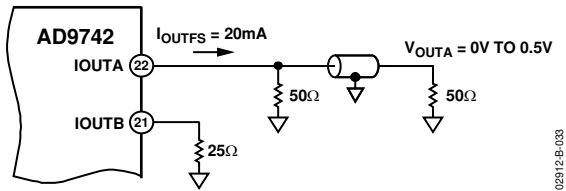

Figure 34. 0 V to 0.5 V Unbuffered Voltage Output

### SINGLE-ENDED, BUFFERED VOLTAGE OUTPUT CONFIGURATION

Figure 35 shows a buffered single-ended output configuration in which the op amp U1 performs an I-V conversion on the AD9742 output current. U1 maintains  $I_{OUTA}$  (or  $I_{OUTB}$ ) at a virtual ground, minimizing the nonlinear output impedance effect on the DAC's INL performance as described in the Analog Outputs section. Although this single-ended configuration typically provides the best dc linearity performance, its ac distortion performance at higher DAC update rates may be limited by U1's slew rate capabilities. U1 provides a negative unipolar output voltage, and its full-scale output voltage is simply the product of  $R_{FB}$  and  $I_{OUTFS}$ . The full-scale output should be set within U1's voltage output swing capabilities by scaling  $I_{OUTFS}$  and/or  $R_{FB}$ . An improvement in ac distortion performance may result with a reduced  $I_{OUTFS}$  since U1 will be required to sink less signal current.

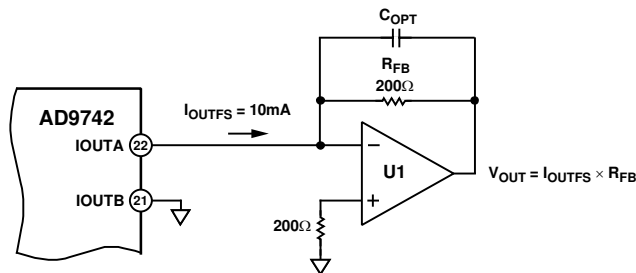

Figure 35. Unipolar Buffered Voltage Output

### POWER AND GROUNDING CONSIDERATIONS, POWER SUPPLY REJECTION

Many applications seek high speed and high performance under less than ideal operating conditions. In these application circuits, the implementation and construction of the printed circuit board is as important as the circuit design. Proper RF techniques must be used for device selection, placement, and routing as well as power supply bypassing and grounding to ensure optimum performance. Figure 40 to Figure 43 illustrate the recommended printed circuit board ground, power, and signal plane layouts implemented on the AD9742 evaluation board.

One factor that can measurably affect system performance is the ability of the DAC output to reject dc variations or ac noise superimposed on the analog or digital dc power distribution. This is referred to as the power supply rejection ratio (PSRR). For dc variations of the power supply, the resulting performance of the DAC directly corresponds to a gain error associated with the DAC's full-scale current,  $I_{OUTFS}$ . AC noise on the dc supplies is common in applications where the power distribution is generated by a switching power supply. Typically, switching power supply noise will occur over the spectrum from tens of kHz to several MHz. The PSRR versus frequency of the AD9742 AVDD supply over this frequency range is shown in Figure 36.

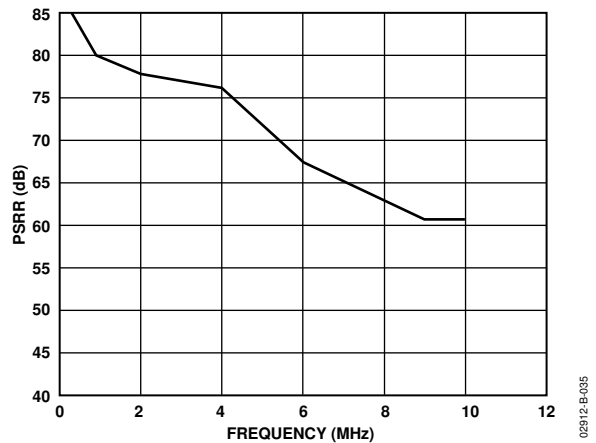

Figure 36. Power Supply Rejection Ratio (PSRR)

Note that the ratio in Figure 36 is calculated as amps out/volts in. Noise on the analog power supply has the effect of modulating the internal switches, and therefore the output current. The voltage noise on AVDD, therefore, will be added in a nonlinear manner to the desired  $I_{OUT}$ . Due to the relative different size of these switches, the PSRR is very code dependent. This can produce a mixing effect that can modulate low frequency power supply noise to higher frequencies. Worst-case PSRR for either one of the differential DAC outputs will occur when the full-scale current is directed toward that output. As a result, the PSRR measurement in Figure 36 represents a worst-case condition in which the digital inputs remain static and the full-scale output current of 20 mA is directed to the DAC output being measured.

An example serves to illustrate the effect of supply noise on the analog supply. Suppose a switching regulator with a switching frequency of 250 kHz produces 10 mV of noise and, for simplicity's sake (ignoring harmonics), all of this noise is concentrated at 250 kHz. To calculate how much of this undesired noise will appear as current noise superimposed on the DAC's full-scale current,  $I_{OUTFS}$ , one must determine the PSRR in dB using Figure 36 at 250 kHz. To calculate the PSRR for a given  $R_{LOAD}$ , such that the units of PSRR are converted from A/V to V/V, adjust the curve in Figure 36 by the scaling factor  $20 \Omega \log (R_{LOAD})$ . For instance, if  $R_{LOAD}$  is 50  $\Omega$ , the PSRR is reduced by 34 dB (i.e., PSRR of the DAC at 250 kHz, which is 85 dB in Figure 36, becomes 51 dB  $V_{OUT}/V_{IN}$ ).

Proper grounding and decoupling should be a primary objective in any high speed, high resolution system. The AD9742 features separate analog and digital supplies and ground pins to optimize the management of analog and digital ground currents in a system. In general, AVDD, the analog supply, should be decoupled to ACOM, the analog common, as close to the chip as physically

possible. Similarly, DVDD, the digital supply, should be decoupled to DCOM as close to the chip as physically possible.

For those applications that require a single 3.3 V supply for both the analog and digital supplies, a clean analog supply may be generated using the circuit shown in Figure 37. The circuit consists of a differential LC filter with separate power supply and return lines. Lower noise can be attained by using low ESR type electrolytic and tantalum capacitors.

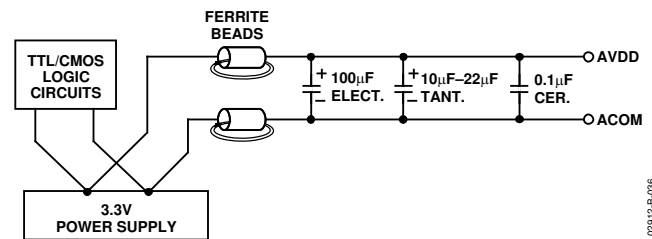

Figure 37. Differential LC Filter for Single 3.3 V Applications

02812-B-036



# EVALUATION BOARD

## GENERAL DESCRIPTION

The TxDAC family evaluation boards allow for easy setup and testing of any TxDAC product in the SOIC and LFCSP packages. Careful attention to layout and circuit design, combined with a prototyping area, allows the user to evaluate the AD9742 easily and effectively in any application where high resolution, high speed conversion is required.

This board allows the user the flexibility to operate the AD9742 in various configurations. Possible output configurations include transformer coupled, resistor terminated, and single and differential outputs. The digital inputs are designed to be driven from various word generators, with the on-board option to add a resistor network for proper load termination. Provisions are also made to operate the AD9742 with either the internal or external reference or to exercise the power-down feature.

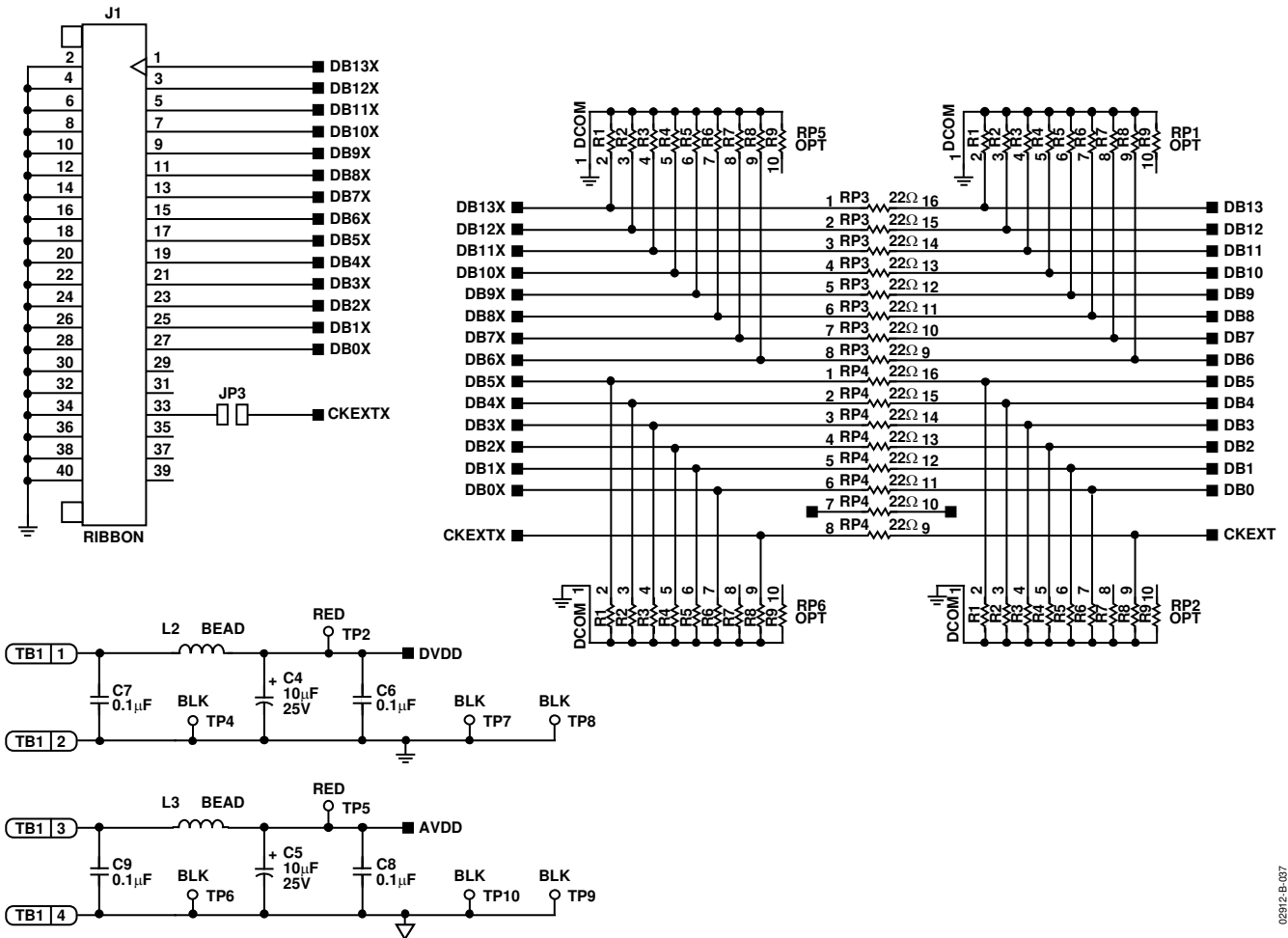

Figure 38. SOIC Evaluation Board—Power Supply and Digital Inputs

02812-B-037

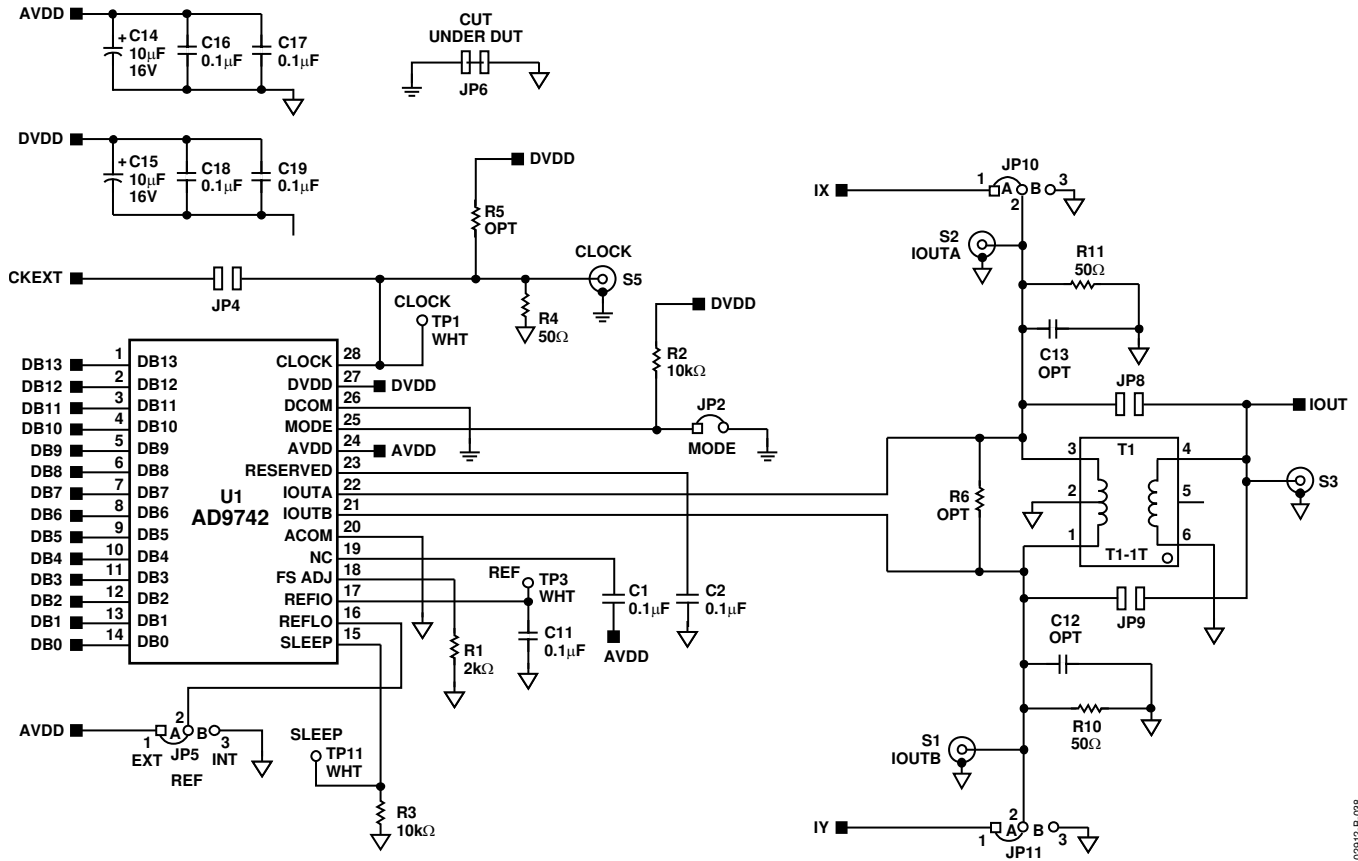

Figure 39. SOIC Evaluation Board—Output Signal Conditioning

029112-B-008

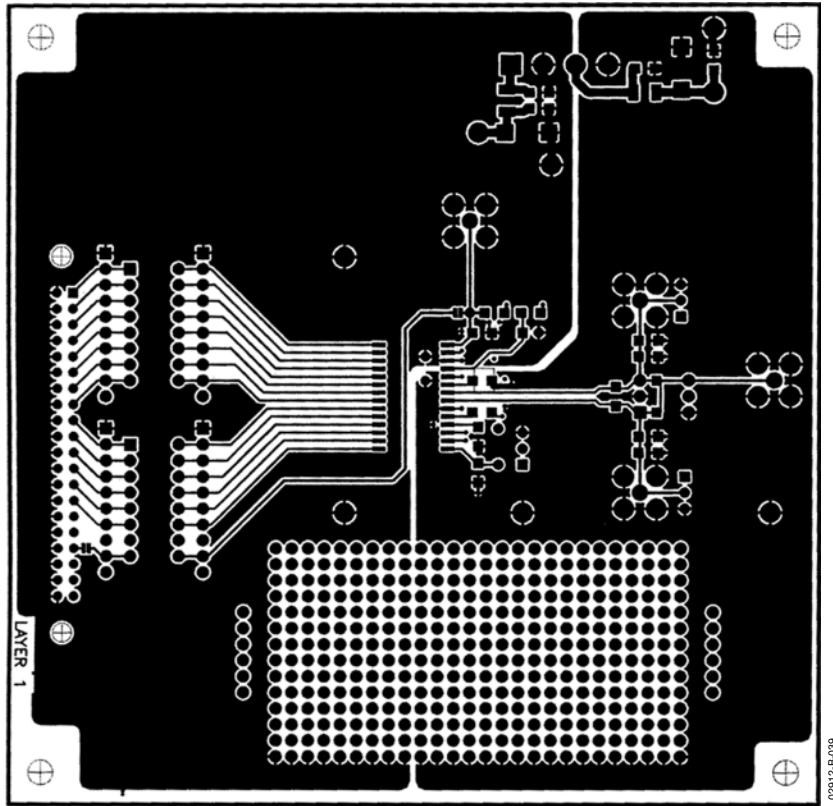

Figure 40. SOIC Evaluation Board—Primary Side

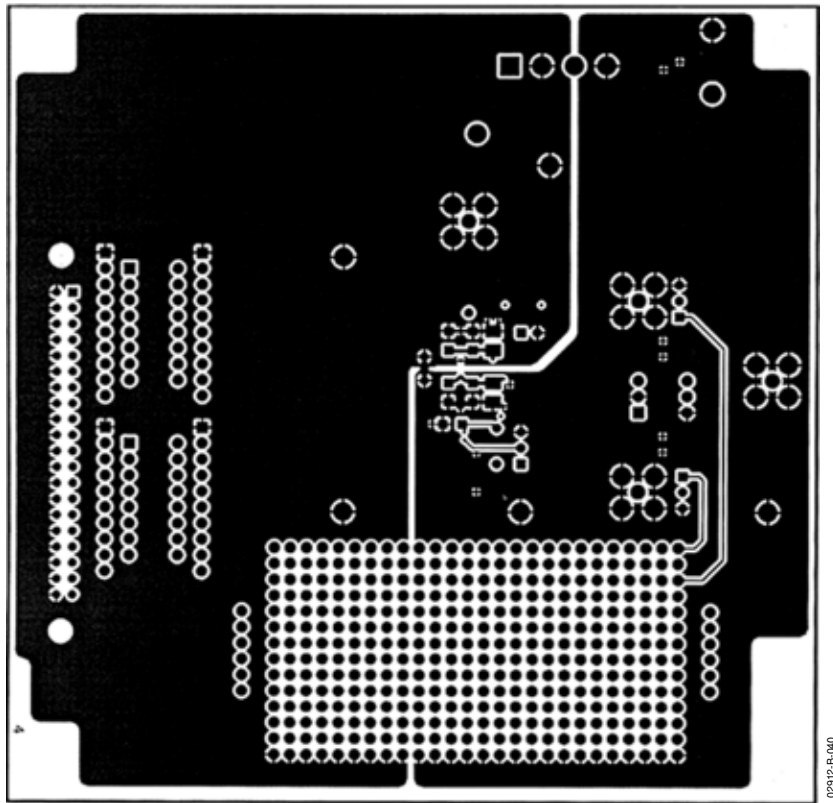

Figure 41. SOIC Evaluation Board—Secondary Side

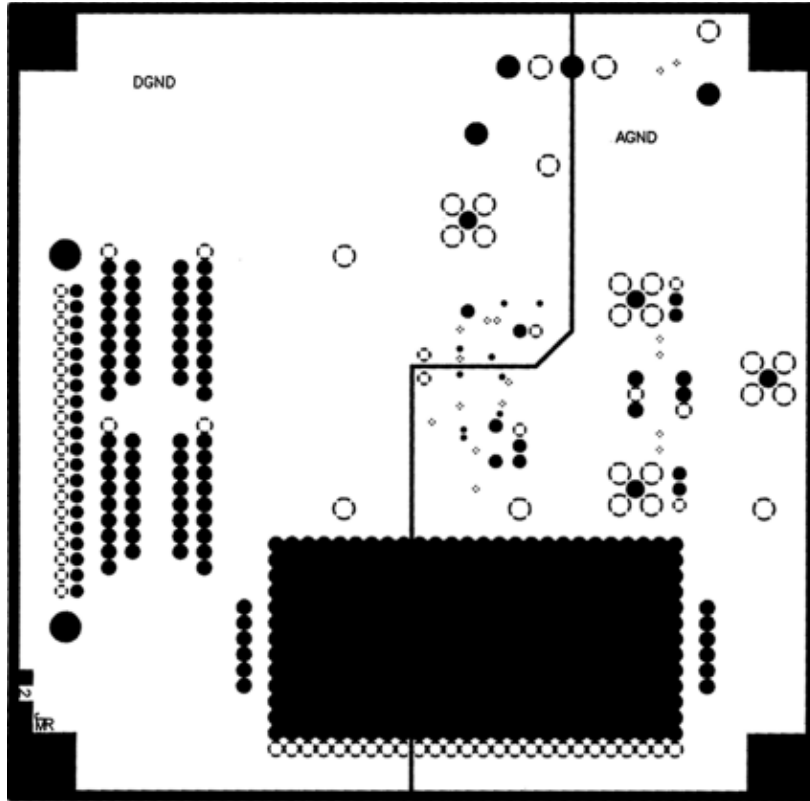

Figure 42. SOIC Evaluation Board—Ground Plane

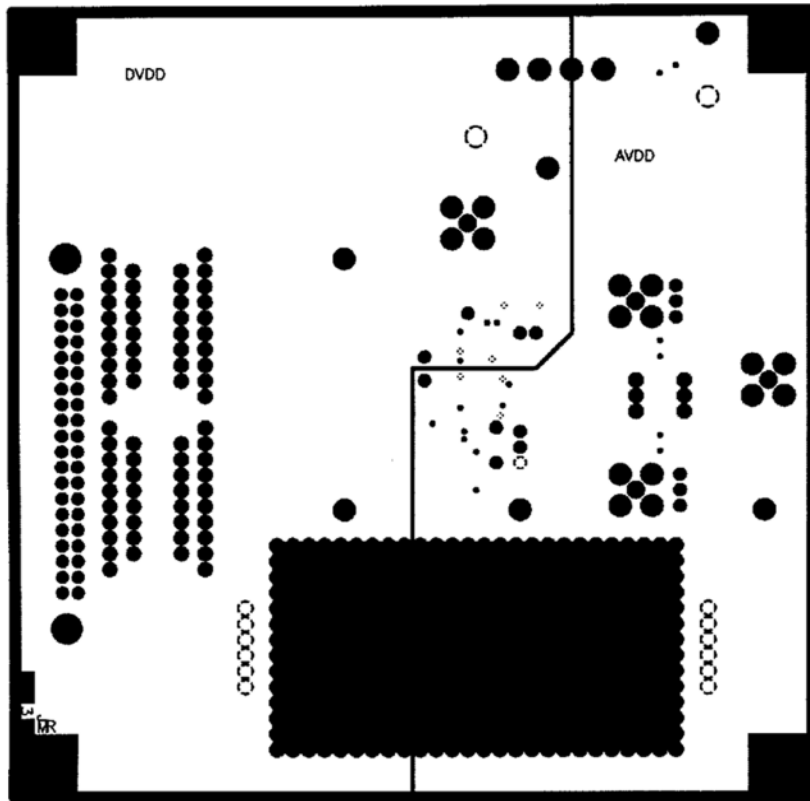

Figure 43. SOIC Evaluation Board—Power Plane

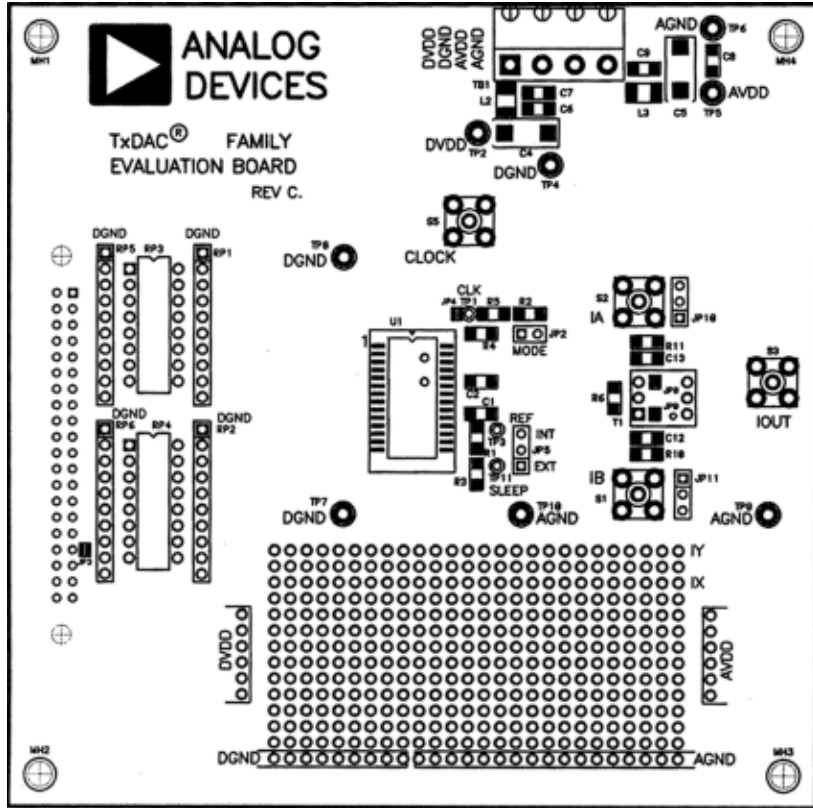

Figure 44. SOIC Evaluation Board Assembly—Primary Side

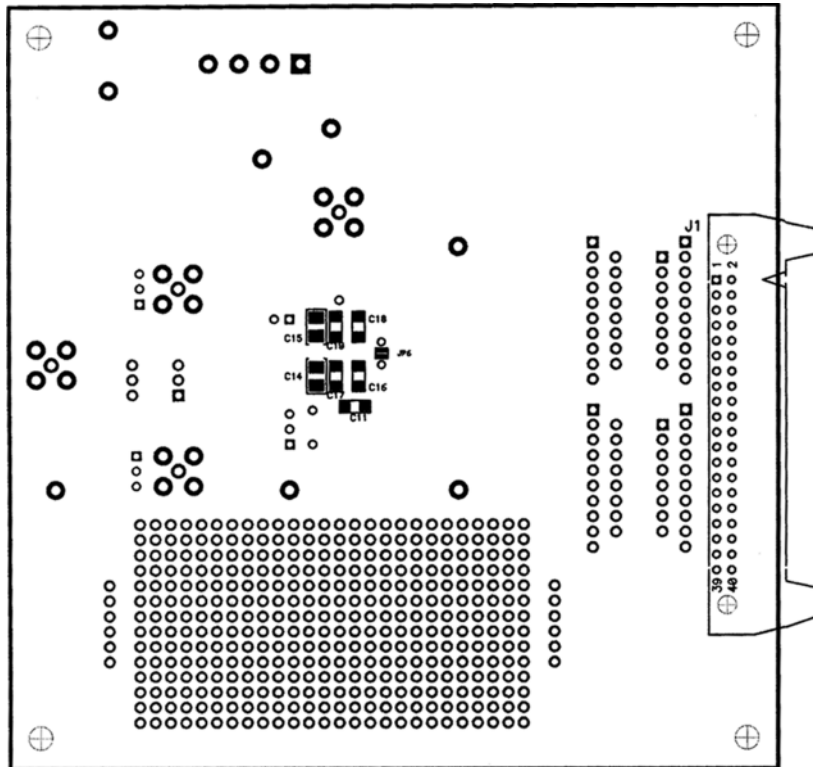

Figure 45. SOIC Evaluation Board Assembly—Secondary Side

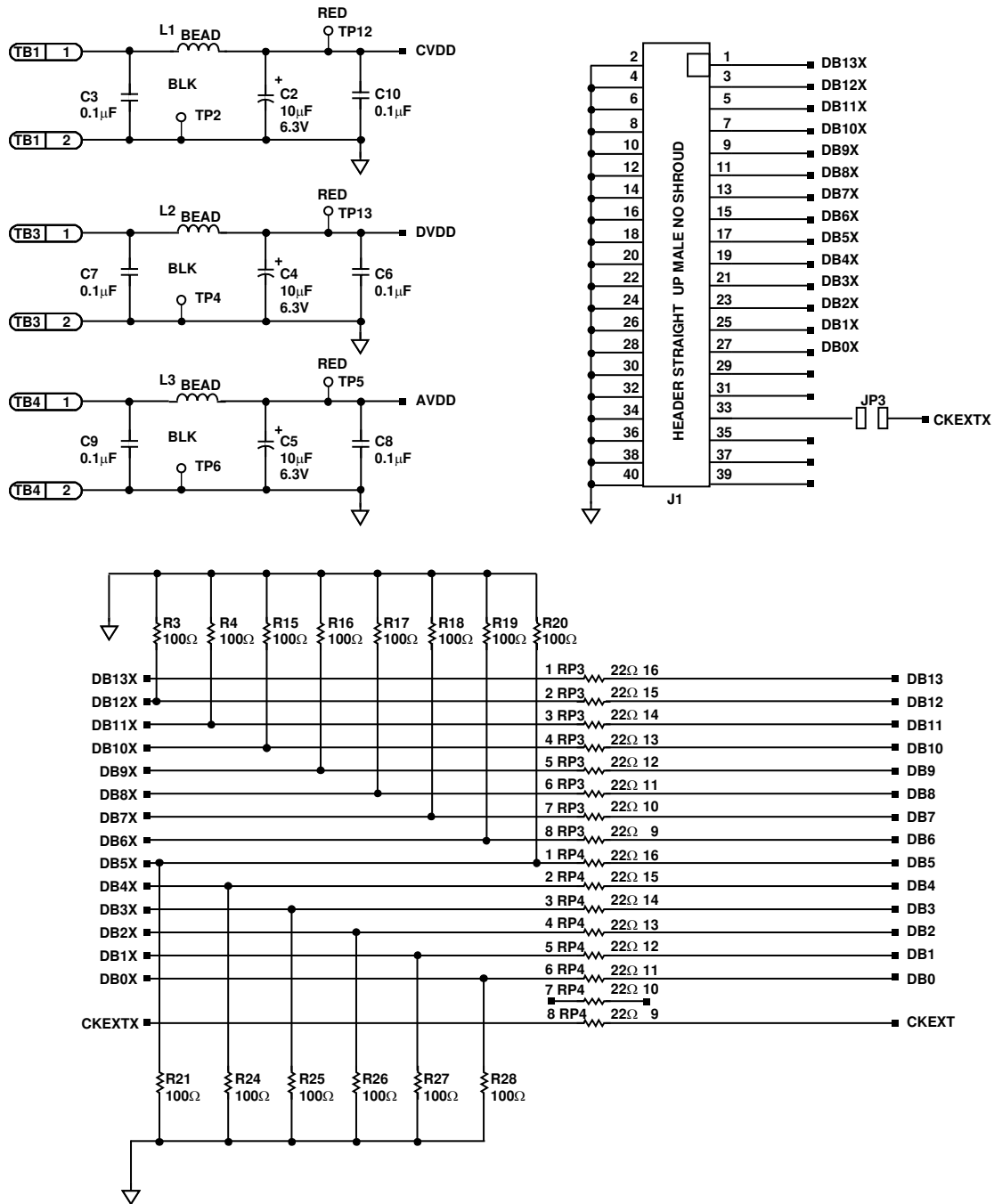

Figure 46. LFCSP Evaluation Board Schematic—Power Supply and Digital Inputs

02912.B-045