



Chipsmall Limited consists of a professional team with an average of over 10 year of expertise in the distribution of electronic components. Based in Hongkong, we have already established firm and mutual-benefit business relationships with customers from,Europe,America and south Asia,supplying obsolete and hard-to-find components to meet their specific needs.

With the principle of “Quality Parts,Customers Priority,Honest Operation,and Considerate Service”,our business mainly focus on the distribution of electronic components. Line cards we deal with include Microchip,ALPS,ROHM,Xilinx,Pulse,ON,Everlight and Freescale. Main products comprise IC,Modules,Potentiometer,IC Socket,Relay,Connector.Our parts cover such applications as commercial,industrial, and automotives areas.

We are looking forward to setting up business relationship with you and hope to provide you with the best service and solution. Let us make a better world for our industry!



## Contact us

Tel: +86-755-8981 8866 Fax: +86-755-8427 6832

Email & Skype: info@chipsmall.com Web: www.chipsmall.com

Address: A1208, Overseas Decoration Building, #122 Zhenhua RD., Futian, Shenzhen, China



**FEATURES**

**6.5  $\Omega$  (maximum) on resistance**  
**0.8  $\Omega$  (maximum) on-resistance flatness**  
**2.7 V to 5.5 V single supply**  
 **$\pm 2.7$  V to  $\pm 5.5$  V dual supply**  
**Rail-to-rail operation**  
**8-lead SOT-23, 8-lead MSOP**  
**Typical power consumption (<0.1  $\mu$ W)**  
**TTL-/CMOS-compatible inputs**

**APPLICATIONS**

**Automatic test equipment**  
**Power routing**  
**Communication systems**  
**Data acquisition systems**  
**Sample-and-hold systems**  
**Avionics**  
**Relay replacement**  
**Battery-powered systems**

**GENERAL DESCRIPTION**

The ADG619/ADG620 are monolithic, CMOS single-pole double-throw (SPDT) switches. Each switch conducts equally well in both directions when the device is on.

The ADG619/ADG620 offer a low on resistance of 4  $\Omega$ , which is matched to within 0.7  $\Omega$  between channels. These switches also provide low power dissipation, yet result in high switching speeds. The ADG619 exhibits break-before-make switching action, thus preventing momentary shorting when switching channels. The ADG620 exhibits make-before-break action.

The ADG619/ADG620 are available in an 8-lead SOT-23 and an 8-lead MSOP.

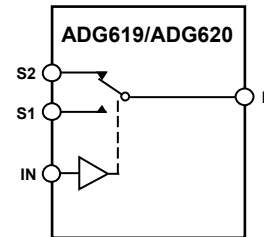
**FUNCTIONAL BLOCK DIAGRAM**

**NOTES**  
**1. SWITCHES SHOWN FOR A LOGIC 1 INPUT.**

Figure 1.

02617-001

**PRODUCT HIGHLIGHTS**

1. Low on resistance ( $R_{ON}$ ): 4  $\Omega$  typical.
2. Dual  $\pm 2.7$  V to  $\pm 5.5$  V or single 2.7 V to 5.5 V supplies.
3. Low power dissipation.
4. Fast  $t_{ON}/t_{OFF}$ .
5. Tiny, 8-lead SOT-23 and 8-lead MSOP.

**Table 1. Truth Table for the ADG619/ADG620**

IN	Switch S1	Switch S2
0	On	Off
1	Off	On

**Rev. C**

Information furnished by Analog Devices is believed to be accurate and reliable. However, no responsibility is assumed by Analog Devices for its use, nor for any infringements of patents or other rights of third parties that may result from its use. Specifications subject to change without notice. No license is granted by implication or otherwise under any patent or patent rights of Analog Devices. Trademarks and registered trademarks are the property of their respective owners.

## TABLE OF CONTENTS

Features .....	1	Absolute Maximum Ratings .....	6
Applications.....	1	ESD Caution.....	6
Functional Block Diagram .....	1	Pin Configurations and Function Descriptions .....	7
General Description .....	1	Typical Performance Characteristics .....	8
Product Highlights .....	1	Terminology .....	10
Revision History .....	2	Test Circuits.....	11
Specifications.....	3	Outline Dimensions .....	13
Dual Supply .....	3	Ordering Guide.....	14
Single Supply .....	5		

## REVISION HISTORY

<b>3/07—Rev. B to Rev. C</b>	
Changes to Specifications .....	3
<b>1/06—Rev. A to Rev. B</b>	
Changes to $R_{ON}$ Values in Table 2 .....	2
Updated Outline Dimensions .....	13
Changes to Ordering Guide .....	13
<b>6/03—Rev. 0 to Rev. A.</b>	
Edits to Specifications .....	2
Changes to Ordering Guide .....	4
Updated Outline Dimensions .....	8

# SPECIFICATIONS

## DUAL SUPPLY

$V_{DD} = +5\text{ V} \pm 10\%$ ,  $V_{SS} = -5\text{ V} \pm 10\%$ ,  $GND = 0\text{ V}$ . All specifications  $-40^\circ\text{C}$  to  $+85^\circ\text{C}$ , unless otherwise noted.

**Table 2.**

Parameter	B Version <sup>1</sup>		Unit	Test Conditions/Comments
	+25°C	-40°C to +85°C		
<b>ANALOG SWITCH</b>				
Analog Signal Range		$V_{SS}$ to $V_{DD}$	V	$V_{DD} = +4.5\text{ V}$ , $V_{SS} = -4.5\text{ V}$
On Resistance ( $R_{ON}$ )	4		$\Omega$ typ	$V_S = \pm 4.5\text{ V}$ , $I_{DS} = -10\text{ mA}$ ; see Figure 15
	6.5	8.5	$\Omega$ max	
$R_{ON}$ Match Between Channels ( $\Delta R_{ON}$ )	0.7		$\Omega$ typ	$V_S = \pm 4.5\text{ V}$ , $I_{DS} = -10\text{ mA}$
	1.1	1.35	$\Omega$ max	
On-Resistance Flatness ( $R_{FLAT(ON)}$ )	0.7	0.8	$\Omega$ typ	$V_S = \pm 3.3\text{ V}$ , $I_{DS} = -10\text{ mA}$
	1.35	1.4	$\Omega$ max	
<b>LEAKAGE CURRENTS</b>				
Source Off Leakage, $I_S$ (Off)	$\pm 0.01$		nA typ	$V_{DD} = +5.5\text{ V}$ , $V_{SS} = -5.5\text{ V}$
	$\pm 0.25$	$\pm 1$	nA max	$V_S = \pm 4.5\text{ V}$ , $V_D = \mp 4.5\text{ V}$ ; see Figure 16
Channel On Leakage, $I_D$ , $I_S$ (On)	$\pm 0.01$		nA typ	$V_S = V_D = \pm 4.5\text{ V}$ ; see Figure 17
	$\pm 0.25$	$\pm 1$	nA max	
<b>DIGITAL INPUTS</b>				
Input High Voltage, $V_{INH}$		2.4	V min	
Input Low Voltage, $V_{INL}$		0.8	V max	
Input Current, $I_{INL}$ or $I_{INH}$	0.005		$\mu\text{A}$ typ	$V_{IN} = V_{INL}$ or $V_{INH}$
		$\pm 0.1$	$\mu\text{A}$ max	
Digital Input Capacitance, $C_{IN}$	2		pF typ	
<b>DYNAMIC CHARACTERISTICS<sup>2</sup></b>				
<b>ADG619</b>				
$t_{ON}$	80		ns typ	$R_L = 300\ \Omega$ , $C_L = 35\text{ pF}$
	120	155	ns max	$V_S = 3.3\text{ V}$ ; see Figure 18
$t_{OFF}$	45		ns typ	$R_L = 300\ \Omega$ , $C_L = 35\text{ pF}$
	75	90	ns max	$V_S = 3.3\text{ V}$ ; see Figure 18
Break-Before-Make Time Delay, $t_{BBM}$	40		ns typ	$R_L = 300\ \Omega$ , $C_L = 35\text{ pF}$
		10	ns min	$V_{S1} = V_{S2} = 3.3\text{ V}$ ; see Figure 19
<b>ADG620</b>				
$t_{ON}$	40		ns typ	$R_L = 300\ \Omega$ , $C_L = 35\text{ pF}$
	65	85	ns max	$V_S = 3.3\text{ V}$ ; see Figure 18
$t_{OFF}$	200		ns typ	$R_L = 300\ \Omega$ , $C_L = 35\text{ pF}$
	330	400	ns max	$V_S = 3.3\text{ V}$ ; see Figure 18
Make-Before-Break Time Delay, $t_{MBS}$	160		ns typ	$R_L = 300\ \Omega$ , $C_L = 35\text{ pF}$
		10	ns min	$V_S = 0\text{ V}$ ; see Figure 20
Charge Injection	110		pC typ	$V_S = 0\text{ V}$ , $R_S = 0\ \Omega$ , $C_L = 1\text{ nF}$ ; see Figure 21
Off Isolation	-67		dB typ	$R_L = 50\ \Omega$ , $C_L = 5\text{ pF}$ , $f = 1\text{ MHz}$ ; see Figure 22
Channel-to-Channel Crosstalk	-67		dB typ	$R_L = 50\ \Omega$ , $C_L = 5\text{ pF}$ , $f = 1\text{ MHz}$ ; see Figure 23
Bandwidth -3 dB	190		MHz typ	$R_L = 50\ \Omega$ , $C_L = 5\text{ pF}$ ; see Figure 24
$C_S$ (Off)	25		pF typ	$f = 1\text{ MHz}$
$C_D$ , $C_S$ (On)	95		pF typ	$f = 1\text{ MHz}$

# ADG619/ADG620

Parameter	B Version <sup>1</sup>		Unit	Test Conditions/Comments
	+25°C	–40°C to +85°C		
POWER REQUIREMENTS				
$I_{DD}$	0.001	1.0	$\mu\text{A typ}$ $\mu\text{A max}$	$V_{DD} = +5.5\text{ V}, V_{SS} = -5.5\text{ V}$ Digital inputs = 0 V or 5.5 V
$I_{SS}$	0.001	1.0	$\mu\text{A typ}$ $\mu\text{A max}$	Digital inputs = 0 V or 5.5 V

<sup>1</sup> Temperature range for B version is –40°C to +85°C.

<sup>2</sup> Guaranteed by design, not subject to production test.

**SINGLE SUPPLY**

$V_{DD} = 5\text{ V} \pm 10\%$ ,  $V_{SS} = 0\text{ V}$ ,  $GND = 0\text{ V}$ . All specifications  $-40^{\circ}\text{C}$  to  $+85^{\circ}\text{C}$ , unless otherwise noted.

**Table 3.**

Parameter	B Version <sup>1</sup>		Unit	Test Conditions/Comments
	+25°C	-40°C to +85°C		
<b>ANALOG SWITCH</b>				
Analog Signal Range		0 V to $V_{DD}$	V	$V_{DD} = 4.5\text{ V}$ , $V_{SS} = 0\text{ V}$
On Resistance ( $R_{ON}$ )	7		$\Omega$ typ	$V_S = 0\text{ V}$ to $4.5\text{ V}$ , $I_{DS} = -10\text{ mA}$ ; see Figure 15
	10	12.5	$\Omega$ max	
$R_{ON}$ Match Between Channels ( $\Delta R_{ON}$ )	0.8		$\Omega$ typ	$V_S = 0\text{ V}$ to $4.5\text{ V}$ , $I_{DS} = -10\text{ mA}$
	1.1	1.3	$\Omega$ max	
On-Resistance Flatness ( $R_{FLAT(ON)}$ )	0.5	0.5	$\Omega$ typ	$V_S = 1.5\text{ V}$ to $3.3\text{ V}$ , $I_{DS} = -10\text{ mA}$
		1.2	$\Omega$ max	
<b>LEAKAGE CURRENTS</b>				
Source Off Leakage, $I_S$ (Off)	$\pm 0.01$		nA typ	$V_{DD} = 5.5\text{ V}$
	$\pm 0.25$	$\pm 1$	nA max	$V_S = 1\text{ V}/4.5\text{ V}$ , $V_D = 4.5\text{ V}/1\text{ V}$ ; see Figure 16
Channel On Leakage, $I_D$ , $I_S$ (On)	$\pm 0.01$		nA typ	$V_S = V_D = 1\text{ V}/4.5\text{ V}$ ; see Figure 17
	$\pm 0.25$	$\pm 1$	nA max	
<b>DIGITAL INPUTS</b>				
Input High Voltage, $V_{INH}$		2.4	V min	
Input Low Voltage, $V_{INL}$		0.8	V max	
Input Current, $I_{INL}$ or $I_{INH}$	0.005		$\mu\text{A}$ typ	$V_{IN} = V_{INL}$ or $V_{INH}$
		$\pm 0.1$	$\mu\text{A}$ max	
Digital Input Capacitance, $C_{IN}$	2		pF typ	
<b>DYNAMIC CHARACTERISTICS<sup>2</sup></b>				
<b>ADG619</b>				
$t_{ON}$	120		ns typ	$R_L = 300\ \Omega$ , $C_L = 35\text{ pF}$
	220	280	ns max	$V_S = 3.3\text{ V}$ ; see Figure 18
$t_{OFF}$	50		ns typ	$R_L = 300\ \Omega$ , $C_L = 35\text{ pF}$
	75	110	ns max	$V_S = 3.3\text{ V}$ ; see Figure 18
Break-Before-Make Time Delay, $t_{BBM}$	70		ns typ	$R_L = 300\ \Omega$ , $C_L = 35\text{ pF}$
		10	ns min	$V_{S1} = V_{S2} = 3.3\text{ V}$ ; see Figure 19
<b>ADG620</b>				
$t_{ON}$	50		ns typ	$R_L = 300\ \Omega$ , $C_L = 35\text{ pF}$
	85	110	ns max	$V_S = 3.3\text{ V}$ ; see Figure 18
$t_{OFF}$	210		ns typ	$R_L = 300\ \Omega$ , $C_L = 35\text{ pF}$
	340	420	ns max	$V_S = 3.3\text{ V}$ ; see Figure 18
Make-Before-Break Time Delay, $t_{MBB}$	170		ns typ	$R_L = 300\ \Omega$ , $C_L = 35\text{ pF}$
		10	ns min	$V_S = 3.3\text{ V}$ ; see Figure 20
Charge Injection	6		pC typ	$V_S = 0\text{ V}$ , $R_S = 0\ \Omega$ , $C_L = 1\text{ nF}$ ; see Figure 21
Off Isolation	-67		dB typ	$R_L = 50\ \Omega$ , $C_L = 5\text{ pF}$ , $f = 1\text{ MHz}$ ; see Figure 22
Channel-to-Channel Crosstalk	-67		dB typ	$R_L = 50\ \Omega$ , $C_L = 5\text{ pF}$ , $f = 1\text{ MHz}$ ; see Figure 23
Bandwidth -3 dB	190		MHz typ	$R_L = 50\ \Omega$ , $C_L = 5\text{ pF}$ ; see Figure 24
$C_S$ (OFF)	25		pF typ	$f = 1\text{ MHz}$
$C_D$ , $C_S$ (ON)	95		pF typ	$f = 1\text{ MHz}$
<b>POWER REQUIREMENTS</b>				
$I_{DD}$	0.001		$\mu\text{A}$ typ	$V_{DD} = 5.5\text{ V}$
		1.0	$\mu\text{A}$ max	Digital inputs = 0 V or 5.5 V

<sup>1</sup> Temperature range for B version is  $-40^{\circ}\text{C}$  to  $+85^{\circ}\text{C}$ .

<sup>2</sup> Guaranteed by design, not subject to production test.

## ABSOLUTE MAXIMUM RATINGS

T<sub>A</sub> = 25°C, unless otherwise noted.

Table 4.

Parameter	Rating
V <sub>DD</sub> to V <sub>SS</sub>	13 V
V <sub>DD</sub> to GND	−0.3 V to +6.5 V
V <sub>SS</sub> to GND	+0.3 V to −6.5 V
Analog Inputs <sup>1</sup>	V <sub>SS</sub> − 0.3 V to V <sub>DD</sub> + 0.3 V
Digital Inputs <sup>1</sup>	−0.3 V to V <sub>DD</sub> + 0.3 V or 30 mA (whichever occurs first)
Peak Current, S or D	100 mA (pulsed at 1 ms, 10% duty cycle maximum)
Continuous Current, S or D	50 mA
Operating Temperature Range Industrial (B Version)	−40°C to +85°C
Storage Temperature Range	−65°C to +150°C
Junction Temperature	150°C
MSOP	
θ <sub>JA</sub> Thermal Impedance	206°C/W
θ <sub>JC</sub> Thermal Impedance	44°C/W
SOT-23	
θ <sub>JA</sub> Thermal Impedance	229.6°C/W
θ <sub>JC</sub> Thermal Impedance	91.99°C/W
Lead Temperature, Soldering (10 sec)	300°C
IR Reflow, Peak Temperature	220°C

<sup>1</sup> Overvoltages at IN, S, or D are clamped by internal diodes. Current should be limited to the maximum ratings given.

Stresses above those listed under Absolute Maximum Ratings may cause permanent damage to the device. This is a stress rating only; functional operation of the device at these or any other conditions above those indicated in the operational section of this specification is not implied. Exposure to absolute maximum rating conditions for extended periods may affect device reliability.

Only one absolute maximum rating may be applied at a time.

### ESD CAUTION



**ESD (electrostatic discharge) sensitive device.** Charged devices and circuit boards can discharge without detection. Although this product features patented or proprietary protection circuitry, damage may occur on devices subjected to high energy ESD. Therefore, proper ESD precautions should be taken to avoid performance degradation or loss of functionality.



## PIN CONFIGURATIONS AND FUNCTION DESCRIPTIONS

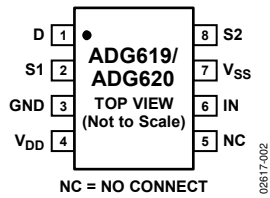

Figure 2. 8-Lead SOT-23 (RJ-8)

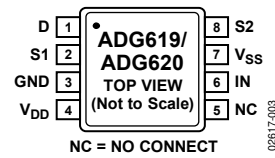

Figure 3. 8-Lead MSOP (RM-8)

Table 5. Pin Function Descriptions

Pin No.	Mnemonic	Description
1	D	Drain Terminal. Can be an input or output.
2	S1	Source Terminal. Can be an input or output.
3	GND	Ground (0 V) Reference.
4	V <sub>DD</sub>	Most Positive Power Supply.
5	NC	No Connect. Not internally connected.
6	IN	Logic Control Input.
7	V <sub>SS</sub>	Most Negative Power Supply. This pin is only used in dual-supply applications and should be tied to ground in single-supply applications.
8	S2	Source Terminal. Can be an input or output.



## TYPICAL PERFORMANCE CHARACTERISTICS

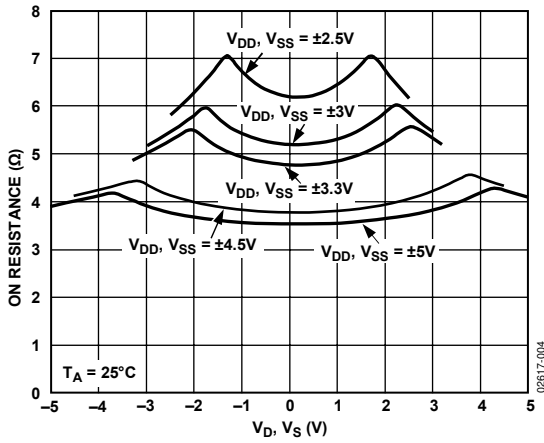

Figure 4. On Resistance vs.  $V_D, V_S$  (Dual Supply)

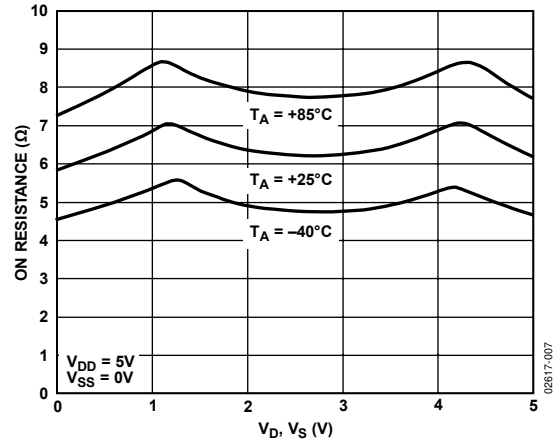

Figure 7. On Resistance vs.  $V_D, V_S$  for Different Temperatures (Single Supply)

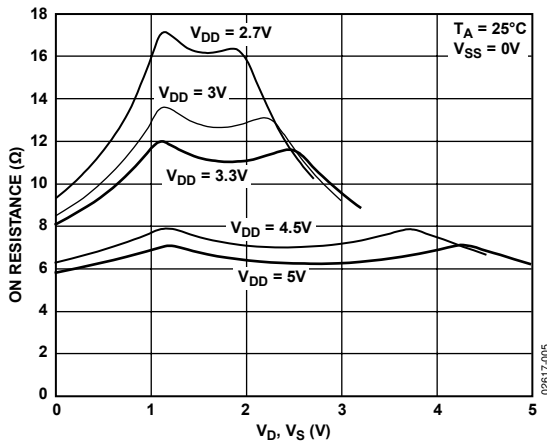

Figure 5. On Resistance vs.  $V_D, V_S$  (Single Supply)

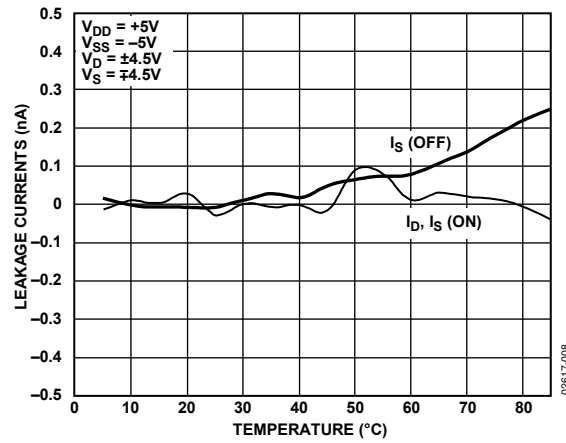

Figure 8. Leakage Currents vs. Temperature (Dual Supply)

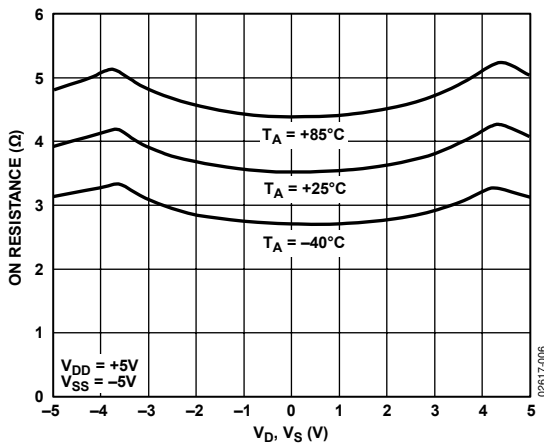

Figure 6. On Resistance vs.  $V_D, V_S$  for Different Temperatures (Dual Supply)

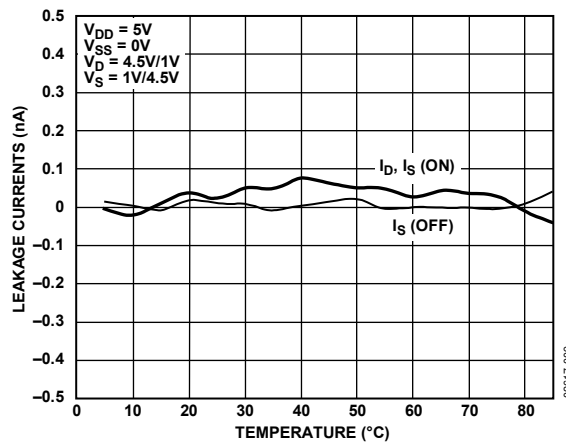

Figure 9. Leakage Currents vs. Temperature (Single Supply)

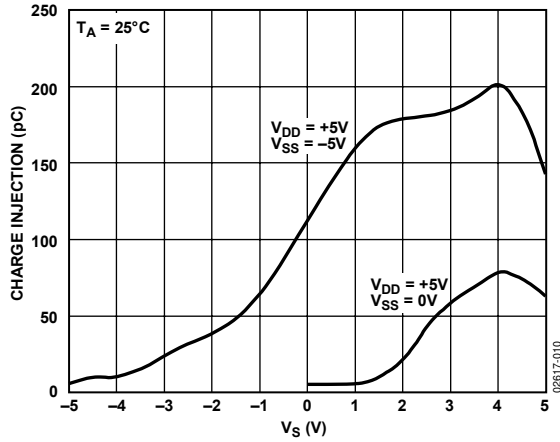

Figure 10. Charge Injection vs. Source Voltage

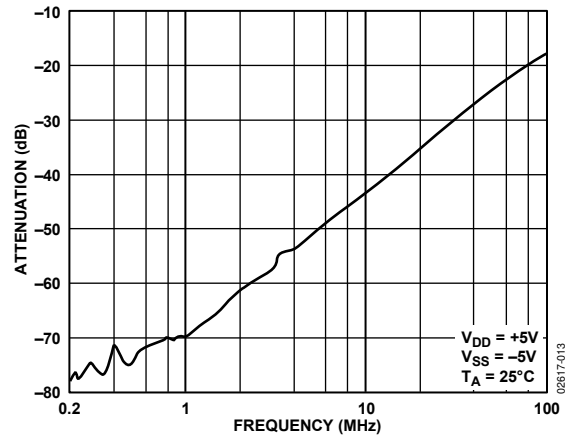

Figure 13. Crosstalk vs. Frequency

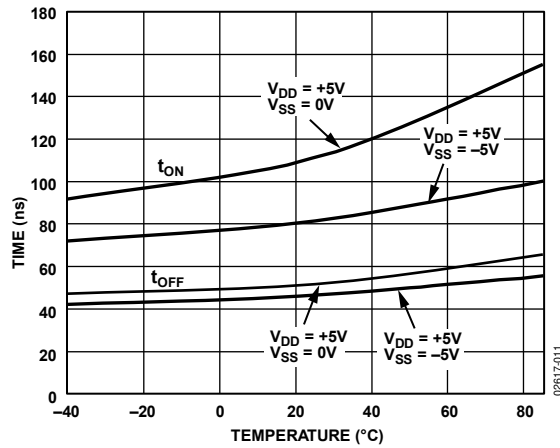

Figure 11.  $t_{ON}/t_{OFF}$  Times vs. Temperatures

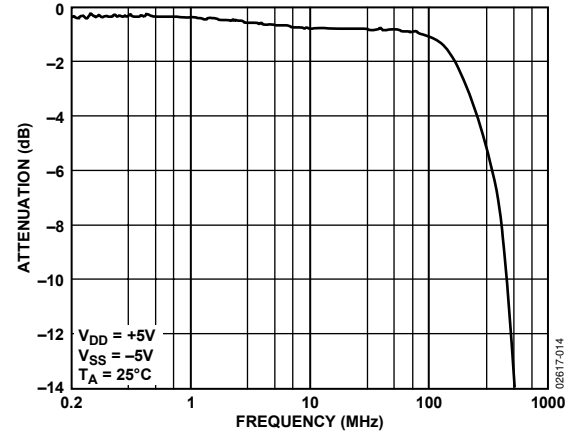

Figure 14. On Response vs. Frequency

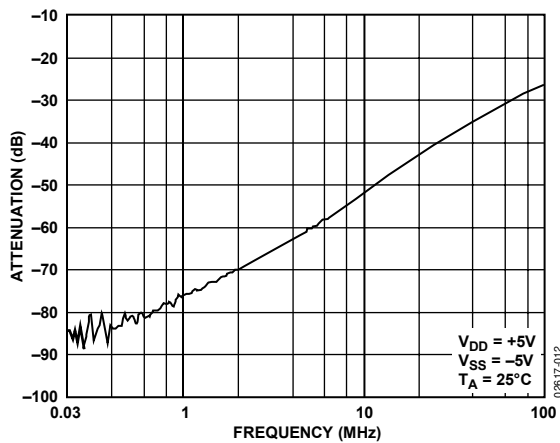

Figure 12. Off Isolation vs. Frequency

## TERMINOLOGY

**I<sub>DD</sub>**  
Positive supply current.

**I<sub>SS</sub>**  
Negative supply current.

**R<sub>ON</sub>**  
Ohmic resistance between D and S terminals.

**ΔR<sub>ON</sub>**  
On resistance match between any two channels.

**R<sub>FLAT (ON)</sub>**  
Flatness is defined as the difference between the maximum and minimum value of on resistance as measured over the specified analog signal range.

**I<sub>S (Off)</sub>**  
Source leakage current with the switch off.

**I<sub>D</sub>, I<sub>S (On)</sub>**  
Channel leakage current with the switch on.

**V<sub>D</sub>, V<sub>S</sub>**  
Analog voltage on Terminal D and Terminal S.

**V<sub>INL</sub>**  
Maximum input voltage for Logic 0.

**V<sub>INH</sub>**  
Minimum input voltage for Logic 1.

**I<sub>INL</sub>, I<sub>INH</sub>**  
Input current of the digital input.

**C<sub>S (Off)</sub>**  
Off switch source capacitance.

**C<sub>D</sub>, C<sub>S (On)</sub>**  
On switch capacitance.

**t<sub>ON</sub>**  
Delay between applying the digital control input and the output switching on.

**t<sub>OFF</sub>**  
Delay between applying the digital control input and the output switching off.

**t<sub>MBB</sub>**  
On time is measured between the 80% points of both switches, when switching from one address state to another.

**t<sub>BBM</sub>**  
Off time or on time is measured between the 90% points of both switches, when switching from one address state to another.

**Charge Injection**  
A measure of the glitch impulse transferred from the digital input to the analog output during switching.

**Crosstalk**  
A measure of unwanted signal coupled through from one channel to another as a result of parasitic capacitance.

**Off Isolation**  
A measure of unwanted signal coupling through an off switch.

**Bandwidth**  
The frequency response of the on switch.

**Insertion Loss**  
The loss due to the on resistance of the switch.

# TEST CIRCUITS

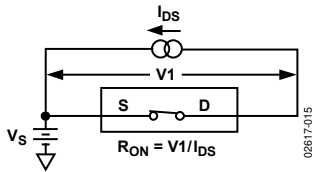

Figure 15. On Resistance

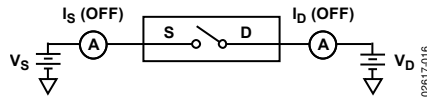

Figure 16. Off Leakage

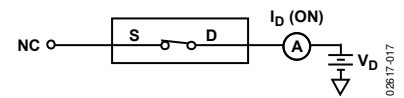

Figure 17. On Leakage

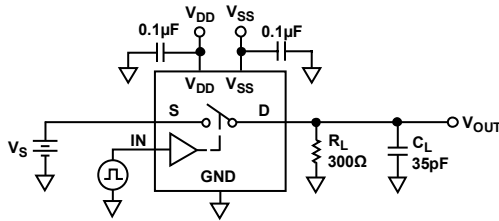

Figure 18. Switching Times

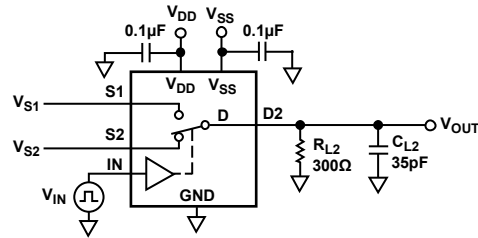
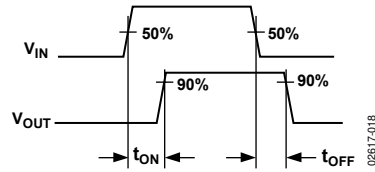

Figure 19. Break-Before-Make Time Delay,  $t_{BBM}$  (ADG619 Only)

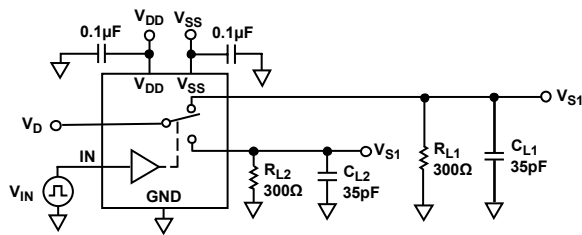
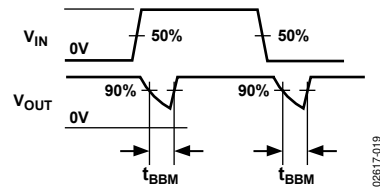

Figure 20. Make-Before-Break Time Delay,  $t_{MBB}$  (ADG620 Only)

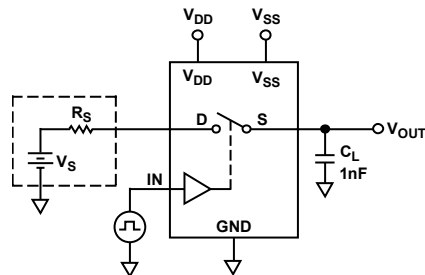
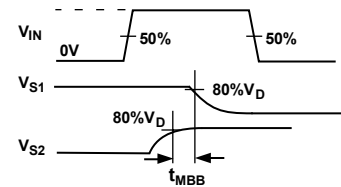
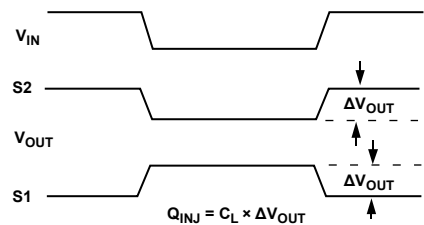

Figure 21. Charge Injection



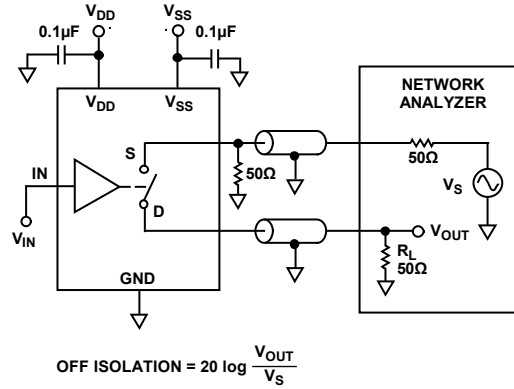

Figure 22. Off Isolation

02817-022

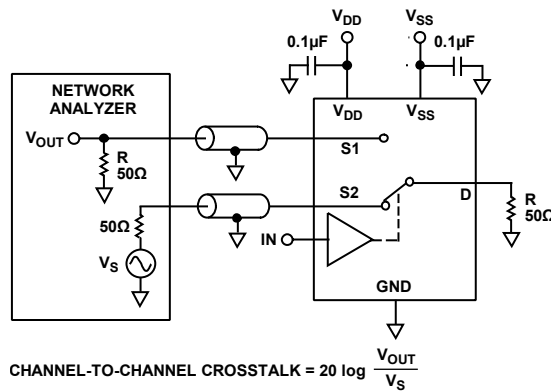

Figure 23. Channel-to-Channel Crosstalk

02817-023

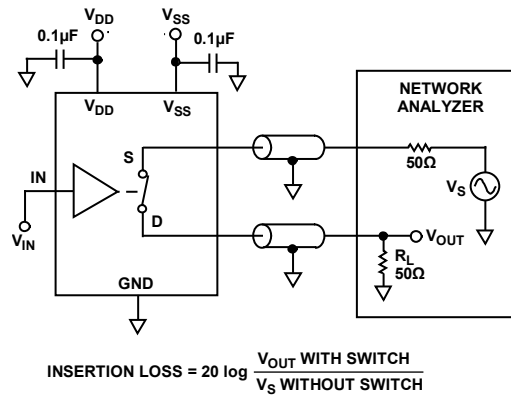
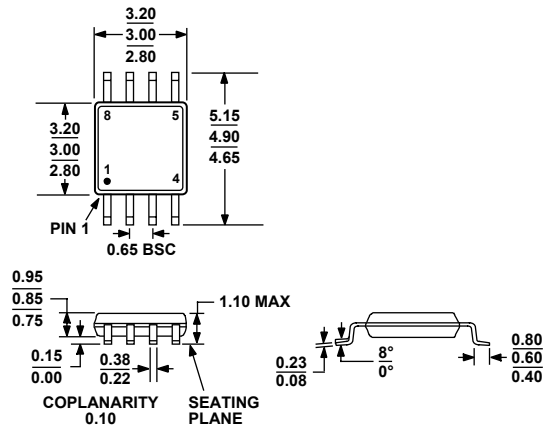

Figure 24. Bandwidth

02817-024

# OUTLINE DIMENSIONS



COMPLIANT TO JEDEC STANDARDS MO-187-AA

Figure 25. 8-Lead Mini Small Outline Package [MSOP] (RM-8)

Dimensions shown in millimeters

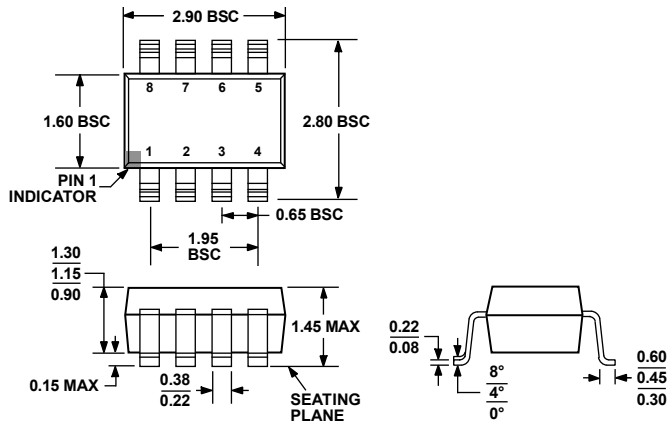

COMPLIANT TO JEDEC STANDARDS MO-178-BA

Figure 26. 8-Lead Small Outline Transistor Package [SOT-23] (RJ-8)

Dimensions shown in millimeters

# ADG619/ADG620

## ORDERING GUIDE

Model	Temperature Range	Package Description	Package Option	Branding <sup>1</sup>
ADG619BRM	-40°C to +85°C	8-Lead Mini Small Outline Package (MSOP)	RM-8	SVB
ADG619BRM-REEL	-40°C to +85°C	8-Lead Mini Small Outline Package (MSOP)	RM-8	SVB
ADG619BRM-REEL7	-40°C to +85°C	8-Lead Mini Small Outline Package (MSOP)	RM-8	SVB
ADG619BRMZ <sup>2</sup>	-40°C to +85°C	8-Lead Mini Small Outline Package (MSOP)	RM-8	SCC
ADG619BRMZ-REEL <sup>2</sup>	-40°C to +85°C	8-Lead Mini Small Outline Package (MSOP)	RM-8	SCC
ADG619BRMZ-REEL7 <sup>2</sup>	-40°C to +85°C	8-Lead Mini Small Outline Package (MSOP)	RM-8	SCC
ADG619BRT-REEL	-40°C to +85°C	8-Lead Small Outline Transistor Package (SOT-23)	RJ-8	SVB
ADG619BRT-REEL7	-40°C to +85°C	8-Lead Small Outline Transistor Package (SOT-23)	RJ-8	SVB
ADG619BRT-500RL7	-40°C to +85°C	8-Lead Small Outline Transistor Package (SOT-23)	RJ-8	SVB
ADG619BRTZ-REEL <sup>2</sup>	-40°C to +85°C	8-Lead Small Outline Transistor Package (SOT-23)	RJ-8	SCC
ADG619BRTZ-REEL7 <sup>2</sup>	-40°C to +85°C	8-Lead Small Outline Transistor Package (SOT-23)	RJ-8	SCC
ADG619BRTZ-500RL7 <sup>2</sup>	-40°C to +85°C	8-Lead Small Outline Transistor Package (SOT-23)	RJ-8	SCC
ADG620BRM	-40°C to +85°C	8-Lead Mini Small Outline Package (MSOP)	RM-8	SWB
ADG620BRM-REEL	-40°C to +85°C	8-Lead Mini Small Outline Package (MSOP)	RM-8	SWB
ADG620BRM-REEL7	-40°C to +85°C	8-Lead Mini Small Outline Package (MSOP)	RM-8	SWB
ADG620BRMZ <sup>2</sup>	-40°C to +85°C	8-Lead Mini Small Outline Package (MSOP)	RM-8	S21
ADG620BRT-REEL	-40°C to +85°C	8-Lead Small Outline Transistor Package (SOT-23)	RJ-8	SWB
ADG620BRT-REEL7	-40°C to +85°C	8-Lead Small Outline Transistor Package (SOT-23)	RJ-8	SWB
ADG620BRTZ-REEL7 <sup>2</sup>	-40°C to +85°C	8-Lead Small Outline Transistor Package (SOT-23)	RJ-8	S21

<sup>1</sup> Branding on SOT-23 and MSOP is limited to three characters due to space constraints.

<sup>2</sup> Z = RoHS Compliant Part.



**NOTES**

**NOTES**