



Chipsmall Limited consists of a professional team with an average of over 10 year of expertise in the distribution of electronic components. Based in Hongkong, we have already established firm and mutual-benefit business relationships with customers from,Europe,America and south Asia,supplying obsolete and hard-to-find components to meet their specific needs.

With the principle of “Quality Parts,Customers Priority,Honest Operation,and Considerate Service”,our business mainly focus on the distribution of electronic components. Line cards we deal with include Microchip,ALPS,ROHM,Xilinx,Pulse,ON,Everlight and Freescale. Main products comprise IC,Modules,Potentiometer,IC Socket,Relay,Connector.Our parts cover such applications as commercial,industrial, and automotives areas.

We are looking forward to setting up business relationship with you and hope to provide you with the best service and solution. Let us make a better world for our industry!



Contact us

Tel: +86-755-8981 8866 Fax: +86-755-8427 6832

Email & Skype: info@chipsmall.com Web: www.chipsmall.com

Address: A1208, Overseas Decoration Building, #122 Zhenhua RD., Futian, Shenzhen, China



FEATURES

- Triaxis digital gyroscope, $\pm 300^\circ/\text{sec}$
 - Tight orthogonal alignment: 0.05°
- Triaxis digital accelerometer: $\pm 18 g$
- Delta-angle/velocity calculations
- Wide sensor bandwidth: 330 Hz
- High sample rate: 2.460 kSPS
- Autonomous operation and data collection
 - No external configuration commands required
 - Startup time: 500 ms
- Factory-calibrated sensitivity, bias, and axial alignment
 - Calibration temperature range: -40°C to $+85^\circ\text{C}$
- SPI-compatible serial interface
- Embedded temperature sensor
- Programmable operation and control
 - Automatic and manual bias correction controls
 - 4 FIR filter banks, 120 configurable taps
 - Digital I/O: data-ready, alarm indicator, external clock
 - Alarms for condition monitoring
 - Power-down/sleep mode for power management
 - Enable external sample clock input: up to 2.25 kHz
 - Single-command self test
- Single-supply operation: 3.3 V
- 2000 g shock survivability
- Operating temperature range: -40°C to $+105^\circ\text{C}$

APPLICATIONS

- Precision instrumentation
- Platform stabilization and control
- Industrial vehicle navigation
- Downhole instrumentation
- Robotics

FUNCTIONAL BLOCK DIAGRAM

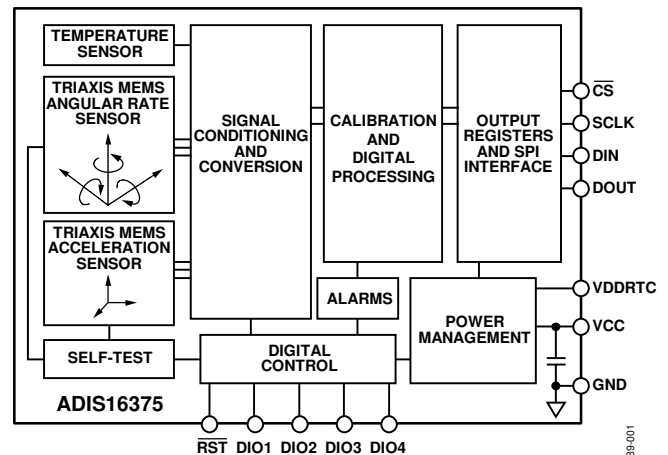

Figure 1.

GENERAL DESCRIPTION

The **ADIS16375** *iSensor*® is a complete inertial system that includes a triaxis gyroscope and triaxis accelerometer. Each sensor in the **ADIS16375** combines industry-leading *iMEMS*® technology with signal conditioning that optimizes dynamic performance. The factory calibration characterizes each sensor for sensitivity, bias, alignment, and linear acceleration (gyro bias). As a result, each sensor has its own dynamic compensation formulas that provide accurate sensor measurements over a temperature range of -40°C to $+105^\circ\text{C}$.

The **ADIS16375** provides a simple, cost-effective method for integrating accurate, multiaxis, inertial sensing into industrial systems, especially when compared with the complexity and investment associated with discrete designs. All necessary motion testing and calibration are part of the production process at the factory, greatly reducing system integration time. Tight orthogonal alignment simplifies inertial frame alignment in navigation systems. An improved SPI interface and register structure provide faster data collection and configuration control.

This compact module is approximately $44 \text{ mm} \times 47 \text{ mm} \times 14 \text{ mm}$ and provides a flexible connector interface that enables multiple mounting orientation options.

Rev. C

Information furnished by Analog Devices is believed to be accurate and reliable. However, no responsibility is assumed by Analog Devices for its use, nor for any infringements of patents or other rights of third parties that may result from its use. Specifications subject to change without notice. No license is granted by implication or otherwise under any patent or patent rights of Analog Devices. Trademarks and registered trademarks are the property of their respective owners.

ADIS16375* PRODUCT PAGE QUICK LINKS

Last Content Update: 02/23/2017

COMPARABLE PARTS

View a parametric search of comparable parts.

EVALUATION KITS

- Breakout Board for the ADIS1613x, ADIS1637x, ADIS1648x and ADIS1649x
- EVAL-ADIS Evaluation System

DOCUMENTATION

Application Notes

- AN-1295: Mechanical Design Tips for ADIS16375, ADIS16480, ADIS16485, and ADIS16488

Data Sheet

- ADIS16375: Anomaly Data Sheet
- ADIS16375: Low Profile, Low Noise Six Degrees of Freedom Inertial Sensor Data Sheet

User Guides

- UG-287: EVAL-ADIS: iSensor Evaluation System

SOFTWARE AND SYSTEMS REQUIREMENTS

- ADIS16480 IIO Inertial Measurement Unit Linux Driver

REFERENCE MATERIALS

Solutions Bulletins & Brochures

- Industrial ICs Solutions Bulletin, Volume 10, Issue 8
- iSensor MEMS Inertial Measurement Unit (IMU) Brochure

DESIGN RESOURCES

- adis16375 Material Declaration
- PCN-PDN Information
- Quality And Reliability
- Symbols and Footprints

DISCUSSIONS

View all adis16375 EngineerZone Discussions.

SAMPLE AND BUY

Visit the product page to see pricing options.

TECHNICAL SUPPORT

Submit a technical question or find your regional support number.

DOCUMENT FEEDBACK

Submit feedback for this data sheet.

TABLE OF CONTENTS

Features	1	Digital Signal Processing	17
Applications.....	1	Sampling Plan	17
Functional Block Diagram	1	Averaging/Decimation Filter	17
General Description	1	FIR Filter Banks	17
Revision History	2	Calibration.....	19
Specifications.....	3	Alarms.....	22
Timing Specifications	5	System Controls.....	23
Absolute Maximum Ratings.....	6	Global Commands	23
ESD Caution.....	6	Memory Management	23
Pin Configuration and Function Descriptions.....	7	General-Purpose I/O	24
Typical Performance Characteristics	8	Power Management.....	24
Basic Operation.....	9	Applications Information	26
Register Structure	9	Prototype Interface Board	26
SPI Communication.....	10	Installation Tips.....	26
Device Configuration	10	Outline Dimensions	27
Reading Sensor Data	10	Ordering Guide	27
User Registers.....	11		
Output Data Registers.....	13		

REVISION HISTORY

8/12—Rev. B to Rev. C

Changes to Features Section and General Description Section .	1
Changes to Table 2.....	5
Changes to Table 3.....	6
Changes to Basic Operation Section.....	9
Changes to Dual Memory Structure Section	10
Changes to Acceleration Section and Delta Angles Section.....	14
Changes to Figure 18.....	17
Changes to Table 71 to Table 76	20
Changes to Restoring Factory Calibration Section, Linear Acceleration on Effect on Gyroscope Bias Section, and Point of Percussion Alignment Section.....	21
Changes to Table 88.....	22
Changes to Automatic Self Test Section, Memory Management Section, and Flash Memory Test Section.....	23
Changes to General Purpose I/O Control Section.....	24
Changes to Real-Time Clock Configuration/Data Section	25
Changes to Prototype Interface Board and Figure 23.....	26
Updated Outline Dimensions	28
Changes to Ordering Guide	28

7/11—Rev. A to Rev. B

Changes to Accelerometers, Nonlinearity Parameter and Power Supply, VDD Parameter in Table 1	3
Changes to t_{CLS} , t_{CHS} , t_2 , and t_3 Parameters in Table 2.....	5
Changed Angular Displacement Heading to Delta Angles	14
Changes to Delta Angles Section.....	14
Changes to Table 28 and Velocity Changes Section.....	15
Change to Figure 18	17
Changes to Data-Ready Indicator Section and Input Sync/Clock Control Section.....	24
Moved Real-Time Clock Configuration/Data Section, Table 96, Table 97, and Table 98.....	25
Changes to Real-Time Clock Configuration/Data Section	25
Changes to Prototype Interface Board Section	26

2/11—Rev. 0 to Rev. A

Changes to Gyroscopes Misalignment and Accelerometers Misalignment Test Conditions/Comments, Table 1	3
Added Endnote 7.....	4
Changes to Table 54 and Table 55	17
Changes to Table 57, Table 58, and Table 59.....	18

10/10—Revision 0: Initial Version

SPECIFICATIONS

$T_A = 25^\circ\text{C}$, $V_{DD} = 3.3\text{ V}$, angular rate = $0^\circ/\text{sec}$, dynamic range = $\pm 300^\circ/\text{sec} \pm 1\text{ g}$, unless otherwise noted.

Table 1.

Parameter	Test Conditions/Comments	Min	Typ	Max	Unit
GYROSCOPES					
Dynamic Range		± 300	± 350		$^\circ/\text{sec}$
Sensitivity ¹	16-bit resolution, x_GYRO_OUT registers only		0.01311		$^\circ/\text{sec}/\text{LSB}$
Initial Sensitivity Tolerance				± 1	%
Sensitivity Temperature Coefficient	$-40^\circ\text{C} \leq T_A \leq +85^\circ\text{C}$		± 40		ppm/ $^\circ\text{C}$
Misalignment	Axis-to-axis		± 0.05		Degrees
	Axis-to-frame (package)		± 1.0		Degrees
Nonlinearity	Best-fit straight line		± 0.025		% of FS
Initial Bias Error	$\pm 1\sigma$		± 1.0		$^\circ/\text{sec}$
In-Run Bias Stability	1σ		12		$^\circ/\text{hr}$
Angular Random Walk	1σ		1.0		$^\circ/\sqrt{\text{hr}}$
Bias Temperature Coefficient	$-40^\circ\text{C} \leq T_A \leq +85^\circ\text{C}$		± 0.005		$^\circ/\text{sec}/^\circ\text{C}$
Linear Acceleration Effect on Bias	Any axis, 1σ (GEN_CONFIG[7] = 1)		± 0.013		$^\circ/\text{sec}/\text{g}$
Output Noise	No filtering		0.45		$^\circ/\text{sec rms}$
Rate Noise Density	$f = 25\text{ Hz}$, no filtering		0.02		$^\circ/\text{sec}/\sqrt{\text{Hz rms}}$
3 dB Bandwidth			330		Hz
Sensor Resonant Frequency			14.5		kHz
ACCELEROMETERS					
Dynamic Range	Each axis	± 18			<i>g</i>
Sensitivity ¹	16-bit resolution, x_ACCL_OUT registers only		0.8192		mg/LSB
Initial Sensitivity Tolerance				± 1	%
Sensitivity Temperature Coefficient	$-40^\circ\text{C} \leq T_A \leq +85^\circ\text{C}$		± 25		ppm/ $^\circ\text{C}$
Misalignment	Axis-to-axis		± 0.035		Degrees
	Axis-to-frame (package)		± 1.0		Degrees
Nonlinearity	Best-fit straight line, $\pm 10\text{ g}$		± 0.1		% of FS
	Best-fit straight line, $\pm 18\text{ g}$		± 0.5		% of FS
Initial Bias Error	$\pm 1\sigma$		± 16		mg
In-Run Bias Stability	1σ		0.13		mg
Velocity Random Walk	1σ		0.076		m/sec/ $\sqrt{\text{hr}}$
Bias Temperature Coefficient	$-40^\circ\text{C} \leq T_A \leq +85^\circ\text{C}$		± 0.1		mg/ $^\circ\text{C}$
Output Noise	No filtering		1.5		mg rms
Noise Density	No filtering		0.06		mg/ $\sqrt{\text{Hz rms}}$
3 dB Bandwidth			330		Hz
Sensor Resonant Frequency			5.5		kHz
TEMPERATURE SENSOR					
Scale Factor	Output = 0x0000 at 25°C ($\pm 5^\circ\text{C}$)		0.00565		$^\circ\text{C}/\text{LSB}$
LOGIC INPUTS²					
Input High Voltage, V_{IH}		2.0			V
Input Low Voltage, V_{IL}				0.8	V
CS Wake-Up Pulse Width		20			μs
Logic 1 Input Current, I_{IH}	$V_{IH} = 3.3\text{ V}$			10	μA
Logic 0 Input Current, I_{IL}	$V_{IL} = 0\text{ V}$			10	μA
All Pins Except $\overline{\text{RST}}$				10	μA
$\overline{\text{RST}}$ Pin			0.33		mA
Input Capacitance, C_{IN}			10		pF
DIGITAL OUTPUTS					
Output High Voltage, V_{OH}	$I_{SOURCE} = 0.5\text{ mA}$	2.4			V
Output Low Voltage, V_{OL}	$I_{SINK} = 2.0\text{ mA}$			0.4	V

Parameter	Test Conditions/Comments	Min	Typ	Max	Unit
FLASH MEMORY Data Retention ⁴	Endurance ³ $T_J = 85^\circ\text{C}$	100,000 20			Cycles Years
FUNCTIONAL TIMES ⁵ Power-On Startup Time Reset Recovery Time Sleep Mode Recovery Time Flash Memory Update Time Flash Memory Test Time Automatic Self Test Time	Time until data is available Using internal clock, 100 SPS		500 500 500 375 50 10		ms ms μs ms ms ms
CONVERSION RATE Initial Clock Accuracy Temperature Coefficient Sync Input Clock			2.46 0.02 40 0.7 ⁶	2.25	kSPS % ppm/ $^\circ\text{C}$ kHz
POWER SUPPLY, VDD Power Supply Current ⁷	Operating voltage range Normal mode, VDD = 3.3 V Sleep mode, VDD = 3.3 V Power-down mode, VDD = 3.3 V	3.0		3.6	V mA mA μA
POWER SUPPLY, VDDRTC Real-Time Clock Supply Current	Operating voltage range Normal mode, VDDRTC = 3.3 V		3.3 13		V μA

¹ Each gyroscope and accelerometer has 32 bits of available resolution. The 16-bit sensitivity shown reflects the register that contains the upper 16 bits of the sensor output. Divide this number by 2 for every bit added to this resolution in downstream processing routines.

² The digital I/O signals are driven by an internal 3.3 V supply, and the inputs are 5 V tolerant.

³ Endurance is qualified as per JEDEC Standard 22, Method A117, and measured at -40°C , $+25^\circ\text{C}$, $+85^\circ\text{C}$, and $+125^\circ\text{C}$.

⁴ The data retention lifetime equivalent is at a junction temperature (T_J) of 85°C as per JEDEC Standard 22, Method A117. Data retention lifetime decreases with junction temperature.

⁵ These times do not include thermal settling and internal filter response times (330 Hz bandwidth), which may affect overall accuracy.

⁶ The 0.7 kHz lower limit is established to support Nyquist sampling criteria for the 330 Hz sensor bandwidth.

⁷ During startup, the power supply current increases and experiences transient behaviors for a period of 400 μs . The peak current during the 400 μs transient period can reach 1500 mA.

TIMING SPECIFICATIONS

T_A = 25°C, VDD = 3.3 V, unless otherwise noted.

Table 2.

Parameter	Description	Min ¹	Normal Mode		Unit
			Typ	Max	
f _{SCLK}	Serial clock	0.01		15	MHz
t _{STALL}	Stall period between data	2			μs
t _{CLS}	Serial clock low period	31			ns
t _{CHS}	Serial clock high period	31			ns
t _{CS}	Chip select to clock edge	32			ns
t _{DAV}	DOUT valid after SCLK edge			10	ns
t _{DSU}	DIN setup time before SCLK rising edge	2			ns
t _{DHD}	DIN hold time after SCLK rising edge	2			ns
t _{DR} , t _{DF}	DOUT rise/fall times, ≤100 pF loading		3	8	ns
t _{DSOE}	CS assertion to data out active	0		11	ns
t _{HD}	SCLK edge to data out invalid	0			ns
t _{SFS}	Last SCLK edge to CS deassertion	32			ns
t _{DSHI}	CS deassertion to data out high impedance	0		9	ns
t ₁	Input sync pulse width	5			μs
t ₂	Input sync to data-ready output			430	μs
t ₃	Input sync period	440			μs

¹ Guaranteed by design and characterization but not tested in production.

Timing Diagrams

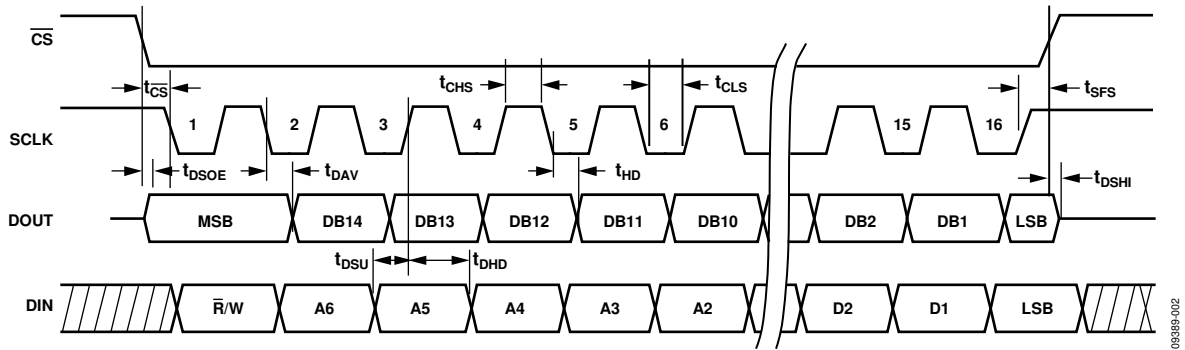

Figure 2. SPI Timing and Sequence

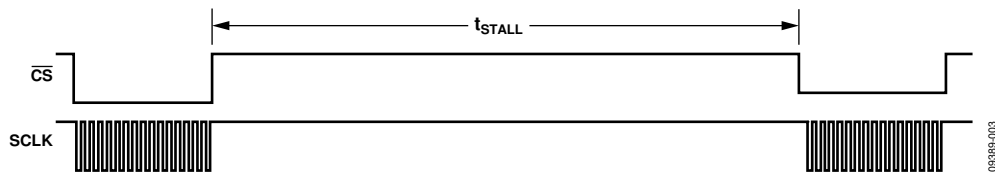

Figure 3. Stall Time and Data Rate

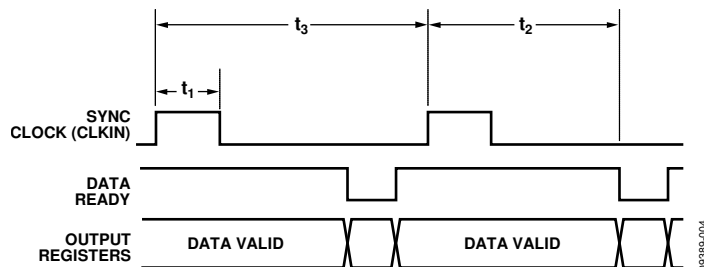

Figure 4. Input Clock Timing Diagram

ABSOLUTE MAXIMUM RATINGS

Table 3.

Parameter	Rating
Acceleration	
Any Axis, Unpowered	2000 <i>g</i>
Any Axis, Powered	2000 <i>g</i>
VCC to GND	-0.3 V to +3.6 V
Digital Input Voltage to GND	-0.3 V to VCC + 0.2 V
Digital Output Voltage to GND	-0.3 V to VCC + 0.2 V
Operating Temperature Range	-40°C to +105°C
Storage Temperature Range	-65°C to +150°C ¹

¹ Extended exposure to temperatures outside the specified temperature range of -40°C to +105°C can adversely affect the accuracy of the factory calibration. For best accuracy, store the parts within the specified operating range of -40°C to +105°C.

Stresses above those listed under Absolute Maximum Ratings may cause permanent damage to the device. This is a stress rating only; functional operation of the device at these or any other conditions above those indicated in the operational section of this specification is not implied. Exposure to absolute maximum rating conditions for extended periods may affect device reliability.

Table 4. Package Characteristics

Package Type	θ_{JA}	θ_{JC}	Device Weight
24-Lead Module (ML-24-3)	20.5	6.3	25 <i>g</i>

ESD CAUTION



ESD (electrostatic discharge) sensitive device. Charged devices and circuit boards can discharge without detection. Although this product features patented or proprietary protection circuitry, damage may occur on devices subjected to high energy ESD. Therefore, proper ESD precautions should be taken to avoid performance degradation or loss of functionality.

PIN CONFIGURATION AND FUNCTION DESCRIPTIONS

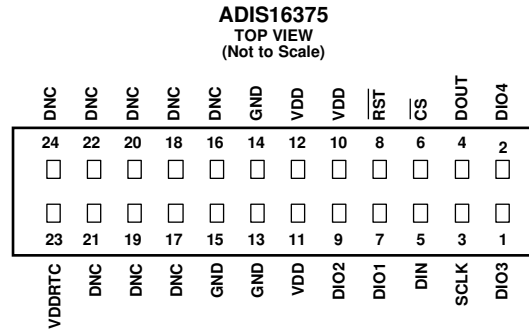

- NOTES**
1. THIS REPRESENTATION DISPLAYS THE TOP VIEW PINOUT FOR THE MATING SOCKET CONNECTOR.
 2. THE ACTUAL CONNECTOR PINS ARE NOT VISIBLE FROM THE TOP VIEW.
 3. MATING CONNECTOR: SAMTEC CLM-112-02 OR EQUIVALENT.
 4. DNC = DO NOT CONNECT.

09389-005

Figure 5. Mating Connector Pin Assignments

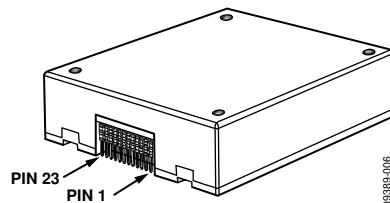

09389-006

Figure 6. Axial Orientation (Top Side Facing Up)

Table 5. Pin Function Descriptions

Pin No.	Mnemonic	Type	Description
1	DIO3	Input/Output	Configurable Digital Input/Output.
2	DIO4	Input/Output	Configurable Digital Input/Output.
3	SCLK	Input	SPI Serial Clock.
4	DOUT	Output	SPI Data Output. Clocks output on SCLK falling edge.
5	DIN	Input	SPI Data Input. Clocks input on SCLK rising edge.
6	CS	Input	SPI Chip Select.
7	DIO1	Input/Output	Configurable Digital Input/Output.
8	RST	Input	Reset.
9	DIO2	Input/Output	Configurable Digital Input/Output.
10, 11, 12	VDD	Supply	Power Supply.
13, 14, 15	GND	Supply	Power Ground.
16 to 22, 24	DNC	Not applicable	Do Not Connect.
23	VDDRTC	Supply	Real-Time Clock Power Supply.

TYPICAL PERFORMANCE CHARACTERISTICS

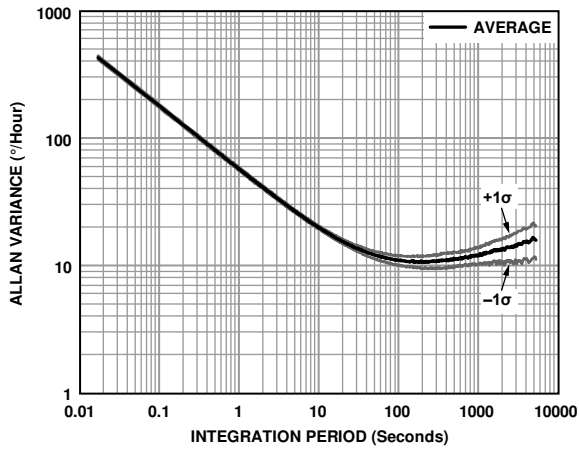

Figure 7. Gyroscope Allan Variance, +25°C

093389-007

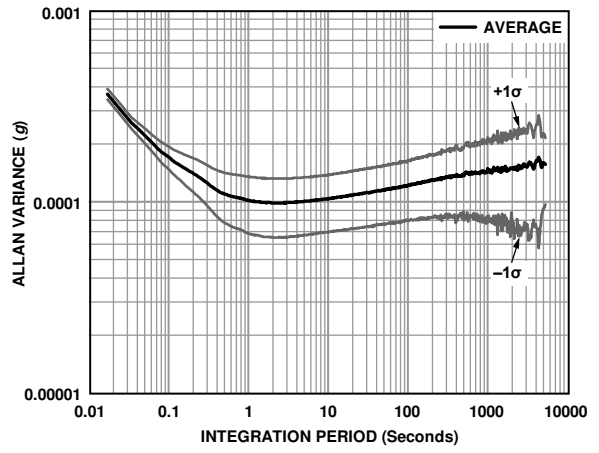

Figure 8. Accelerometer Allan Variance, 25°C

093389-008

BASIC OPERATION

The ADIS16375 is an autonomous sensor system that starts up on its own when it has a valid power supply. After running through its initialization process, it begins sampling, processing, and loading calibrated sensor data into the output registers, which are accessible using the SPI port. The SPI port typically connects to a compatible port on an embedded processor, using the connection diagram in Figure 9. The four SPI signals facilitate synchronous, serial data communication. Connect RST (see Table 5) to a digital I/O line for remote reset control or leave it open for normal operation. The factory default configuration provides users with a data-ready signal on the DIO2 pin, which pulses high when new data is available in the output data registers.

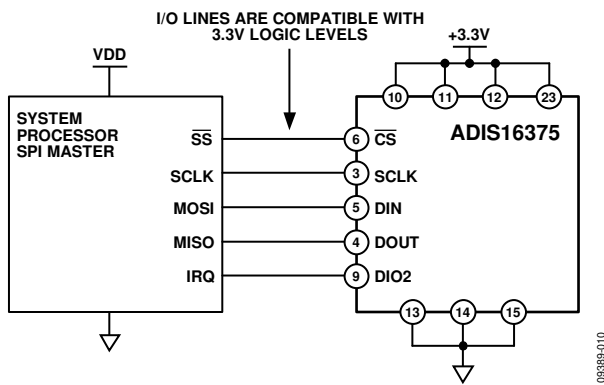

Figure 9. Electrical Connection Diagram

Table 6. Generic Master Processor Pin Names and Functions

Mnemonic	Function
SS	Slave select
IRQ	Interrupt request
MOSI	Master output, slave input
MISO	Master input, slave output
SCLK	Serial clock

Embedded processors typically use control registers to configure their serial ports for communicating with SPI slave devices, such as the ADIS16375. Table 7 provides a list of settings, which describe the SPI protocol of the ADIS16375. The initialization routine of the master processor typically establishes these settings using firmware commands to write them into its serial control registers.

Table 7. Generic Master Processor SPI Settings

Processor Setting	Description
Master	The ADIS16375 operates as a slave.
SCLK ≤ 15 MHz	Maximum serial clock rate.
SPI Mode 3	CPOL = 1 (polarity), and CPHA = 1 (phase).
MSB-First Mode	Bit sequence.
16-Bit Mode	Shift register/data length.

REGISTER STRUCTURE

The register structure and SPI port provide a bridge between the sensor processing system and an external, master processor. It contains both output data and control registers. The output data registers include the latest sensor data, a real-time clock, error flags, alarm flags, and identification data. The control registers include sample rate, filtering, input/output, alarms, calibration, and diagnostic configuration options. All communication between the ADIS16375 and an external processor involves either reading or writing to one of the user registers.

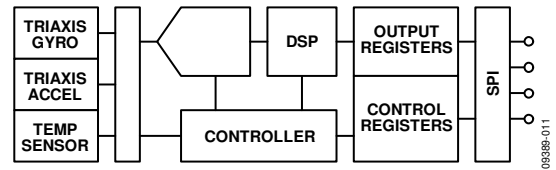

Figure 10. Basic Operation

The register structure uses a paged addressing scheme that is comprised of 13 pages, with each one containing 64 register locations. Each register is 16-bits wide, with each byte having its own unique address within that page's memory map. The SPI port has access to one page at a time, using the bit sequences in Figure 15. Select the page to activate for SPI access by writing its code to the PAGE_ID register. Read the PAGE_ID register to determine which page is currently active. Table 8 displays the PAGE_ID contents for each page, along with their basic function. The PAGE_ID register is located at Address 0x00 on every page.

Table 8. User Register Page Assignments

Page	PAGE ID	Function
0	0x00	Output data, clock, identification
1	0x01	Reserved
2	0x02	Calibration
3	0x03	Control: sample rate, filtering, I/O, alarms
4	0x04	Reserved
5	0x05	FIR Filter Bank A Coefficients, 1 to 60
6	0x06	FIR Filter Bank A, Coefficients, 61 to 120
7	0x07	FIR Filter Bank B, Coefficients, 1 to 60
8	0x08	FIR Filter Bank B, Coefficients, 61 to 120
9	0x09	FIR Filter Bank C, Coefficients, 1 to 60
10	0x0A	FIR Filter Bank C, Coefficients, 61 to 120
11	0x0B	FIR Filter Bank D, Coefficients, 1 to 60
12	0x0C	FIR Filter Bank D, Coefficients, 61 to 120

SPI COMMUNICATION

The SPI port supports full duplex communication, as shown in Figure 15, which enables external processors to write to DIN while reading DOUT, if the previous command was a read request. Figure 15 provides a guideline for the bit coding on both DIN and DOUT.

DEVICE CONFIGURATION

The SPI provides write access to the control registers, one byte at a time, using the bit assignments shown in Figure 15. Each register has 16 bits, where Bits[7:0] represent the lower address (listed in Table 9) and Bits[15:8] represent the upper address. Write to the lower byte of a register first, followed by a write to its upper byte second. The only register that changes with a single write to its lower byte is the PAGE_ID register. For a write command, the first bit in the DIN sequence is set to 1. The Address Bits[A6:A0] represent the target address and the Data Command Bits[DC7:DC0] represent the data being written to the location. Figure 11 provides an example of writing 0x03 to Address 0x00 (PAGE_ID[7:0]), using DIN = 0x8003. This write command activates the control page for SPI access.

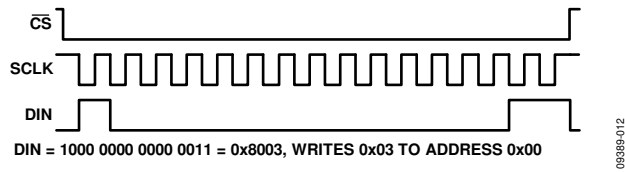

Figure 11. SPI Sequence for Activating the Control Page (DIN = 0x8003)

Dual Memory Structure

Writing configuration data to a control register updates its SRAM contents, which are volatile. After optimizing each relevant control register setting in a system, use the manual flash update command, which is located in GLOB_CMD[3] on Page 3 of the register map. Activate the manual flash update command by turning to Page 3 (DIN = 0x8003) and setting GLOB_CMD[3] = 1 (DIN = 0x8204, then DIN = 0x8300). Make sure that the power supply is within specification for the entire 375 ms processing time for a flash memory update. Table 9 provides a memory map for all of the user registers, which includes a column for the flash backup support associated with each register. A yes in this column indicates that a register has a mirror location in flash and, when backed up properly, automatically restores itself during startup or after a reset. Figure 12 provides a diagram of the dual memory structure used to manage operation and store critical user settings.

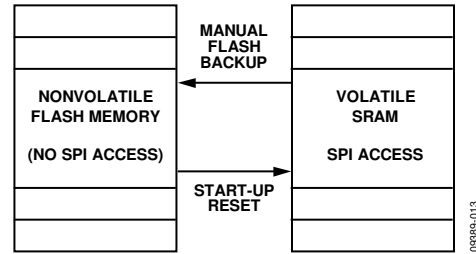

Figure 12. SRAM and Flash Memory Diagram

READING SENSOR DATA

The ADIS16375 automatically starts up and activates Page 0 for data register access. Write 0x00 to the PAGE_ID register (DIN = 0x8000) to activate Page 0 for data access after accessing any other page. A single register read requires two 16-bit SPI cycles. The first cycle requests the contents of a register using the bit assignments in Figure 15, and then the register contents flow out of DOUT during the second sequence. The first bit in a DIN command is zero, followed by either the upper or lower address for the register. The last eight bits are don't care, but the SPI requires the full set of 16 SCLKs to receive the request. Figure 13 includes two register reads in succession, which starts with DIN = 0x1A00 to request the contents of the Z_GYRO_OUT register and follows with 0x1800 to request the contents of the Z_GYRO_LOW register.

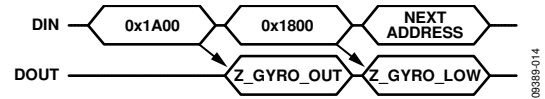

Figure 13. SPI Read Example

Figure 14 provides an example of the four SPI signals when reading PROD_ID in a repeating pattern. This is a good pattern to use for troubleshooting the SPI interface setup and communications because the contents of PROD_ID are predefined and stable.

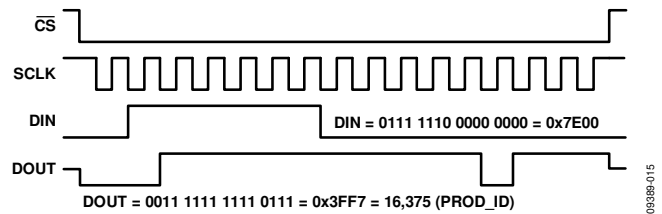
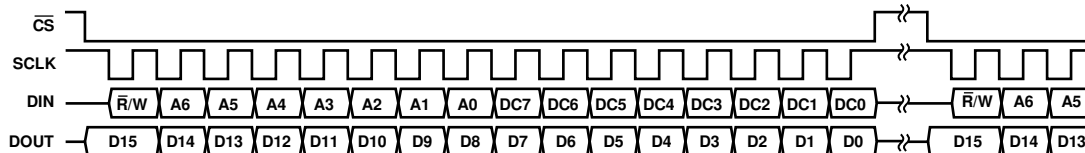

Figure 14. SPI Read Example, Second 16-Bit Sequence



NOTES

1. DOUT BITS ARE PRODUCED ONLY WHEN THE PREVIOUS 16-BIT DIN SEQUENCE STARTS WITH R/W = 0.
2. WHEN CS IS HIGH, DOUT IS IN A THREE-STATE, HIGH IMPEDANCE MODE, WHICH ALLOWS MULTIFUNCTIONAL USE OF THE LINE FOR OTHER DEVICES.

Figure 15. SPI Communication Bit Sequence

USER REGISTERS

Table 9. User Register Memory Map (N/A = Not Applicable)

Name	R/W	Flash	PAGE_ID	Address	Default	Register Description	Format
PAGE_ID	R/W	No	0x00	0x00	0x00	Page Identifier	N/A
Reserved	N/A	N/A	0x00	0x02 to 0x07	N/A	Reserved	N/A
SYS_E_FLAG	R	No	0x00	0x08	0x0000	Output, system error flags	Table 41
DIAG_STS	R	No	0x00	0x0A	0x0000	Output, self test error flags	Table 42
ALM_STS	R	No	0x00	0x0C	0x0000	Output, alarm error flags	Table 43
TEMP_OUT	R	No	0x00	0x0E	N/A	Output, temperature	Table 39
X_GYRO_LOW	R	No	0x00	0x10	N/A	Output, x-axis gyroscope, low word	Table 15
X_GYRO_OUT	R	No	0x00	0x12	N/A	Output, x-axis gyroscope, high word	Table 11
Y_GYRO_LOW	R	No	0x00	0x14	N/A	Output, y-axis gyroscope, low word	Table 16
Y_GYRO_OUT	R	No	0x00	0x16	N/A	Output, y-axis gyroscope, high word	Table 12
Z_GYRO_LOW	R	No	0x00	0x18	N/A	Output, z-axis gyroscope, low word	Table 17
Z_GYRO_OUT	R	No	0x00	0x1A	N/A	Output, z-axis gyroscope, high word	Table 13
X_ACCL_LOW	R	No	0x00	0x1C	N/A	Output, x-axis accelerometer, low word	Table 22
X_ACCL_OUT	R	No	0x00	0x1E	N/A	Output, x-axis accelerometer, high word	Table 18
Y_ACCL_LOW	R	No	0x00	0x20	N/A	Output, y-axis accelerometer, low word	Table 23
Y_ACCL_OUT	R	No	0x00	0x22	N/A	Output, y-axis accelerometer, high word	Table 19
Z_ACCL_LOW	R	No	0x00	0x24	N/A	Output, z-axis accelerometer, low word	Table 24
Z_ACCL_OUT	R	No	0x00	0x26	N/A	Output, z-axis accelerometer, high word	Table 20
Reserved	N/A	N/A	0x00	0x28 to 0x3F	N/A	Reserved	N/A
X_DELTA_ANG_L	R	No	0x00	0x40	N/A	Output, x-axis delta angle, low word	Table 29
X_DELTA_ANG_H	R	No	0x00	0x42	N/A	Output, x-axis delta angle, high word	Table 25
Y_DELTA_ANG_L	R	No	0x00	0x44	N/A	Output, y-axis delta angle, low word	Table 30
Y_DELTA_ANG_H	R	No	0x00	0x46	N/A	Output, y-axis delta angle, high word	Table 26
Z_DELTA_ANG_L	R	No	0x00	0x48	N/A	Output, z-axis delta angle, low word	Table 31
Z_DELTA_ANG_H	R	No	0x00	0x4A	N/A	Output, z-axis delta angle, high word	Table 27
X_DELTA_VEL_L	R	No	0x00	0x4C	N/A	Output, x-axis delta velocity, low word	Table 36
X_DELTA_VEL_H	R	No	0x00	0x4E	N/A	Output, x-axis delta velocity, high word	Table 32
Y_DELTA_VEL_L	R	No	0x00	0x50	N/A	Output, y-axis delta velocity, low word	Table 37
Y_DELTA_VEL_H	R	No	0x00	0x52	N/A	Output, y-axis a delta velocity, high word	Table 33
Z_DELTA_VEL_L	R	No	0x00	0x54	N/A	Output, z-axis delta velocity, low word	Table 38
Z_DELTA_VEL_H	R	No	0x00	0x56	N/A	Output, z-axis delta velocity, high word	Table 34
Reserved	N/A	N/A	0x00	0x58 to 0x6F	N/A	Reserved	N/A
TIME_MS_OUT	R/W	Yes	0x00	0x70	N/A	Output, time, minutes, and seconds	Table 96
TIME_DH_OUT	R/W	Yes	0x00	0x72	N/A	Output, time, days, and hours	Table 97
TIME_YM_OUT	R/W	Yes	0x00	0x74	N/A	Output, time, years, and months	Table 98
Reserved	N/A	N/A	0x00	0x76	N/A	Reserved	N/A
LOT_ID1	R	Yes	0x00	0x78	N/A	Output, lot identification number	Table 44
LOT_ID2	R	Yes	0x00	0x7A	N/A	Output, lot identification number	Table 45
LOT_ID3	R	Yes	0x00	0x7C	N/A	Output, lot identification number	Table 46
PROD_ID	R	Yes	0x00	0x7E	0x3FF7	Output, product identification (16,375)	Table 47
Reserved	N/A	N/A	0x01	0x00 to 0x7F	N/A	Reserved	N/A
PAGE_ID	R/W	No	0x02	0x00	0x00	Page identifier	N/A
Reserved	N/A	N/A	0x02	0x02 to 0x0E	N/A	Reserved	N/A
XGYRO_OFF_L	R/W	Yes	0x02	0x10	0x0000	Calibration, offset, x-axis gyroscope, low word	Table 62
XGYRO_OFF_H	R/W	Yes	0x02	0x12	0x0000	Calibration, offset, x-axis gyroscope, high word	Table 59
YGYRO_OFF_L	R/W	Yes	0x02	0x14	0x0000	Calibration, offset, y-axis gyroscope, low word	Table 63
YGYRO_OFF_H	R/W	Yes	0x02	0x16	0x0000	Calibration, offset, y-axis gyroscope, high word	Table 60
ZGYRO_OFF_L	R/W	Yes	0x02	0x18	0x0000	Calibration, offset, z-axis gyroscope, low word	Table 64
ZGYRO_OFF_H	R/W	Yes	0x02	0x1A	0x0000	Calibration, offset, z-axis gyroscope, high word	Table 61
XACCL_OFF_L	R/W	Yes	0x02	0x1C	0x0000	Calibration, offset, x-axis accelerometer, low word	Table 68
XACCL_OFF_H	R/W	Yes	0x02	0x1E	0x0000	Calibration, offset, x-axis accelerometer, high word	Table 65

Name	R/W	Flash	PAGE_ID	Address	Default	Register Description	Format
YACCL_OFF_L	R/W	Yes	0x02	0x20	0x0000	Calibration, offset, y-axis accelerometer, low word	Table 69
YACCL_OFF_H	R/W	Yes	0x02	0x22	0x0000	Calibration, offset, y-axis accelerometer, high word	Table 66
ZACCL_OFF_L	R/W	Yes	0x02	0x24	0x0000	Calibration, offset, z-axis accelerometer, low word	Table 70
ZACCL_OFF_H	R/W	Yes	0x02	0x26	0x0000	Calibration, offset, z-axis accelerometer, high word	Table 67
Reserved	N/A	N/A	0x02	0x28 to 0x3E	N/A	Reserved	N/A
XGYRO_SCL	R/W	Yes	0x02	0x40	0x0000	Calibration, scale, x-axis gyroscope	Table 71
YGYRO_SCL	R/W	Yes	0x02	0x42	0x0000	Calibration, scale, y-axis gyroscope	Table 72
ZGYRO_SCL	R/W	Yes	0x02	0x44	0x0000	Calibration, scale, z-axis gyroscope	Table 73
XACCL_SCL	R/W	Yes	0x02	0x46	0x0000	Calibration, scale, x-axis accelerometer	Table 74
YACCL_SCL	R/W	Yes	0x02	0x48	0x0000	Calibration, scale, y-axis accelerometer	Table 75
ZACCL_SCL	R/W	Yes	0x02	0x4A	0x0000	Calibration, scale, z-axis accelerometer	Table 76
Reserved	N/A	N/A	0x02	0x4C to 0x67	N/A	Reserved	N/A
SERIAL_NUM	R	Yes	0x02	0x68	N/A	Serial number	Table 48
Reserved	N/A	N/A	0x02	0x6A to 0x77	N/A	Reserved	N/A
FLSH_CNT_L	R	Yes	0x02	0x78	N/A	Diagnostic, flash memory write count, low word	Table 91
FLSH_CNT_H	R	Yes	0x02	0x7A	N/A	Diagnostic, flash memory write count, high word	Table 92
Reserved	N/A	N/A	0x02	0x7C to 0x7F	N/A	Reserved	N/A
PAGE_ID	R/W	No	0x03	0x00	0x0000	Page identifier	N/A
GLOB_CMD	W	No	0x03	0x02	N/A	Control, global commands	Table 90
Reserved	N/A	N/A	0x03	0x04	N/A	Reserved	N/A
FNCIO_CTRL	R/W	Yes	0x03	0x06	0x000D	Control, I/O pins, functional definitions	Table 93
GPIO_CTRL	R/W	Yes	0x03	0x08	0x0000	Control, I/O pins, general purpose	Table 94
GEN_CONFIG	R/W	Yes	0x03	0x0A	0x00C0	Control, clock and miscellaneous correction	Table 78
DEC_RATE	R/W	Yes	0x03	0x0C		Control, output sample rate decimation	Table 50
NULL_CFG	R/W	Yes	0x03	0x0E	0x070B	Control, automatic bias correction configuration	Table 77
SLP_CFG	R/W	No	0x03	0x10	N/A	Control, power-down/sleep mode	Table 95
Reserved	N/A	N/A	0x03	0x12 to 0x15	N/A	Reserved	N/A
FILTER_SEL1	R/W	Yes	0x03	0x16	0x0000	Filter selection	Table 51
FILTER_SEL2	R/W	Yes	0x03	0x18	0x0000	Filter selection	Table 52
Reserved	N/A	N/A	0x03	0x1A to 0x1F	N/A	Reserved	N/A
ALM_CONFIG_1	R/W	Yes	0x03	0x20	0x0000	Alarm configuration	Table 86
ALM_CONFIG_2	R/W	Yes	0x03	0x22	0x0000	Alarm configuration	Table 87
Reserved	N/A	N/A	0x03	0x24 to 0x3E	N/A	Reserved	N/A
XG_ALM_MAG	R/W	Yes	0x03	0x40	0x0000	X-axis gyroscope alarm trigger level	Table 80
YG_ALM_MAG	R/W	Yes	0x03	0x42	0x0000	Y-axis gyroscope alarm trigger level	Table 81
ZG_ALM_MAG	R/W	Yes	0x03	0x44	0x0000	Z-axis gyroscope alarm trigger level	Table 82
XA_ALM_MAG	R/W	Yes	0x03	0x46	0x0000	X-axis accelerometer alarm trigger level	Table 83
YA_ALM_MAG	R/W	Yes	0x03	0x48	0x0000	Y-axis accelerometer alarm trigger level	Table 84
ZA_ALM_MAG	R/W	Yes	0x03	0x4A	0x0000	Z-axis accelerometer alarm trigger level	Table 85
Reserved	N/A	N/A	0x03	0x4C to 0x7F	N/A	Reserved	N/A
Reserved	N/A	N/A	0x04	0x00 to 0x7F	N/A	Reserved	N/A
FIR_COEF_Axxx	R/W	Yes	0x05	0x00 to 0x7F	N/A	FIR Filter Bank A, Coefficients 1 through 60	Table 53
FIR_COEF_Axxx	R/W	Yes	0x06	0x00 to 0x7F	N/A	FIR Filter Bank A, Coefficients 61 through 120	Table 53
FIR_COEF_Bxxx	R/W	Yes	0x07	0x00 to 0x7F	N/A	FIR Filter Bank B, Coefficients 1 through 60	Table 54
FIR_COEF_Bxxx	R/W	Yes	0x08	0x00 to 0x7F	N/A	FIR Filter Bank B, Coefficients 61 through 120	Table 54
FIR_COEF_Cxxx	R/W	Yes	0x09	0x00 to 0x7F	N/A	FIR Filter Bank C, Coefficients 1 through 60	Table 55
FIR_COEF_Cxxx	R/W	Yes	0x0A	0x00 to 0x7F	N/A	FIR Filter Bank C, Coefficients 61 through 120	Table 55
FIR_COEF_Dxxx	R/W	Yes	0x0B	0x00 to 0x7F	N/A	FIR Filter Bank D, Coefficients 1 through 60	Table 56
FIR_COEF_Dxxx	R/W	Yes	0x0C	0x00 to 0x7F	N/A	FIR Filter Bank D, Coefficients 61 through 120	Table 56

OUTPUT DATA REGISTERS

After the ADIS16375 completes its startup process, the PAGE_ID register contains 0x0000, which sets Page 0 as the active page for SPI access. Page 0 contains the output data, real-time clock, status and product identification registers.

Table 10. Output Data Register Summary

Register	Address	Measurement
SYS_E_FLAG	0x08	System flags
DIAG_STS	0x0A	Self test flags
ALM_STS	0x0C	Alarm flags
TEMP_OUT	0x0E	Temperature
X_GYRO_LOW	0x10	Gyroscope, X
X_GYRO_OUT	0x12	Gyroscope, X
Y_GYRO_LOW	0x14	Gyroscope, Y
Y_GYRO_OUT	0x16	Gyroscope, Y
Z_GYRO_LOW	0x18	Gyroscope, Z
Z_GYRO_OUT	0x1A	Gyroscope, Z
X_ACCL_LOW	0x1C	Accelerometer, X
X_ACCL_OUT	0x1E	Accelerometer, X
Y_ACCL_LOW	0x20	Accelerometer, Y
Y_ACCL_OUT	0x22	Accelerometer, Y
Z_ACCL_LOW	0x24	Accelerometer, Z
Z_ACCL_OUT	0x26	Accelerometer, Z
X_DELTA_ANG_L	0x40	Delta angle, X
X_DELTA_ANG_H	0x42	Delta angle, X
Y_DELTA_ANG_L	0x44	Delta angle, Y
Y_DELTA_ANG_H	0x46	Delta angle, Y
Z_DELTA_ANG_L	0x48	Delta angle, Z
Z_DELTA_ANG_H	0x4A	Delta angle, Z
X_DELTA_VEL_L	0x4C	Delta velocity, X
X_DELTA_VEL_H	0x4E	Delta velocity, X
Y_DELTA_VEL_L	0x50	Delta velocity, Y
Y_DELTA_VEL_H	0x52	Delta velocity, Y
Z_DELTA_VEL_L	0x54	Delta velocity, Z
Z_DELTA_VEL_H	0x56	Delta velocity, Z
TIME_MS_OUT	0x70	Time, min, and sec
TIME_DH_OUT	0x72	Time, day, and hour
TIME_YM_OUT	0x74	Time, year, and month
LOT_ID1	0x78	Lot identifier
LOT_ID2	0x7A	Lot identifier
LOT_ID3	0x7C	Lot identifier
PROD_ID	0x7E	Product identifier

Inertial Sensor Data Format

The gyroscope, accelerometer, delta angle, and delta velocity output data use a 32-bit, twos complement format. Each output uses two registers to support this resolution. Figure 16 provides an example of how each register contributes to each inertial measurement. In this case, X_GYRO_OUT is the most significant word (upper 16 bits), and X_GYRO_LOW is the least significant word (lower 16 bits). In many cases, using the x_GYRO_OUT registers alone provides sufficient resolution for preserving key performance metrics.

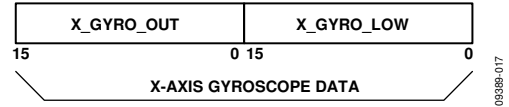

Figure 16. Gyroscope Output Format, DEC_RATE > 0

The arrows in Figure 17 describe the direction of the motion, which produces a positive output response in each sensor's output register. The accelerometers respond to both dynamic and static forces associated with acceleration, including gravity. When lying perfectly flat, as shown in Figure 17, the z-axis accelerometer output is 1 g, and the x and y accelerometers is 0 g.

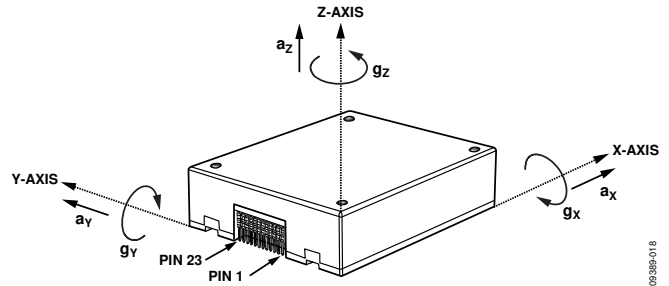

Figure 17. Inertial Sensor Direction Reference Diagram

Rotation Rate (Gyroscope)

The registers that use the x_GYRO_OUT format are the primary registers for the gyroscope measurements. When processing data from these registers, use a 16-bit, twos complement data format. Table 11, Table 12 and Table 13 provide each register's numerical format, and Table 14 provides x_GYRO_OUT digital coding examples.

Table 11. X_GYRO_OUT (Page 0, Base Address = 0x12)

Bits	Description
[15:0]	X-axis gyroscope data; twos complement, ±300°/sec range, 0.013108°/sec per LSB, 0°/sec = 0x0000

Table 12. Y_GYRO_OUT (Page 0, Base Address = 0x16)

Bits	Description
[15:0]	Y-axis gyroscope data; twos complement, ±300°/sec range, 0.013108°/sec per LSB, 0°/sec = 0x0000

Table 13. Z_GYRO_OUT (Page 0, Base Address = 0x1A)

Bits	Description
[15:0]	Z-axis gyroscope data; twos complement, ±300°/sec range, 0.013108°/sec per LSB, 0°/sec = 0x0000

Table 14. x_GYRO_OUT Data Format Examples

Rotation Rate	Decimal	Hex	Binary
+300°/sec	+22,887	0x5967	0101 1001 0110 0111
+0.026216°/sec	+2	0x0002	0000 0000 0000 0010
+0.013108°/sec	+1	0x0001	0000 0000 0000 0001
0°/sec	0	0x0000	0000 0000 0000 0000
-0.013108°/sec	-1	0xFFFF	1111 1111 1111 1111
-0.026216°/sec	-2	0xFFFE	1111 1111 1111 1110
-300°/sec	-22,887	0xA699	1010 0110 1001 1001

The registers that use the x_GYRO_LOW naming format provide additional resolution for the gyroscope measurements. The MSB has a weight of 0.006554°/sec, and each subsequent bit carries a weight of ½ of the previous one.

Table 15. X_GYRO_LOW (Page 0, Base Address = 0x10)

Bits	Description
[15:0]	X-axis gyroscope data; additional resolution bits

Table 16. Y_GYRO_LOW (Page 0, Base Address = 0x14)

Bits	Description
[15:0]	Y-axis gyroscope data; additional resolution bits

Table 17. Z_GYRO_LOW (Page 0, Base Address = 0x18)

Bits	Description
[15:0]	Z-axis gyroscope data; additional resolution bits

Acceleration

The registers that use the x_ACCL_OUT format are the primary registers for the accelerometer measurements. When processing data from these registers, use a 16-bit, twos complement data format. Table 18, Table 19 and Table 20 provide each register’s numerical format, and Table 21 provides x_ACCL_OUT digital coding examples.

Table 18. X_ACCL_OUT (Page 0, Base Address = 0x1E)

Bits	Description
[15:0]	X-axis accelerometer data; twos complement, ±18 g range, 0.8192 mg per LSB, 0 g = 0x0000

Table 19. Y_ACCL_OUT (Page 0, Base Address = 0x22)

Bits	Description
[15:0]	Y-axis accelerometer data; twos complement, ±18 g range, 0.8192 mg per LSB, 0 g = 0x0000

Table 20. Z_ACCL_OUT (Page 0, Base Address = 0x26)

Bits	Description
[15:0]	Z-axis accelerometer data; twos complement, ±18 g range, 0.8192 mg per LSB, 0 g = 0x0000

Table 21. x_ACCL_OUT Data Format Examples

Acceleration	Decimal	Hex	Binary
+18 g	+21,973	0x55D5	0101 0101 1101 0101
+1.6384 mg	+2	0x0002	0000 0000 0000 0010
+0.8192 mg	+1	0x0001	0000 0000 0000 0001
0 mg	0	0x0000	0000 0000 0000 0000
-0.8192 mg	-1	0xFFFF	1111 1111 1111 1111
-1.6384 mg	-2	0xFFFE	1111 1111 1111 1110
-18 g	-21,973	0xAA2B	1010 1010 0010 1011

The registers that use the x_ACCL_LOW naming format provide additional resolution for the accelerometer measurements. The MSB has a weight of 0.4096 mg, and each subsequent bit carries a weight of ½ of the previous one.

Table 22. X_ACCL_LOW (Page 0, Base Address = 0x1C)

Bits	Description
[15:0]	X-axis accelerometer data; additional resolution bits

Table 23. Y_ACCL_LOW (Page 0, Base Address = 0x20)

Bits	Description
[15:0]	Y-axis accelerometer data; additional resolution bits

Table 24. Z_ACCL_LOW (Page 0, Base Address = 0x24)

Bits	Description
[15:0]	Z-axis accelerometer data; additional resolution bits

Delta Angles

The delta angle outputs represent an integration of the gyroscope measurements and use the following formula for all three axes (x-axis displayed):

$$\Delta\theta_x = \frac{\Delta T_s}{2} \times (\omega_{x,n+1} + \omega_{x,n})$$

where:

ω_x is the gyroscope, x-axis.

ΔT_s is the time between samples.

$$\Delta T_s = \frac{DEC_RATE}{f_s}$$

When using the internal sample clock, f_s is equal to 2.46 kHz. When using the external clock option, the time between samples is the time between active edges on the input clock signal, as measured by the internal clock (252 MHz). See Table 50 for more information on the DEC_RATE register. The registers that use the x_DELTA_ANG_H format are the primary registers for the delta angle calculations. When processing data from these registers, use a 16-bit, twos complement data format. Table 25, Table 26, and Table 27 provide each register’s numerical format, and Table 28 provides several examples for converting digital data into angular degrees (°).

Table 25. X_DELTA_ANG_H (Page 0, Base Address = 0x42)

Bits	Description
[15:0]	X-axis delta angle data; twos complement, ±179.9891° range, sensitivity = 0.005493°/LSB, 0° = 0x0000

Table 26. Y_DELTA_ANG_H (Page 0, Base Address = 0x46)

Bits	Description
[15:0]	Y-axis delta angle data; twos complement, ±179.9891° range, sensitivity = 0.005493°/LSB, 0° = 0x0000

Table 27. Z_DELTA_ANG_H (Page 0, Base Address = 0x4A)

Bits	Description
[15:0]	Z-axis delta angle data; twos complement, ±179.9891° range, sensitivity = 0.005493°/LSB, 0° = 0x0000

Table 28. x_DELTA_ANG_H Data Format Examples

Angle	Decimal	Hex	Binary
+179.9891°	+32,767	0x7FFF	0111 1111 1110 1111
+0.010986°	+2	0x0002	0000 0000 0000 0010
+0.005493°	+1	0x0001	0000 0000 0000 0001
0°	0	0x0000	0000 0000 0000 0000
-0.005493°	-1	0xFFFF	1111 1111 1111 1111
-0.010986°	-2	0xFFFE	1111 1111 1111 1110
-180°	-32,768	0x8000	1000 0000 0000 0000

The registers that use the x_DELTA_ANG_L naming format provide additional resolution for the gyroscope measurements. The MSB has a weight of 0.0027465°, and each subsequent bit carries a weight of ½ of the previous one.

Table 29. X_DELTA_ANG_L (Page 0, Base Address = 0x40)

Bits	Description
[15:0]	X-axis delta angle data; additional resolution bits

Table 30. Y_DELTA_ANG_L (Page 0, Base Address = 0x44)

Bits	Description
[15:0]	Y-axis delta angle data; additional resolution bits

Table 31. Z_DELTA_ANG_L (Page 0, Base Address = 0x48)

Bits	Description
[15:0]	Z-axis delta angle data; additional resolution bits

Velocity Changes

The delta velocity outputs represent an integration of the accelerometer measurements and use the following formula for all three axes (x-axis displayed):

$$\Delta V_x = \frac{\Delta T_s}{2} \times (a_{x,n+1} + a_{x,n})$$

where:

α_x is the gyroscope, x-axis

ΔT_s is the time between samples.

$$\Delta T_s = \frac{DEC_RATE}{f_s}$$

When using the internal sample clock, f_s is equal to 2.46 kHz. When using the external clock option, the time between samples is the time between active edges on the input clock signal, as measured by the internal clock (252 MHz). See Table 50 for more information on the DEC_RATE register. The registers that use the x_DELTA_VEL_H format are the primary registers for the delta velocity calculations. When processing data from these registers, use a 16-bit, twos complement data format. Table 32, Table 33 and Table 34 provide the numerical format, and Table 35 provides digital coding examples.

Table 32. X_DELTA_VEL_H (Page 0, Base Address = 0x4E)

Bits	Description
[15:0]	X-axis delta velocity data; twos complement, ±99.998 m/sec, 3.0518 mm/sec per LSB, 0° = 0x0000

Table 33. Y_DELTA_VEL_H (Page 0, Base Address = 0x52)

Bits	Description
[15:0]	Y-axis delta velocity data; twos complement, ±99.998 m/sec, 3.0518 mm/sec per LSB, 0° = 0x0000

Table 34. Z_DELTA_VEL_H (Page 0, Base Address = 0x56)

Bits	Description
[15:0]	Z-axis delta velocity data; twos complement, ±99.998 m/sec, 3.0518 mm/sec per LSB, 0° = 0x0000

Table 35. x_DELTA_VEL_H, Data Format Examples

Velocity	Decimal	Hex	Binary
+99.998 m/sec	+32,767	0x7FFF	0111 1111 1111 1111
+6.1036 mm/sec	+2	0x0002	0000 0000 0000 0010
+3.0518 mm/sec	+1	0x0001	0000 0000 0000 0001
0 m/sec	0	0x0000	0000 0000 0000 0000
-3.0518 mm/sec	-1	0xFFFF	1111 1111 1111 1111
-6.1036 mm/sec	-2	0xFFFE	1111 1111 1111 1110
-100 m/sec	-32,768	0x8000	1000 0000 0000 0000

The registers that use the x_DELTA_VEL_L naming format provide additional resolution for the gyroscope measurements. The MSB has a weight of 1.5259 mm/sec, and each subsequent bit carries a weight of ½ of the previous one.

Table 36. X_DELTA_VEL_L (Page 0, Base Address = 0x4C)

Bits	Description
[15:0]	X-axis delta velocity data; additional resolution bits

Table 37. Y_DELTA_VEL_L (Page 0, Base Address = 0x50)

Bits	Description
[15:0]	Y-axis delta velocity data; additional resolution bits

Table 38. Z_DELTA_VEL_L (Page 0, Base Address = 0x54)

Bits	Description
[15:0]	Z-axis delta velocity data; additional resolution bits

Internal Temperature

The TEMP_OUT register provides an internal temperature measurement that can be useful for observing relative temperature changes in the environment (see Table 39). Table 40 provides several coding examples for converting the 16-bit twos complement number into units for temperature (°C).

Table 39. TEMP_OUT (Page 0, Base Address = 0x0E)

Bits	Description
[15:0]	Temperature data; twos complement, 0.00565°C per LSB, 25°C = 0x0000

Table 40. Temperature, Twos Complement Format

Temperature	Decimal	Hex	Binary
+85°C	+10,619	0x297B	0010 1001 0111 1011
+25+0.0113°C	+2	0x0002	0000 0000 0000 0010
+25+ 0.00565°C	+1	0x0001	0000 0000 0000 0001
+25°C	0	0x0000	0000 0000 0000 0000
+25°C-0.00565°C	-1	0xFFFF	1111 1111 1111 1111
+25°C-0.0113°C	-2	0xFFFE	1111 1111 1111 1110
-40°C	-11,504	0xD310	1101 0011 0001 0000

Status/Alarm Indicators

The SYS_E_FLAG register in Table 41 provides the system error flags.

Table 41. SYS_E_FLAG (Page 0, Base Address = 0x08)

Bits	Description
[15]	Watch dog timer flag (1 = timed out)
[14:8]	Not used
[7]	Processing overrun (1 = error)
[6]	Flash memory (1 = failure)
[5]	Inertial self test failure (1= DIAG_STS ≠ 0x00)
[4]	Sensor overrange (1 = at least one sensor overranged)
[3]	SPI communication error
[2:1]	Not used
[0]	Alarm status flag (1 = ALM_STS ≠ 0x00)

The DIAG_STS register in Table 42 provides the flags for the internal self test function.

Table 42. DIAG_STS (Page 0, Base Address = 0x0A)

Bits	Description
[15:6]	Not used
[5]	Self test failure, Z-axis accelerometer (1 = failure)
[4]	Self test failure, Y-axis accelerometer (1 = failure)
[3]	Self test failure, X-axis accelerometer (1 = failure)
[2]	Self test failure, Z-axis gyroscope (1 = failure)
[1]	Self test failure, Y-axis gyroscope (1 = failure)
[0]	Self test failure, X-axis gyroscope (1 = failure)

The ALM_STS register in Table 43 provides the alarm bits for each sensor's programmable alarm levels.

Table 43. ALM_STS (Page 0, Base Address = 0x0C)

Bits	Description
[15:6]	Not used
[5]	Z-axis accelerometer alarm flag (1 = alarm is active)
[4]	Y-axis accelerometer alarm flag (1 = alarm is active)
[3]	X-axis accelerometer alarm flag (1 = alarm is active)
[2]	Z-axis gyroscope alarm flag (1 = alarm is active)
[1]	Y-axis gyroscope alarm flag (1 = alarm is active)
[0]	X-axis gyroscope alarm flag (1 = alarm is active)

Product Identification

Table 44. LOT_ID1 (Page 0, Base Address = 0x78)

Bits	Description
[15:0]	Lot identification, binary code

Table 45. LOT_ID2 (Page 0, Base Address = 0x7A)

Bits	Description
[15:0]	Lot identification, binary code

Table 46. LOT_ID3 (Page 0, Base Address = 0x7C)

Bits	Description
[15:0]	Lot identification, binary code

Table 47. PROD_ID (Page 0, Base Address = 0x7E)

Bits	Description
[15:0]	Product identification = 0x3FF7

Table 48. SERIAL_NUM (Page 2, Base Address = 0x68)

Bits	Description
[15:0]	Lot-specific serial number

DIGITAL SIGNAL PROCESSING

Figure 18 provides a block diagram for the sampling and digital filter stages inside the ADIS16375. Table 49 provides a summary of the registers for sample rate and filter control.

Table 49. Digital Processing Registers

Register	Page	Address	Function
DEC_RATE	0x03	0x0C	Decimation rate
FILTER_SEL1	0x03	0x16	Filter selection
FILTER_SEL2	0x03	0x18	Filter selection
FIR_COEF_Axxx	0x05	0x08 to 0x7F	FIR Filter Bank A, 1 to 60
FIR_COEF_Axxx	0x06	0x08 to 0x7F	FIR Filter Bank A, 61 to 120
FIR_COEF_Bxxx	0x07	0x08 to 0x7F	FIR Filter Bank B, 1 to 60
FIR_COEF_Bxxx	0x08	0x08 to 0x7F	FIR Filter Bank B, 61 to 120
FIR_COEF_Cxxx	0x09	0x08 to 0x7F	FIR Filter Bank C, 1 to 60
FIR_COEF_Cxxx	0x0A	0x08 to 0x7F	FIR Filter Bank C, 61 to 120
FIR_COEF_Dxxx	0x0B	0x08 to 0x7F	FIR Filter Bank D, 1 to 60
FIR_COEF_Dxxx	0x0C	0x08 to 0x7F	FIR Filter Bank D, 61 to 120

SAMPLING PLAN

Figure 18 provides a signal flow diagram for all of the components and settings that influence the frequency response for each inertial sensor. The signal processing starts with sampling each inertial sensor at a rate of 9.84 kHz, followed by a divide-by-4 averaging/decimation filter stage.

AVERAGING/DECIMATION FILTER

The DEC_RATE register (see Table 50) provides user control for the final filter stage (see Figure 18), which averages and decimates the inertial sensor, delta angle and delta velocity data. This provides a simple method for reducing the rate of data updates in the output registers. For example, turn to Page 3 (DIN = 0x8003) and set DEC_RATE = 0x18 (DIN = 0x8C18, then DIN = 0x8D00) to reduce the output sample rate to 98.4 SPS (2460 ÷ 25).

Table 50. DEC_RATE (Page 3, Base Address = 0x0C)

Bits	Description (Default = 0x0000)
[15:11]	Don't care
[10:0]	Decimation rate, binary format, range: 0 to 2047

FIR FILTER BANKS

The ADIS16375 provides four configurable, 120-tap FIR filter banks. Each coefficient is 16-bits wide and occupies its own register location with each page. When designing a FIR filter for these banks, use a sample rate of 2.46 kHz and scale the coefficients so that their sum equals 32,768. For filter designs that have less than 120 taps, load the coefficients into the lower portion of the filter, start with Coefficient 1. Make sure that all unused taps are equal to zero so that they do not add phase delay to the response.

Table 51. FILTER_SEL1 (Page 3, Base Address = 0x16)

Bits	Description (Default = 0x0000)
[15]	Don't care
[14]	Y-axis accelerometer filter enable (1 = enabled)
[13:12]	Y-axis accelerometer filter bank selection: 00 = Bank A, 01 = Bank B, 10 = Bank C, 11 = Bank D
[11]	X-axis accelerometer filter enable (1 = enabled)
[10:9]	X-axis accelerometer filter bank selection: 00 = Bank A, 01 = Bank B, 10 = Bank C, 11 = Bank D
[8]	Z-axis gyroscope filter enable (1 = enabled)
[7:6]	Z-axis gyroscope filter bank selection: 00 = Bank A, 01 = Bank B, 10 = Bank C, 11 = Bank D
[5]	Y-axis gyroscope filter enable (1 = enabled)
[4:3]	Y-axis gyroscope filter bank selection: 00 = Bank A, 01 = Bank B, 10 = Bank C, 11 = Bank D
[2]	X-axis gyroscope filter enable (1 = enabled)
[1:0]	X-axis gyroscope filter bank selection: 00 = Bank A, 01 = Bank B, 10 = Bank C, 11 = Bank D

Table 52. FILTER_SEL2 (Page 3, Base Address = 0x18)

Bits	Description (Default = 0x0000)
[15:3]	Don't care
[2]	Z-axis accelerometer filter enable (1 = enabled)
[1:0]	Z-axis accelerometer filter bank selection: 00 = Bank A, 01 = Bank B, 10 = Bank C, 11 = Bank D

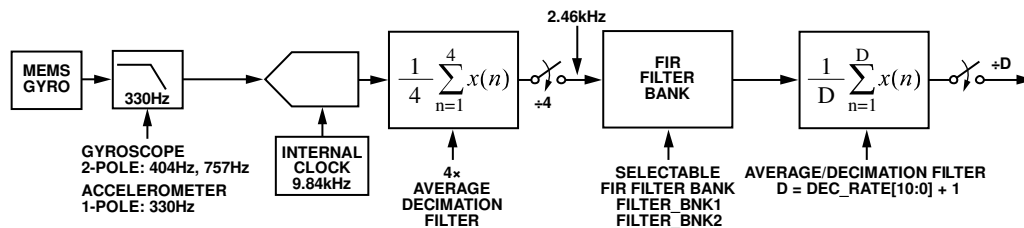

Figure 18. Sampling and Frequency Response Block Diagram

Filter Memory Organization

Each filter bank uses two pages of the user register structure. See Table 53, Table 54, Table 55, and Table 56 for the register addresses in each filter bank.

Table 53. Filter Bank A Memory Map

Page	PAGE_ID	Address	Register
5	0x05	0x00	PAGE_ID
5	0x05	0x02 to 0x07	Not used
5	0x05	0x08	FIR_COEF_A001
5	0x05	0x0A	FIR_COEF_A002
5	0x05	0x0C to 0x7C	FIR_COEF_A003 to FIR_COEF_A059
5	0x05	0x7E	FIR_COEF_A060
6	0x06	0x00	PAGE_ID
6	0x06	0x02 to 0x07	Not used
6	0x06	0x08	FIR_COEF_A061
6	0x06	0x0A	FIR_COEF_A062
6	0x06	0x0C to 0x7C	FIR_COEF_A063 to FIR_COEF_A119
6	0x06	0x7E	FIR_COEF_A120

Table 54. Filter Bank B Memory Map

Page	PAGE_ID	Address	Register
7	0x07	0x00	PAGE_ID
7	0x07	0x02 to 0x07	Not used
7	0x07	0x08	FIR_COEF_B001
7	0x07	0x0A	FIR_COEF_B002
7	0x07	0x0C to 0x7C	FIR_COEF_B003 to FIR_COEF_B059
7	0x07	0x7E	FIR_COEF_B060
8	0x08	0x00	PAGE_ID
8	0x08	0x02 to 0x07	Not used
8	0x08	0x08	FIR_COEF_B061
8	0x08	0x0A	FIR_COEF_B062
8	0x08	0x0C to 0x7C	FIR_COEF_B063 to FIR_COEF_B119
8	0x08	0x7E	FIR_COEF_B120

Table 55. Filter Bank C Memory Map

Page	PAGE_ID	Address	Register
9	0x09	0x00	PAGE_ID
9	0x09	0x02 to 0x07	Not used
9	0x09	0x08	FIR_COEF_C001
9	0x09	0x0A	FIR_COEF_C002
9	0x09	0x0C to 0x7C	FIR_COEF_C003 to FIR_COEF_C059
9	0x09	0x7E	FIR_COEF_C060
10	0x0A	0x00	PAGE_ID
10	0x0A	0x02 to 0x07	Not used
10	0x0A	0x08	FIR_COEF_C061
10	0x0A	0x0A	FIR_COEF_C062
10	0x0A	0x0C to 0x7C	FIR_COEF_C063 to FIR_COEF_C119
10	0x0A	0x7E	FIR_COEF_C120

Table 56. Filter Bank D Memory Map

Page	PAGE_ID	Address	Register
11	0x0B	0x00	PAGE_ID
11	0x0B	0x02 to 0x07	Not used
11	0x0B	0x08	FIR_COEF_D001
11	0x0B	0x0A	FIR_COEF_D002
11	0x0B	0x0C to 0x7C	FIR_COEF_D003 to FIR_COEF_D059
11	0x0B	0x7E	FIR_COEF_D060
12	0x0C	0x00	PAGE_ID
12	0x0C	0x02 to 0x07	Not used
12	0x0C	0x08	FIR_COEF_D061
12	0x0C	0x0A	FIR_COEF_D062
12	0x0C	0x0C to 0x7C	FIR_COEF_D063 to FIR_COEF_D119
12	0x0C	0x7E	FIR_COEF_D120

Default Filter Performance

The FIR filter banks have factory-programmed filter designs. They are all low-pass filters that have unity dc gain. Table 57 provides a summary of each filter design, and Figure 19 shows the frequency response characteristics. For more detailed analysis, read each coefficient into an array and analyze externally.

Table 57. FIR Filter Descriptions, Default Configuration

FIR Filter Bank	Taps	-3 dB Frequency (Hz)
A	120	310
B	120	55
C	32	275
D	32	63

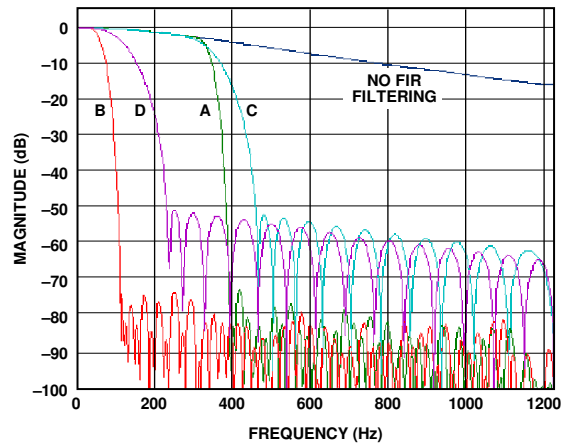

Figure 19. FIR Filter Frequency Response Curves

CALIBRATION

The ADIS16375 factory calibration produces correction formulas for each gyroscope and accelerometer, and then programs them into the flash memory. Table 58 contains a list of user control registers that provide opportunity for user optimization after installation. The bias and scale correction registers are in Page 2, and the control registers are in Page 3. Figure 20 illustrates an example of how the scale and offset registers for each sensor function.

Table 58. Registers for User Calibration

Register	Page	Address	Correction Function
XGYRO_OFF_L	2	0x10	Offset, X-axis gyroscope
XGYRO_OFF_H	2	0x12	Offset, X-axis gyroscope
YGYRO_OFF_L	2	0x14	Offset, Y-axis gyroscope
YGYRO_OFF_H	2	0x16	Offset, Y-axis gyroscope
ZGYRO_OFF_L	2	0x18	Offset, Z-axis gyroscope
ZGYRO_OFF_H	2	0x1A	Offset, Z-axis gyroscope
XACCL_OFF_L	2	0x1C	Offset, X-axis accelerometer
XACCL_OFF_H	2	0x1E	Offset, X-axis accelerometer
YACCL_OFF_L	2	0x20	Offset, Y-axis accelerometer
YACCL_OFF_H	2	0x22	Offset, Y-axis accelerometer
ZACCL_OFF_L	2	0x24	Offset, Z-axis accelerometer
ZACCL_OFF_H	2	0x26	Offset, Z-axis accelerometer
XGYRO_SCL	2	0x40	Scale, X-axis gyroscope
YGYRO_SCL	2	0x42	Scale, Y-axis gyroscope
ZGYRO_SCL	2	0x44	Scale, Z-axis gyroscope
XACCL_SCL	2	0x46	Scale, X-axis accelerometer
YACCL_SCL	2	0x48	Scale, Y-axis accelerometer
ZACCL_SCL	2	0x4A	Scale, Z-axis accelerometer
GEN_CONFIG	3	0x0A	Calibration configuration
NULL_CFG	3	0x0E	Bias-null configuration
GLOB_CMD	3	0x02	Calibration commands

The factory calibration addresses initial and temperature dependent bias errors in the gyroscopes, but some environmental conditions, such as temperature cycling and mechanical stress on the package, can cause bias shifts in MEMS gyroscope structures. For systems that value absolute bias accuracy, there are two options for optimizing absolute bias accuracy: autonull and manual correction.

Manual Bias Correction

The xGYRO_OFF_H (see Table 59, Table 60, and Table 61) and xGYRO_OFF_L (see Table 62, Table 63, and Table 64) registers provide a bias adjustment function for the output of each gyroscope sensor. The xGYRO_OFF_H registers use the same format as x_GYRO_OUT registers. The xGYRO_OFF_L registers use the same format as x_GYRO_LOW registers.

Table 59. XGYRO_OFF_H (Page 2, Base Address = 0x12)

Bits	Description (Default = 0x0000)
[15:0]	X-axis gyroscope offset correction, upper word; uses same format as X_GYRO_OUT (see Table 11)

Table 60. YGYRO_OFF_H (Page 2, Base Address = 0x16)

Bits	Description (Default = 0x0000)
[15:0]	Y-axis gyroscope offset correction, upper word; uses same format as Y_GYRO_OUT (see Table 12)

Table 61. ZGYRO_OFF_H (Page 2, Base Address = 0x1A)

Bits	Description (Default = 0x0000)
[15:0]	Z-axis gyroscope offset correction, upper word; uses same format as Z_GYRO_OUT (see Table 13)

Table 62. XGYRO_OFF_L (Page 2, Base Address = 0x10)

Bits	Description (Default = 0x0000)
[15:0]	X-axis gyroscope offset correction, lower word; uses same format as X_GYRO_LOW (see Table 15)

Table 63. YGYRO_OFF_L (Page 2, Base Address = 0x14)

Bits	Description (Default = 0x0000)
[15:0]	Y-axis gyroscope offset correction, lower word; uses same format as Y_GYRO_LOW (see Table 16)

Table 64. ZGYRO_OFF_L (Page 2, Base Address = 0x18)

Bits	Description (Default = 0x0000)
[15:0]	Z-axis gyroscope offset correction, lower word; uses same format as Z_GYRO_LOW (see Table 17)

The xACCL_OFF_H (see Table 65, Table 66, and Table 67) and xACCL_OFF_L (see Table 68, Table 69, and Table 70) registers provide a bias adjustment function for the output of each gyroscope sensor. The xACCL_OFF_H registers use the same format as x_ACCL_OUT registers. The xACCL_OFF_L registers use the same format as x_ACCL_LOW registers.

Table 65. XACCL_OFF_H (Page 2, Base Address = 0x1E)

Bits	Description (Default = 0x0000)
[15:0]	X-axis accelerometer offset correction, upper word; uses same format as X_ACCL_OUT (see Table 18)

Table 66. YACCL_OFF_H (Page 2, Base Address = 0x22)

Bits	Description (Default = 0x0000)
[15:0]	Y-axis accelerometer offset correction, upper word; uses same format as Y_ACCL_OUT (see Table 19)

Table 67. ZACCL_OFF_H (Page 2, Base Address = 0x26)

Bits	Description (Default = 0x0000)
[15:0]	Z-axis accelerometer offset correction, upper word; uses same format as Z_ACCL_OUT (see Table 20)

Table 68. XACCL_OFF_L (Page 2, Base Address = 0x1C)

Bits	Description (Default = 0x0000)
[15:0]	X-axis accelerometer offset correction, lower word; uses same format as X_ACCL_LOW (see Table 22)

Table 69. YACCL_OFF_L (Page 2, Base Address = 0x20)

Bits	Description (Default = 0x0000)
[15:0]	Y-axis accelerometer offset correction, lower word; uses same format as Y_ACCL_LOW (see Table 23)

Table 70. ZACCL_OFF_L (Page 2, Base Address = 0x24)

Bits	Description (Default = 0x0000)
[15:0]	Z-axis accelerometer offset correction, lower word; uses same format as Z_ACCL_LOW (see Table 24)

Manual Sensitivity Correction

The xGYRO_SCL and x_ACCL_SCL registers provide controls for sensitivity adjustment.

Table 71. XGYRO_SCL (Page 2, Base Address = 0x40)

Bits	Description (Default = 0x0000)
[15:0]	X-axis gyroscope scale correction; twos complement, 1 LSB = 0.003052% change in sensitivity; 0x0000 = no scale adjustment, unity gain

Table 72. YGYRO_SCL (Page 2, Base Address = 0x42)

Bits	Description (Default = 0x0000)
[15:0]	Y-axis gyroscope scale correction; twos complement, 1 LSB = 0.003052% change in sensitivity; 0x0000 = no scale adjustment, unity gain

Table 73. ZGYRO_SCL (Page 2, Base Address = 0x44)

Bits	Description (Default = 0x0000)
[15:0]	Z-axis gyroscope scale correction; twos complement, 1 LSB = 0.003052% change in sensitivity; 0x0000 = no scale adjustment, unity gain

Table 74. XACCL_SCL (Page 2, Base Address = 0x46)

Bits	Description (Default = 0x0000)
[15:0]	X-axis accelerometer scale correction; twos complement, 1 LSB = 0.003052% change in sensitivity; 0x0000 = no scale adjustment, unity gain

Table 75. YACCL_SCL (Page 2, Base Address = 0x48)

Bits	Description (Default = 0x0000)
[15:0]	Y-axis accelerometer scale correction; twos complement, 1 LSB = 0.003052% change in sensitivity; 0x0000 = no scale adjustment, unity gain

Table 76. ZACCL_SCL (Page 2, Base Address = 0x4A)

Bits	Description (Default = 0x0000)
[15:0]	Z-axis accelerometer scale correction; twos complement, 1 LSB = 0.003052% change in sensitivity; 0x0000 = no scale adjustment, unity gain

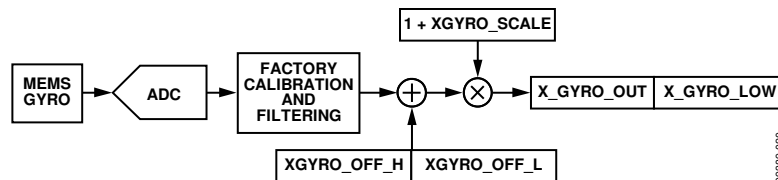

Figure 20. User Calibration Controls, X-Axis Gyroscope Example

053819-020

Bias Null Command

The continuous bias estimator (CBE) accumulates and averages data in a 64-sample FIFO. The average time (TA) for the bias estimates relies on the sample time base setting in NULL_CFG[7:0] (see Table 77). Users can load the correction factors of the CBE into the gyroscope offset correction registers (see Table 59, Table 60, Table 61, Table 62, Table 63, Table 64) using the bias null command in GLOB_CMD[0] (see Table 90). NULL_CFG[13:8] provide on/off controls for the sensors that update when issuing a bias null command. The factory-default configuration for NULL_CFG enables the bias null command for the gyroscopes, disables the bias null command for the accelerometers, and establishes the average time to 53.3 seconds.

Table 77. NULL_CFG (Page 3, Base Address = 0x0E)

Bits	Description (Default = 0x070B)
[15:14]	Not used
[13]	Z-axis acceleration bias correction enable (1 = enabled)
[12]	Y-axis acceleration bias correction enable (1 = enabled)
[11]	X-axis acceleration bias correction enable (1 = enabled)
[10]	Z-axis gyroscope bias correction enable (1 = enabled)
[9]	Y-axis gyroscope bias correction enable (1 = enabled)
[8]	X-axis gyroscope bias correction enable (1 = enabled)
[7:4]	Not used
[3:0]	Time base control (TC), range: 0 to 13 (default = 11); TB = 2 ^{TC} /2460, time base, TA = 64 × TB, average time

Turn to Page 3 (DIN = 0x8003) and set GLOB_CMD[0] = 1 (DIN = 0x8201, then DIN = 0x8300) to update the user offset registers with the correction factors of the CBE. Make sure that the inertial platform is stable during the entire average time for optimal bias estimates.

Restoring Factory Calibration

Turn to Page 3 (DIN = 0x8003) and set GLOB_CMD[6] = 1 (DIN = 0x8240, 0x8300) to execute the factory calibration restore function. This function resets each user calibration register to zero, resets all sensor data to 0, and automatically updates the flash memory within 72 ms. See Table 90 for more information on GLOB_CMD.

Linear Acceleration on Effect on Gyroscope Bias

MEMS gyroscopes typically have a bias response to linear acceleration that is normal to their axis of rotation. The ADIS16375 offers an optional compensation function for this effect. Turn to Page 3 (DIN = 0x8003) and set GEN_CONFIG[7] = 1 (DIN = 0x8A80, then DIN = 0x8B00). These example commands also disable the point of percussion. To enable this function as well, use DIN = 0x8AC0, 0x8B00. This function reduces the gyroscope bias response by a factor of at least 10.

Table 78. GEN_CONFIG (Page 3, Base Address = 0x0A)

Bits	Description (Default = 0x00C0)
[15:8]	Not used
[7]	Linear-g compensation for gyroscopes (1 = enabled)
[6]	Point of percussion alignment (1 = enabled)
[5:2]	Not used
[1]	Real-time clock, daylight savings time (1: enabled, 0: disabled)
[0]	Real-time clock control (1: relative/elapsed timer mode, 0: calendar mode)

Point of Percussion Alignment

GEN_CONFIG[6] offers a point of percussion alignment function that maps the accelerometer sensors to the corner of the package identified in Figure 21. To activate this feature, turn to Page 3 (DIN = 0x8003), then set GEN_CONFIG[6] = 1 (DIN = 0x8A40, 0x8B00). These example commands also disable the linear-g compensation. To enable this function as well, use DIN = 0x8AC0, 0x8B00.

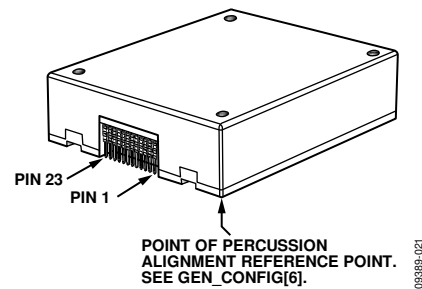

Figure 21. Point of Percussion Reference Point

ALARMS

The alarm function provides independent alarms for each inertial sensor. Table 79 contains a list of registers that provide configuration and control inputs for the alarm function.

Table 79. Registers for Alarm Configuration

Register	Page	Address	Description
ALM_CONFIG1	3	0x20	Alarm configuration
ALM_CONFIG2	3	0x22	Alarm configuration
XG_ALM_MAG	3	0x40	X-axis gyroscope trigger
YG_ALM_MAG	3	0x42	Y-axis gyroscope trigger
ZG_ALM_MAG	3	0x44	Z-axis gyroscope trigger
XA_ALM_MAG	3	0x46	X-axis accelerometer trigger
YA_ALM_MAG	3	0x48	Y-axis accelerometer trigger
ZA_ALM_MAG	3	0x4A	Z-axis accelerometer trigger

Static Alarm Use

The static alarm setting compares each sensor's output with the trigger settings in the xG_ALM_MAG and xA_ALM_MAG registers (see Table 80, Table 81, Table 82, Table 83, Table 84, and Table 85) of that sensor. The polarity controls for each alarm are in the ALM_CONFIG_x registers (see Table 86 and Table 87). The polarity establishes whether greater than or less than produces an alarm condition. The comparison between the xG_ALM_MAG (or xA_ALM_MAG) value and the output data only applies to the upper word or 16 bits of the output data.

Table 80. XG_ALM_MAG (Page 3, Base Address = 0x40)

Bits	Description (Default = 0x0000)
[15:0]	X-axis gyroscope alarm threshold settings; matches format of the X_GYRO_OUT register in Table 11

Table 81. YG_ALM_MAG (Page 3, Base Address = 0x42)

Bits	Description (Default = 0x0000)
[15:0]	Y-axis gyroscope alarm threshold settings; matches format of the Y_GYRO_OUT register in Table 12

Table 82. ZG_ALM_MAG (Page 3, Base Address = 0x44)

Bits	Description (Default = 0x0000)
[15:0]	Z-axis gyroscope alarm threshold settings; matches format of the Z_GYRO_OUT register in Table 13

Table 83. XA_ALM_MAG (Page 3, Base Address = 0x46)

Bits	Description (Default = 0x0000)
[15:0]	X-axis accelerometer alarm threshold settings; uses the same format as X_ACCL_OUT, see Table 18

Table 84. YA_ALM_MAG (Page 3, Base Address = 0x48)

Bits	Description (Default = 0x0000)
[15:0]	Y-axis accelerometer alarm threshold settings; uses the same format as Y_ACCL_OUT, see Table 19

Table 85. ZA_ALM_MAG (Page 3, Base Address = 0x4A)

Bits	Description (Default = 0x0000)
[15:0]	Z-axis accelerometer alarm threshold settings; uses the same format as Z_ACCL_OUT, see Table 20

Dynamic Alarm Use

The dynamic alarm setting provides the option of comparing the change in each sensor's output over a period of 48.7 ms, with that sensor's xx_ALM_MAG register.

Alarm Reporting

Monitor each sensor's alarm by reading the ALM_STS register (see Table 43), located in Page 0. The FNCIO_CTRL register (see Table 93) provides a control for establishing any of the DIOx lines as an alarm indicator output signal.

Table 86. ALM_CONFIG_1 (Page 3, Base Address = 0x20)

Bits	Description (Default = 0x0000)
[15]	X-axis accelerometer alarm (1 = enabled)
[14]	Not used
[13]	X-axis accelerometer alarm polarity (1 = greater than)
[12]	X-axis accelerometer dynamic enable (1 = enabled)
[11]	Z-axis gyroscope alarm (1 = enabled)
[10]	Not used
[9]	Z-axis gyroscope alarm polarity (1 = greater than)
[8]	Z-axis gyroscope dynamic enable (1 = enabled)
[7]	Y-axis gyroscope alarm (1 = enabled)
[6]	Not used
[5]	Y-axis gyroscope alarm polarity (1 = greater than)
[4]	Y-axis gyroscope dynamic enable (1 = enabled)
[3]	X-axis gyroscope alarm (1 = enabled)
[2]	Not used
[1]	X-axis gyroscope alarm polarity (1 = greater than)
[0]	X-axis gyroscope dynamic enable (1 = enabled)

Table 87. ALM_CONFIG_2 (Page 3, Base Address = 0x22)

Bits	Description (Default = 0x0000)
[15:8]	Not used
[7]	Z-axis accelerometer alarm (1 = enabled)
[6]	Not used
[5]	Z-axis accelerometer alarm polarity (1 = greater than)
[4]	Z-axis accelerometer dynamic enable (1 = enabled)
[3]	Y-axis accelerometer alarm (1 = enabled)
[2]	Not used
[1]	Y-axis accelerometer alarm polarity (1 = greater than)
[0]	Y-axis accelerometer dynamic enable (1 = enabled)

Alarm Example

Table 88 offers an alarm configuration example, which sets the X-axis gyroscope alarm to trip when X_GYRO_OUT > 131.1°/sec (0x2710).

Table 88. Alarm Configuration Example 1

DIN	Description
0xC010	Set XA_ALM_MAG[7:0] = 0x10
0xC127	Set XA_ALM_MAG[15:8] = 0x27
0xA006	Set ALM_CONFIG_1[7:0] = 0x06
0xA100	Set ALM_CONFIG_1[15:8] = 0x00

SYSTEM CONTROLS

The ADIS16375 provides a number of system-level controls for managing its operation using the registers listed in Table 89.

Table 89. System Control Registers

Register	Page	Address	Description
FLSH_CNT_L	2	0x78	Flash memory write counter
FLSH_CNT_H	2	0x7A	Flash memory write counter
GLOB_CMD	3	0x02	Global commands
FNCIO_CTRL	3	0x06	I/O Function control
GPIO_CTRL	3	0x08	I/O General purpose control
GEN_CONFIG	3	0x0A	Clock configuration
SLP_CONFIG	3	0x10	Sleep mode control

GLOBAL COMMANDS

The GLOB_CMD register (see Table 90) provides trigger bits for several operations. Write 1 to the appropriate bit in GLOB_CMD to start a function. After the function completes, the bit restores to 0.

Table 90. GLOB_CMD (Page 3, Base Address = 0x02)

Bits	Description	Execution Time
[15:8]	Not used	Not applicable
[7]	Software reset	74 ms
[6]	Factory calibration restore	50 ms
[5:4]	Not used	Not applicable
[3]	Flash memory update	375 ms
[2]	Flash memory test	50 ms
[1]	Self test	10 ms
[0]	Bias null	See Table 77

Software Reset

Turn to Page 3 (DIN = 0x8003) and then set GLOB_CMD[7] = 1 (DIN = 0x8280, then DIN = 0x8300) to reset the operation, which removes all data, initializes all registers from their flash settings, and starts data collection. This function provides a firmware alternative to the $\overline{\text{RST}}$ line (see Table 5, Pin 8).

Automatic Self Test

Turn to Page 3 (DIN = 0x8003) and then set GLOB_CMD[1] = 1 (DIN = 0x8202, then DIN = 0x8300) to run an automatic self test routine, which executes the following steps:

1. Measure output on each sensor
2. Activate self test on each sensor
3. Measure output on each sensor
4. Deactivate the self test on each sensor
5. Calculate the difference with self test on and off
6. Compare the difference with internal pass/fail criteria
7. Report the pass/fail results for each sensor in DIAG_STS (see Table 42)

After waiting 10 ms for this test to complete, turn to Page 0 (DIN = 0x8000) and read DIAG_STS using DIN = 0x0A00. Note that using an external clock can extend this time. When using an external clock of 100 Hz, this time extends to 35 ms. Note that 100 Hz is too slow for optimal sensor performance; however, it demonstrates the potential for longer self test times.

MEMORY MANAGEMENT

The data retention of the flash memory depends on temperature and the number of write cycles. Figure 22 characterizes the dependence on temperature and the FLSH_CNT_L (see Table 91) and FLSH_CNT_H (see Table 92) registers provide a running count of flash write cycles. The flash updates every time GLOB_CMD[6], GLOB_CMD[3], or GLOB_CMD[0] is set to 1.

Table 91. FLSH_CNT_L (Page 2, Base Address = 0x78)

Bits	Description
[15:0]	Binary counter; number of flash updates, lower word

Table 92. FLSH_CNT_H (Page 2, Base Address = 0x7A)

Bits	Description
[15:0]	Binary counter; number of flash updates, upper word

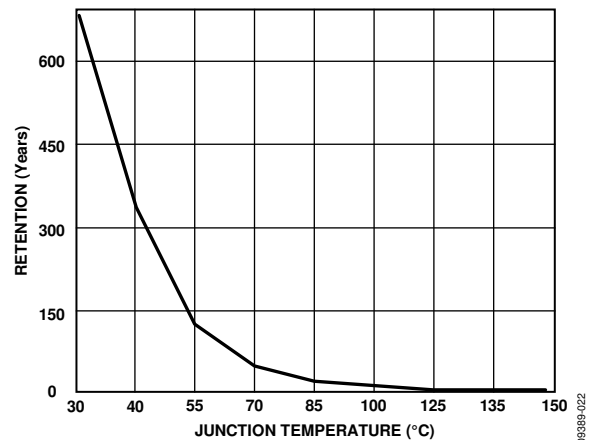

Figure 22. Flash Memory Retention

Flash Memory Test

Turn to Page 3 (DIN = 0x8003), and then set GLOB_CMD[2] = 1 (DIN = 0x8204, then DIN = 0x8300) to run a check-sum test of the internal flash memory, which compares a factory-programmed sum with the current sum of the same memory locations. The result of this test loads into SYS_E_FLAG[6] (see Table 41). Read this register by turning to Page 0 (DIN = 0x8000) and using DIN = 0x0800 as the read request command.

GENERAL-PURPOSE I/O

There are four general-purpose I/O lines: DIO1, DIO2, DIO3, and DIO4. The FNCIO_CTRL register controls the basic function of each I/O line, which provides a number of useful functions.

Table 93. FNCIO_CTRL (Page 3, Base Address = 0x06)

Bits	Description (Default = 0x000D)
[15:12]	Not used
[11]	Alarm indicator: 1 = enabled, 0 = disabled
[10]	Alarm indicator polarity: 1 = positive, 0 = negative
[9:8]	Alarm indicator line selection: 00 = DIO1, 01 = DIO2, 10 = DIO3, 11 = DIO4
[7]	Sync clock input enable: 1 = enabled, 0 = disabled
[6]	Sync clock input polarity: 1 = rising edge, 0 = falling edge
[5:4]	Sync clock input line selection: 00 = DIO1, 01 = DIO2, 10 = DIO3, 11 = DIO4
[3]	Data-ready enable: 1 = enabled, 0 = disabled
[2]	Data-ready polarity: 1 = positive, 0 = negative
[1:0]	Data-ready line selection: 00 = DIO1, 01 = DIO2, 10 = DIO3, 11 = DIO4

Data-Ready Indicator

FNCIO_CTRL[3:0] provide some configuration options for using one of the DIOx lines as a data-ready indicator signal, which can drive a processor's interrupt control line. The factory-default assigns DIO2 as a positive-polarity, data-ready signal. Use the following sequence to change this assignment to DIO1 with a negative polarity: turn to Page 3 (DIN = 0x8003) and set FNCIO_CTRL[3:0] = 1000 (DIN = 0x8608, then DIN = 0x8700). The timing jitter on the data-ready signal is $\pm 1.4 \mu\text{s}$.

Input Sync/Clock Control

FNCIO_CTRL[7:4] provides some configuration options for using one of the DIOx lines as an input synchronization signal for sampling inertial sensor data. For example, use the following sequence to establish DIO4 as a positive-polarity, input clock pin and keep the factory default setting for the data-ready function: turn to Page 3 (DIN = 0x8003) and set FNCIO_CTRL[7:4] = 1111 (DIN = 0x86FD, then DIN = 0x8700). Note that this command also disables the internal sampling clock, and no data sampling takes place without the input clock signal. When using this mode, each clock pulse generates four sequential samples at a rate of 9.84 kHz, which are then averaged together. When selecting a clock input frequency, consider the 330 Hz sensor bandwidth, because undersampling the sensors can degrade noise and stability performance.

General-Purpose I/O Control

When FNCIO_CTRL does not configure a DIOx pin, the GPIO_CTRL provides a control register for general-purpose use of the pins. GPIO_CTRL[3:0] provides input/output assignment controls for each line. When the DIOx lines are inputs, monitor their level by reading GPIO_CTRL[7:4]. When the DIOx lines are used as outputs, set their level by writing to GPIO_CTRL[7:4]. For example, use the following sequence to set DIO1 and DIO3 as high and low output lines, respectively, and set DIO2 and

DIO4 as input lines. Turn to Page 3 (DIN = 0x8003) and set GPIO_CTRL[7:0] = 0x15 (DIN = 0x8815, then DIN = 0x8900).

Table 94. GPIO_CTRL (Page 3, Base Address = 0x08)

Bits	Description (Default = 0x0000)
[15:8]	Don't care
[7]	General-Purpose I/O Line 4 (DIO4) data level
[6]	General-Purpose I/O Line 3 (DIO3) data level
[5]	General-Purpose I/O Line 2 (DIO2) data level
[4]	General-Purpose I/O Line 1 (DIO1) data level
[3]	General-Purpose I/O Line 4 (DIO4) direction control (1 = output, 0 = input)
[2]	General-Purpose I/O Line 3 (DIO3) direction control (1 = output, 0 = input)
[1]	General-Purpose I/O Line 2 (DIO2) direction control (1 = output, 0 = input)
[0]	General-Purpose I/O Line 1 (DIO1) direction control (1 = output, 0 = input)

POWER MANAGEMENT

The SLP_CFG register (see Table 95) provides four different power management modes for system-level management: power-down, timed power-down, normal sleep, and timed sleep. The trade-off between power-down and sleep mode is between idle power and recovery time. Power-down mode offers the best idle power consumption but requires the most time to recover. All volatile settings are lost during power-down but are preserved during sleep mode.

For timed sleep mode, turn to Page 3 (DIN = 0x8003), write the amount of sleep time to SLP_CFG[7:0], and set SLP_CFG[8] = 1 (DIN = 0x9101) to start the sleep period. For a timed power-down period, change the last command to set SLP_CFG[9] = 1 (DIN = 0x9102). To power down or sleep for an indefinite period, set SLP_CFG[7:0] = 0x00 first, then set either SLP_CFG[8] or SLP_CFG[9] to 1. Note that the command takes effect when the $\overline{\text{CS}}$ line goes high. To awaken the device from sleep or power-down mode, use one of the following options to restore normal operation:

- Assert $\overline{\text{CS}}$ from high to low
- Pulse $\overline{\text{RST}}$ low, then high again
- Cycle the power

For example, set SLP_CFG[7:0] = 0x64 (DIN = 0x9064), then set SLP_CFG[8] = 1 (DIN = 0x9101) to start a sleep period of 100 seconds.

Table 95. SLP_CFG (Page 3, Base Address = 0x10)

Bits	Description
[15:10]	Not used
[9]	Power-down mode
[8]	Normal sleep mode
[7:0]	Programmable sleep time bits; 1 sec/LSB; 0x00 = indefinite

If the sleep mode and power-down mode bits are both set high, then the sleep mode (SLP_CFG[8]) bit take precedence.