



Chipsmall Limited consists of a professional team with an average of over 10 year of expertise in the distribution of electronic components. Based in Hongkong, we have already established firm and mutual-benefit business relationships with customers from,Europe,America and south Asia,supplying obsolete and hard-to-find components to meet their specific needs.

With the principle of “Quality Parts,Customers Priority,Honest Operation,and Considerate Service”,our business mainly focus on the distribution of electronic components. Line cards we deal with include Microchip,ALPS,ROHM,Xilinx,Pulse,ON,Everlight and Freescale. Main products comprise IC,Modules,Potentiometer,IC Socket,Relay,Connector.Our parts cover such applications as commercial,industrial, and automotives areas.

We are looking forward to setting up business relationship with you and hope to provide you with the best service and solution. Let us make a better world for our industry!



## Contact us

Tel: +86-755-8981 8866 Fax: +86-755-8427 6832

Email & Skype: info@chipsmall.com Web: www.chipsmall.com

Address: A1208, Overseas Decoration Building, #122 Zhenhua RD., Futian, Shenzhen, China



### FEATURES

Frequency ranges of 2200 MHz to 2700 MHz (RF) and 30 MHz to 450 MHz (IF)

Power conversion gain: 8.7 dB

Input IP3 of 24.5 dBm and Input P1dB of 10.4 dBm

SSB noise figure of 9.8 dB

Typical LO drive of 0 dBm

Single-ended, 50 Ω RF and LO input ports

High isolation SPDT LO input switch

Single-supply operation: 3.3 V to 5 V

Exposed pad, 5 mm × 5 mm 20-lead LFCSP

1500 V HBM/500 V FICDM ESD performance

### APPLICATIONS

Cellular base station receivers

Transmit observation receivers

Radio link downconverters

### GENERAL DESCRIPTION

The **ADL5353** uses a highly linear, doubly balanced passive mixer core along with integrated RF and local oscillator (LO) balancing circuitry to allow for single-ended operation. The **ADL5353** incorporates an RF balun to provide optimal performance over a 2200 MHz to 2700 MHz input frequency range using high-side LO. The balanced passive mixer arrangement provides good LO-to-RF leakage, typically better than -36 dBm, and excellent intermodulation performance.

The balanced mixer core also provides extremely high input linearity, allowing the device to be used in demanding cellular applications where in-band blocking signals might otherwise result in the degradation of dynamic performance. A high linearity IF buffer amplifier follows the passive mixer core to yield a typical power conversion gain of 8.8 dB and can be used with a wide range of output impedances.

### FUNCTIONAL BLOCK DIAGRAM

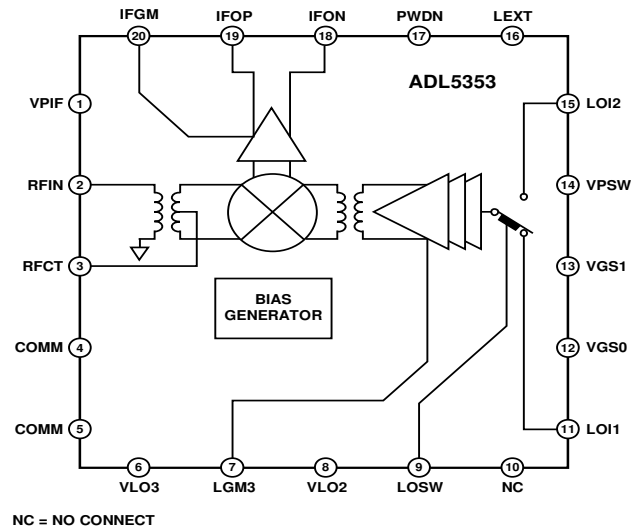

Figure 1.

The **ADL5353** provides two switched LO paths that can be used in TDD applications where it is desirable to rapidly switch between two local oscillators. LO current can be externally set using a resistor to minimize dc current commensurate with the desired level of performance. For low voltage applications, the **ADL5353** is capable of operation at voltages down to 3.3 V with substantially reduced current. For low voltage operation, an additional logic pin is provided to power down (<200 μA) the circuit when desired.

The **ADL5353** is fabricated using a BiCMOS high performance IC process. The device is available in a 5 mm × 5 mm, 20-lead LFCSP and operates over a -40°C to +85°C temperature range. An evaluation board is also available.

Table 1. Passive Mixers

RF Frequency (MHz)	Single Mixer	Single Mixer and IF Amp	Dual Mixer and IF Amp
500 to 1700	<a href="#">ADL5367</a>	<a href="#">ADL5357</a>	<a href="#">ADL5358</a>
1200 to 2500	<a href="#">ADL5365</a>	<a href="#">ADL5355</a>	<a href="#">ADL5356</a>
2300 to 2900	<a href="#">ADL5363</a>	<a href="#">ADL5353</a>	<a href="#">ADL5354</a>

# ADL5353\* PRODUCT PAGE QUICK LINKS

Last Content Update: 02/23/2017

---

## COMPARABLE PARTS

View a parametric search of comparable parts.

## EVALUATION KITS

- ADL5353 Evaluation Board

## DOCUMENTATION

### Data Sheet

- ADL5353: 2200 MHz to 2700 MHz Balanced Mixer, LO Buffer, IF Amplifier, and RF Balun Data Sheet

## TOOLS AND SIMULATIONS

- ADIsimPLL™
- ADIsimRF

## REFERENCE MATERIALS

### Product Selection Guide

- RF Source Booklet

## DESIGN RESOURCES

- ADL5353 Material Declaration
- PCN-PDN Information
- Quality And Reliability
- Symbols and Footprints

## DISCUSSIONS

View all ADL5353 EngineerZone Discussions.

## SAMPLE AND BUY

Visit the product page to see pricing options.

## TECHNICAL SUPPORT

Submit a technical question or find your regional support number.

## DOCUMENT FEEDBACK

Submit feedback for this data sheet.

---

## TABLE OF CONTENTS

Features .....	1	SPUR TABLES .....	15
Applications.....	1	Spur Tables .....	15
General Description .....	1	Circuit Description.....	16
Functional Block Diagram .....	1	RF Subsystem .....	16
Revision History .....	2	LO Subsystem .....	16
Specifications.....	3	Applications Information .....	18
5 V Performance Specifications.....	3	Basic Connections.....	18
3.3 V Performance Specifications.....	4	Bias Resistor Selection .....	18
Absolute Maximum Ratings.....	5	Mixer VGS Control DAC .....	18
ESD Caution.....	5	Evaluation Board .....	19
Pin Configuration and Function Descriptions.....	6	Outline Dimensions .....	22
Typical Performance Characteristics .....	7	Ordering Guide .....	22
5 V Performance .....	7		
3.3 V Performance.....	14		

## REVISION HISTORY

### 2/15—Rev. 0 to Rev. A

Changes to Table 1 .....	1
Deleted R9 from 5 V Performance Section.....	7
Deleted Figure 41; Renumbered Sequentially.....	13
Changes to Figure 41 .....	13
Changes to Figure 51 .....	19
Changes to Table 7.....	20
Updated Outline Dimensions .....	22
Changes to Ordering Guide .....	22

### 10/10—Revision 0: Initial Version

## SPECIFICATIONS

### 5 V PERFORMANCE SPECIFICATIONS

#### RF Interface

$V_S = 5\text{ V}$ ,  $I_S = 190\text{ mA}$ ,  $T_A = 25^\circ\text{C}$ ,  $f_{RF} = 2535\text{ MHz}$ ,  $f_{LO} = 2738\text{ MHz}$ , LO power = 0 dBm,  $Z_O = 50\ \Omega$ , unless otherwise noted.

Table 2.

Parameter	Test Conditions/Comments	Min	Typ	Max	Unit
<b>RF INPUT INTERFACE</b>					
Return Loss	Tunable to >20 dB over a limited bandwidth		18		dB
Input Impedance			50		$\Omega$
RF Frequency Range		2200		2700	MHz
<b>OUTPUT INTERFACE</b>					
Output Impedance	Differential impedance, $f = 200\text{ MHz}$		230  1.5		$\Omega$   pF
IF Frequency Range		30		450	MHz
DC Bias Voltage <sup>1</sup>	Externally generated	3.3	5.0	5.5	V
<b>LO INTERFACE</b>					
LO Power		-6	0	+10	dBm
Return Loss			15		dB
Input Impedance			50		$\Omega$
LO Frequency Range		2230		3150	MHz
<b>POWER-DOWN (PWDN) INTERFACE<sup>2</sup></b>					
PWDN Threshold			1.0		V
Logic 0 Level				0.4	V
Logic 1 Level		1.4			V
PWDN Response Time	Device enabled, IF output to 90% of its final level		160		ns
	Device disabled, supply current <5 mA		220		ns
PWDN Input Bias Current	Device enabled		0.0		$\mu\text{A}$
	Device disabled		70		$\mu\text{A}$

<sup>1</sup> Apply the supply voltage from the external circuit through the choke inductors.

<sup>2</sup> The power-down function is intended for use with  $V_S \leq 3.6\text{ V}$  only.

**RF Dynamic Performance**

$V_S = 5\text{ V}$ ,  $I_S = 190\text{ mA}$ ,  $T_A = 25^\circ\text{C}$ ,  $f_{RF} = 2535\text{ MHz}$ ,  $f_{LO} = 2738\text{ MHz}$ , LO power = 0 dBm,  $V_{GS0} = V_{GS1} = 0\text{ V}$ , and  $Z_O = 50\ \Omega$ , unless otherwise noted.

Table 3.

Parameter	Test Conditions/Comments	Min	Typ	Max	Unit
<b>DYNAMIC PERFORMANCE</b>					
Power Conversion Gain	Including 4:1 IF port transformer and PCB loss		8.7		dB
Voltage Conversion Gain	$Z_{SOURCE} = 50\ \Omega$ , differential $Z_{LOAD} = 200\ \Omega$ differential		14.7		dB
SSB Noise Figure			9.8		dB
Input Third-Order Intercept (IIP3)	$f_{RF1} = 2534.5\text{ MHz}$ , $f_{RF2} = 2535.5\text{ MHz}$ , $f_{LO} = 2738\text{ MHz}$ , each RF tone at $-10\text{ dBm}$	21	24.5		dBm
Input Second-Order Intercept (IIP2)	$f_{RF1} = 2535\text{ MHz}$ , $f_{RF2} = 2585\text{ MHz}$ , $f_{LO} = 2738\text{ MHz}$ , each RF tone at $-10\text{ dBm}$		47.5		dBm
Input 1 dB Compression Point (IP1dB)			10.4		dBm
LO-to-IF Leakage	Unfiltered IF output		-15		dBm
LO-to-RF Leakage			-38		dBm
RF-to-IF Isolation			-28		dBc
IF/2 Spurious	$-10\text{ dBm}$ input power		-70		dBc
IF/3 Spurious	$-10\text{ dBm}$ input power		-78		dBc
<b>POWER SUPPLY</b>					
Positive Supply Voltage		4.5	5.0	5.5	V
Quiescent Current	LO supply, resistor programmable		100		mA
	IF supply, resistor programmable		90		mA
Total Quiescent Current	$V_S = 5\text{ V}$		190		mA

**3.3 V PERFORMANCE SPECIFICATIONS**

$V_S = 3.3\text{ V}$ ,  $I_S = 125\text{ mA}$ ,  $T_A = 25^\circ\text{C}$ ,  $f_{RF} = 2535\text{ MHz}$ ,  $f_{LO} = 2738\text{ MHz}$ , LO power = 0 dBm,  $R_9 = 226\ \Omega$ ,  $R_{14} = 604\ \Omega$ ,  $V_{GS0} = V_{GS1} = 0\text{ V}$ , and  $Z_O = 50\ \Omega$ , unless otherwise noted.

Table 4.

Parameter	Test Conditions/Comments	Min	Typ	Max	Unit
<b>DYNAMIC PERFORMANCE</b>					
Power Conversion Gain	Including 4:1 IF port transformer and PCB loss		9		dB
Voltage Conversion Gain	$Z_{SOURCE} = 50\ \Omega$ , differential $Z_{LOAD} = 200\ \Omega$ differential		15		dB
SSB Noise Figure			8.95		dB
Input Third-Order Intercept (IIP3)	$f_{RF1} = 2534.5\text{ MHz}$ , $f_{RF2} = 2535.5\text{ MHz}$ , $f_{LO} = 2738\text{ MHz}$ , each RF tone at $-10\text{ dBm}$		19		dBm
Input Second-Order Intercept (IIP2)	$f_{RF1} = 2535\text{ MHz}$ , $f_{RF2} = 2585\text{ MHz}$ , $f_{LO} = 2738\text{ MHz}$ , each RF tone at $-10\text{ dBm}$		41.5		dBm
Input 1 dB Compression Point (IP1dB)			7.5		dBm
<b>POWER INTERFACE</b>					
Supply Voltage		3.0	3.3	3.6	V
Quiescent Current	Resistor programmable		125		mA
Power-Down Current	Device disabled		150		$\mu\text{A}$

## ABSOLUTE MAXIMUM RATINGS

Table 5.

Parameter	Rating
Supply Voltage, $V_S$	5.5 V
RF Input Level	20 dBm
LO Input Level	13 dBm
IFOP, IFON Bias Voltage	6.0 V
VGS0, VGS1, LOSW, PWDN	5.5 V
Internal Power Dissipation	1.2 W
Thermal Resistance, $\theta_{JA}$	25°C/W
Temperature	
Maximum Junction Temperature	150°C
Operating Temperature Range	-40°C to +85°C
Storage Temperature Range	-65°C to +150°C
Lead Temperature (Soldering, 60 sec)	260°C

Stresses at or above those listed under Absolute Maximum Ratings may cause permanent damage to the product. This is a stress rating only; functional operation of the product at these or any other conditions above those indicated in the operational section of this specification is not implied. Operation beyond the maximum operating conditions for extended periods may affect product reliability.

### ESD CAUTION



**ESD (electrostatic discharge) sensitive device.** Charged devices and circuit boards can discharge without detection. Although this product features patented or proprietary protection circuitry, damage may occur on devices subjected to high energy ESD. Therefore, proper ESD precautions should be taken to avoid performance degradation or loss of functionality.

## PIN CONFIGURATION AND FUNCTION DESCRIPTIONS

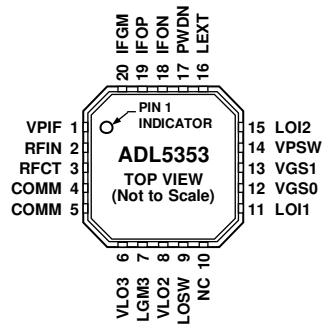

- NOTES
1. NC = NO CONNECT.
  2. EXPOSED PAD. MUST BE SOLDERED TO GROUND.

09117-002

Figure 2. Pin Configuration

Table 6. Pin Function Descriptions

Pin No.	Mnemonic	Description
1	VPIF	Positive Supply Voltage for IF Amplifier.
2	RFIN	RF Input. Must be ac-coupled.
3	RFCT	RF Balun Center Tap (AC Ground).
4, 5	COMM	Device Common (DC Ground).
6, 8	VLO3, VLO2	Positive Supply Voltages for LO Amplifier.
7	LGM3	LO Amplifier Bias Control.
9	LOSW	LO Switch. LOI1 selected for 0 V, and LOI2 selected for 3 V.
10	NC	No Connect.
11, 15	LOI1, LOI2	LO Inputs. Must be ac-coupled.
12, 13	VGS0, VGS1	Mixer Gate Bias Controls. 3 V logic. Ground these pins for nominal setting.
14	VPSW	Positive Supply Voltage for LO Switch.
16	LEXT	IF Return. This pin must be grounded.
17	PWDN	Power Down. Connect this pin to ground for normal operation and connect this pin to 3.0 V for disable mode.
18, 19	IFON, IFOP	Differential IF Outputs (Open Collectors). Each requires an external dc bias.
20	IFGM	IF Amplifier Bias Control.
	EPAD (EP)	Exposed Pad. The exposed pad must be soldered to ground.



# TYPICAL PERFORMANCE CHARACTERISTICS

## 5 V PERFORMANCE

$V_S = 5\text{ V}$ ,  $I_S = 190\text{ mA}$ ,  $T_A = 25^\circ\text{C}$ ,  $f_{RF} = 2535\text{ MHz}$ ,  $f_{LO} = 2738\text{ MHz}$ , LO power = 0 dBm,  $R_{14} = 910\ \Omega$ ,  $V_{GS0} = V_{GS1} = 0\text{ V}$ , and  $Z_O = 50\ \Omega$ , unless otherwise noted.

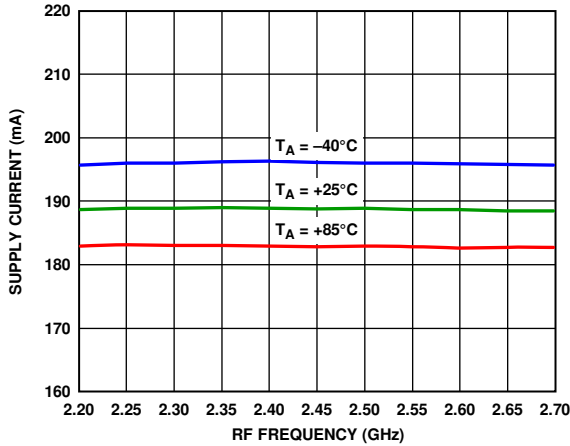

Figure 3. Supply Current vs. RF Frequency

09117-003

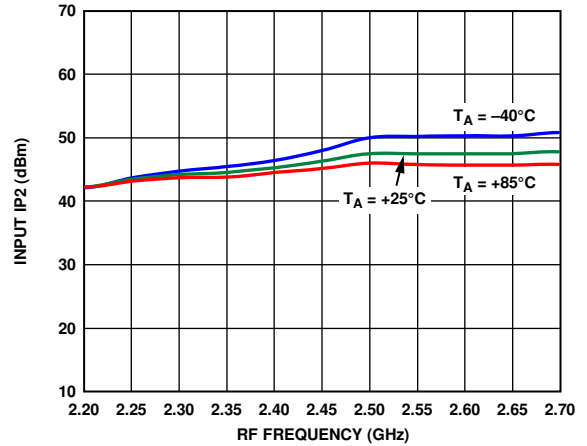

Figure 6. Input IP2 vs. RF Frequency

09117-006

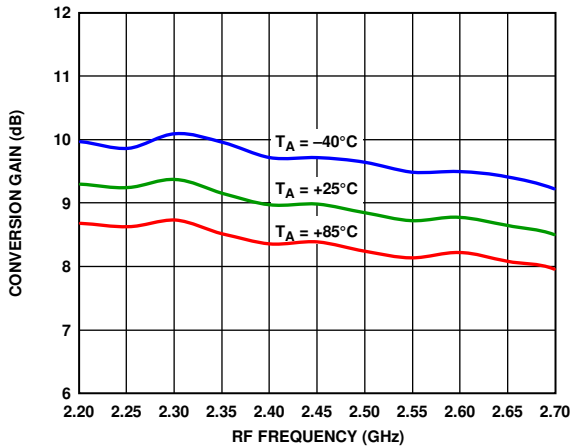

Figure 4. Power Conversion Gain vs. RF Frequency

09117-004

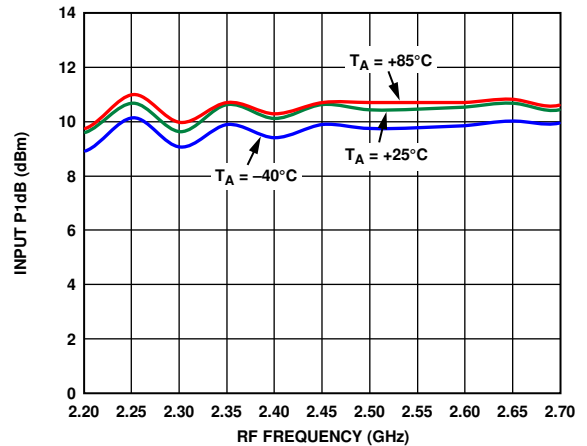

Figure 7. Input P1dB vs. RF Frequency

09117-007

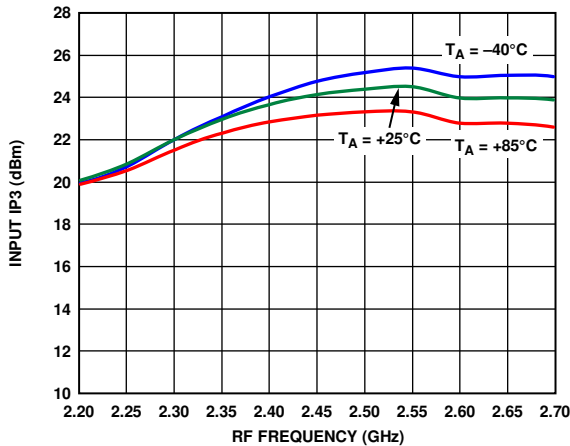

Figure 5. Input IP3 vs. RF Frequency

09117-005

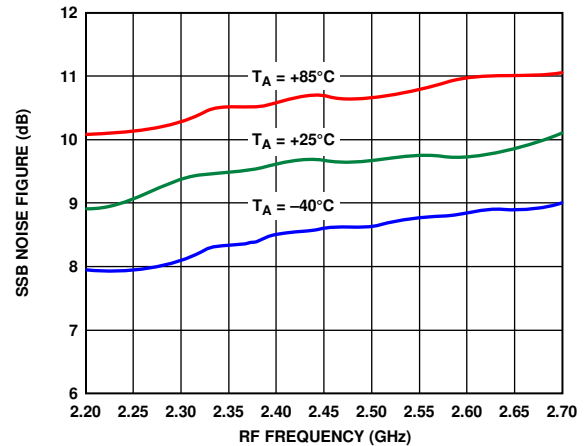

Figure 8. SSB Noise Figure vs. RF Frequency

09117-008

$V_S = 5\text{ V}$ ,  $I_S = 190\text{ mA}$ ,  $T_A = 25^\circ\text{C}$ ,  $f_{RF} = 2535\text{ MHz}$ ,  $f_{LO} = 2738\text{ MHz}$ , LO power = 0 dBm,  $R_{14} = 910\ \Omega$ ,  $V_{GS0} = V_{GS1} = 0\text{ V}$ , and  $Z_O = 50\ \Omega$ , unless otherwise noted.

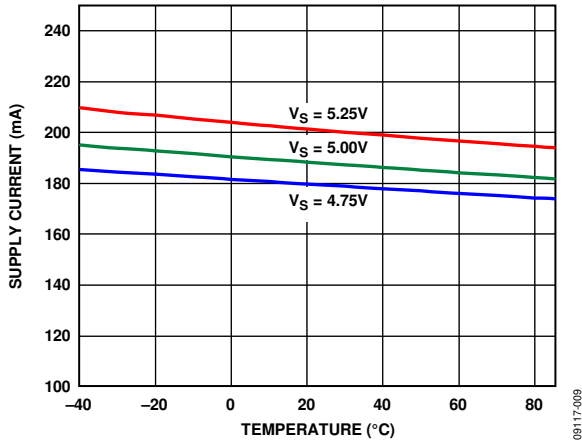

Figure 9. Supply Current vs. Temperature

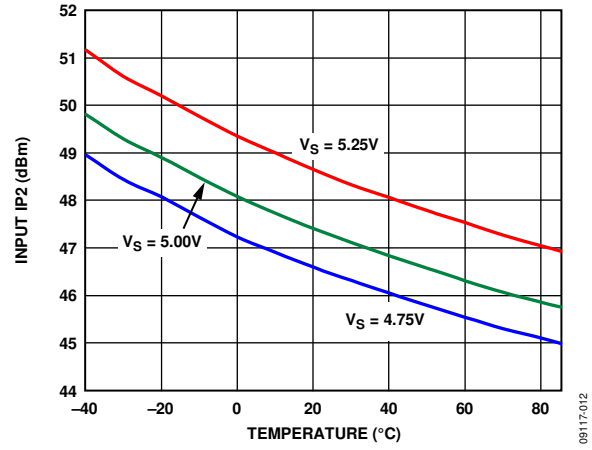

Figure 12. Input IP2 vs. Temperature

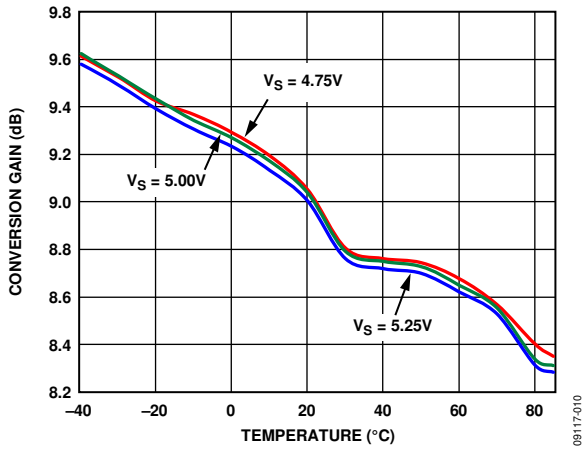

Figure 10. Power Conversion Gain vs. Temperature

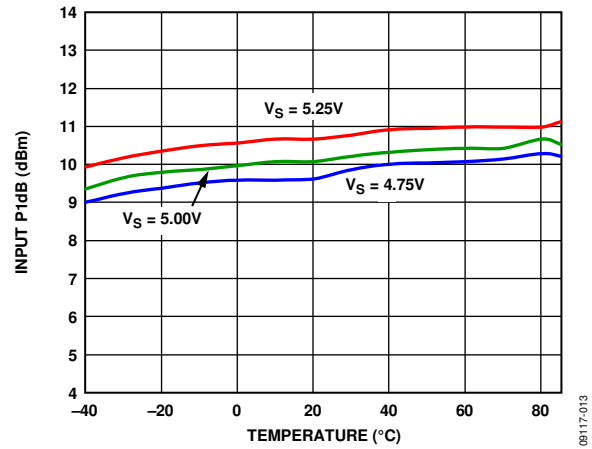

Figure 13. Input P1dB vs. Temperature

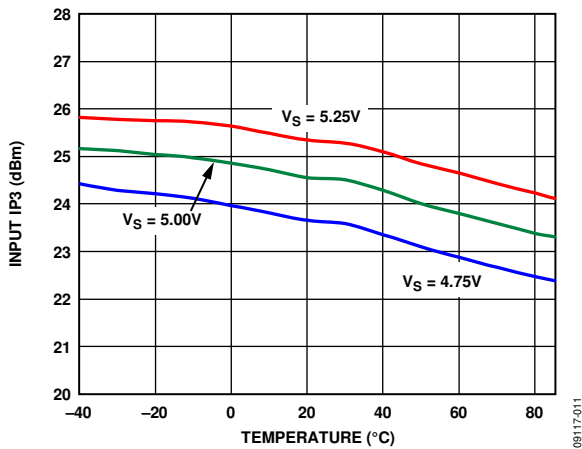

Figure 11. Input IP3 vs. Temperature

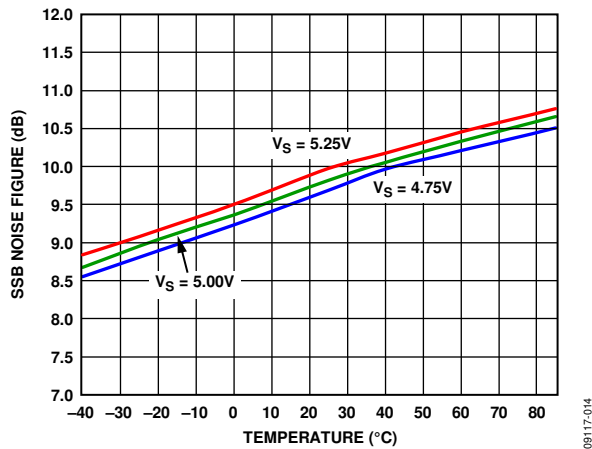

Figure 14. SSB Noise Figure vs. Temperature

$V_S = 5\text{ V}$ ,  $I_S = 190\text{ mA}$ ,  $T_A = 25^\circ\text{C}$ ,  $f_{RF} = 2535\text{ MHz}$ ,  $f_{LO} = 2738\text{ MHz}$ , LO power = 0 dBm,  $R_{14} = 910\ \Omega$ ,  $V_{GS0} = V_{GS1} = 0\text{ V}$ , and  $Z_O = 50\ \Omega$ , unless otherwise noted.

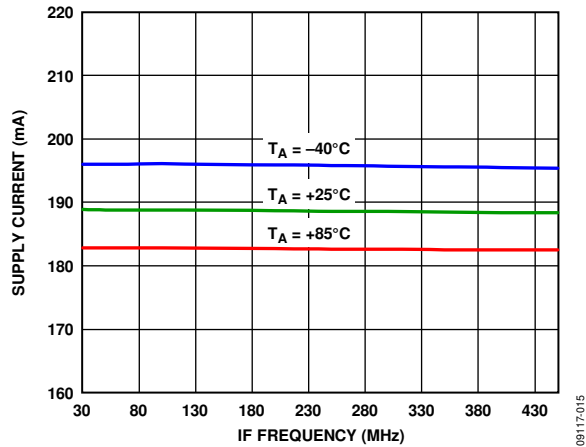

Figure 15. Supply Current vs. IF Frequency

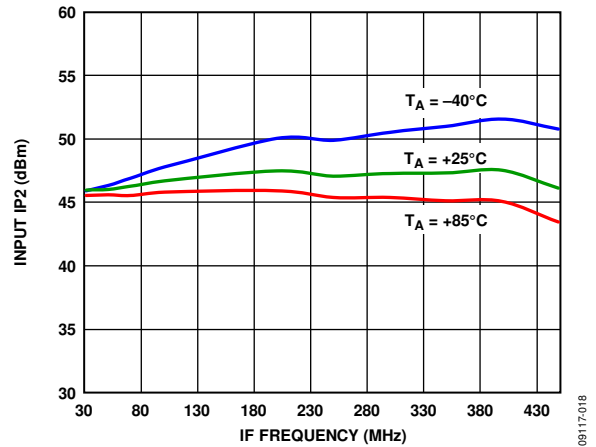

Figure 18. Input IP2 vs. IF Frequency

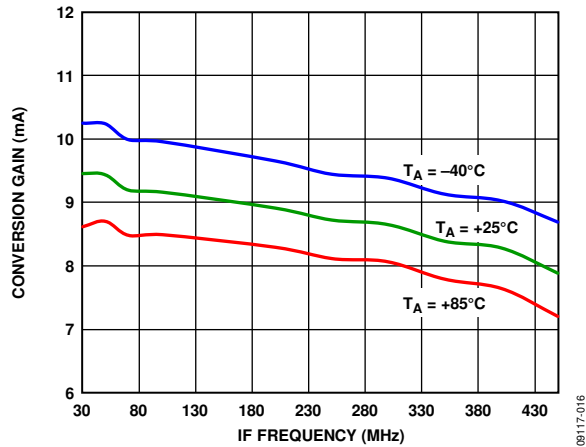

Figure 16. Power Conversion Gain vs. IF Frequency

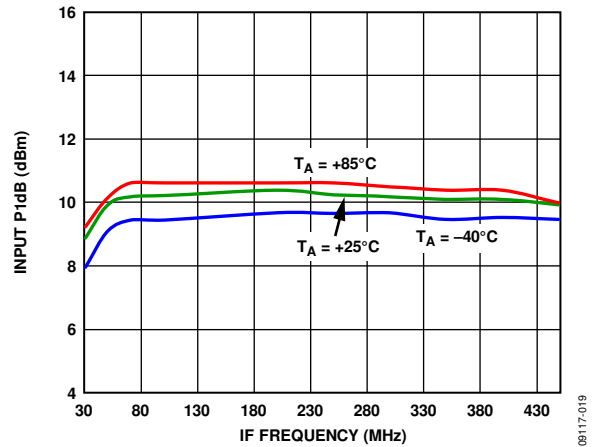

Figure 19. Input P1dB vs. IF Frequency

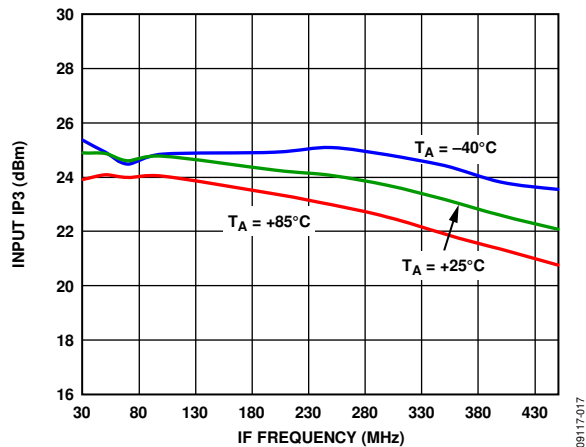

Figure 17. Input IP3 vs. IF Frequency

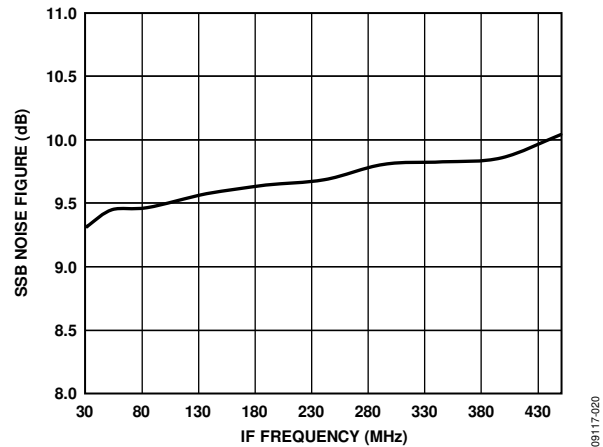

Figure 20. SSB Noise Figure vs. IF Frequency

$V_S = 5\text{ V}$ ,  $I_S = 190\text{ mA}$ ,  $T_A = 25^\circ\text{C}$ ,  $f_{RF} = 2535\text{ MHz}$ ,  $f_{LO} = 2738\text{ MHz}$ , LO power = 0 dBm,  $R_{14} = 910\ \Omega$ ,  $V_{GS0} = V_{GS1} = 0\text{ V}$ , and  $Z_O = 50\ \Omega$ , unless otherwise noted.

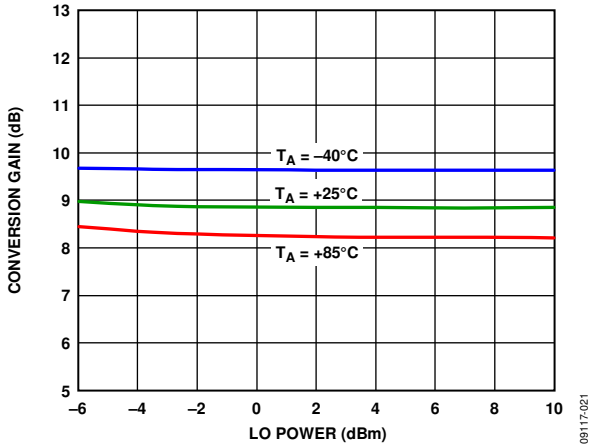

Figure 21. Power Conversion Gain vs. LO Power

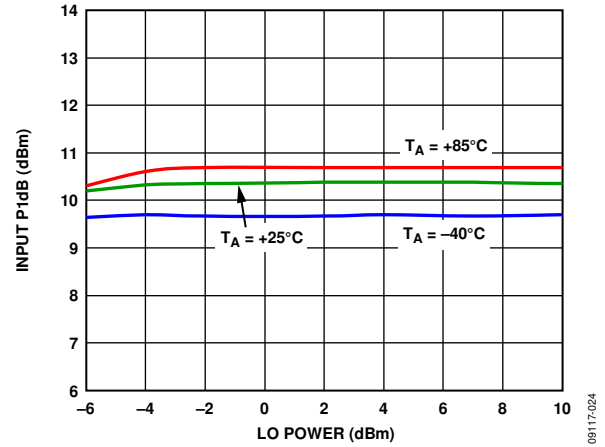

Figure 24. Input P1dB vs. LO Power

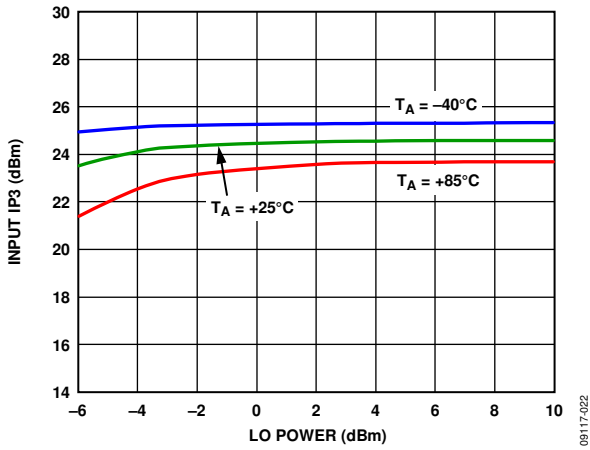

Figure 22. Input IP3 vs. LO Power

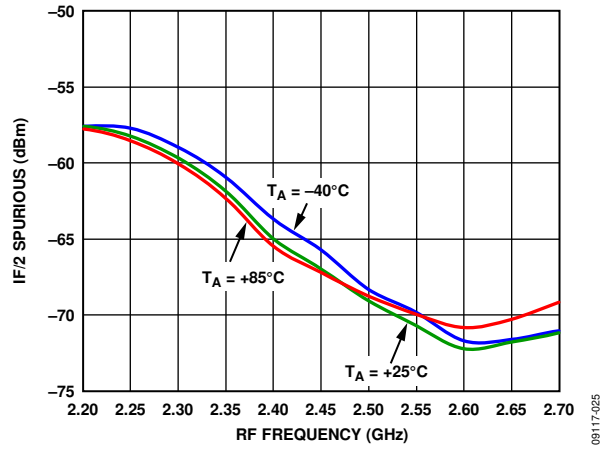

Figure 25. IF/2 Spurious vs. RF Frequency, RF Power = -10 dBm

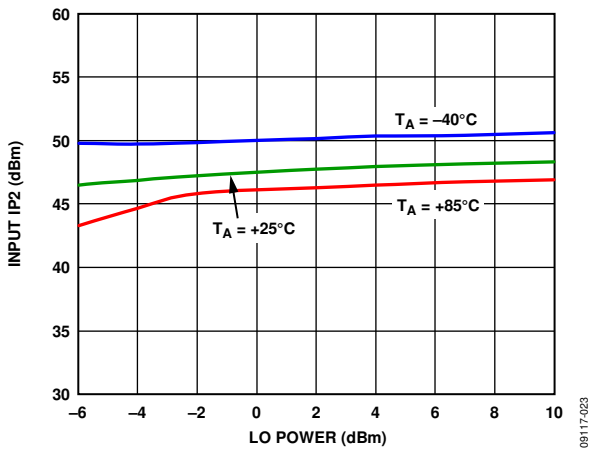

Figure 23. Input IP2 vs. LO Power

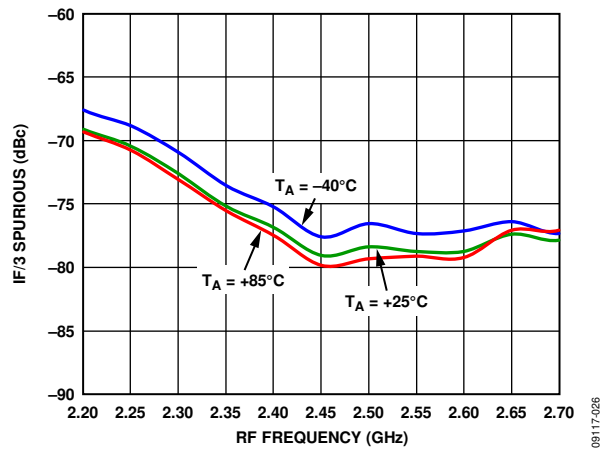

Figure 26. IF/3 Spurious vs. RF Frequency, RF Power = -10 dBm

$V_S = 5\text{ V}$ ,  $I_S = 190\text{ mA}$ ,  $T_A = 25^\circ\text{C}$ ,  $f_{RF} = 2535\text{ MHz}$ ,  $f_{LO} = 2738\text{ MHz}$ , LO power = 0 dBm,  $R_{14} = 910\ \Omega$ ,  $V_{GS0} = V_{GS1} = 0\text{ V}$ , and  $Z_O = 50\ \Omega$ , unless otherwise noted.

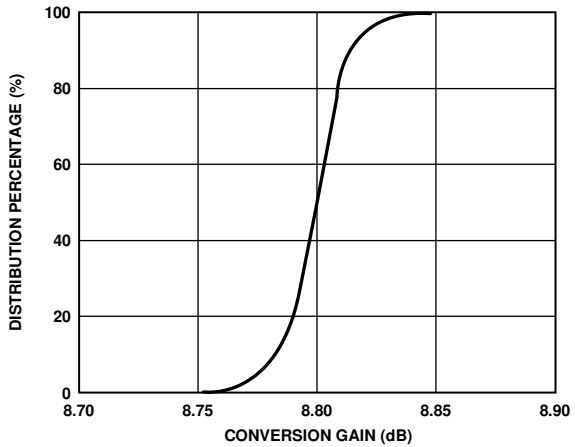

Figure 27. Power Conversion Gain Distribution

09117-027

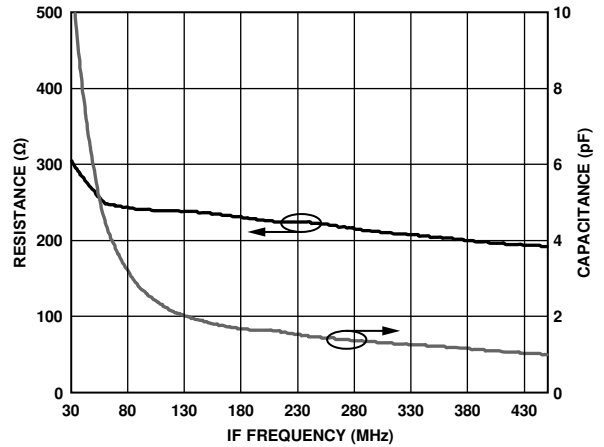

Figure 30. IF Differential Output Impedance (R Parallel C Equivalent)

09117-030

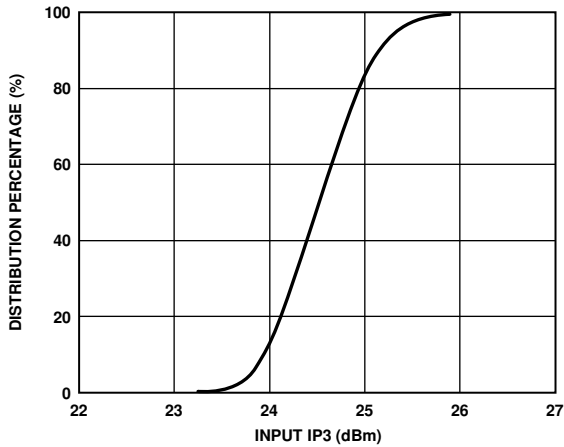

Figure 28. Input IP3 Distribution

09117-028

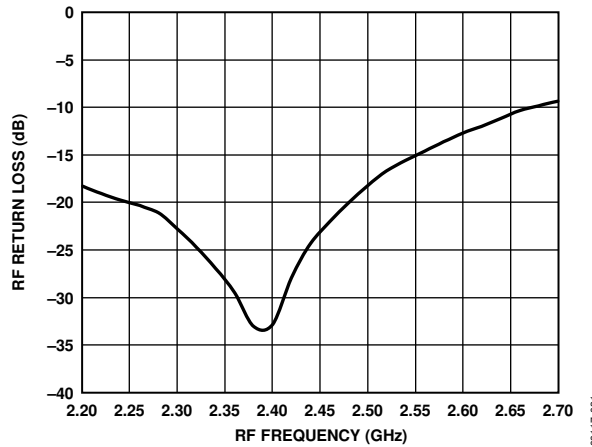

Figure 31. RF Port Return Loss, Fixed IF

09117-031

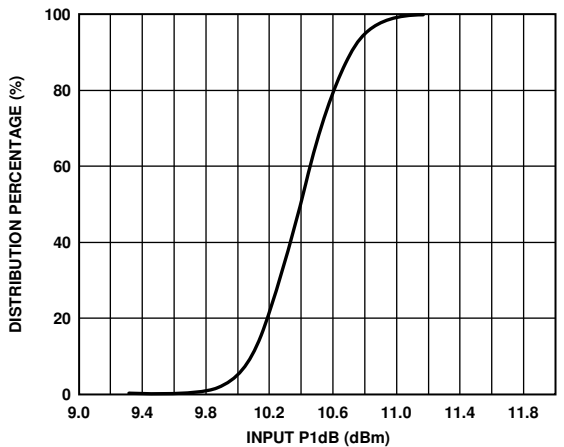

Figure 29. Input P1dB Distribution

09117-029

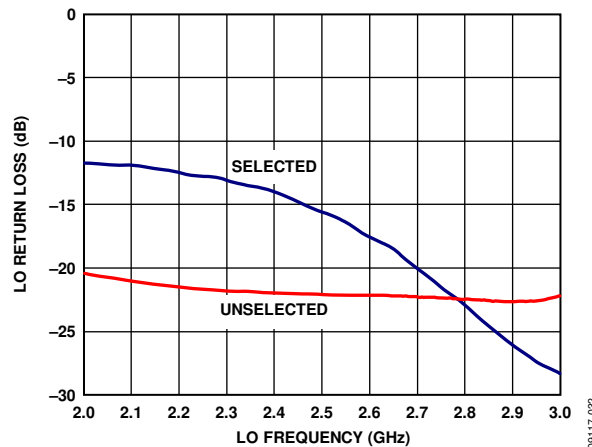

Figure 32. LO Return Loss, Selected and Unselected

09117-032

$V_S = 5\text{ V}$ ,  $I_S = 190\text{ mA}$ ,  $T_A = 25^\circ\text{C}$ ,  $f_{RF} = 2535\text{ MHz}$ ,  $f_{LO} = 2738\text{ MHz}$ , LO power = 0 dBm,  $R_{14} = 910\ \Omega$ ,  $V_{GS0} = V_{GS1} = 0\text{ V}$ , and  $Z_O = 50\ \Omega$ , unless otherwise noted.

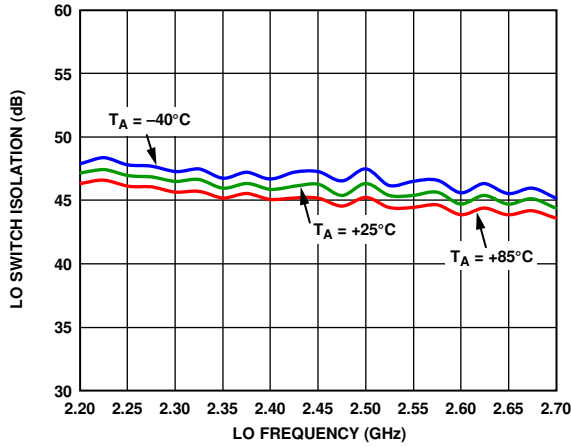

Figure 33. LO Switch Isolation vs. LO Frequency

09117-033

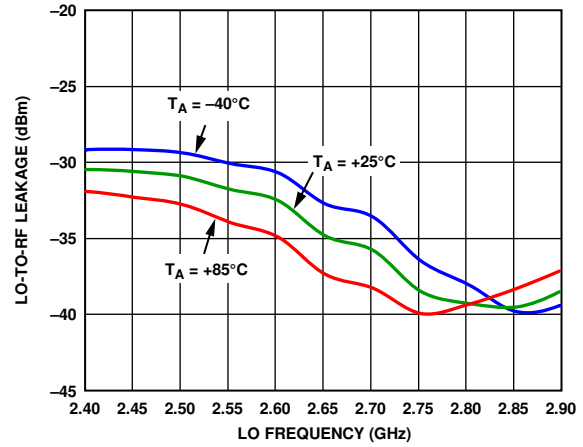

Figure 36. LO-to-RF Leakages vs. LO Frequency

09117-036

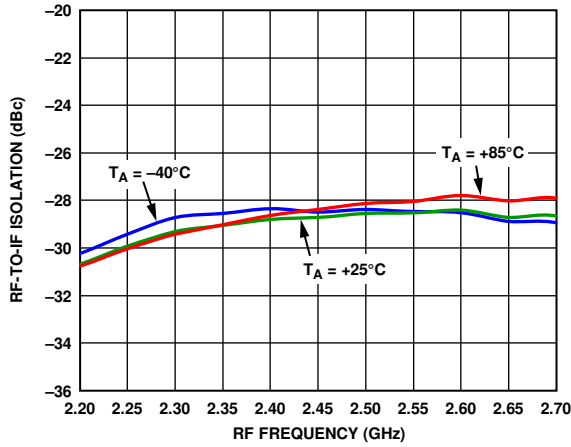

Figure 34. RF-to-IF Isolation vs. RF Frequency

09117-034

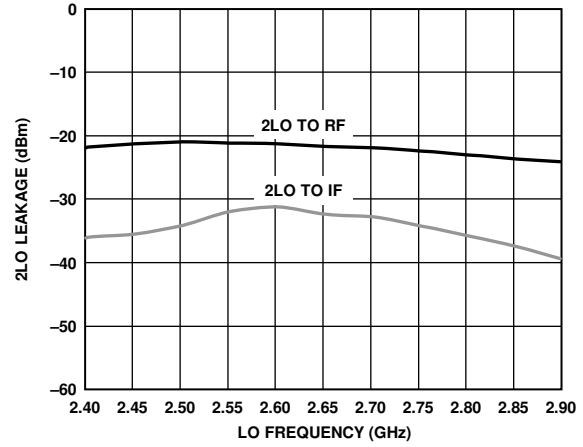

Figure 37. 2LO Leakage vs. LO Frequency

09117-037

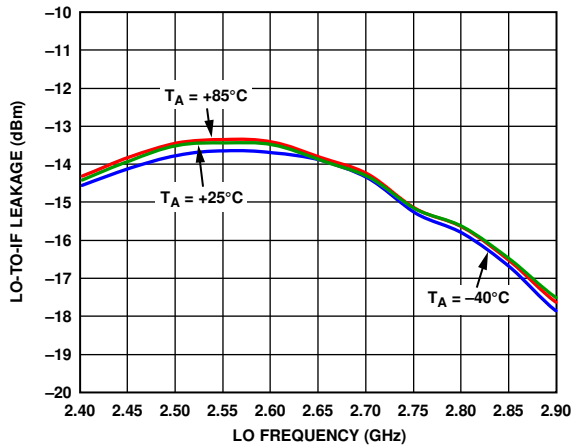

Figure 35. LO-to-IF Leakage vs. LO Frequency

09117-035

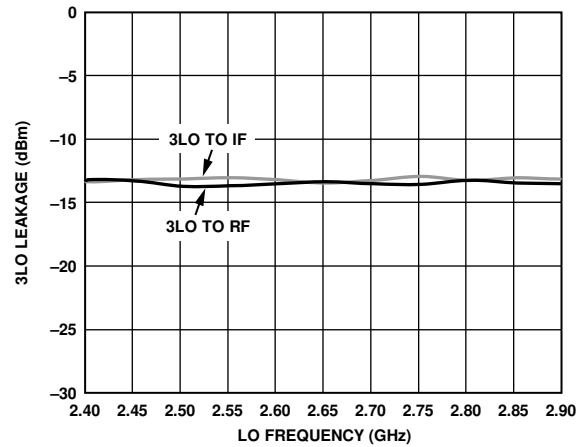

Figure 38. 3LO Leakage vs. LO Frequency

09117-038

$V_S = 5\text{ V}$ ,  $I_S = 190\text{ mA}$ ,  $T_A = 25^\circ\text{C}$ ,  $f_{RF} = 2535\text{ MHz}$ ,  $f_{LO} = 2738\text{ MHz}$ , LO power = 0 dBm,  $R_{14} = 910\ \Omega$ ,  $V_{GS0} = V_{GS1} = 0\text{ V}$ , and  $Z_O = 50\ \Omega$ , unless otherwise noted.

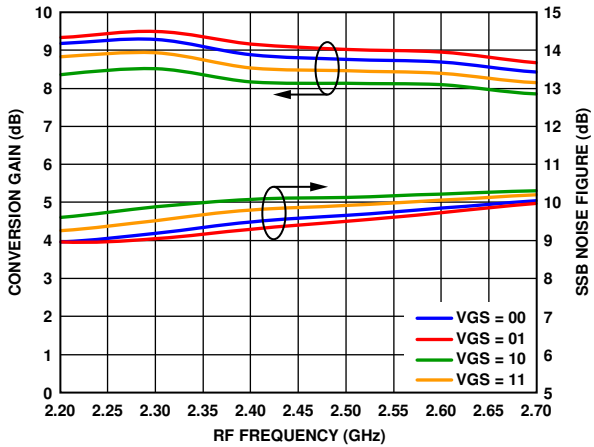

Figure 39. Power Conversion Gain and SSB Noise Figure vs. RF Frequency

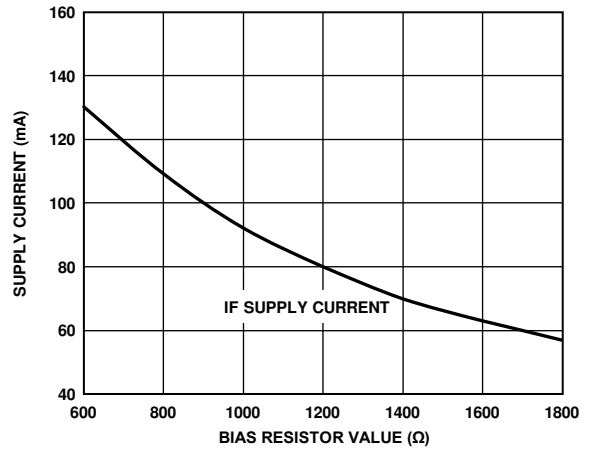

Figure 41. IF Supply Current vs. IF Bias Resistor Value

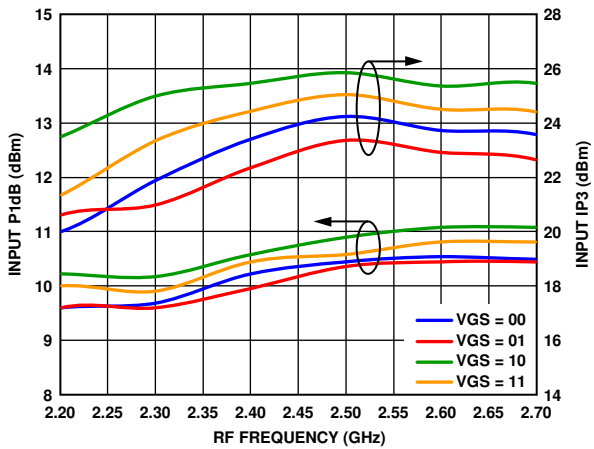

Figure 40. Input IP3 and Input P1dB vs. RF Frequency

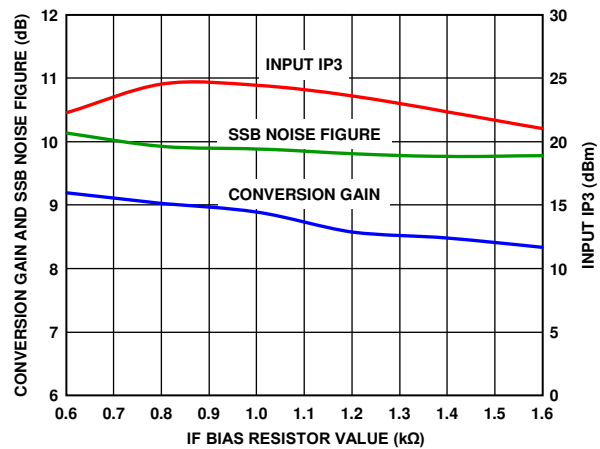

Figure 42. Power Conversion Gain, SSB Noise Figure, and Input IP3 vs. IF Bias Resistor Value

**3.3 V PERFORMANCE**

$V_S = 3.3\text{ V}$ ,  $I_S = 125\text{ mA}$ ,  $T_A = 25^\circ\text{C}$ ,  $f_{RF} = 2535\text{ MHz}$ ,  $f_{LO} = 2738\text{ MHz}$ , LO power = 0 dBm,  $R_9 = 226\ \Omega$ ,  $R_{14} = 604\ \Omega$ ,  $V_{GS0} = V_{GS1} = 0\text{ V}$ , and  $Z_O = 50\ \Omega$ , unless otherwise noted.

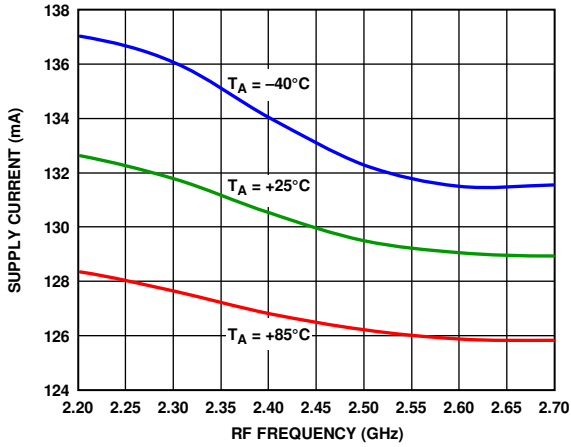

Figure 43. Supply Current vs. RF Frequency at 3.3 V

09117-045

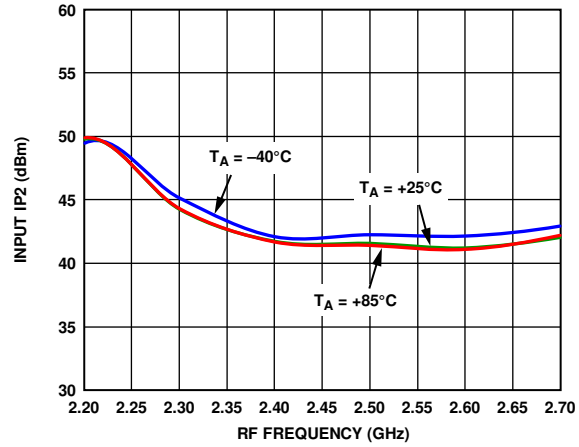

Figure 46. Input IP2 vs. RF Frequency at 3.3 V

09117-048

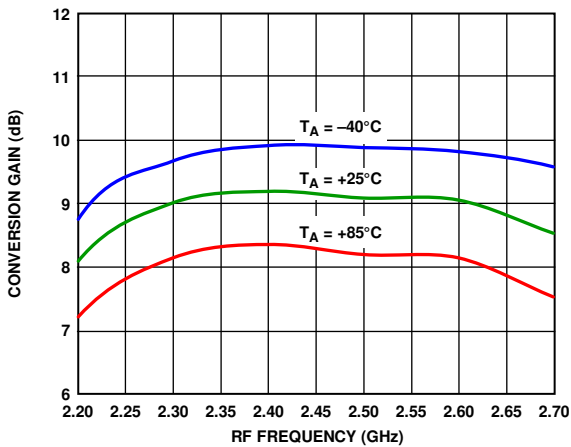

Figure 44. Power Conversion Gain vs. RF Frequency at 3.3 V

09117-046

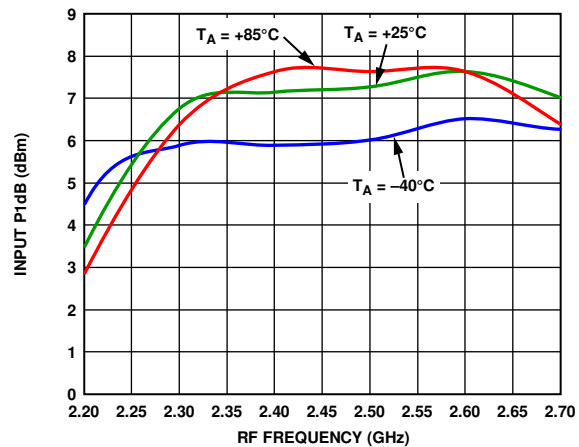

Figure 47. Input P1dB vs. RF Frequency at 3.3 V

09117-049

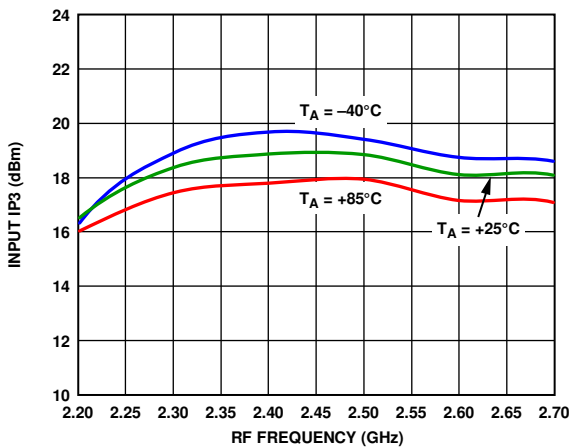

Figure 45. Input IP3 vs. RF Frequency at 3.3 V

09117-047

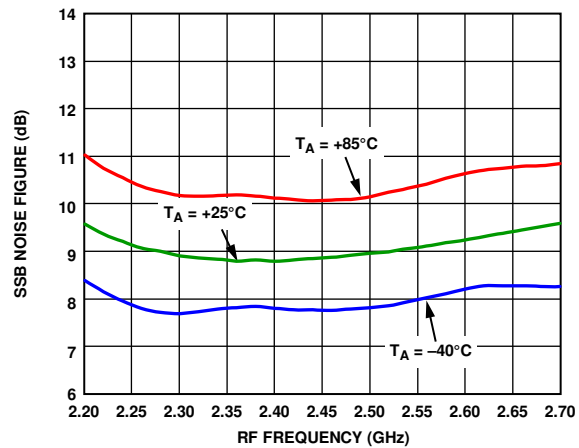

Figure 48. SSB Noise Figure vs. RF Frequency at 3.3 V

09117-050



# SPUR TABLES

## SPUR TABLES

All spur tables are  $(N \times f_{RF}) - (M \times f_{LO})$  and were measured using the standard evaluation board. Mixer spurious products are measured in dBc from the IF output power level. Data was measured for frequencies less than 6 GHz only. Typical noise floor of the measurement system = -100 dBm.

### 5 V Performance

$V_S = 5\text{ V}$ ,  $I_S = 190\text{ mA}$ ,  $T_A = 25^\circ\text{C}$ ,  $f_{RF} = 2600\text{ MHz}$ ,  $f_{LO} = 2803\text{ MHz}$ , LO power = 0 dBm, RF power = -10 dBm, VGS0 = VGS1 = VGS2 = 0 V, and  $Z_O = 50\ \Omega$ , unless otherwise noted.

		M														
		0	1	2	3	4	5	6	7	8	9	10	11	12	13	14
N	0		-14.9	-33.1												
	1	-36.5	0.00	-63.4	-59.8											
	2	-80.2	-87.8	-66.8	-86.8											
	3		<-100	<-100	-96.7	<-100										
	4			<-100	<-100	<-100	<-100									
	5				<-100	<-100	<-100	<-100								
	6					<-100	<-100	<-100	<-100							
	7						<-100	<-100	<-100	<-100						
	8							<-100	<-100	<-100	<-100					
	9								<-100	<-100	<-100	<-100				
	10									<-100	<-100	<-100	<-100			
	11										<-100	<-100	<-100	<-100		
	12											<-100	<-100	<-100	<-100	
	13												<-100	<-100	<-100	<-100
	14													<-100	<-100	<-100

### 3.3 V Performance

$V_S = 3.3\text{ V}$ ,  $I_S = 125\text{ mA}$ ,  $T_A = 25^\circ\text{C}$ ,  $f_{RF} = 2600\text{ MHz}$ ,  $f_{LO} = 2803\text{ MHz}$ , LO power = 0 dBm, RF power = -10 dBm, R9 = 226  $\Omega$ , R14 = 604  $\Omega$ , VGS0 = VGS1 = 0 V, and  $Z_O = 50\ \Omega$ , unless otherwise noted.

		M														
		0	1	2	3	4	5	6	7	8	9	10	11	12	13	14
N	0		-20.2	-45.0												
	1	-36.9	0.00	-57.7	-66.5											
	2	-81.7	-74.3	-63.7	-81.9											
	3		<-100	-97.9	-69.2	<-100										
	4			<-100	<-100	<-100	<-100									
	5				<-100	<-100	<-100	<-100								
	6					<-100	<-100	<-100	<-100							
	7						<-100	<-100	<-100	<-100	<-100					
	8							<-100	<-100	<-100	<-100	<-100				
	9								<-100	<-100	<-100	<-100	<-100			
	10									<-100	<-100	<-100	<-100	<-100		
	11										<-100	<-100	<-100	<-100		
	12											<-100	<-100	<-100	<-100	
	13												<-100	<-100	<-100	<-100
	14													<-100	<-100	<-100
	15														<-100	<-100

## CIRCUIT DESCRIPTION

The **ADL5353** consists of two primary components: the radio frequency (RF) subsystem and the local oscillator (LO) subsystem. The combination of design, process, and packaging technology allows the functions of these subsystems to be integrated into a single die, using mature packaging and interconnection technologies to provide a high performance, low cost design with excellent electrical, mechanical, and thermal properties. In addition, the need for external components is minimized, thereby optimizing cost and size.

The RF subsystem consists of an integrated, low loss RF balun, passive MOSFET mixer, sum termination network, and IF amplifier.

The LO subsystem consists of an SPDT-terminated FET switch and a three stage, limiting LO amplifier. The purpose of the LO subsystem is to provide a large, fixed amplitude, balanced signal to drive the mixer independent of the level of the LO input. A block diagram of the device is shown in Figure 49.

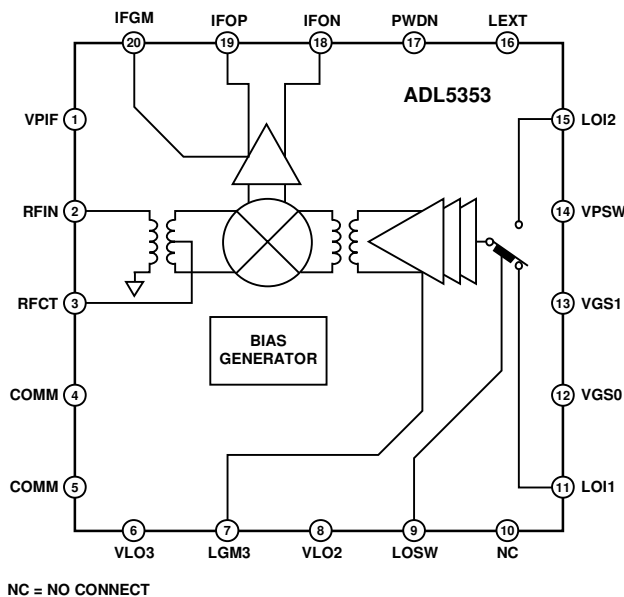

Figure 49. Simplified Schematic

### RF SUBSYSTEM

The single-ended, 50  $\Omega$  RF input is internally transformed to a balanced signal using a low loss (<1 dB) unbalanced-to-balanced (balun) transformer. This transformer is made possible by an extremely low loss metal stack, which provides both excellent balance and dc isolation for the RF port. Although the port can be dc connected, it is recommended that a blocking capacitor be used to avoid running excessive dc current through the part. The RF balun can easily support an RF input frequency range of 2200 MHz to 2700 MHz.

The resulting balanced RF signal is applied to a passive mixer that commutates the RF input with the output of the LO subsystem. The passive mixer is essentially a balanced, low loss switch that

adds minimum noise to the frequency translation. The only noise contribution from the mixer is due to the resistive loss of the switches, which is in the order of a few ohms.

Because the mixer is inherently broadband and bidirectional, it is necessary to properly terminate all the idler ( $M \times N$  product) frequencies generated by the mixing process. Terminating the mixer avoids the generation of unwanted intermodulation products and reduces the level of unwanted signals at the input of the IF amplifier, where high peak signal levels can compromise the compression and intermodulation performance of the system. This termination is accomplished by the addition of a sum network between the IF amplifier and the mixer and also in the feedback elements in the IF amplifier.

The IF amplifier is a balanced feedback design that simultaneously provides the desired gain, noise figure, and input impedance that are required to achieve the overall performance. The balanced open-collector output of the IF amplifier, with impedance modified by the feedback within the amplifier, permits the output to be connected directly to a high impedance filter, differential amplifier, or to an analog-to-digital input while providing optimum second-order intermodulation suppression. The differential output impedance of the IF amplifier is approximately 200  $\Omega$ . If operation in a 50  $\Omega$  system is desired, the output can be transformed to 50  $\Omega$  by using a 4:1 transformer.

The intermodulation performance of the design is generally limited by the IF amplifier. The Input IP3 performance can be optimized by adjusting the IF current with an external resistor. Figure 41 and Figure 42 illustrate how various IF and LO bias resistors affect the performance with a 5 V supply. Additionally, dc current can be saved by increasing either or both resistors. It is permissible to reduce the dc supply voltage to as low as 3.3 V, further reducing the dissipated power of the part. (Note that no performance enhancement is obtained by reducing the value of these resistors, and excessive dc power dissipation may result.)

### LO SUBSYSTEM

The **ADL5353** has two LO inputs permitting multiple synthesizers to be rapidly switched with extremely short switching times (<40 ns) for frequency agile applications. The two inputs are applied to a high isolation SPDT switch that provides a constant input impedance, regardless of whether the port is selected, to avoid pulling the LO sources. This multiple section switch also ensures high isolation to the off input, minimizing any leakage from the unwanted LO input that may result in undesired IF responses.

The single-ended LO input is converted to a fixed amplitude differential signal using a multistage, limiting LO amplifier. This results in consistent performance over a range of LO input power. Optimum performance is achieved from -6 dBm to +10 dBm, but the circuit continues to function at considerably lower levels of LO input power.

The performance of this amplifier is critical in achieving a high intercept passive mixer without degrading the noise floor of the system. This is a critical requirement in an interferer rich environment, such as cellular infrastructure, where blocking interferers can limit mixer performance. The bandwidth of the intermodulation performance is somewhat influenced by the current in the LO amplifier chain. For dc current sensitive applications, it is permissible to reduce the current in the LO amplifier by raising the value of the external bias control resistor. For dc current critical applications, the LO chain can operate with a supply voltage as low as 3.3 V, resulting in substantial dc power savings.

In addition, when operating with supply voltages below 3.6 V, the [ADL5353](#) has a power-down mode that permits the dc current to drop to  $<200 \mu\text{A}$ .

All of the logic inputs are designed to work with any logic family that provides a Logic 0 input level of less than 0.4 V and a Logic 1 input level that exceeds 1.4 V. All logic inputs are high impedance up to Logic 1 levels of 3.3 V. At levels exceeding 3.3 V, protection circuitry permits operation of up to 5.5 V, although a small bias current is drawn.

All pins, including the RF pins, are ESD protected and have been tested to a level of 1500 V HBM and 500 V CDM.

## APPLICATIONS INFORMATION

### BASIC CONNECTIONS

The ADL5353 mixer is designed to downconvert radio frequencies (RF) primarily between 2200 MHz and 2700 MHz to lower intermediate frequencies (IF) between 30 MHz and 450 MHz. Figure 50 depicts the basic connections of the mixer. To prevent nonzero dc voltages from damaging the RF balun or LO input circuit, ac couple the RF and LO input ports. The RFIN matching network consists of a series 1.5 pF capacitor and a shunt 10 nH inductor to provide the optimized RF input return loss for the desired frequency band IF Port.

The mixer differential IF interface requires pull-up choke inductors to bias the open-collector outputs and to set the output match. The shunting impedance of the choke inductors used to couple dc current into the IF amplifier should be selected to provide the desired output return loss.

The real part of the output impedance is approximately 200  $\Omega$ , which matches many commonly used SAW filters without the

need for a transformer. This results in a voltage conversion gain that is approximately 6 dB higher than the power conversion gain, as shown in Table 3. When a 50  $\Omega$  output impedance is needed, use a 4:1 impedance transformer, as shown in Figure 50.

### BIAS RESISTOR SELECTION

Two external resistors,  $R_{BIAS\ IF}$  and  $R_{BIAS\ LO}$ , are used to adjust the bias current of the integrated amplifiers at the IF and LO terminals. It is necessary to have a sufficient amount of current to bias both the internal IF and LO amplifiers to optimize dc current vs. optimum IIP3 performance.

### MIXER VGS CONTROL DAC

The ADL5353 features two logic control pins, VGS0 (Pin 12) and VGS1 (Pin 13), that allow programmability for internal gate-to-source voltages for optimizing mixer performance over desired frequency bands. The evaluation board defaults both VGS0 and VGS1 to ground.

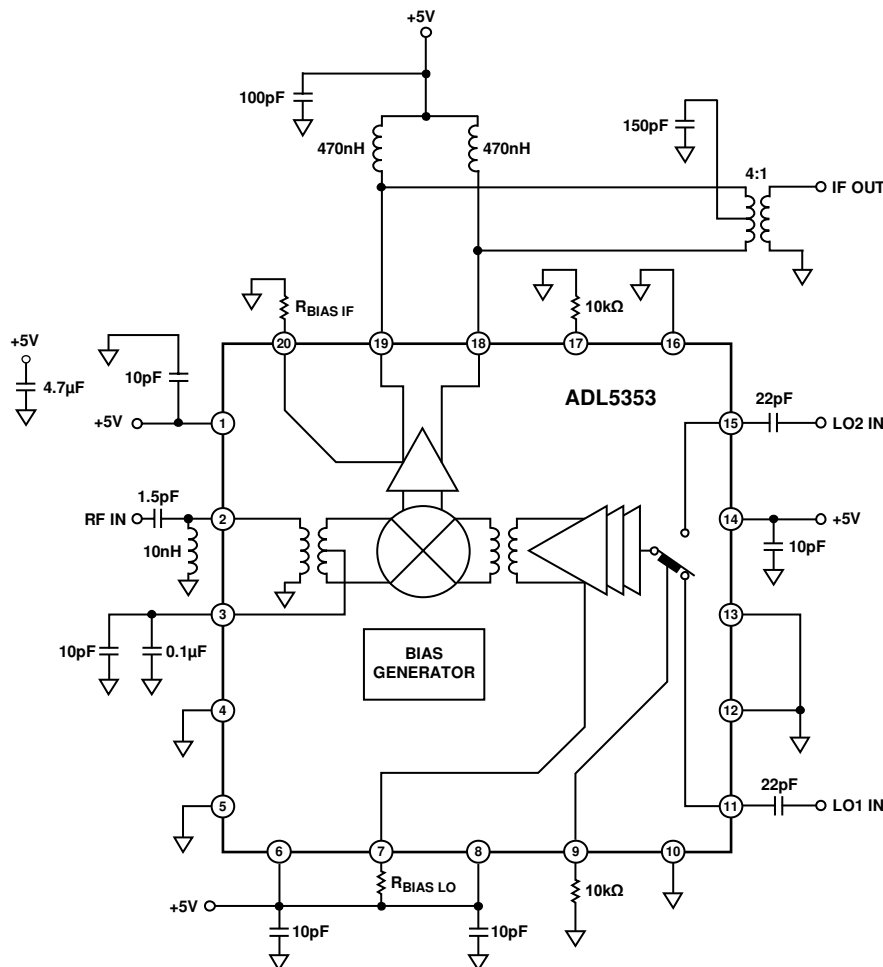

Figure 50. Typical Application Circuit

09117-150

### EVALUATION BOARD

An evaluation board is available for the family of double balanced mixers. The standard evaluation board schematic is shown in Figure 51. The evaluation board is fabricated using Rogers® RO3003 material.

Table 7 describes the various configuration options of the evaluation board. Evaluation board layout is shown in Figure 52 to Figure 55.

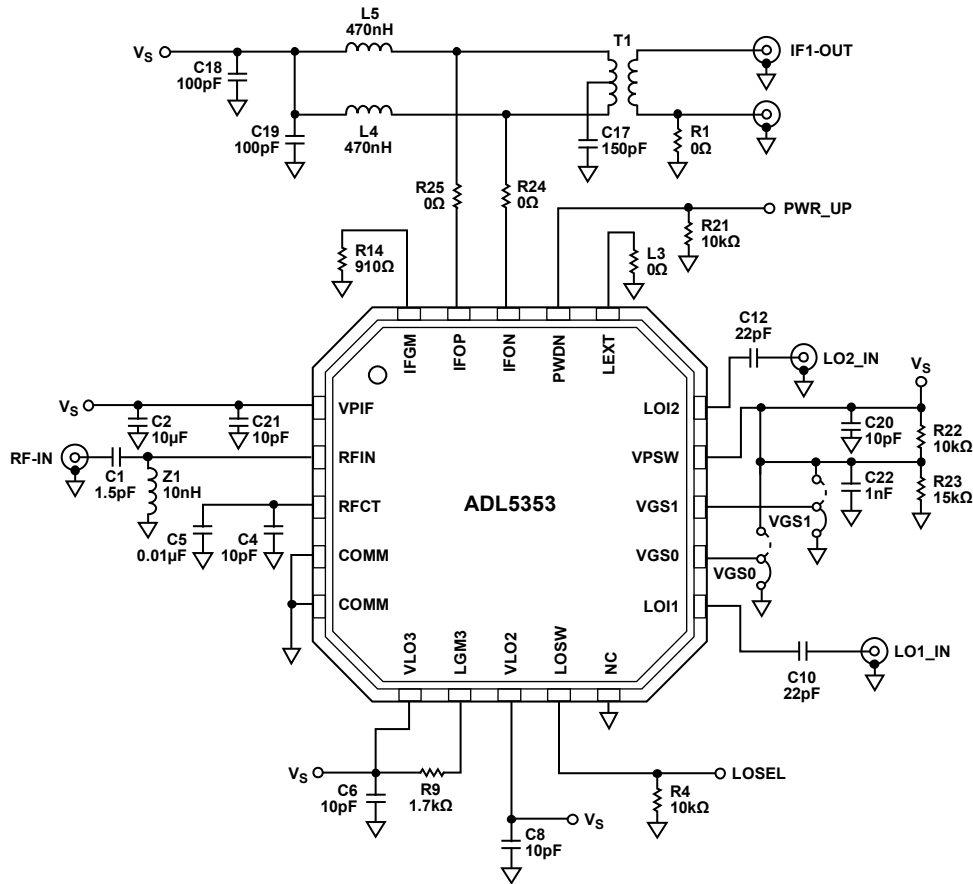

Figure 51. Evaluation Board Schematic

08117-151

Table 7. Evaluation Board Configuration

Components	Function	Description	Default Conditions
C2, C6, C8, C18, C19, C20, C21	Power supply decoupling	Nominal supply decoupling consists of a 10 $\mu$ F capacitor to ground in parallel with a 10 pF capacitor to ground positioned as close to the device as possible.	C2 = 10 $\mu$ F (size 0603) C6, C8, C20, C21 = 10 pF (size 0402) C18, C19 = 100 pF (size 0402)
C1, C4, C5, Z1	RF input interface	The input channels are ac-coupled through C1. C4 and C5 provide bypassing for the center taps of the RF input baluns.	C1 = 1.5 pF (size 0402) C4 = 10 pF (size 0402) C5 = 0.01 $\mu$ F (size 0402) Z1 = 10 nH (size 0402)
T1, C17, L4, L5, R1, R24, R25	IF output interface	The open-collector IF output interfaces are biased through pull-up choke inductors, L4 and L5. T1 is a 4:1 impedance transformer used to provide a single-ended IF output interface, with C17 providing center-tap bypassing. Remove R1 for balanced output operation.	T1 = TC4-1W+ (Mini-Circuits ) C17 = 150 pF (size 0402) L4, L5 = 470 nH (size 1008) R1, R24, R25 = 0 $\Omega$ (size 0402)
C10, C12, R4	LO interface	C10 and C12 provide ac coupling for the LO1_IN and LO2_IN local oscillator inputs. LOSEL selects the appropriate LO input for both mixer cores. R4 provides a pull-down to ensure that LO1_IN is enabled when the LOSEL test point is logic low. LO2_IN is enabled when LOSEL is pulled to logic high.	C10, C12 = 22 pF (size 0402) R4 = 10 k $\Omega$ (size 0402)
R21	PWDN interface	R21 pulls the PWDN logic low and enables the device. The PWR_UP test point allows the PWDN interface to be exercised using the external logic generator. Grounding the PWDN pin for nominal operation is allowed. Using the PWDN pin when supply voltages exceed 3.3 V is not allowed.	R21 = 10 k $\Omega$ (size 0402)
C22, L3, R9, R14, R22, R23, VGS0, VGS1	Bias control	R22 and R23 form a voltage divider to provide 3 V for logic control, bypassed to ground through C22. VGS0 and VGS1 jumpers provide programmability at the VGS0 and VGS1 pins. It is recommended to pull these two pins to ground for nominal operation. R9 sets the bias point for the internal LO buffers. R14 sets the bias point for the internal IF amplifier.	C22 = 1 nF (size 0402) L3 = 0 $\Omega$ (size 0603) R9 = 1.7 k $\Omega$ (size 0402) R14 = 910 $\Omega$ (size 0402) R22 = 10 k $\Omega$ (size 0402) R23 = 15 k $\Omega$ (size 0402) VGS0 = VGS1 = 3-pin shunt



OUTLINE DIMENSIONS

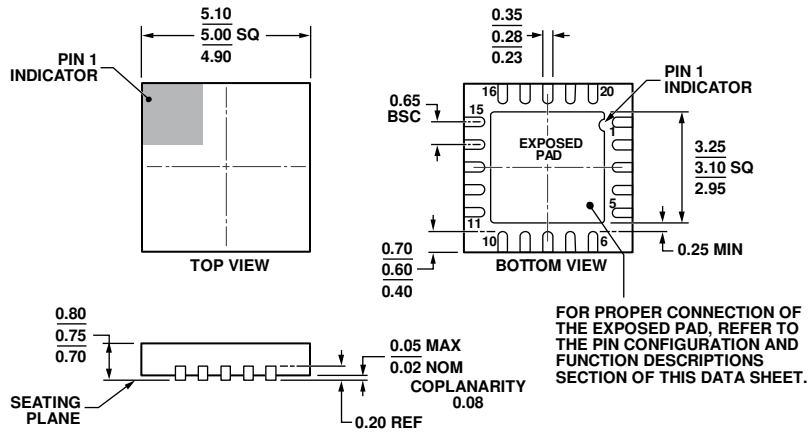

COMPLIANT TO JEDEC STANDARDS MO-220-WHHC.  
 Figure 56. 20-Lead Lead Frame Chip Scale Package [LFCS<sub>P</sub>\_WQ]  
 5 mm × 5 mm Body, Very Very Thin Quad  
 (CP-20-9)  
 Dimensions shown in millimeters

111909A

ORDERING GUIDE

Model <sup>1</sup>	Temperature Range	Package Description	Package Option	Ordering Quantity
ADL5353ACPZ-R7	-40°C to +85°C	20-Lead Lead Frame Chip Scale Package [LFCS <sub>P</sub> _WQ]	CP-20-9	1,500 7" Tape and Reel
ADL5353-EVALZ		Evaluation Board		1

<sup>1</sup> Z = RoHS Compliant Part.



**NOTES**

**NOTES**