



Chipsmall Limited consists of a professional team with an average of over 10 year of expertise in the distribution of electronic components. Based in Hongkong, we have already established firm and mutual-benefit business relationships with customers from,Europe,America and south Asia,supplying obsolete and hard-to-find components to meet their specific needs.

With the principle of "Quality Parts,Customers Priority,Honest Operation,and Considerate Service",our business mainly focus on the distribution of electronic components. Line cards we deal with include Microchip,ALPS,ROHM,Xilinx,Pulse,ON,Everlight and Freescale. Main products comprise IC,Modules,Potentiometer,IC Socket,Relay,Connector.Our parts cover such applications as commercial,industrial, and automotives areas.

We are looking forward to setting up business relationship with you and hope to provide you with the best service and solution. Let us make a better world for our industry!



## Contact us

Tel: +86-755-8981 8866 Fax: +86-755-8427 6832

Email & Skype: info@chipsmall.com Web: www.chipsmall.com

Address: A1208, Overseas Decoration Building, #122 Zhenhua RD., Futian, Shenzhen, China



## FEATURES

### Serial CPRI data rates

614.4 Mbps, 1.2288 Gbps, 2.4576 Gbps, 3.072 Gbps,  
4.9152 Gbps, 6.144 Gbps, and 9.8304 Gbps

### Ethernet data rates: 1.25 Gbps and 10.3125 Gbps

### No reference clock required

### Jitter performance superior to the SFF-8431 jitter specifications

### Optional equalizer or 0 dB EQ input mode

### Quantizer sensitivity: 200 mV p-p typical (equalizer mode)

### Sample phase adjust (5.65 Gbps or greater)

### Output polarity invert

### I<sup>2</sup>C to access optional features

### Loss of lock (LOL) indicator

### PRBS generator/detector

### Application aware power

349.5 mW at 9.8304 Gbps, 0 dB EQ input mode  
287.7 mW at 6.144 Gbps, 0 dB EQ input mode  
249.3 mW at 3.072 Gbps, 0 dB EQ input mode

### Power supply: 1.2 V, flexible 1.8 V to 3.3 V, and 3.3 V

### 4 mm × 4 mm, 24-lead LFCSP

## APPLICATIONS

### SFF-8431-compatible

### Ethernet: 10GE, 1GE, and CPRI: OS/L.6 up to OS/L.96

## GENERAL DESCRIPTION

The ADN2905 provides the receiver functions of quantization and multirate data recovery at 614.4 Mbps, 1.2288 Gbps, 1.25 Gbps, 2.4576 Gbps, 3.072 Gbps, 4.9152 Gbps, 6.144 Gbps, 9.8304 Gbps, and 10.3125 Gbps, used in Common Public Radio Interface (CPRI) and gigabit Ethernet applications. The ADN2905 automatically locks to all the specified CPRI and Ethernet data rates without the need for an external reference clock or programming. The ADN2905 jitter performance exceeds the jitter requirement specified by SFF-8431.

The ADN2905 provides manual sample phase adjustment. Additionally, the user can select an equalizer or a 0 dB EQ as the input. The equalizer is either adaptive or can be manually set.

The ADN2905 also supports pseudorandom binary sequence (PRBS) generation, bit error detection, and input data rate readback features.

The ADN2905 is available in a compact 4 mm × 4 mm, 24-lead chip scale package (LFCSP). All ADN2905 specifications are defined over the ambient temperature range of -40°C to +85°C, unless otherwise noted.

## FUNCTIONAL BLOCK DIAGRAM

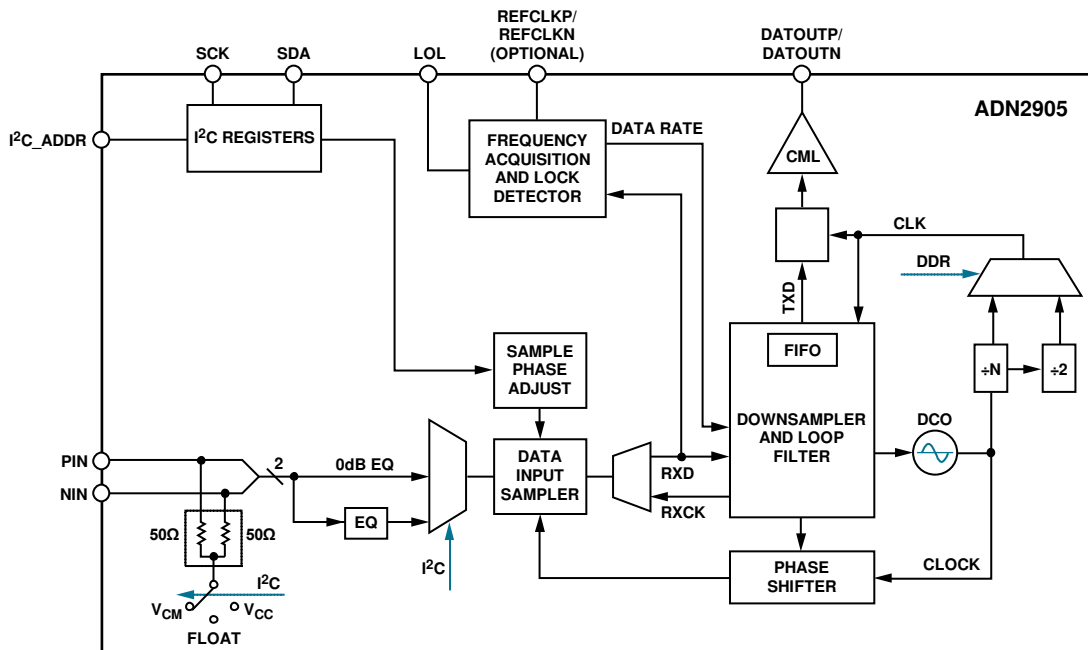

Figure 1.

Rev. A

### Document Feedback

Information furnished by Analog Devices is believed to be accurate and reliable. However, no responsibility is assumed by Analog Devices for its use, nor for any infringements of patents or other rights of third parties that may result from its use. Specifications subject to change without notice. No license is granted by implication or otherwise under any patent or patent rights of Analog Devices. Trademarks and registered trademarks are the property of their respective owners.

# ADN2905\* PRODUCT PAGE QUICK LINKS

Last Content Update: 02/23/2017

---

## COMPARABLE PARTS

View a parametric search of comparable parts.

## EVALUATION KITS

- ADN2905/ADN2913/ADN2915/ADN2917 Evaluation Board

## DOCUMENTATION

### Data Sheet

- ADN2905: CPRI and 10G Ethernet Data Recovery IC with Amp/EQ from 614.4 Mbps to 10.3125 Gbps Data Sheet

### User Guides

- UG-877: ADN2905/ADN2913/ADN2915/ADN2917 Evaluation Board Setup and Applications

## DESIGN RESOURCES

- ADN2905 Material Declaration
- PCN-PDN Information
- Quality And Reliability
- Symbols and Footprints

## DISCUSSIONS

View all ADN2905 EngineerZone Discussions.

## SAMPLE AND BUY

Visit the product page to see pricing options.

## TECHNICAL SUPPORT

Submit a technical question or find your regional support number.

## DOCUMENT FEEDBACK

Submit feedback for this data sheet.

---

## TABLE OF CONTENTS

|  |    |  |    |
|--|----|--|----|
| Features .....   | 1  | Theory of Operation .....  | 15 |
| Applications .....   | 1  | Functional Description .....   | 17 |
| General Description .....  | 1  | Frequency Acquisition .....  | 17 |
| Functional Block Diagram .....   | 1  | Edge Select .....  | 17 |
| Revision History .....   | 2  | Passive Equalizer .....  | 18 |
| Specifications .....   | 3  | 0 dB EQ .....  | 18 |
| Jitter Specifications .....  | 4  | Lock Detector Operation .....  | 18 |
| Output and Timing Specifications .....                                     | 5  | Harmonic Detector .....  | 19 |
| Timing Diagrams .....  | 6  | Output Disable and Squelch .....                                       | 19 |
| Absolute Maximum Ratings .....   | 7  | I <sup>2</sup> C Interface .....                                       | 20 |
| Thermal Characteristics .....  | 7  | Reference Clock (Optional) .....                                       | 20 |
| ESD Caution .....  | 7  | Additional Features Available via the I <sup>2</sup> C Interface ..... | 22 |
| Pin Configuration and Function Descriptions .....                          | 8  | Input Configurations .....   | 24 |
| Typical Performance Characteristics .....                                  | 9  | DC-Coupled Application .....   | 26 |
| I <sup>2</sup> C Interface Timing and Internal Register Descriptions ..... | 10 | Outline Dimensions .....   | 27 |
| Register Map .....   | 11 | Ordering Guide .....   | 27 |

## REVISION HISTORY

### 1/16—Rev 0. to Rev. A

|                                  |    |
|----------------------------------|----|
| Changes to Figure 5 .....        | 8  |
| Updated Outline Dimensions ..... | 27 |
| Changes to Ordering Guide .....  | 27 |

### 12/14—Revision 0: Initial Version

## SPECIFICATIONS

$T_A = T_{MIN}$  to  $T_{MAX}$ ,  $VCC = VCC_{MIN}$  to  $VCC_{MAX}$ ,  $VCC1 = VCC1_{MIN}$  to  $VCC1_{MAX}$ ,  $VDD = VDD_{MIN}$  to  $VDD_{MAX}$ ,  $VEE = 0$  V, input data pattern = PRBS  $2^{23} - 1$ , ac-coupled (to 100  $\Omega$  differential termination load), I<sup>2</sup>C register default settings, unless otherwise noted.

Table 1.

| Parameter  | Test Conditions/Comments   | Min    | Typ       | Max        | Unit     |
|--|--|--------|-----------|------------|----------|
| MULTIRATE SUPPORT RANGE  |  | 0.6144 |           | 10.3125    | Gbps     |
| INPUT—DC CHARACTERISTICS   |  |        |           |            |          |
| Peak-to-Peak Differential Input                                    | PIN – NIN, see Figure 29   |        |           | 1.0        | V        |
| Input Resistance   | Differential   | 95     | 100       | 105        | $\Omega$ |
| 0 dB EQ INPUT—CML COMPLIANT  |  |        |           |            |          |
| Input Voltage Range  | At PIN or NIN, dc-coupled, RX_TERM_FLOAT = 1 (floated)   | 0.5    |           | VCC        | V        |
| Input Common-Mode Level  | DC-coupled (see Figure 28), 600 mV p-p differential, RX_TERM_FLOAT = 1 (floated)                       | 0.65   |           | VCC – 0.15 | V        |
| Differential Input Sensitivity<br>CPRI $\times$ 16, 9.8304 Gbps    | AC-coupled, RX_TERM_FLOAT = 0 ( $V_{CM} = 1.2$ V), bit error rate (BER) = $1 \times 10^{-12}$          |        | 250       |            | mV p-p   |
| EQUALIZER INPUT PATH   |  |        |           |            |          |
| Differential Input Sensitivity<br>CPRI $\times$ 16, 9.8304 Gbps    | 15 inch FR-4, 100 $\Omega$ differential transmission line, adaptive EQ on<br>BER = $1 \times 10^{-12}$ |        | 200       |            | mV p-p   |
| INPUT—AC CHARACTERISTICS   |  |        |           |            |          |
| S11  | At 7.5 GHz, differential return loss, see Figure 8   |        | –12       |            | dB       |
| LOSS OF LOCK (LOL) DETECT  |  |        |           |            |          |
| Digital Control Oscillator (DCO)<br>Frequency Error for LOL Assert | With respect to nominal, data collected in lock to reference (LTR) mode                                |        | 1000      |            | ppm      |
| DCO Frequency Error for LOL Deassert                               | With respect to nominal, data collected in LTR mode  |        | 250       |            | ppm      |
| LOL Assert Response Time   | 2.4576 Gbps  |        | 51        |            | $\mu$ s  |
|  | 9.8304 Gbps  |        | 18        |            | $\mu$ s  |
| ACQUISITION TIME   |  |        |           |            |          |
| Lock to Data (LTD) Mode  | 2.4576 Gbps  |        | 0.5       |            | ms       |
|  | 9.8304 Gbps  |        | 0.5       |            | ms       |
| Optional LTR Mode <sup>1</sup>                                     |  |        | 6.0       |            | ms       |
| DATA RATE READBACK ACCURACY  |  |        |           |            |          |
| Coarse Readback  |  |        | $\pm 5$   |            | %        |
| Fine Readback  | In addition to reference clock accuracy  |        | $\pm 100$ |            | ppm      |
| POWER SUPPLY VOLTAGE   |  |        |           |            |          |
| VCC  |  | 1.14   | 1.2       | 1.26       | V        |
| VDD  |  | 2.97   | 3.3       | 3.63       | V        |
| VCC1   |  | 1.62   | 1.8       | 3.63       | V        |
| POWER SUPPLY CURRENT   |  |        |           |            |          |
| VCC  | 0 dB EQ input mode, clock output disabled  |        |           |            |          |
|  | 2.4576 Gbps  |        | 182.0     |            | mA       |
|  | 3.072 Gbps   |        | 159.1     |            | mA       |
|  | 4.9152 Gbps  |        | 180.8     |            | mA       |
|  | 6.144 Gbps   |        | 190.5     |            | mA       |
|  | 9.8304 Gbps  |        | 217.3     |            | mA       |
| VDD  | 2.4576 Gbps  |        | 8.6       |            | mA       |
|  | 3.072 Gbps   |        | 9.0       |            | mA       |
|  | 4.9152 Gbps  |        | 8.8       |            | mA       |
|  | 6.144 Gbps   |        | 8.9       |            | mA       |
|  | 9.8304 Gbps  |        | 9.1       |            | mA       |

| Parameter                   | Test Conditions/Comments                  | Min | Typ   | Max | Unit |
|-----------------------------|---|-----|-------|-----|------|
| VCC1                        | 2.4576 Gbps                               |     | 31.7  |     | mA   |
|                             | 3.072 Gbps                                |     | 16.2  |     | mA   |
|                             | 4.9152 Gbps                               |     | 31.8  |     | mA   |
|                             | 6.144 Gbps                                |     | 16.1  |     | mA   |
|                             | 9.8304 Gbps                               |     | 32.8  |     | mA   |
| TOTAL POWER DISSIPATION     | 0 dB EQ input mode, clock output disabled |     |       |     |      |
|                             | 2.4576 Gbps                               |     | 305.7 |     | mW   |
|                             | 3.072 Gbps                                |     | 249.3 |     | mW   |
|                             | 4.9152 Gbps                               |     | 304.5 |     | mW   |
|                             | 6.144 Gbps                                |     | 287.7 |     | mW   |
|                             | 9.8304 Gbps                               |     | 349.5 |     | mW   |
| OPERATING TEMPERATURE RANGE |   | -40 |       | +85 | °C   |

<sup>1</sup> This typical acquisition specification applies to all selectable reference clock frequencies in the range of 11.05 MHz to 176.8 MHz.

## JITTER SPECIFICATIONS

$T_A = T_{MIN}$  to  $T_{MAX}$ ,  $VCC = VCC_{MIN}$  to  $VCC_{MAX}$ ,  $VCC1 = VCC1_{MIN}$  to  $VCC1_{MAX}$ ,  $VDD = VDD_{MIN}$  to  $VDD_{MAX}$ ,  $VEE = 0$  V, input data pattern = PRBS  $2^{23} - 1$ , ac-coupled to 100  $\Omega$  differential termination load, I<sup>2</sup>C register default settings, unless otherwise noted.

Table 2.

| Parameter                            | Symbol | Test Conditions/Comments                           | Min | Typ  | Max | Unit |
|--------------------------------------|--------|--|-----|------|-----|------|
| TRANSMITTER JITTERS                  |        |  |     |      |     |      |
| Deterministic Jitter                 | T_DJ   | CPRI = 9.8304 Gbps, K28.5 + D5.6 and K28.5 + D16.2 |     | 6.98 |     | ps   |
| Random Jitter                        | T_RJ   | CPRI = 9.8304 Gbps, K28.5 + D5.6 and K28.5 + D16.2 |     | 0.36 |     | ps   |
| Duty Cycle Distortion                | T_DCD  | CPRI = 9.8304 Gbps, K28.5 + D5.6 and K28.5 + D16.2 |     | 0.57 |     | ps   |
| Total Jitter                         | TJ     | SFF-8431, 64B/66B, 10.3125 Gbps                    |     | 13.6 |     | ps   |
| Data Dependent Jitter                | DDJ    | SFF-8431, PRBS $2^9 - 1$ , 10.3125 Gbps            |     | 7.37 |     | ps   |
| Data Dependent Pulse Width Shrinkage | DDPWS  | SFF-8431, PRBS $2^9 - 1$ , 10.3125 Gbps            |     | 4.58 |     | ps   |
| Uncorrelated Jitter                  | UJ     | SFF-8431, 64B/66B, 10.3125 Gbps                    |     | 0.14 |     | ps   |
| RECEIVER JITTERS                     |        |  |     |      |     |      |
| Total Jitter Tolerance               | TJT    | SFF-8431, 10.3125 Gbps                             |     | 82.4 |     | ps   |
| 99% Jitter                           | J2     | SFF-8431, 10.3125 Gbps                             |     | 55.5 |     | ps   |
| Data Dependent Pulse Width Shrinkage | DDPWS  | SFF-8431, 10.3125 Gbps                             |     | 33.7 |     | ps   |

**OUTPUT AND TIMING SPECIFICATIONS**

$T_A = T_{MIN}$  to  $T_{MAX}$ ,  $VCC = VCC_{MIN}$  to  $VCC_{MAX}$ ,  $VCC1 = VCC1_{MIN}$  to  $VCC1_{MAX}$ ,  $VDD = VDD_{MIN}$  to  $VDD_{MAX}$ ,  $VEE = 0$  V, input data pattern = PRBS  $2^{23} - 1$ , ac-coupled to 100  $\Omega$  differential termination load, I<sup>2</sup>C register default settings, unless otherwise noted.

**Table 3.**

| Parameter   | Symbol       | Test Conditions/Comments                               | Min               | Typ           | Max          | Unit    |
|---|--------------|--|-------------------|---------------|--------------|---------|
| <b>CML OUTPUT CHARACTERISTICS</b>                           |              |  |                   |               |              |         |
| Data Differential Output Swing                              |              | 9.8304 Gbps, DATA_SWING[3:0] = 0xC (default)           | 535               | 600           | 672          | mV p-p  |
|   |              | 9.8304 Gbps, DATA_SWING[3:0] = 0xF (maximum)           | 668               | 724           | 771          | mV p-p  |
|   |              | 9.8304 Gbps, DATA_SWING[3:0] = 0x4 (minimum)           | 189               | 219           | 252          | mV p-p  |
| Output Voltage  |              |  |                   |               |              |         |
| High  | $V_{OH}$     | DC-coupled   | $VCC - 0.05$      | $VCC - 0.025$ | $VCC$        | V       |
| Low   | $V_{OL}$     | DC-coupled   | $VCC - 0.36$      | $VCC - 0.325$ | $VCC - 0.29$ | V       |
| <b>CML OUTPUT TIMING CHARACTERISTICS</b>                    |              |  |                   |               |              |         |
| Rise Time   |              | 20% to 80%, at 9.8304 Gbps, DATOUTN/DATOUTP            | 17.4              | 32.6          | 46.5         | ps      |
|   |              | 20% to 80%, at 9.8304 Gbps, CLKOUTN/CLKOUTP            | 22.2              | 28.3          | 33.1         | ps      |
| Fall Time   |              | 80% to 20%, at 9.8304 Gbps, DATOUTN/DATOUTP            | 17.5              | 33            | 49.1         | ps      |
|   |              | 80% to 20%, at 9.8304 Gbps, CLKOUTN/CLKOUTP            | 23.9              | 29.2          | 33.7         | ps      |
| Setup Time, Full Rate Clock                                 | $t_S$        | See Figure 2   |                   | 0.5           |              | UI      |
| Hold Time, Full Rate Clock                                  | $t_H$        | See Figure 2   |                   | 0.5           |              | UI      |
| Setup Time, DDR Mode  | $t_S$        | See Figure 3   |                   | 0.5           |              | UI      |
| Hold Time, DDR Mode   | $t_H$        | See Figure 3   |                   | 0.5           |              | UI      |
| <b>I<sup>2</sup>C INTERFACE DC CHARACTERISTICS</b>          |              |  |                   |               |              |         |
| Input Voltage   |              | LVTTL  |                   |               |              |         |
| High  | $V_{IH}$     |  | 2.0               |               |              | V       |
| Low   | $V_{IL}$     |  |                   |               | 0.8          | V       |
| Input Current   |              | $V_{IN} = 0.1 \times VDD$ or $V_{IN} = 0.9 \times VDD$ | -10.0             |               | +10.0        | $\mu$ A |
| Output Low Voltage  | $V_{OL}$     | $I_{OL} = 3.0$ mA                                      |                   |               | 0.4          | V       |
| <b>I<sup>2</sup>C INTERFACE TIMING</b>                      |              |  |                   |               |              |         |
| SCK Clock Frequency   |              | See Figure 14  |                   |               | 400          | kHz     |
| SCK Pulse Width High  | $t_{HIGH}$   |  | 600               |               |              | ns      |
| SCK Pulse Width Low   | $t_{LOW}$    |  | 1300              |               |              | ns      |
| Start Condition Hold Time                                   | $t_{HD,STA}$ |  | 600               |               |              | ns      |
| Start Condition Setup Time                                  | $t_{SU,STA}$ |  | 600               |               |              | ns      |
| Data Setup Time   | $t_{SU,DAT}$ |  | 100               |               |              | ns      |
| Data Hold Time  | $t_{HD,DAT}$ |  | 300               |               |              | ns      |
| SCK/SDA Rise/Fall Time <sup>1</sup>                         | $t_R/t_F$    |  | 20 +<br>0.1 $C_b$ |               | 300          | ns      |
| Stop Condition Setup Time                                   | $t_{SU,STO}$ |  | 600               |               |              | ns      |
| Bus Free Time Between Stop and Start Conditions             | $t_{BUF}$    |  | 1300              |               |              | ns      |
| <b>LVTTL DC INPUT CHARACTERISTICS (I<sup>2</sup>C_ADDR)</b> |              |  |                   |               |              |         |
| Input Voltage   |              |  |                   |               |              |         |
| High  | $V_{IH}$     |  | 2.0               |               |              | V       |
| Low   | $V_{IL}$     |  |                   |               | 0.8          | V       |
| Input Current   |              |  |                   |               |              |         |
| High  | $I_{IH}$     | $V_{IN} = 2.4$ V                                       |                   |               | 5            | $\mu$ A |
| Low   | $I_{IL}$     | $V_{IN} = 0.4$ V                                       | -5                |               |              | $\mu$ A |
| <b>LVTTL DC OUTPUT CHARACTERISTICS (LOS/LOL)</b>            |              |  |                   |               |              |         |
| Output Voltage  |              |  |                   |               |              |         |
| High  | $V_{OH}$     | $I_{OH} = 2.0$ mA                                      | 2.4               |               |              | V       |
| Low   | $V_{OL}$     | $I_{OL} = -2.0$ mA                                     |                   |               | 0.4          | V       |

| Parameter                               | Symbol   | Test Conditions/Comments  | Min   | Typ | Max   | Unit   |
|---|----------|---|-------|-----|-------|--------|
| REFERENCE CLOCK CHARACTERISTICS         |          |   |       |     |       |        |
| Input Compliance Voltage (Single-Ended) | $V_{CM}$ | Optional LTR mode<br>No input offset, no input current, see Figure 21, ac-coupled input | 0.55  |     | 1.0   | V      |
| Minimum Differential Input Drive        |          | See Figure 21, ac-coupled, differential input   |       | 100 |       | mV p-p |
| Reference Frequency                     |          |   | 11.05 |     | 176.8 | MHz    |
| Required Accuracy <sup>2</sup>          |          | AC-coupled, differential input  |       | 100 |       | ppm    |

<sup>1</sup>  $C_b$  is the total capacitance of one bus line in picofarads (pF). If mixed with high speed (HS) mode devices, faster rise/fall times are allowed (refer to the Philips *I<sup>2</sup>C Bus Specification, Version 2.1*).

<sup>2</sup> Required accuracy in dc-coupled mode is guaranteed by design as long as the clock common-mode voltage output matches the reference clock common-mode voltage range.

**TIMING DIAGRAMS**

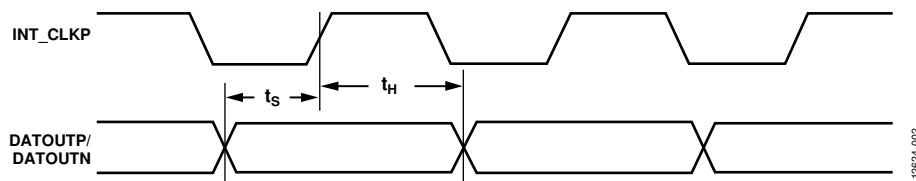

Figure 2. Data to Clock Timing (Full Rate Clock Mode)

12824-002

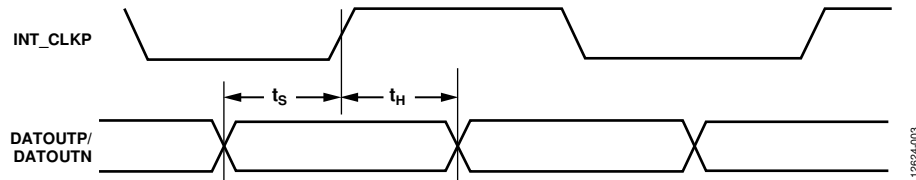

Figure 3. Data to Clock Timing (Half-Rate Clock/DDR Mode)

12824-003

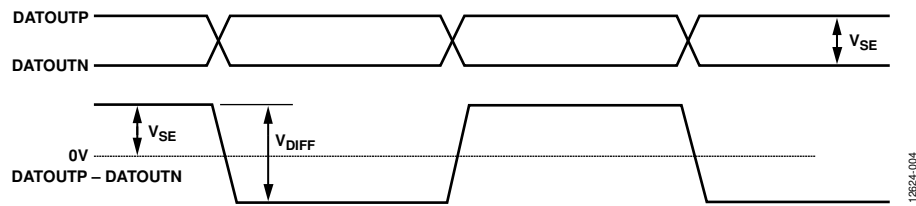

Figure 4. Single-Ended vs. Differential Output Amplitude Relationship

12824-004



## ABSOLUTE MAXIMUM RATINGS

Table 4.

| Parameter   | Rating          |
|---|-----------------|
| Supply Voltage (VCC = 1.2 V)                            | 1.26 V          |
| Supply Voltage (VDD and VCC1 = 3.3 V)                   | 3.63 V          |
| Maximum Input Voltage (REFCLKP/REFCLKN, NIN/PIN)        | 1.26 V          |
| Minimum Input Voltage (REFCLKP/REFCLKN, NIN/PIN)        | VEE – 0.4 V     |
| Maximum Input Voltage (SDA, SCK, I <sup>2</sup> C_ADDR) | 3.63 V          |
| Minimum Input Voltage (SDA, SCK, I <sup>2</sup> C_ADDR) | VEE – 0.4 V     |
| Maximum Junction Temperature                            | 125°C           |
| Storage Temperature Range                               | –65°C to +150°C |
| Lead Temperature (Soldering, 10 sec)                    | 300°C           |

Stresses at or above those listed under Absolute Maximum Ratings may cause permanent damage to the product. This is a stress rating only; functional operation of the product at these or any other conditions above those indicated in the operational section of this specification is not implied. Operation beyond the maximum operating conditions for extended periods may affect product reliability.

## THERMAL CHARACTERISTICS

### Thermal Resistance

Thermal resistance is specified for the worst-case conditions, that is, a device soldered in a circuit board for surface-mount packages, for a 4-layer board with the exposed paddle soldered to VEE.

Table 5. Thermal Resistance

| Package Type  | $\theta_{JA}$ <sup>1</sup> | $\theta_{JB}$ <sup>2</sup> | $\theta_{JC}$ <sup>3</sup> | Unit |
|---------------|----------------------------|----------------------------|----------------------------|------|
| 24-Lead LFCSP | 45                         | 5                          | 11                         | °C/W |

<sup>1</sup> Junction to ambient.

<sup>2</sup> Junction to base.

<sup>3</sup> Junction to case.

## ESD CAUTION



**ESD (electrostatic discharge) sensitive device.** Charged devices and circuit boards can discharge without detection. Although this product features patented or proprietary protection circuitry, damage may occur on devices subjected to high energy ESD. Therefore, proper ESD precautions should be taken to avoid performance degradation or loss of functionality.

## PIN CONFIGURATION AND FUNCTION DESCRIPTIONS

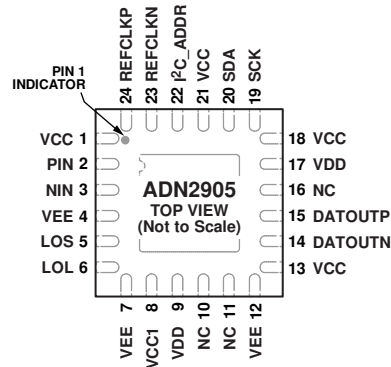

## NOTES

1. NC = NO CONNECT. DO NOT CONNECT TO THIS PIN.
2. EXPOSED PAD ON BOTTOM OF THE PACKAGE MUST BE CONNECTED TO VEE ELECTRICALLY.

13624-005

Figure 5. Pin Configuration

Table 6. Pin Function Descriptions

| Pin No. | Mnemonic              | Type <sup>1</sup> | Description   |
|---------|-----------------------|-------------------|---|
| 1       | VCC                   | P                 | 1.2 V Supply for Limiting Amplifier.  |
| 2       | PIN                   | AI                | Positive Differential Data Input (CML).   |
| 3       | NIN                   | AI                | Negative Differential Data Input (CML).   |
| 4       | VEE                   | P                 | Ground for Limiting Amplifier.  |
| 5       | LOS                   | DO                | Loss of Signal Output (Active High).  |
| 6       | LOL                   | DO                | Loss of Lock Output (Active High).  |
| 7       | VEE                   | P                 | Digital Control Oscillator (DCO) Ground.  |
| 8       | VCC1                  | P                 | 1.8 V to 3.3 V DCO Supply.  |
| 9       | VDD                   | P                 | 3.3 V High Supply.  |
| 10      | NC                    | N/A               | No Connect. Do not connect to this pin. Leave this pin floating   |
| 11      | NC                    | N/A               | No Connect. Do not connect to this pin. Leave this pin floating   |
| 12      | VEE                   | P                 | Ground for CML Output Drivers.  |
| 13      | VCC                   | P                 | 1.2 V Supply for CML Output Drivers.  |
| 14      | DATOUTN               | DO                | Negative Differential Retimed Data Output (CML).  |
| 15      | DATOUTP               | DO                | Positive Differential Retimed Data Output (CML).  |
| 16      | NC                    | DI                | No Connect. Tie this pin to VEE (ground).   |
| 17      | VDD                   | P                 | 3.3 V High Supply.  |
| 18      | VCC                   | P                 | 1.2 V Core Digital Supply.  |
| 19      | SCK                   | DI                | Clock for I <sup>2</sup> C.   |
| 20      | SDA                   | DIO               | Bidirectional Data for I <sup>2</sup> C.  |
| 21      | VCC                   | P                 | 1.2 V Core Supply.  |
| 22      | I <sup>2</sup> C_ADDR | DI                | I <sup>2</sup> C Address Setting. Sets the device I <sup>2</sup> C address to 0x80 when I <sup>2</sup> C_ADDR = 0. Sets the device I <sup>2</sup> C address to 0x82 when I <sup>2</sup> C_ADDR = 1. |
| 23      | REFCLKN               | DI                | Negative Reference Clock Input (Optional).  |
| 24      | REFCLKP               | DI                | Positive Reference Clock Input (Optional).  |
| N/A     | EPAD                  | P                 | Exposed Pad (VEE). The exposed pad on the bottom of the device package must be connected to VEE electrically. The exposed pad works as a heat sink.   |

<sup>1</sup> P is power, AI is analog input, DI is digital input, DO is digital output, DIO is digital input/output, and N/A is not applicable.

### TYPICAL PERFORMANCE CHARACTERISTICS

$T_A = 25^\circ\text{C}$ ,  $V_{CC} = 1.2\text{ V}$ ,  $V_{CC1} = 1.8\text{ V}$ ,  $V_{DD} = 3.3\text{ V}$ ,  $V_{EE} = 0\text{ V}$ , input data pattern = PRBS  $2^{15} - 1$ , ac-coupled inputs and outputs, unless otherwise noted.

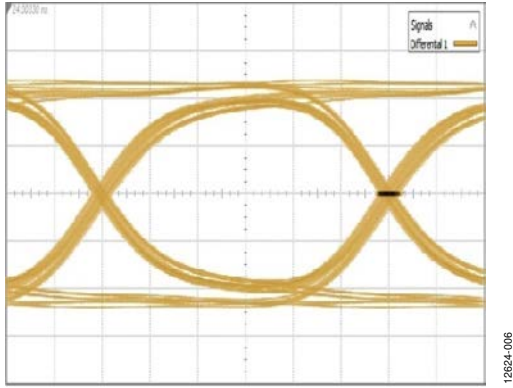

Figure 6. Output Eye Diagram at  $CPRI \times 16 = 9.8304\text{ Gbps}$ ,  
Time = 16.95 ps/div, Amplitude = 116 mV/div

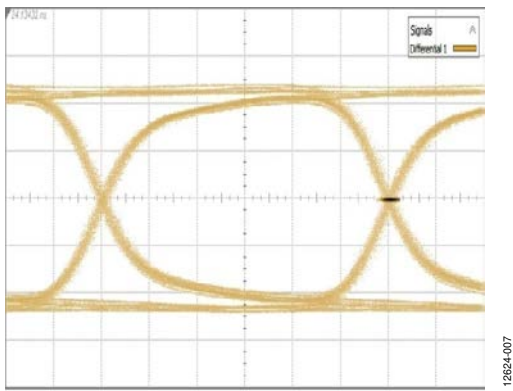

Figure 7. Output Eye Diagram at  $CPRI \times 12 = 6.144\text{ Gbps}$ ,  
Time = 27.13 ps/div, Amplitude = 118 mV/div

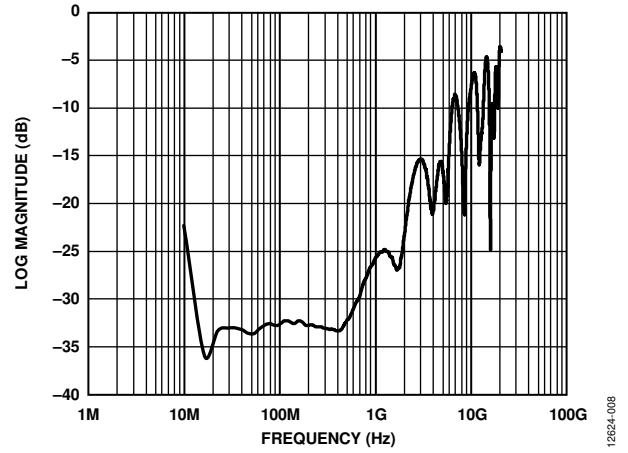

Figure 8. Typical S11 Spectrum Performance

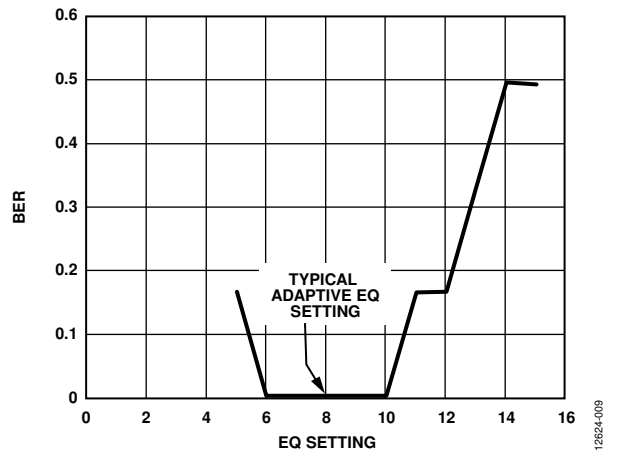

Figure 9. BER in Equalizer Mode vs. EQ Compensation at  $CPRI \times 16 = 9.8304\text{ Gbps}$  (with a Signal of 400 mV p-p Differential, on 15 inch FR4 Traces, with Variant EQ Compensation, Including Adaptive EQ)

# I<sup>2</sup>C INTERFACE TIMING AND INTERNAL REGISTER DESCRIPTIONS

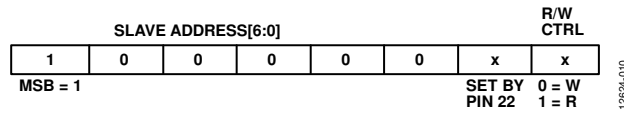

Figure 10. Slave Address Configuration

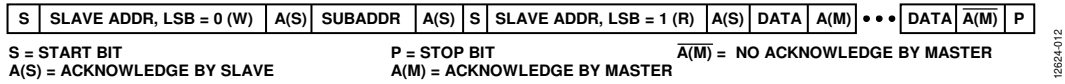
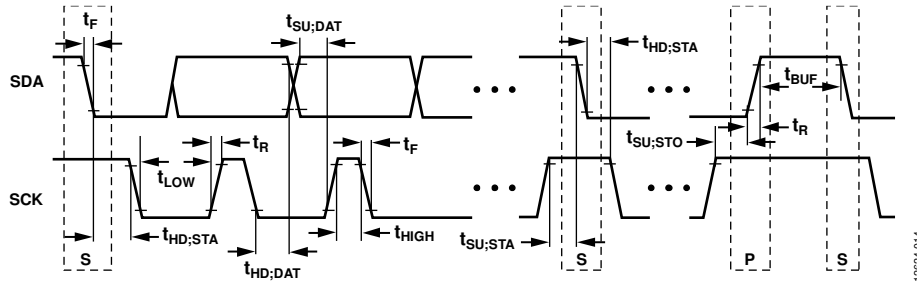
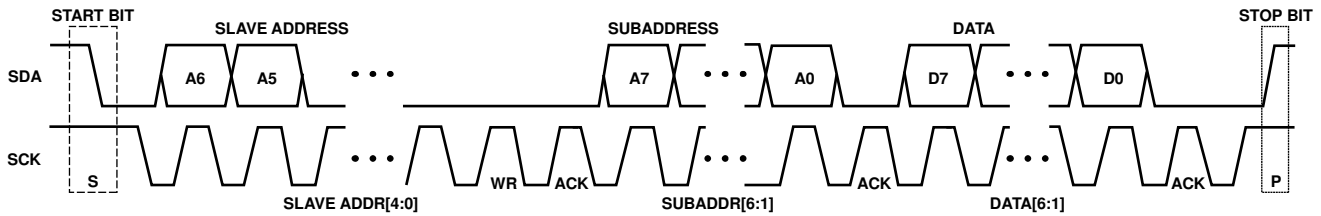

Figure 11. I<sup>2</sup>C Read Data Transfer



Figure 12. I<sup>2</sup>C Write Data Transfer



## REGISTER MAP

Writing to register bits other than those clearly labeled is not recommended and may cause unintended results.

**Table 7. Internal Register Map**<sup>1,2</sup>

| Reg. Name       | R/W | Addr. (Hex) | Default (Hex) | D7                            | D6             | D5              | D4             | D3                     | D2                   | D1                      | D0              |  |
|-----------------|-----|-------------|---------------|-------------------------------|----------------|-----------------|----------------|------------------------|----------------------|-------------------------|-----------------|--|
| Readback/Status |     |             |               |                               |                |                 |                |                        |                      |                         |                 |  |
| FREQMEAS0       | R   | 0x0         | N/A           | FREQ0[7:0] (RATE_FREQ[7:0])   |                |                 |                |                        |                      |                         |                 |  |
| FREQMEAS1       | R   | 0x1         | N/A           | FREQ1[7:0] (RATE_FREQ[15:8])  |                |                 |                |                        |                      |                         |                 |  |
| FREQMEAS2       | R   | 0x2         | N/A           | FREQ2[7:0] (RATE_FREQ[23:16]) |                |                 |                |                        |                      |                         |                 |  |
| FREQ_RB1        | R   | 0x4         | N/A           | VCOSEL[7:0]                   |                |                 |                |                        |                      |                         |                 |  |
| FREQ_RB2        | R   | 0x5         | N/A           | X                             | FULLRATE       | DIVRATE[3:0]    |                |                        |                      | VCOSEL[9:8]             |                 |  |
| STATUSA         | R   | 0x6         | N/A           | X                             | X              | Reserved        | LOL status     | Reserved               | Static LOL           | X                       | RATE_MEAS_COMP  |  |
| General Control |     |             |               |                               |                |                 |                |                        |                      |                         |                 |  |
| CTRLA           | R/W | 0x8         | 0x10          | 0                             | CDR_MODE[2:0]  |                 |                | 0                      | Reset static LOL     | RATE_MEAS_EN            | RATE_MEAS_RESET |  |
| CTRLB           | R/W | 0x9         | 0x08          | SOFTWARE_RESET                | INIT_FREQ_ACQ  | CDR bypass      | LOL config     | 1                      | Reserved             | 0                       | 0               |  |
| CTRLC           | R/W | 0xA         | 0x05          | 0                             | 0              | 0               | 0              | 0                      | REFCLK_PDN           | 0                       | 1               |  |
| FLL Control     |     |             |               |                               |                |                 |                |                        |                      |                         |                 |  |
| LTR_MODE        | R/W | 0xF         | 0x00          | 0                             | LOL data       | FREF_RANGE[1:0] |                | DATA_TO_REF_RATIO[3:0] |                      |                         |                 |  |
| DPLL Control    |     |             |               |                               |                |                 |                |                        |                      |                         |                 |  |
| DPLLA           | R/W | 0x10        | 0x1C          | 0                             | 0              | 0               | EDGE_SEL[1:0]  |                        | TRANBW[2:0]          |                         |                 |  |
| DPLLD           | R/W | 0x13        | 0x02          | 0                             | 0              | 0               | 0              | 0                      | Reserved to 0        | DLL_SLEW[1:0]           |                 |  |
| Phase           | R/W | 0x14        | 0x00          | 0                             | 0              | 0               | 0              | SAMPLE_PHASE[3:0]      |                      |                         |                 |  |
| LA_EQ           | R/W | 0x16        | 0x08          | RX_TERM_FLOAT                 | INPUT_SEL[1:0] |                 | ADAPTIVE_EQ_EN | EQ_BOOST[3:0]          |                      |                         |                 |  |
| Output Control  |     |             |               |                               |                |                 |                |                        |                      |                         |                 |  |
| OUTPUTA         | R/W | 0x1E        | 0x00          | 0                             | 0              | Data squelch    | DATOUT_DISABLE | 1                      | DDR_DISABLE          | DATA_POLARITY           | Reserved        |  |
| OUTPUTB         | R/W | 0x1F        | 0xCC          | DATA_SWING[3:0]               |                |                 |                | Reserved               |                      |                         |                 |  |
| PRBS Control    |     |             |               |                               |                |                 |                |                        |                      |                         |                 |  |
| PRBS Gen 1      | R/W | 0x39        | 0x00          | 0                             | 0              | DATA_CID_BIT    | DATA_CID_EN    | 0                      | DATA_GEN_EN          | DATA_GEN_MODE[1:0]      |                 |  |
| PRBS Gen 2      | R/W | 0x3A        | 0x00          | DATA_CID_LENGTH[7:0]          |                |                 |                |                        |                      |                         |                 |  |
| PRBS Gen 3      | R/W | 0x3B        | 0x00          | PROG_DATA[7:0]                |                |                 |                |                        |                      |                         |                 |  |
| PRBS Gen 4      | R/W | 0x3C        | 0x00          | PROG_DATA[15:8]               |                |                 |                |                        |                      |                         |                 |  |
| PRBS Gen 5      | R/W | 0x3D        | 0x00          | PROG_DATA[23:16]              |                |                 |                |                        |                      |                         |                 |  |
| PRBS Gen 6      | R/W | 0x3E        | 0x00          | PROG_DATA[31:24]              |                |                 |                |                        |                      |                         |                 |  |
| PRBS Rec 1      | R/W | 0x3F        | 0x00          | 0                             | 0              | 0               | 0              | DATA_RECEIVER_CLEAR    | DATA_RECEIVER_ENABLE | DATA_RECEIVER_MODE[1:0] |                 |  |
| PRBS Rec 2      | R   | 0x40        | 0x00          | PRBS_ERROR_COUNT[7:0]         |                |                 |                |                        |                      |                         |                 |  |
| PRBS Rec 3      | R   | 0x41        | 0x00          | PRBS_ERROR                    |                |                 |                |                        |                      |                         |                 |  |
| PRBS Rec 4      | R   | 0x42        | N/A           | DATA_LOADED[7:0]              |                |                 |                |                        |                      |                         |                 |  |
| PRBS Rec 5      | R   | 0x43        | N/A           | DATA_LOADED[15:8]             |                |                 |                |                        |                      |                         |                 |  |
| PRBS Rec 6      | R   | 0x44        | N/A           | DATA_LOADED[23:16]            |                |                 |                |                        |                      |                         |                 |  |
| PRBS Rec 7      | R   | 0x45        | N/A           | DATA_LOADED[31:24]            |                |                 |                |                        |                      |                         |                 |  |

| Reg. Name   | R/W | Addr. (Hex) | Default (Hex) | D7 | D6 | D5 | D4 | D3 | D2 | D1 | D0       |
|-------------|-----|-------------|---------------|----|----|----|----|----|----|----|----------|
| ID/Revision |     |             |               |    |    |    |    |    |    |    |          |
| REV         | R   | 0x48        | 0x54          |    |    |    |    |    |    |    | Rev[7:0] |
| ID          | R   | 0x49        | 0x15          |    |    |    |    |    |    |    | ID[7:0]  |
| HI_CODE     | R   | 0x20        | 0xAD          |    |    |    |    |    |    |    | Reserved |
| LO_CODE     | R   | 0x21        | 0x63          |    |    |    |    |    |    |    | Reserved |

<sup>1</sup> X means don't care.

<sup>2</sup> N/A means not applicable.

**Table 8. Status Register, STATUSA (Address 0x6)**

| Bit(s) | Bit Name       | Bit Description  |
|--------|----------------|--|
| D5     | Reserved       | X  |
| D4     | LOL status     | 0 = locked<br>1 = frequency acquisition mode   |
| D3     | Reserved       | X  |
| D2     | Static LOL     | 0 = no LOL event since last reset<br>1 = LOL event since last reset; clear using the reset static LOL bit                                    |
| D0     | RATE_MEAS_COMP | Rate measurement complete<br>0 = frequency measurement incomplete<br>1 = frequency measurement complete; clear using the RATE_MEAS_RESET bit |

**Table 9. Control Register, CTRLA (Address 0x8)**

| Bit(s)  | Bit Name         | Bit Description  |
|---------|------------------|--|
| D7      | Reserved         | Reserved to 0.   |
| [D6:D4] | CDR_MODE[2:0]    | CDR modes.<br>000 = lock to data (LTD).<br>010 = lock to reference (LTR).<br>001, 011 = reserved.  |
| D3      | Reserved         | Reserved to 0.   |
| D2      | Reset static LOL | In factory default mode, this bit is set to 0. In the static LOL mode, write 1 and then write 0 to clear static LOL bit (D2 of the status register). |
| D1      | RATE_MEAS_EN     | Fine data rate measurement enable. Set to 1 to initiate a rate measurement.  |
| D0      | RATE_MEAS_RESET  | Rate measurement reset. Set to 1 to clear a rate measurement.  |

**Table 10. Control Register, CTRLB (Address 0x9)**

| Bit(s)  | Bit Name       | Bit Description   |
|---------|----------------|---|
| D7      | SOFTWARE_RESET | Software reset. Write a 1 followed by a 0 to reset the device.  |
| D6      | INIT_FREQ_ACQ  | Initiate frequency acquisition. Write a 1 followed by a 0 to initiate a frequency acquisition (optional). |
| D5      | CDR bypass     | CDR bypass.<br>0 = CDR enabled.<br>1 = CDR bypassed.  |
| D4      | LOL config     | LOL configuration.<br>0 = normal LOL.<br>1 = static LOL.  |
| D3      | Reserved       | Reserved to 1.  |
| D2      | Reserved       | Reserved to 0.  |
| [D1:D0] | Reserved       | Reserved to 0.  |

Table 11. Control Register, CTRLC (Address 0xA)

| Bit(s)  | Bit Name   | Bit Description  |
|---------|------------|--|
| [D7:D3] | Reserved   | Reserved to 0.   |
| D2      | REFCLK_PDN | Reference clock power-down. Write a 0 to enable the reference clock. |
| D1      | Reserved   | Reserved to 0.   |
| D0      | Reserved   | Reserved to 1.   |

Table 12. Lock to Reference Clock Mode Programming Register, LTR\_MODE<sup>1</sup> (Address 0xF)

| Bit(s)  | Bit Name               | Bit Description   |
|---------|------------------------|---|
| D7      | Reserved               | Reserved to 0   |
| D6      | LOL data               | LOL data<br>0 = CLK vs. reference clock during tracking<br>1 = CLK vs. data during tracking   |
| [D5:D4] | FREF_RANGE[1:0]        | $f_{REF}$ range<br>00 = 11.05 MHz to 22.1 MHz<br>01 = 22.1 MHz to 44.2 MHz<br>10 = 44.2 MHz to 88.4 MHz<br>11 = 88.4 MHz to 176.8 MHz |
| [D3:D0] | DATA_TO_REF_RATIO[3:0] | Data to reference ratio<br>0000 = $\frac{1}{2}$<br>0001 = 1<br>0010 = 2<br>$N = 2^{(n-1)}$<br>1010 = 512                              |

<sup>1</sup> Where  $DIV_{f_{REF}}$  is the divided down reference referred to the 11.05 MHz to 22.1 MHz band (see the Reference Clock (Optional) section).  $Data Rate / 2^{(LTR\_MODE[3:0] - 1)} = REFCLK / 2^{LTR\_MODE[5:4]}$

Table 13. DPLL Control Register, DPLLA (Address 0x10)

| Bit(s)  | Bit Name      | Bit Description   |
|---------|---------------|---|
| [D7:D5] | Reserved      | Reserved to 0.  |
| [D4:D3] | EDGE_SEL[1:0] | Edge for phase detection. See the Edge Select section for further details.<br>00 = rising and falling edge data.<br>01 = rising edge data.<br>10 = falling edge data.<br>11 = rising and falling edge data.   |
| [D2:D0] | TRANBW[2:0]   | Transfer bandwidth. Scales transfer bandwidth. Default value is 4, resulting in the CPRI $\times$ 16: 9.8304 Gbps default BW shown in Table 2. See the Transfer Bandwidth section for further details.<br>$Transfer\ BW = Default\ Transfer\ BW \times (TRANBW[2:0]/4)$ |

Table 14. DPLL Control Register, DPLLD (Address 0x13)

| Bit(s)  | Bit Name      | Bit Description   |
|---------|---------------|---|
| [D7:D2] | Reserved      | Reserved to 0.  |
| [D1:D0] | DLL_SLEW[1:0] | DLL slew. Sets the BW of the DLL. See the DLL Slew section for further details. |

Table 15. Phase Control Register, Phase (Address 0x14)

| Bit(s)  | Bit Name          | Bit Description  |
|---------|-------------------|--|
| [D7:D4] | Reserved          | Reserved to 0.   |
| [D3:D0] | SAMPLE_PHASE[3:0] | Adjusts the phase of the sampling instant for data rates above 5.65 Gbps in steps of 1/32 UI. This register is in twos complement notation. See the Sample Phase Adjust section for further details. |

Table 16. Input Stage Programming Register, LA\_EQ (Address 0x16)

| Bit(s)  | Bit Name       | Bit Description   |
|---------|----------------|---|
| D7      | RX_TERM_FLOAT  | Receiver (Rx) termination float.<br>0 = termination common-mode driven.<br>1 = termination common-mode floated. |
| [D6:D5] | INPUT_SEL[1:0] | Input stage select.<br>01 = equalizer.<br>10 = 0 dB EQ mode.<br>00, 11 = undefined.                             |
| D4      | ADAPTIVE_EQ_EN | Enable adaptive EQ.<br>0 = manual EQ control.<br>1 = adaptive EQ enabled.                                       |
| [D3:D0] | EQ_BOOST[3:0]  | Equalizer gain. These bits set the EQ gain. See the Passive Equalizer section for further details.              |

Table 17. Output Control Register, OUTPUTA (Address 0x1E)

| Bit(s)  | Bit Name       | Bit Description  |
|---------|----------------|--|
| [D7:D6] | Reserved       | Reserved to 0  |
| D5      | Data squelch   | Squelch<br>0 = normal data<br>1 = squelch data                             |
| D4      | DATOUT_DISABLE | Data output disable<br>0 = data output enabled<br>1 = data output disabled |
| D3      | Reserved       | Reserved to 1  |
| D2      | DDR_DISABLE    | Double data rate<br>0 = DDR clock enabled<br>1 = DDR clock disabled        |
| D1      | DATA_POLARITY  | Data polarity<br>0 = normal data polarity<br>1 = flip data polarity        |
| D0      | Reserved       | Reserved to 0  |

Table 18. Output Swing Register, OUTPUTB (Address 0x1F)

| Bit(s)  | Bit Name        | Bit Description   |
|---------|-----------------|---|
| [D7:D4] | DATA_SWING[3:0] | Adjust data output amplitude. Step size is approximately 50 mV differential. Default register value is 0xCH. Typical differential data output amplitudes are<br>0x1 to 0x3 = invalid.<br>0x4 = 200 mV.<br>0x5 = 250 mV.<br>0x6 = 300 mV.<br>0x7 = 345 mV.<br>0x8 = 390 mV.<br>0x9 = 440 mV.<br>0xA = 485 mV.<br>0xB = 530 mV.<br>0xC = 575 mV.<br>0xD = 610 mV.<br>0xE = 640 mV.<br>0xF = 655 mV. |
| [D3:D0] | Reserved        | Default = 0xCH.   |



## THEORY OF OPERATION

The ADN2905 implements a data recovery for CPRI data rates from 614.4 Mbps to 9.8304 Gbps. The front end is configurable to either equalize or 0 dB EQ the nonreturn-to-zero (NRZ) input waveform to full-scale digital logic levels, or to pass a full digital logic signal.

The user can choose from two input stages to process the data: a high-pass passive equalizer with up to 10 dB of boost at 5 GHz, or 0 dB EQ mode with approximately 250 mV p-p sensitivity at CPRI rate 9.8304 Gbps.

When the input signal is corrupted due to FR-4 or other impairments in the printed circuit board (PCB) traces, a passive equalizer can be one of the signal integrity options. The equalizer high frequency boost is configurable through the I<sup>2</sup>C registers, in place of the factory default settings. A user enabled adaptation is included that automatically adjusts the equalizer to achieve the widest eye opening. The equalizer can be manually set for any data rate, but adaptation is available only at data rates greater than 5.5 Gbps.

When a signal is presented to the data recovery, the ADN2905 acts as a delay-locked and phase-locked loop (PLL) circuit for clock recovery and data retiming from an NRZ encoded data stream. Input data is sampled by a high speed clock. A digital downsampler accommodates data rates spanning three orders of magnitude. Downsampled data is applied to a binary phase detector.

The phase of the input data signal is tracked by two separate feedback loops. A high speed, delay-locked loop (DLL) path cascades a digital integrator with a digitally controlled phase shifter on the digital control oscillator (DCO) clock to track the high frequency components of jitter. A separate phase control loop, composed of a digital integrator and DCO, tracks the low frequency components of jitter. The initial frequency of the DCO is set by a third loop that compares the DCO frequency with the input data frequency. This third loop also sets the decimation ratio of the digital downsampler.

The delay-locked and phase-locked loops together track the phase of the input data. For example, when the clock lags the input data, the phase detector drives the DCO to a higher frequency and decreases the delay of the clock through the phase shifter; both of these actions reduce the phase error between the clock and data. Because the loop filter is an integrator, the static phase error is driven to zero.

Another view of the circuit is that the phase shifter implements the zero required for frequency compensation of a second-order phase-locked loop, and this zero is placed in the feedback path and, therefore, does not appear in the closed-loop transfer function. Because this circuit has no zero in the closed-loop transfer, jitter peaking is eliminated.

The delay-locked and phase-locked loops simultaneously provide wideband jitter accommodation and narrow-band jitter filtering. The simplified block diagram in Figure 15 shows that Z(s)/X(s) is a second-order, low-pass jitter transfer function that provides excellent filtering. The low frequency pole is formed by dividing the gain of the PLL by the gain of the DLL, where the upsampling and zero-order hold in the DLL has a gain approaching N at the transfer bandwidth of the loop. Note that the jitter transfer has no zero, unlike an ordinary, second-order phase-locked loop, which means that the main PLL has no jitter peaking. This no jitter peaking feature makes the circuit ideal for signal regenerator applications where jitter peaking in a cascade of regenerators can contribute to hazardous jitter accumulation.

The error transfer, e(s)/X(s), has the same high-pass form as an ordinary phase-locked loop up to the slew rate limit of the DLL with a binary phase detector. This transfer function is free to be optimized to give excellent wideband jitter accommodation because the jitter transfer function, Z(s)/X(s), provides the narrow-band jitter filtering.

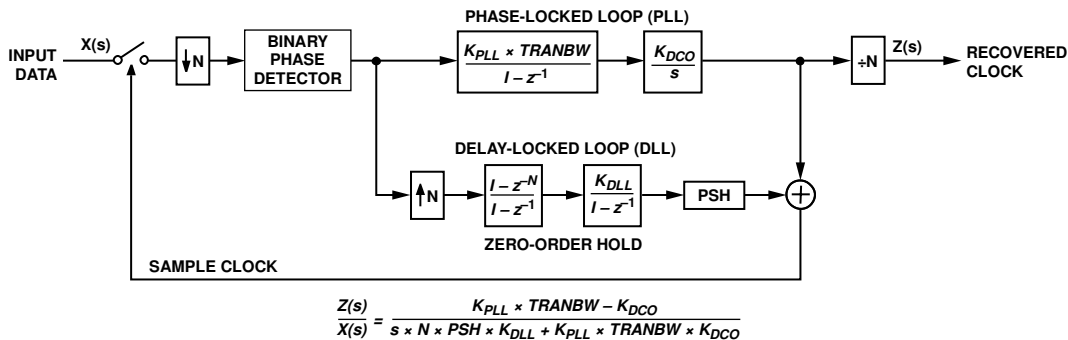

Figure 15. CDR Jitter Block Diagram

12824-015

The delay-locked and phase-locked loops contribute to overall jitter accommodation. At low frequencies of input jitter on the data signal, the integrator in the loop filter provides high gain to track large jitter amplitudes with small phase error. In this case, the oscillator is frequency modulated, and jitter is tracked as in an ordinary phase-locked loop. The amount of low frequency jitter that can be tracked is a function of the DCO tuning range. A wider tuning range provides more accommodation of low frequency jitter. The internal loop control word remains small for small jitter frequency, so that the phase shifter remains close to the center of its range and, therefore, contributes little to the low frequency jitter accommodation.

At medium jitter frequencies, the gain and tuning range of the DCO are not large enough to track input jitter. In this case, the DCO control word becomes large and saturates. As a result, the DCO frequency remains at an extreme of its tuning range. The

size of the DCO tuning range, therefore, has only a small effect on the jitter accommodation. The delay-locked loop control range is larger; therefore, the phase shifter tracks the input jitter. An infinite range phase shifter is used on the clock. Consequently, the minimum range of timing mismatch between the clock at the data sampler and the retiming clock at the output is limited by the depth of the FIFO to 32 UI.

There are two ways to acquire the data rate. The default mode is for the frequency to lock to the input data, where a finite state machine extracts frequency measurements from the data to program the DCO and loop division ratio so that the sampling frequency matches the data rate to within 250 ppm. The PLL is enabled, driving this frequency difference to 0 ppm. The second mode is to lock to reference (LTR), in which case the user provides a reference clock between 11.05 MHz and 176.8 MHz. Division ratios must be written to a serial port register.

## FUNCTIONAL DESCRIPTION

### FREQUENCY ACQUISITION

The ADN2905 acquires its frequency from the data over a range of data frequencies from 614.4 Mbps to 9.8304 Gbps. The lock detector circuit compares the frequency of the DCO and the frequency of the incoming data. When these frequencies differ by more than 1000 ppm, the LOL pin is asserted, and a new frequency acquisition cycle is initiated. The DCO frequency is reset to the lowest point of its range, and the internal division rate is set to its lowest value of  $N = 1$ , which is the highest octave of data rates. The frequency detector then compares this sampling rate frequency to the data rate frequency and either increases  $N$  by a factor of 2 if the sampling rate frequency is greater than the data rate frequency, or increases the DCO frequency if the data rate frequency is greater than the data sampling rate frequency. Initially, the DCO frequency is incremented in large steps to aid fast acquisition. As the DCO frequency approaches the data frequency, the step size is reduced until the DCO frequency is within 250 ppm of the data frequency, at which point LOL is deasserted.

When LOL is deasserted, the frequency-locked loop is turned off. The PLL or DLL pulls in the DCO frequency until the DCO frequency equals the data frequency.

### EDGE SELECT

A binary, or Alexander, phase detector drives both the DLL and PLL at all division rates. Duty cycle distortion on the received data leads to a dead band in the phase detector transfer function if phase errors are measured on both rising and falling data transitions. This dead band leads to jitter generation of unknown spectral composition with potentially large peak-to-peak amplitude.

The recommended usage of the device when the dc offset loop is disabled is to compute phase errors exclusively on either the rising data edges with  $\text{EDGE\_SEL}[1:0]$  (Bits[D4:D3] in Register 0x10) = 1 (decimal) or on the falling data edges with  $\text{EDGE\_SEL}[1:0] = 2$ . The alignment of the clock to the rising data edges with  $\text{EDGE\_SEL}[1:0] = 1$  is represented by the top two curves in Figure 16. Duty cycle distortion with narrow 1s moves the significant sampling instance where data is sampled to the right of center. The alignment of the clock to the falling data edges with  $\text{EDGE\_SEL}[1:0] = 2$  is represented by the first and third curves in Figure 16. The significant sampling instance moves to the left of center. Sample phase adjustment for rates above 5.65 Gbps can be used to move the significant sampling instance to the center of the narrow 1 (or narrow 0) for best jitter tolerance.

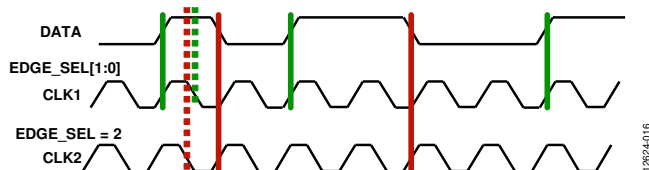

Figure 16. Phase Detector Timing

### DLL Slew

Jitter tolerance beyond the transfer bandwidth of the CDR is determined by the slew rate of the delay-locked loop implementing a delta modulator on phase. Setting  $\text{DLL\_SLEW}[1:0] = 2$ , (the default value) in the Register 0x13 configures the DLL to track 0.75 UI p-p jitter at the highest frequency breakpoint at 4 MHz for CPRI = 9.8304 Gbps.  $\text{DPLLD}[1:0]$  can be set to 0, giving lower jitter generation on the recovered clock and better high frequency jitter tolerance.

### Sample Phase Adjustment

The phase of the sampling instant can be adjusted using the I<sup>2</sup>C interface when the device operates at data rates of 5.65 Gbps or higher by writing to  $\text{SAMPLE\_PHASE}[3:0]$  (Bits[D3:D0] in Register 0x14). This feature allows the user to adjust the sampling instant to improve the BER and jitter tolerance. Although the default sampling instant chosen by the CDR is sufficient in most applications, when dealing with some degraded input signals, the BER and jitter tolerance performance can be improved by manually adjusting the phase.

A total adjustment range of 0.5 UI is available, with 0.25 UI in each direction, in increments of 1/32 UI.  $\text{SAMPLE\_PHASE}[3:0]$  is a twos complement number. The relationship between data and the sampling clock is shown in Figure 17.

### Transfer Bandwidth

The transfer bandwidth can be adjusted using the I<sup>2</sup>C interface by writing to the  $\text{TRANBW}[2:0]$  bits in Register 0x10. The default value is 4. When set to values below 4, the transfer bandwidth is reduced. When set to values above 4, the transfer bandwidth is increased. The resulting transfer bandwidth (BW) is based on the following formula:

$$\text{Transfer BW} = \text{Default Transfer BW} \times \left( \frac{\text{TRANBW}[2:0]}{4} \right)$$

For example, at  $\text{CPRI} \times 16$  (9.8304 Gbps), the default transfer bandwidth is approximately 2 MHz. The resulting transfer bandwidth when  $\text{TRANBW}[2:0]$  is changed is

- $\text{TRANBW}[2:0] = 1$ : transfer BW = 500 kHz
- $\text{TRANBW}[2:0] = 2$ : transfer BW = 1.0 MHz
- $\text{TRANBW}[2:0] = 3$ : transfer BW = 1.5 MHz
- $\text{TRANBW}[2:0] = 4$ : transfer BW = 2.0 MHz (default)
- $\text{TRANBW}[2:0] = 5$ : transfer BW = 2.5 MHz
- $\text{TRANBW}[2:0] = 6$ : transfer BW = 3.0 MHz
- $\text{TRANBW}[2:0] = 7$ : transfer BW = 3.5 MHz

Reducing the transfer bandwidth is commonly used in optical transport network (OTN) applications. Never set  $\text{TRANBW}[2:0]$  to 0, because this makes the CDR open loop. Also note that setting  $\text{TRANBW}[2:0]$  above 4 can cause a slight increase in jitter generation and potential jitter peaking.

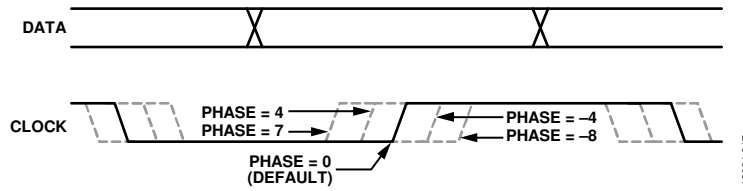

Figure 17. Data vs. Sampling Clock

## PASSIVE EQUALIZER

A passive equalizer is available at the input to equalize large signals that have undergone distortion due to PCB traces, vias, or connectors. The adaptive EQ functions only at data rates greater than 5.5 Gbps. Therefore, at rates less than 5.5 Gbps, the EQ must be manually set.

The equalizer can be manually set using the LA\_EQ register (Register 0x16). An adaptive loop is also available to optimize the EQ setting based on characteristics of the received eye at the phase detector. If the channel is known in advance, set the EQ manually to obtain the best performance; however, the adaptive EQ finds the best setting in most cases.

Table 19 lists the typical EQ settings for several trace lengths. The values in Table 19 are based on measurements taken on a test board with simple FR-4 traces. Table 20 lists the typical maximum reach in inches of FR-4 of the EQ at several data rates. If a real channel includes lossy connectors or vias, the FR-4 reach length is lower. For any real-world system, it is highly recommended to test several EQ settings with the real channel to ensure the best signal integrity.

**Table 19. EQ Settings vs. Trace Length on FR-4**

| Trace Length (Inches) | Typical EQ Setting |
|-----------------------|--------------------|
| 6                     | 10                 |
| 10                    | 12                 |
| 15                    | 14                 |
| 20 to 30              | 15                 |

**Table 20. Typical EQ Reach on FR-4 vs. Maximum Data Rates Supported**

| Maximum Data Rate (Gbps) | Typical EQ Reach on FR-4 (Inches) |
|--------------------------|-----------------------------------|
| 4                        | 30                                |
| 8                        | 20                                |
| 10                       | 15                                |
| 11                       | 10                                |

## 0 dB EQ

The 0 dB EQ path connects the input signal directly to the digital logic inside the ADN2905. The 0 dB EQ is useful at lower data rates where the signal is large (therefore, the limiting amplifier is not needed, and power can be saved by deselecting the limiting amplifier) and unimpaired (therefore, the equalizer is not needed). The signal swing of the internal digital circuit is 600 mV p-p differential, the minimum signal amplitude that must be provided in 0 dB EQ mode.

In 0 dB EQ mode, the internal 50  $\Omega$  termination resistors can be configured in one of two ways, either floated or tied to VCC = 1.2 V (see Figure 22 and Table 23). By setting the RX\_TERM\_FLOAT bit (Bit D7 in Register 0x16) to 1, these 50  $\Omega$  termination resistors are floated internal to the ADN2905 (see Figure 25). By setting the RX\_TERM\_FLOAT bit to 0, these 50  $\Omega$  termination resistors are connected to VCC = 1.2 V (see Figure 26). In both termination cases, the user must ensure a valid common-mode voltage on the input.

When the termination is floated, the two 50  $\Omega$  resistors are a purely differential termination. The input must conform to the range of signals shown in Figure 28.

When the termination is connected to a 1.2 V VCC power supply (see Figure 26 and Figure 27), the common-mode voltage is created by the driver circuit and the 50  $\Omega$  resistors on the ADN2905. For example, the driver can be an open-drain switched current (see Figure 26), and the 50  $\Omega$  resistors return this current to VCC. In Figure 26, the common-mode voltage is created by both the current and the resistors. In this case, ensure that the current is a minimum of 6 mA, which gives a single-ended swing of 300 mV or a differential swing of 600 mV p-p differential, with  $V_{CM} = 1.05$  V (see Figure 28). The maximum current is 10 mA, which gives a single-ended 500 mV swing and a differential 1.0 V p-p swing with  $V_{CM} = 0.95$  V (see Figure 29).

Another possibility is to back terminate the switched current driver, as shown in Figure 27, with the two VCC supplies having the same potential. In this example, the current is returned to VCC by the two 50  $\Omega$  resistors in parallel, or 25  $\Omega$ , so that the minimum current is 12 mA and the maximum current is 20 mA.

## LOCK DETECTOR OPERATION

The lock detector on the ADN2905 has three modes of operation: normal mode, LTR mode, and static LOL mode.

### Normal Mode

In normal mode, the ADN2905 is a multiple rate data recovery device that locks onto the CPRI data rate from 614.4 Mbps to 9.8304 Gbps without the use of a reference clock as an acquisition aid. In this mode, the lock detector monitors the frequency difference between the DCO and the input data frequency, and deasserts the loss of lock signal, which appears on LOL (Pin 6) when the DCO is within 250 ppm of the data frequency. This enables the digital PLL (DPLL), which pulls the DCO frequency in the remaining amount and acquires phase lock. When locked, if the input frequency error exceeds 1000 ppm (0.1%), the loss of lock signal is reasserted and control returns to the frequency loop, which begins a new frequency acquisition. The LOL pin remains asserted until the DCO locks onto a valid input data stream to within 250 ppm frequency error. This hysteresis is shown in Figure 18.

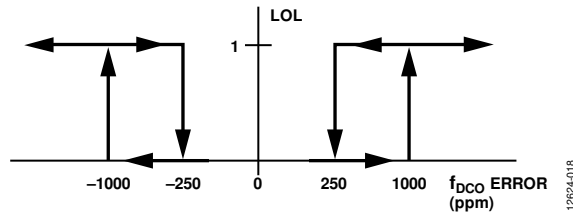

Figure 18. Transfer Function of LOL

### LOL Detector Operation Using a Reference Clock (LTR Mode)

In lock to reference (LTR) mode, a reference clock is used as an acquisition aid to lock the ADN2905 DCO. LTR mode is enabled by setting the CDR\_MODE[2:0] bits to 2 (Bits[D6:D4] in Register 0x8). The user must also write to the FREF\_RANGE[1:0] bits and the DATA\_TO\_REF\_RATIO[3:0] bits (Bits[D5:D4] and Bits[D3:D0] in Register 0xF) to set the reference frequency range and the divide ratio of the data rate with respect to the reference frequency. Finally, the reference clock power down to the reference clock buffer must be deasserted by writing a 0 to the REFCLK\_PDN bit (Bit D2 in Register 0xA). To maintain fastest acquisition, keep Bit D0 in Register 0xA set to 1.

For more details, see the Reference Clock (Optional) section. In LTR mode, the lock detector monitors the difference in frequency between the divided down DCO and the divided down reference clock. The loss of lock signal, which appears on LOL (Pin 6), is deasserted when the DCO is within 250 ppm of the desired frequency. This enables the DPLL, which pulls in the DCO frequency by the remaining amount with respect to the input data and acquires phase lock. When locked, if the frequency error exceeds 1000 ppm (0.1%), the loss of lock signal is reasserted and control returns to the frequency loop, which reacquires lock with respect to the reference clock. The LOL pin remains asserted until the DCO frequency is within 250 ppm of the desired frequency. This hysteresis is shown in Figure 18.

### Static LOL Mode

The ADN2905 implements a static LOL feature that indicates whether a loss of lock condition has ever occurred and remains

asserted, even if the ADN2905 regains lock, until the static LOL bit (Bit D2 in Register 0x6) is manually reset. If a loss of lock condition occurs, this bit is internally asserted to logic high. The static LOL bit remains high even after the ADN2905 reacquires lock to a new data rate. This bit can be reset by writing a 1, followed by 0, to the reset static LOL bit (Bit D2 in Register 0x8). When reset, the static LOL bit remains deasserted until another loss of lock condition occurs.

Writing a 1 to the LOL configuration bit (Bit D4 in Register 0x9) causes the LOL pin (Pin 6) to become a static LOL indicator. In this mode, the LOL pin mirrors the contents of the static LOL bit (Bit D2 in Register 0x6) and has the functionality described previously. The LOL configuration bit defaults to 0. In this mode, the LOL pin operates in the normal operating mode; that is, it is asserted only when the ADN2905 is in acquisition mode and deasserts when the ADN2905 has reacquired lock.

### HARMONIC DETECTOR

The ADN2905 provides a harmonic detector that detects whether the input data has changed to a lower harmonic of the data rate than the one that the sampling clock is currently locked onto. For example, if the input data instantaneously changes from a CPRI × 16 (9.8304 Gbps) to a CPRI × 4 (2.4576 Gbps) bit stream, this can be perceived as a valid CPRI × 16 bit stream because the CPRI × 4 data pattern is exactly 4× slower than the CPRI × 16 pattern. Therefore, if the change in data rate is instantaneous, a 101 pattern at CPRI × 4 (2.4576 Gbps) is perceived by the ADN2905 as a 111100001111 pattern at CPRI × 16 (9.8304 Gbps). If the change to a lower harmonic is instantaneous, a typical inferior CDR may remain locked at the higher data rate.

The ADN2905 implements a harmonic detector that automatically identifies whether the input data has switched to a lower harmonic of the data rate than the one that the DCO is currently locked onto. When a harmonic is identified, the LOL pin is asserted, and a new frequency acquisition is initiated. The ADN2905 automatically locks onto the new data rate, and the LOL pin is deasserted.

The time to detect a lock to harmonic is

$$2^{16} \times (T_D/\rho)$$

where:

$1/T_D$  is the new data rate. For example, if the data rate is switched from CPRI × 16 (9.8304 Gbps) to CPRI × 4 (2.4576 Gbps),  $T_D = 1/2.4576$  GHz.

$\rho$  is the data transition density. Most coding schemes seek to ensure that  $\rho = 0.5$ , for example, PRBS and 8B/10B.

When the ADN2905 is placed in lock to reference mode, the harmonic detector is disabled.

### OUTPUT DISABLE AND SQUELCH

The ADN2905 offers output disable/squelch. The DATOUTP/DATOUTN outputs can be disabled by setting the DATOUT\_DISABLE bit (Bit D4 in Register 0x1E) high. When an output is

disabled, it is fully powered down, saving approximately 30 mW total power.

To set the data output while leaving the clock on, the output data can be squelched by setting the data squelch bit (Bit D5 in Register 0x1E) high. In this mode, the data driver remains powered, but the data itself is forced to be a value of 0 or 1, depending on the setting of the DATA\_POLARITY bit (Bit D1 in Register 0x1E).

## I<sup>2</sup>C INTERFACE

The ADN2905 supports a 2-wire, I<sup>2</sup>C-compatible, serial bus driving multiple peripherals. Two inputs, serial data (SDA) and serial clock (SCK), carry information between any devices connected to the bus. Each slave device is recognized by a unique address. The slave address consists of the seven MSBs of an 8-bit word. The upper six bits (Bits[6:1]) of the 7-bit slave address are factory programmed to 100000. The LSB of the slave address (Bit 0) is set by Pin 22, I<sup>2</sup>C\_ADDR. The LSB of the word specifies either a read or write operation (see Figure 10). Logic 1 corresponds to a read operation, whereas Logic 0 corresponds to a write operation.

To control the device on the bus, the following protocol must be used:

1. The master initiates a data transfer by establishing a start condition, defined as a high to low transition on SDA while SCK remains high. This indicates that an address/data stream follows.
2. All peripherals respond to the start condition and shift the next eight bits (the 7-bit address and the R/W bit). The bits are transferred from MSB to LSB.
3. The peripheral that recognizes the transmitted address responds by pulling the data line low during the ninth clock pulse. This is an acknowledge bit.
4. All other devices withdraw from the bus at this point and maintain an idle condition. In the idle condition, the device monitors the SDA and SCK lines waiting for the start condition and the correct transmitted address.

The R/W bit determines the direction of the data. Logic 0 on the LSB of the first byte means that the master writes information to the peripheral. Logic 1 on the LSB of the first byte means that the master reads information from the peripheral.

The ADN2905 acts as a standard slave device on the bus. The data on the SDA pin is eight bits long, supporting the 7-bit addresses plus the R/W bit. The ADN2905 has subaddresses to enable the user-accessible internal registers (see Table 7).

The ADN2905, therefore, interprets the first byte as the device address and the second byte as the starting subaddress. Auto-increment mode is supported, allowing data to be read from or written to the starting subaddress and each subsequent address without manually addressing the subsequent subaddress. A data transfer is always terminated by a stop condition. The user can also access any unique subaddress register on a one-by-one basis without updating all registers.

Stop and start conditions can be detected at any stage of the data transfer. If these conditions are asserted out of sequence with normal read and write operations, they cause an immediate jump to the idle condition. During a given SCK high period, issue one start condition, one stop condition, or a single stop condition followed by a single start condition. If the user issues an invalid subaddress, the ADN2905 does not issue an acknowledge and returns to the idle condition. If the user exceeds the highest subaddress while reading back in auto-increment mode, the highest subaddress register contents continue to be output until the master device issues a no acknowledge. This indicates the end of a read. In a no acknowledge condition, the SDA line is not pulled low on the ninth pulse. See Figure 11 and Figure 12 for sample read and write data transfers, respectively, and Figure 13 for a more detailed timing diagram.

## REFERENCE CLOCK (OPTIONAL)

A reference clock is not required to perform data recovery with the ADN2905. However, support for an optional reference clock is provided. The reference clock can be driven differentially or single-ended. If the reference clock is not used, float both the REFCLKP and REFCLKN pins.

Two 50  $\Omega$  series resistors present a differential load between REFCLKP and REFCLKN. Common mode is internally set to  $0.56 \times VCC$  by a resistor divider between VCC and VEE. See Figure 19, Figure 20, and Figure 21 for sample configurations.

The reference clock input buffer accepts any differential signal with a peak-to-peak differential amplitude of greater than 100 mV. The phase noise and duty cycle of the reference clock are not critical, and a 100 ppm accuracy is sufficient.

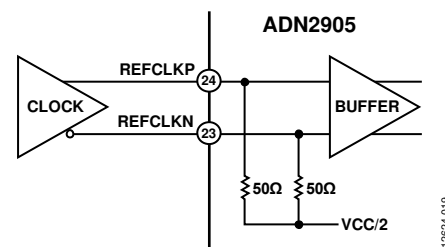

Figure 19. DC-Coupled, Differential REFCLKx Configuration

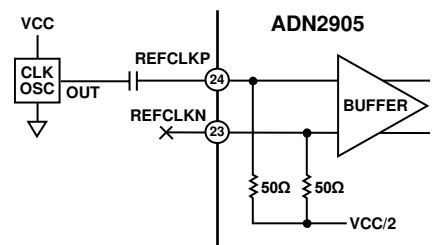

Figure 20. AC-Coupled, Single-Ended REFCLKx Configuration

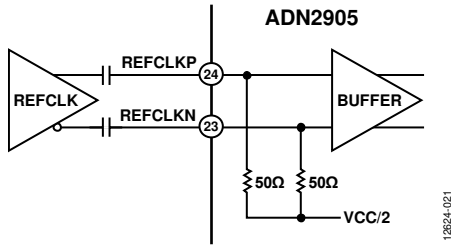

Figure 21. AC-Coupled, Differential REFCLKx Configuration

The reference clock can be used either as an acquisition aid for the ADN2905 to lock onto data, or to measure the frequency of the incoming data to within 0.01%. The modes are mutually exclusive because, in the first use, the user can force the device to lock onto only a known data rate; in the second use, the user can measure an unknown data rate.

Lock to reference mode is enabled by writing a 2 to the CDR\_MODE[2:0] bits (Bits[D6:D4] in Register 0x8). An on-chip clock buffer must be powered on by writing a 0 to the REFCLK\_PDN bit (Bit D2 in Register 0xA). Fine data rate readback mode is enabled by writing a 1 to the RATE\_MEAS\_EN bit (Bit D1 in Register 0x8). Enabling lock to reference and data rate readback at the same time causes an indeterminate state and is not supported.

**Using the Reference Clock to Lock onto Data**

In LTR mode, the ADN2905 locks onto a frequency derived from the reference clock according to the following equation:

$$Data\ Rate/2^{(LTR\_MODE[3:0] - 1)} = REFCLK/2^{LTR\_MODE[5:4]}$$

The user must know exactly what the data rate is and provide a reference clock that is a function of this rate. The ADN2905 can still be used as a continuous rate device in this configuration if the user can provide a reference clock that has a variable frequency (see the AN-632 Application Note).

The reference clock can have a frequency from 11.05 MHz to 176.8 MHz. By default, the ADN2905 expects a reference clock of between 11.05 MHz and 22.1 MHz. If the reference clock is between 22.1 MHz and 44.2 MHz, 44.2 MHz and 88.4 MHz, or 88.4 MHz and 176.8 MHz, the user must configure the ADN2905 to use the correct reference frequency range by setting the two bits of FREF\_RANGE[1:0] (Bits[D5:D4] in Register 0xF).

Table 21. LTR\_MODE Register Settings

| FREF_RANGE[1:0] | Range (MHz)   | DATA_TO_REF_RATIO[3:0] | Ratio            |
|-----------------|---------------|------------------------|------------------|
| 00              | 11.05 to 22.1 | 0000                   | 2 <sup>-1</sup>  |
| 01              | 22.1 to 44.2  | 0001                   | 2 <sup>0</sup>   |
| 10              | 44.2 to 88.4  | n                      | 2 <sup>n-1</sup> |
| 11              | 88.4 to 176.8 | 1010                   | 2 <sup>9</sup>   |

The user can specify a fixed integer multiple of the reference clock to lock onto using the DATA\_TO\_REF\_RATIO[3:0] bits (Bits[D3:D0] in Register 0xF), as follows:

$$DATA\_TO\_REF\_RATIO[3:0] = Data\ Rate \div DIV\_f_{REF}$$

where DIV\_f\_REF represents the divided-down reference referred to the 11.05 MHz to 22.1 MHz band.

For example, if the reference clock frequency is 38.88 MHz and the input data rate is 622.08 Mbps, the FREF\_RANGE[1:0] bits are set to 01 to give a divided-down reference clock of 19.44 MHz. DATA\_TO\_REF\_RATIO[3:0] is set to 0110, that is, 6, because

$$622.08\ Mbps/19.44\ MHz = 2^{(6-1)}$$

If the ADN2905 is operating in lock to reference mode, and the user changes the reference frequency, the f\_REF range or the f\_REF ratio (Bits[D5:D4] or Bits[D3:D0], respectively, in Register 0xF), this change must be followed by writing a low to high to low transition to the INIT\_FREQ\_ACQ bit (Bit D6 in Register 0x9) to initiate a new lock to reference command.

By default in lock to reference clock mode, when lock has been achieved and the ADN2905 is in tracking mode, the frequency of the DCO is compared to the frequency of the reference clock. If this frequency error exceeds 1000 ppm, lock is lost, LOL is asserted, and the device relocks to the reference clock while continuing to output a stable clock.

An alternative configuration is enabled by setting LOL data (Bit D6 in Register 0xF) to 1. In this configuration, when the device is in tracking mode, the frequency of the DCO is compared to the frequency of the input data rather than the frequency of the reference clock. If this frequency error exceeds 1000 ppm, lock is lost, LOL is asserted, and the device relocks to the reference clock while continuing to output a stable clock.

**Using the Reference Clock to Measure Data Frequency**

The user can also provide a reference clock to measure the recovered data frequency. In this case, the user provides a reference clock, and the ADN2905 compares the frequency of the incoming data to the incoming reference clock and returns a ratio of the two frequencies to 0.01% (100 ppm). The accuracy error of the reference clock is added to the accuracy error of the ADN2905 data rate measurement. For example, if a 100 ppm accuracy reference clock is used, the total accuracy of the measurement is 200 ppm.

The reference clock can range from 11.05 MHz and 176.8 MHz. Prior to reading back the data rate using the reference clock, the FREF\_RANGE[1:0] bits (Bits[D5:D4] in Register 0xF) must be set to the appropriate frequency range with respect to the reference clock being used according to Table 21.

A fine data rate readback is then executed as follows:

1. Apply the reference clock.
2. Write a 0 to the REFCLK\_PDN bit (Bit D2 in Register 0xA) to enable the reference clock circuit.
3. Write to the FREF\_RANGE[1:0] bits (Bits[D5:D4] in Register 0xF) to select the appropriate reference clock frequency circuit.
4. Write a 1 to the RATE\_MEAS\_EN bit (Bit D1 in Register 0x8) to enable the fine data rate measurement capability of the ADN2905. This bit is level sensitive and does not need to be reset to perform subsequent frequency measurements.
5. Write a low to high to low transition to the RATE\_MEAS\_RESET bit (Bit D0 in Register 0x8) to initiate a new data rate measurement.
6. Read back the RATE\_MEAS\_COMP bit (Bit D0 in Register 0x6). If the bit is 0, the measurement is not complete. If it is 1, the measurement is complete and the data rate can be read back on the RATE\_FREQ[23:0] and FREQ\_RB2[6:2] bits (see Table 7). The approximate time for a data rate measurement is given in Equation 2.

Use the following equation to determine the data rate:

$$f_{\text{DATARATE}} = \frac{(\text{RATE\_FREQ}[23:0] \times f_{\text{REFCLK}})}{2^{\text{LTR}[5:4]} \times 2^7 \times 2^{\text{FULLRATE}} \times 2^{\text{DIVRATE}}} \quad (1)$$

where:

- $f_{\text{DATARATE}}$  is the data rate in Mbps.
- $\text{RATE\_FREQ}[23:0]$  is from FREQ2[7:0] (most significant byte), FREQ1[7:0], and FREQ0[7:0] (least significant byte). See Table 7.
- $f_{\text{REFCLK}}$  is the reference clock frequency in MHz.
- $\text{LTR}[5:4] = \text{LTR\_MODE}[5:4]$ .
- $\text{FULLRATE} = \text{FREQ\_RB2}[6]$  (Bit D6 in Register 0x5).
- $\text{DIVRATE} = \text{FREQ\_RB2}[5:2]$  (Bits[D5:D2] in Register 0x5).

| MSB        |            | LSB        |
|------------|------------|------------|
| D23 to D16 | D15 to D8  | D7 to D0   |
| FREQ2[7:0] | FREQ1[7:0] | FREQ0[7:0] |

Consider the example of a 1.25 Gbps (GE) input signal and a reference clock source of 32 MHz at the PIN/NIN and REFCLKP/REFCLKN ports, respectively. In this case, the FREF\_RANGE[1:0] bits (Bits[D5:D4] in Register 0xF) are 01, and the reference frequency falls into the range of 22.1 MHz to 44.2 MHz. After following Step 1 through Step 6, the readback value of the RATE\_FREQ[23:0] bits is 0x13880, which is equal to  $8 \times 10^4$ . The readback value of the FULLRATE bit (Bit D6 in Register 0x5) is 1, and the readback value of the DIVRATE[3:0] bits (Bits[D5:D2] in Register 0x5) is 2. Inserting these values into Equation 1 yields

$$((8 \times 10^4) \times (32 \times 10^6)) / (2^1 \times 2^7 \times 2^1 \times 2^2) = 1.25 \text{ Gbps}$$

If subsequent frequency measurements are required, keep the RATE\_MEAS\_EN bit (Bit D1 in Register 0x8) set to 1. It does not need to be reset. The measurement process is reset by writing

a 1 followed by a 0 to the RATE\_MEAS\_RESET bit (Bit D0 in Register 0x8). This initiates a new data rate measurement. Follow Step 2 through Step 6 to read back the new data rate. Note that a data rate readback is valid only if the LOL pin is low. If LOL is high, the data rate readback is invalid.

Initiating a frequency measurement by writing a low to high to low transition to the RATE\_MEAS\_RESET bit (Bit D0 in Register 0x8) also resets the RATE\_MEAS\_COMP bit (Bit D10 in Register 0x6). The approximate time to complete a frequency measurement from the RATE\_MEAS\_RESET bit being written with a low to high to low transition to when the RATE\_MEAS\_COMP bit returns high is given by

$$\text{Measurement Time} = \frac{2^{11} \times 2^{\text{LTR}[5:4]}}{f_{\text{REFCLK}}} \quad (2)$$

### ADDITIONAL FEATURES AVAILABLE VIA THE I<sup>2</sup>C INTERFACE

#### Coarse Data Rate Readback

The data rate can be read back over the I<sup>2</sup>C interface to approximately  $\pm 5\%$  without using an external reference clock according to the following formula:

$$\text{Data Rate} = \frac{f_{\text{DCO}}}{2^{\text{FULLRATE}} \times 2^{\text{DIVRATE}}} \quad (3)$$

where

- $f_{\text{DCO}}$  is the frequency of the DCO, derived as shown in Table 22.
- $\text{FULLRATE} = \text{FREQ\_RB2}[6]$  (Bit D6 in Register 0x5).
- $\text{DIVRATE} = \text{FREQ\_RB2}[5:2]$  (Bits[D5:D2] in Register 0x5).

Four oscillator cores, defined by the VCOSEL[9:8] bits (Bits[D1:D0] in Register 0x5), span the highest octave of data rates according to Table 22.

Table 22. DCO Center Frequency vs. VCOSEL[9:8]

| Core = (VCOSEL[9:8]) | Minimum Frequency (MHz) = MIN_F (Core) | Maximum Frequency (MHz) = MAX_F (Core) |
|----------------------|--|--|
| 0                    | 5570                                   | 7105                                   |
| 1                    | 7000                                   | 8685                                   |
| 2                    | 8610                                   | 10,330                                 |
| 3                    | 10,265                                 | 11,625                                 |

Determine  $f_{\text{DCO}}$  from the VCOSEL[9:0] bits (Bits[D7:D0] in Register 0x4, and Bits[D1:D0] in Register 0x5), using the following formula:

$$f_{\text{DCO}} = \text{MIN\_F}(\text{core}) + \frac{\text{MAX\_F}(\text{core}) - \text{MIN\_F}(\text{core})}{256} \times \text{VCOSEL}[9:0] \quad (4)$$



**Worked Example**

Read back the contents of the `FREQ_RB1` and `FREQ_RB2` registers. For example, with a  $\text{CPRI} \times 16$  (9.8304 Gbps) signal presented to the PIN/NIN ports

```
FREQ_RB1 = 0xBA
FREQ_RB2 = 0x02
FULLRATE (FREQ_RB2[6]) = 0
DIVRATE (FREQ_RB2[5:2]) = 0
Core (FREQ_RB2[1:0]) = 2
```

Then

$f_{DCO} =$

$$8610 \text{ Mbps} + \frac{10,300 \text{ Mbps} - 8610 \text{ Mbps}}{256} \times 186 = 9837.89 \text{ Mbps}$$

and

$$f_{data} = \frac{9837.89 \text{ Mbps}}{2^0 \times 2^0} = 9.83789 \text{ Gbps}$$

**Initiate Frequency Acquisition**

A frequency acquisition can be initiated by writing a 1 followed by a 0 to the `INIT_FREQ_ACQ` bit (Bit D6 in Register 0x9). This initiates a new frequency acquisition while keeping the [ADN2905](#) in the operating mode that was previously programmed in the `CTRLA`, `CTRLB`, and `CTRLC` registers.

**PRBS Generator/Receiver**

The [ADN2905](#) has an integrated PRBS generator and detector for system testing purposes. The devices are configurable as either a PRBS detector or a PRBS generator.

The following steps configure the PRBS detector:

1. Set the `DATA_RECEIVER_ENABLE` bit (Bit D2 in Register 0x3F) to 1 while also setting the `DATA_RECEIVER_MODE[1:0]` bits (Bits[D1:D0] in Register 0x3F) according to the desired PRBS pattern (0 = PRBS7; 1 = PRBS15; 2 = PRBS31). Setting the `DATA_RECEIVER_MODE[1:0]` bits to 3 leads to a one shot sampling of recovered data into the `DATA_LOADED[15:0]` bits.
2. Set the `DATA_RECEIVER_CLEAR` bit (Bit D3 in Register 0x3F) to 1 followed by 0 to clear the `PRBS_ERROR` and `PRBS_ERROR_COUNT` bits.
3. The states of the `PRBS_ERROR` bit (Bit D0 in Register 0x41) and the `PRBS_ERROR_COUNT[7:0]` bits (Bits[D7:D0] in Register 0x40) can be frozen by setting the `DATA_RECEIVER_ENABLE` bits (Bit D2 in Register 0x3F) to 0.

The following steps configure the PRBS generator:

1. Set the `DATA_GEN_EN` bit (Bit D2 in Register 0x39) to 1 to enable the PRBS generator and set the `DATA_GEN_MODE[1:0]` bits (Bits[D1:D0] in Register 0x39) for the desired PRBS output pattern (0 = PRBS7; 1 = PRBS15; 2 = PRBS31). An arbitrary 32-bit pattern stored as `PROG_DATA[31:0]` is activated by setting the `DATA_GEN_MODE[1:0]` bits to 3.

2. Strings of consecutive identical digits (CIDs) sensed from the `DATA_CID_BIT` bit (Bit D5 in Register 0x39) can be introduced in the generator by setting the `DATA_CID_EN` bit (Bit D4 in Register 0x39) to 1. The length of CIDs is  $8 \times \text{DATA\_CID\_LENGTH}$ , which is set via Bits[D7:D0] in Register 0x3A.

**Table 23. PRBS Settings**

| PRBS Pattern    | DATA_GEN_MODE[1:0] | PRBS Polynomial       |
|-----------------|--------------------|-----------------------|
| PRBS7           | 0x00               | $1 + x^6 + x^7$       |
| PRBS15          | 0x01               | $1 + x^{14} + x^{15}$ |
| PRBS31          | 0x10               | $1 + x^{28} + x^{31}$ |
| PROG_DATA[31:0] | 0x11               | N/A                   |

**Double Data Rate Mode**

The default output clock mode is a double data rate (DDR) clock, where the output clock frequency is  $\frac{1}{2}$  the data rate. DDR mode allows direct interfacing to FPGAs that support clocking on both rising and falling edges. Setting the `DDR_DISABLE` bit (Bit D2 in Register 0x1E) to 1 enables full data rate mode. Full data rate mode is not supported for data rates in the highest octave between 5.6 Gbps and 9.8304 Gbps.

**CDR Bypass Mode**

The CDR in the [ADN2905](#) can be bypassed by setting the CDR bypass bit (Bit D5 in Register 0x9) to 1. In this mode, the [ADN2905](#) feeds the input directly through the input amplifiers to the output buffer, bypassing the CDR. The CDR bypass path is intended for use in testing or debugging a system. Use the CDR bypass path at data rates at or below 3.0 Gbps only.

**Transmission Lines**

Use of 50  $\Omega$  transmission lines is required for all high frequency input and output signals to minimize reflections: PIN, NIN, DATOUTP, and DATOUTN (also REFCLKP and REFCLKN, if using a high frequency reference clock, such as 155 MHz). It is also necessary for the PIN and NIN input traces to be matched in length, and the DATOUTP and DATOUTN output traces to be matched in length to avoid skew between the differential traces.

The high speed inputs (PIN and NIN) are each internally terminated with 50  $\Omega$  to an internal reference voltage (see Figure 26). As with any high speed, mixed-signal circuit, take care to keep all high speed digital traces away from sensitive analog nodes.

The high speed outputs (DATOUTP, DATOUTN) are internally terminated with 50  $\Omega$  to VCC.

**Soldering Guidelines for Lead Frame Chip Scale Package**

The lands on the 24-lead LFCSP are rectangular. The printed circuit board pad for these is 0.1 mm longer than the package land length, and 0.05 mm wider than the package land width. Center the land on the pad to ensure that the solder joint size is maximized. The bottom of the lead frame chip scale package has a central exposed pad. The pad on the printed circuit board must be at least as large as this exposed pad. Connect the exposed pad to VEE using plugged vias to prevent solder from leaking

through the vias during reflow. This ensures a solid connection from the exposed pad to VEE.

It is highly recommended to include as many vias as possible when connecting the exposed pad to VEE. This minimizes the thermal resistance between the die and VEE, and minimizes the die temperature. It is recommended that the vias be connected to a VEE plane, or planes, rather than a signal trace to improve heat dissipation, as shown in Figure 23.

Placing an external VEE plane on the backside of the board opposite the ADN2905 provides an additional benefit because this allows easier heat dissipation into the ambient environment.

**INPUT CONFIGURATIONS**

The ADN2905 input stage can work with the signal source in an ac-coupled or dc-coupled configuration. To best fit in a required applications environment, the ADN2905 supports one of following input modes: equalizer, or bypass. The ADN2905

can be configured to use any required input configuration through the I<sup>2</sup>C bus. Figure 22 shows a block diagram of the input stage circuit.

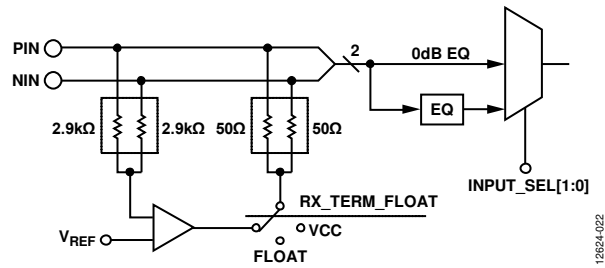

Figure 22. Input Stage Block Diagram

The input signal path is configurable with the INPUT\_SEL[1:0] bits (Bits[D6:D5] in Register 0x16). Table 24 shows the INPUT\_SEL[1:0] bits and the input signal configuration.

Table 24. Input Signal Configuration

| Selected Input     | INPUT_SEL[1:0] | RX_TERM_FLOAT = 0 | RX_TERM_FLOAT = 1 | ADN2905 Availability |
|--------------------|----------------|-------------------|-------------------|----------------------|
| Limiting Amplifier | 00             | V <sub>REF</sub>  | Not defined       | Not defined          |
| Equalizer          | 01             | V <sub>REF</sub>  | Not defined       | Yes                  |
| 0 dB EQ            | 10             | VCC               | Float             | Yes                  |
| Not Defined        | 11             | Not defined       | Not defined       | Not defined          |

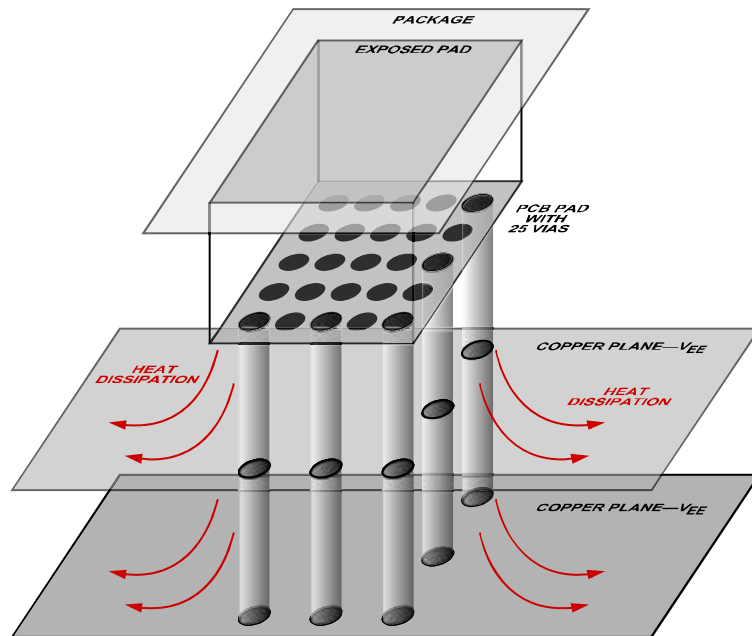

Figure 23. Connecting Vias to VEE