



Chipsmall Limited consists of a professional team with an average of over 10 year of expertise in the distribution of electronic components. Based in Hongkong, we have already established firm and mutual-benefit business relationships with customers from,Europe,America and south Asia,supplying obsolete and hard-to-find components to meet their specific needs.

With the principle of "Quality Parts,Customers Priority,Honest Operation,and Considerate Service",our business mainly focus on the distribution of electronic components. Line cards we deal with include Microchip,ALPS,ROHM,Xilinx,Pulse,ON,Everlight and Freescale. Main products comprise IC,Modules,Potentiometer,IC Socket,Relay,Connector.Our parts cover such applications as commercial,industrial, and automotives areas.

We are looking forward to setting up business relationship with you and hope to provide you with the best service and solution. Let us make a better world for our industry!



Contact us

Tel: +86-755-8981 8866 Fax: +86-755-8427 6832

Email & Skype: info@chipsmall.com Web: www.chipsmall.com

Address: A1208, Overseas Decoration Building, #122 Zhenhua RD., Futian, Shenzhen, China



FEATURES**Input voltage range: 1.6 V to 3.6 V****Output current range: 500 μ A to 1.2 A****Output voltage accuracy: $\pm 2\%$** **Operating temperature range: -40°C to $+125^{\circ}\text{C}$** **GENERAL DESCRIPTION**

The ADP1754/ADP1755 evaluation board is used to demonstrate the functionality of the ADP1754/ADP1755 series of linear regulators.

Simple device measurements, such as line and load regulation, dropout, and ground current, can be demonstrated with just a single voltage supply, a voltmeter, a current meter, and load resistors.

For more details about the ADP1754/ADP1755 linear regulators, visit www.analog.com.

EVALUATION BOARD DIGITAL PICTURE

Figure 1.

Rev. 0

Evaluation boards are only intended for device evaluation and not for production purposes. Evaluation boards are supplied "as is" and without warranties of any kind, express, implied, or statutory including, but not limited to, any implied warranty of merchantability or fitness for a particular purpose. No license is granted by implication or otherwise under any patents or other intellectual property by application or use of evaluation boards. Information furnished by Analog Devices is believed to be accurate and reliable. However, no responsibility is assumed by Analog Devices for its use, nor for any infringements of patents or other rights of third parties that may result from its use. Analog Devices reserves the right to change devices or specifications at any time without notice. Trademarks and registered trademarks are the property of their respective owners. Evaluation boards are not authorized to be used in life support devices or systems.

TABLE OF CONTENTS

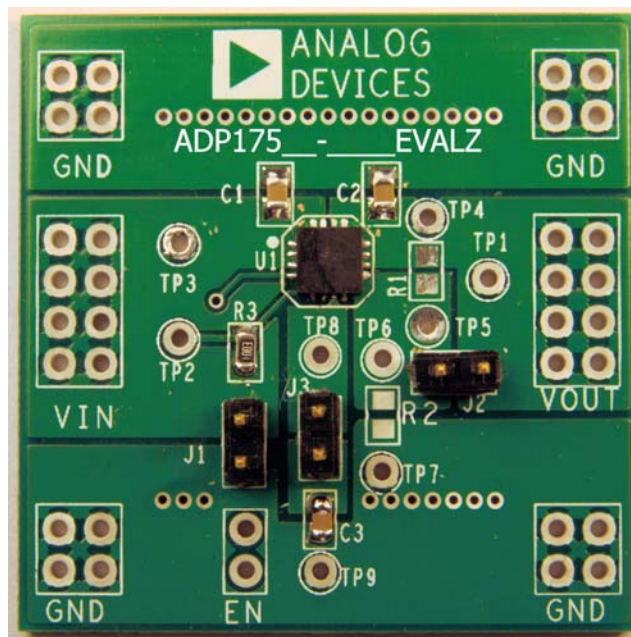
Features	1	Dropout Voltage	5
General Description	1	Ground Current Measurement.....	6
Evaluation Board Digital Picture.....	1	Ground Current Consumption	6
Revision History	2	PCB Layout Considerations.....	7
Evaluation Board Hardware and Schematic	3	Thermal Considerations.....	7
Evaluation Board Configurations	3	Ordering Information.....	11
Output Voltage Measurement.....	4	Bill of Materials.....	11
Line Regulation.....	5	Ordering Guide	11
Load Regulation.....	5	ESD Caution.....	11

REVISION HISTORY

11/08—Revision 0: Initial Version

EVALUATION BOARD HARDWARE AND SCHEMATIC

EVALUATION BOARD CONFIGURATIONS

The ADP1754/ADP1755 evaluation boards are shipped with different components depending on which version is ordered.

Components common to all versions are C1, C2, C3, R3, J1, J2, and J3.

Figure 2 shows the schematic of this evaluation board configuration. Table 1 lists and describes the hardware components.

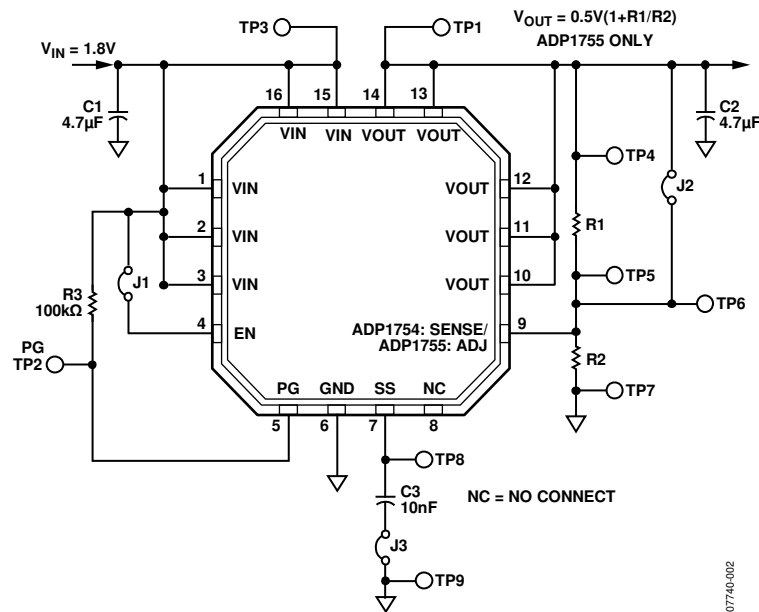

Figure 2. Evaluation Board Schematic

Table 1. Evaluation Board Hardware Components

Component	Function	Description
U1 ¹	Linear regulator	ADP1754 or ADP1755 low dropout linear regulator.
C1	Input capacitor	4.7 µF input bypass capacitor.
C2	Output capacitor	4.7 µF output capacitor. Required for stability and transient performance.
C3	Soft start capacitor	10 nF soft start capacitor.
R1, R2	Output voltage set	Not installed.
R3	Pull-up resistor	100 kΩ pull-up resistor for power good (PG).
J1	Jumper	Jumper. Connects EN to VIN for automatic startup.
J2	Jumper	Jumper. Connects SENSE to VOUT (for ADP1754 only).
J3	Jumper	Jumper. Connects Soft Start Capacitor C3.

¹ Component varies depending on the evaluation board model ordered.

EVAL-ADP1754/ADP1755

OUTPUT VOLTAGE MEASUREMENT

Figure 3 shows how the evaluation board can be connected to a voltage source and a voltmeter for basic output voltage accuracy measurements. A resistor can be used as the load for the regulator.

Ensure that the resistor has a power rating adequate to handle the power expected to be dissipated across it. An electronic load can be used as an alternative. In addition, ensure that the voltage source can supply enough current for the expected load levels.

Follow these steps to connect to a voltage source and voltmeter:

1. Connect the negative terminal (–) of the voltage source to one of the GND pads on the evaluation board.
2. Connect the positive terminal (+) of the voltage source to the VIN pad of the evaluation board.

3. Connect a load between the VOUT pad and one of the GND pads.
4. Connect the negative terminal (–) of the voltmeter to one of the GND pads.
5. Connect the positive terminal (+) of the voltmeter to the VOUT pad.

The voltage source can now be turned on. If J1 is inserted (connecting EN to VIN for automatic startup), the regulator powers up.

If the load current is large, connect the voltmeter as close as possible to the output capacitor to reduce the effects of IR drops.

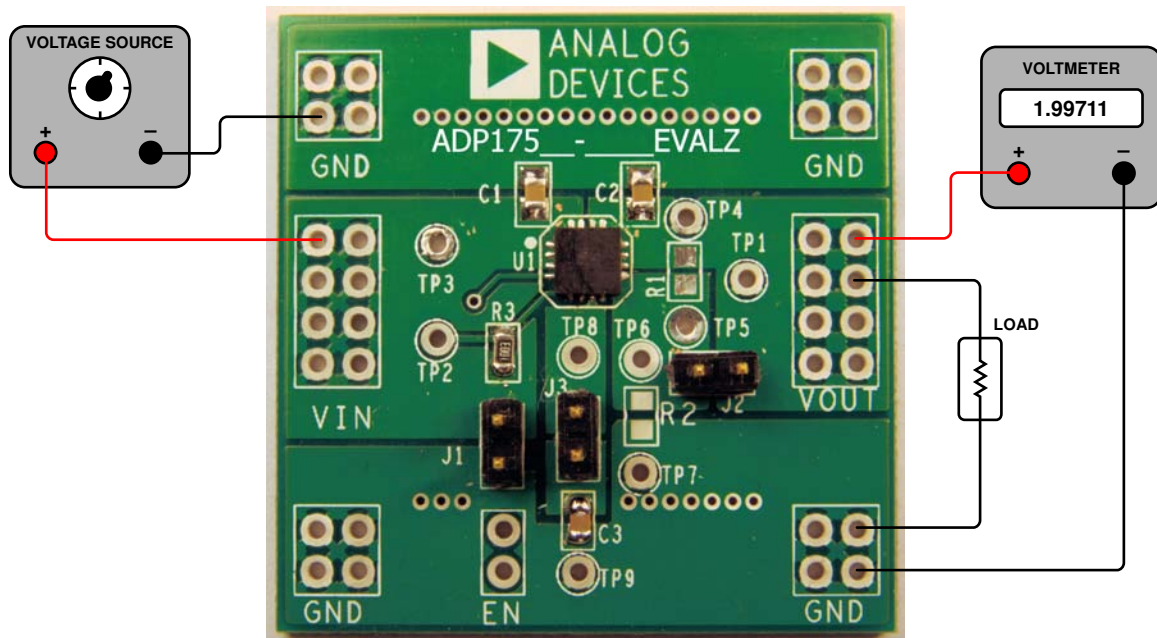

Figure 3. Output Voltage Measurement Setup

07740-003

LINE REGULATION

For line regulation measurements, the regulator output is monitored while its input is varied. For good line regulation, the output must change as little as possible with varying input levels.

To ensure that the device is not in dropout mode during this measurement, V_{IN} must be varied between $V_{OUTNOM} + 0.4 V$ (or $+ 1.6 V$, whichever is greater) and V_{INMAX} . For example, for an ADP1754 with fixed 1.5 V output, V_{IN} needs to be varied between 1.9 V and 3.6 V. This measurement can be repeated under different load conditions. Figure 4 shows the typical line regulation performance of an ADP1754 with fixed 1.5 V output.

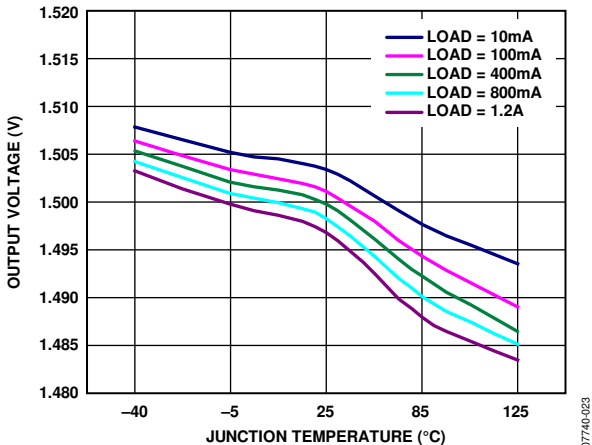

Figure 4. Output Voltage vs. Input Voltage

LOAD REGULATION

For load regulation measurements, the output of the regulator is monitored while the load is varied. For good load regulation, the output must change as little as possible with varying loads.

The input voltage must be held constant during this measurement. The load current can be varied from 500 μA to 1.2 A. Figure 5 shows the typical load regulation performance of an ADP1754 with fixed 1.5 V output for an input voltage of 1.9 V.

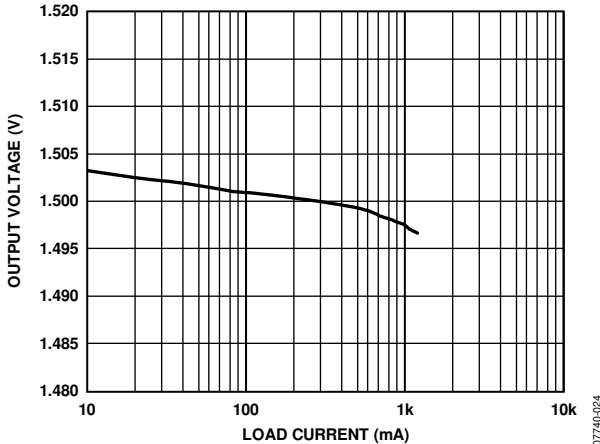

Figure 5. Output Voltage vs. Load Current

DROPOUT VOLTAGE

Dropout voltage can be measured using the configuration shown in Figure 3. Dropout voltage is defined as the input-to-output voltage differential when the input voltage is set to the nominal output voltage. This applies only for output voltages above 1.6 V. Dropout voltage increases with larger loads.

For more accurate measurements, use a second voltmeter to monitor the input voltage across the input capacitor. The input supply voltage may need to be adjusted to account for IR drops, especially if large load currents are used. Figure 6 shows a typical curve of dropout voltage measurements with different load currents.

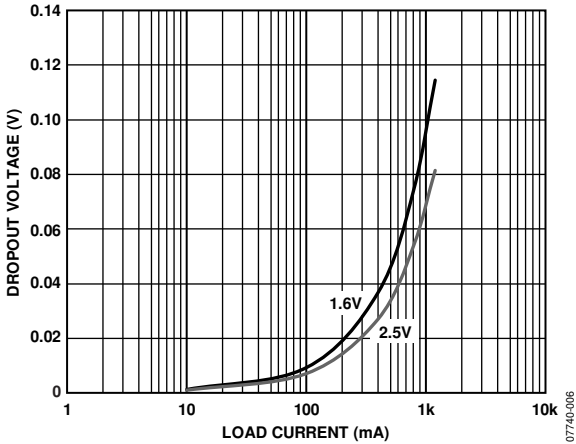

Figure 6. Dropout Voltage vs. Load Current

EVAL-ADP1754/ADP1755

GROUND CURRENT MEASUREMENT

Figure 8 shows how the evaluation board can be connected to a voltage source and an ammeter for ground current measurements. A resistor can be used as the load for the regulator. Ensure that the resistor has a power rating adequate to handle the power expected to be dissipated across it. An electronic load can be used as an alternative. Ensure that the voltage source used can supply enough current for the expected load levels.

Follow these steps to connect to a voltage source and ammeter:

1. Connect the positive terminal (+) of the voltage source to the VIN pad on the evaluation board.
2. Connect the positive terminal (+) of the ammeter to one of the GND pads of the evaluation board.
3. Connect the negative terminal (-) of the ammeter to the negative (-) terminal of the voltage source.
4. Connect a load between the VOUT pad of the evaluation board and the negative (-) terminal of the voltage source.

The voltage source can now be turned on. If J1 is inserted (EN is connected to VIN for automatic startup), the regulator powers up.

GROUND CURRENT CONSUMPTION

Ground current measurements can determine how much current the internal circuits of the regulator are consuming while the circuits perform the regulation function. To be efficient, the regulator needs to consume as little current as possible. Typically, the regulator uses the maximum current when supplying its largest load level (1.2 A). Figure 7 shows the typical ground current consumption for various load levels at $V_{IN} = 1.9\text{ V}$. When the device is disabled ($EN = \text{GND}$), ground current drops to less than $6\text{ }\mu\text{A}$.

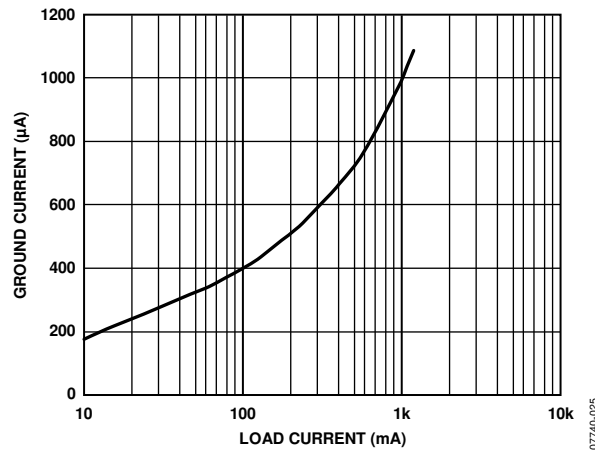

Figure 7. Ground Current vs. Load Current

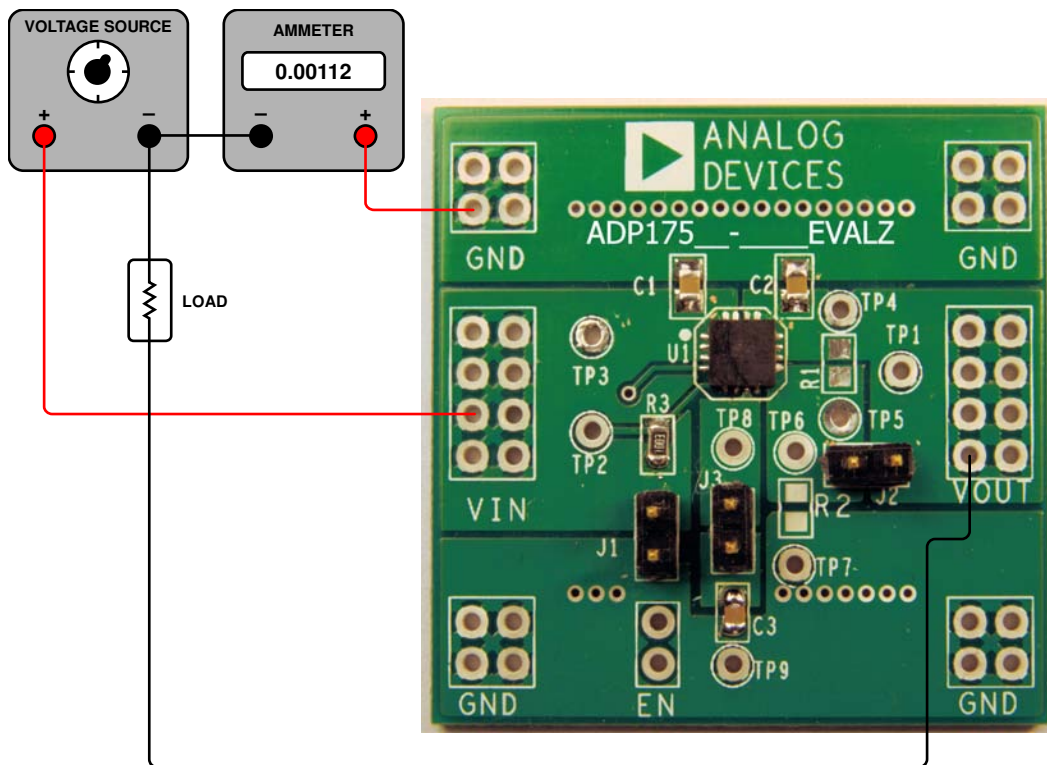

Figure 8. Ground Current Measurement

PCB LAYOUT CONSIDERATIONS

Heat dissipation from the package can be improved by increasing the amount of copper attached to the pins of the ADP1754/ADP1755. However, as shown in Table 2, a point of diminishing returns is eventually reached, beyond which an increase in the copper size does not yield significant heat dissipation benefits.

Here are a few general tips when designing PCBs:

- Place the input capacitor as close as possible to the VIN and GND pins.
- Place the output capacitor as close as possible to the VOUT and GND pins.
- Place the soft start capacitor close to the SS pin.
- Connect the load as close as possible to the VOUT and SENSE pins (ADP1754) or to the VOUT and ADJ pins (ADP1755).

Use of 0603 or 0805 size capacitors and resistors achieves the smallest possible footprint solution on boards where area is limited.

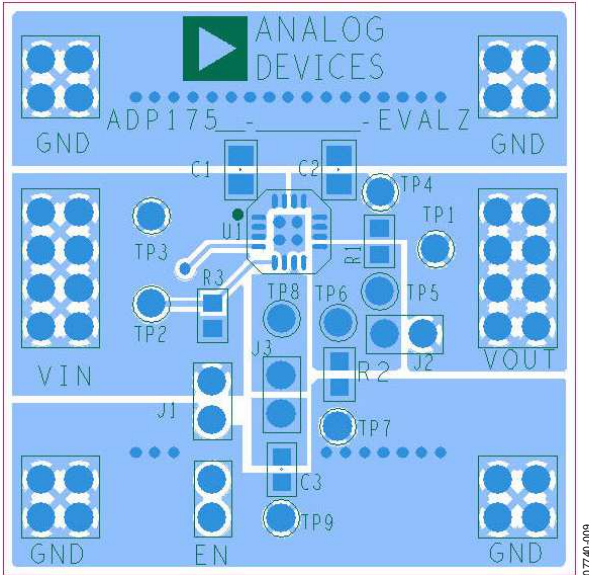

Figure 9. Typical Board Layout, Top Side

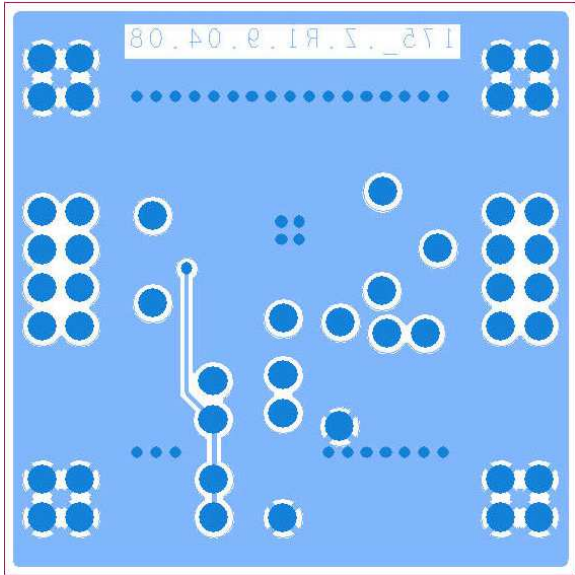

Figure 10. Typical Board Layout, Bottom Side

THERMAL CONSIDERATIONS

To guarantee reliable operation, the junction temperature of the ADP1754/ADP1755 must not exceed 125°C. To ensure that the junction temperature stays below this maximum value, the user needs to be aware of the parameters that contribute to junction temperature changes. These parameters include ambient temperature, power dissipation in the power device, and thermal resistance between the junction and ambient air (θ_{JA}). The θ_{JA} value is dependent on the package assembly compounds used and the amount of copper to which the GND pins of the package are soldered on the PCB. Table 2 shows typical θ_{JA} values of the 16-lead LFCSP for various PCB copper sizes. Table 3 shows the typical Ψ_{JB} value of the 16-lead LFCSP.

Table 2. Typical θ_{JA} Values

Copper Size (mm ²)	θ_{JA} (°C/W), LFCSP
0 ¹	130
100	80
500	69
1000	54
6400	42

¹ Device soldered to minimum size pin traces.

Table 3. Typical Ψ_{JB} Values

Copper Size (mm ²)	Ψ_{JB} (°C/W) @ 1W
100	32.7
500	31.5
1000	25.5

EVAL-ADP1754/ADP1755

The junction temperature of the ADP1754/ADP1755 can be calculated from the following equation:

$$T_j = T_A + (P_D \times \theta_{JA}) \quad (1)$$

where:

T_A is the ambient temperature.

P_D is the power dissipation in the die, given by

$$P_D = [(V_{IN} - V_{OUT}) \times I_{LOAD}] + (V_{IN} \times I_{GND}) \quad (2)$$

where:

V_{IN} and V_{OUT} are the input and output voltages, respectively.

I_{LOAD} is the load current.

I_{GND} is the ground current.

Power dissipation due to ground current is quite small and can be ignored. Therefore, the junction temperature equation can be simplified as follows:

$$T_j = T_A + \{[(V_{IN} - V_{OUT}) \times I_{LOAD}] \times \theta_{JA}\} \quad (3)$$

As shown in Equation 3, for a given ambient temperature, input-to-output voltage differential, and continuous load current, a minimum copper size requirement exists for the PCB to ensure that the junction temperature does not rise above 125°C. Figure 11 through Figure 16 show junction temperature calculations for different ambient temperatures, load currents, V_{IN} to V_{OUT} differentials, and areas of PCB copper.

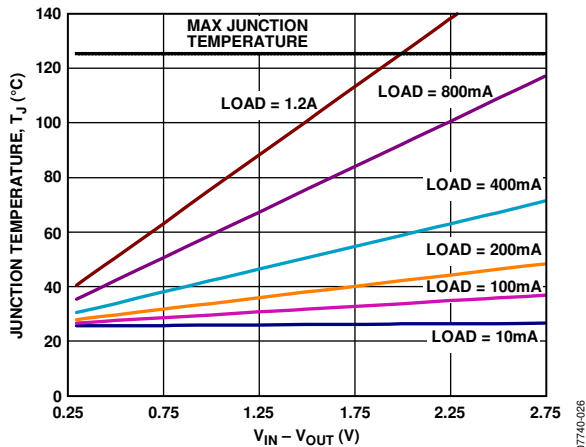

Figure 11. 6400 mm² of PCB Copper, $T_A = 25^\circ\text{C}$, LFCSP

07740-028

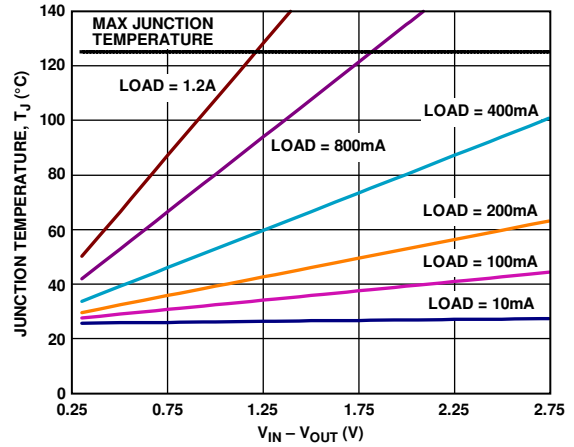

Figure 12. 500 mm² of PCB Copper, $T_A = 25^\circ\text{C}$, LFCSP

07740-027

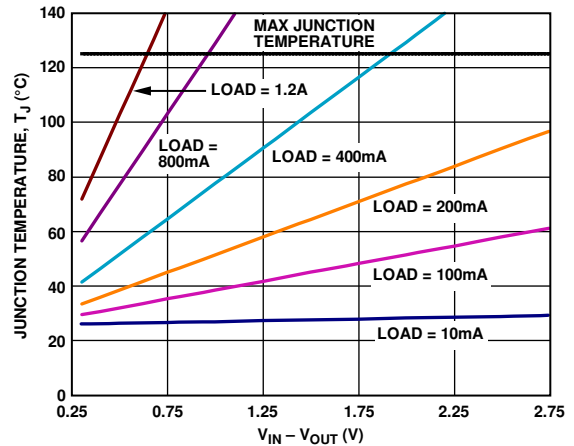

Figure 13. 0 mm² of PCB Copper, $T_A = 25^\circ\text{C}$, LFCSP

07740-028

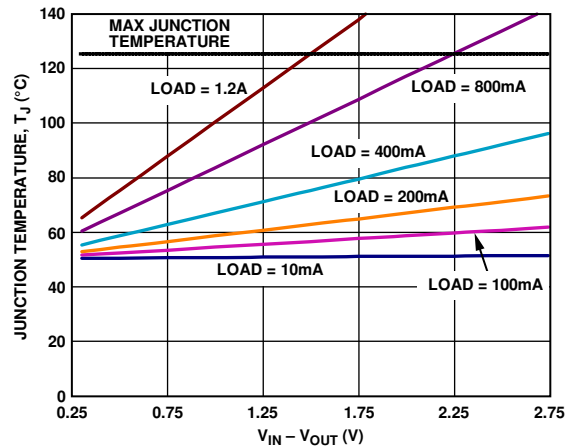

Figure 14. 6400 mm² of PCB Copper, $T_A = 50^\circ\text{C}$, LFCSP

07740-028

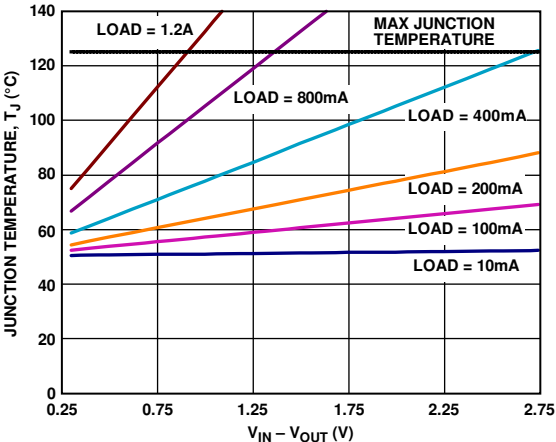

Figure 15. 500 mm² of PCB Copper, T_A = 50°C, LFCSP

07740-030

In cases where the board temperature is known, the thermal characterization parameter, Ψ_{JB} , can be used to estimate the junction temperature rise. Maximum junction temperature (T_J) is calculated from the board temperature (T_B) and power dissipation (P_D) using the following formula:

$$T_J = T_B + (P_D \times \Psi_{JB}) \tag{4}$$

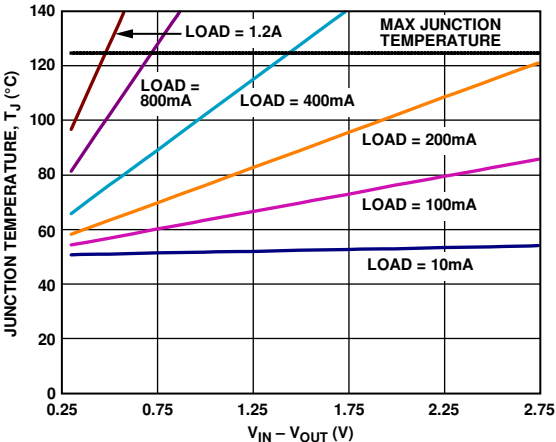

Figure 16. 0 mm² of PCB Copper, T_A = 50°C, LFCSP

07740-031

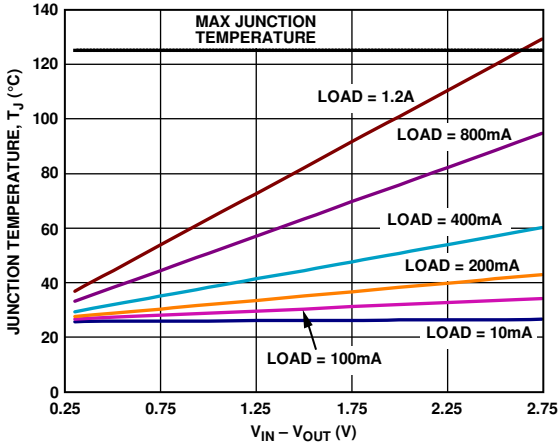

Figure 17. 500 mm² of PCB Copper, T_B = 25°C, LFCSP

07740-032

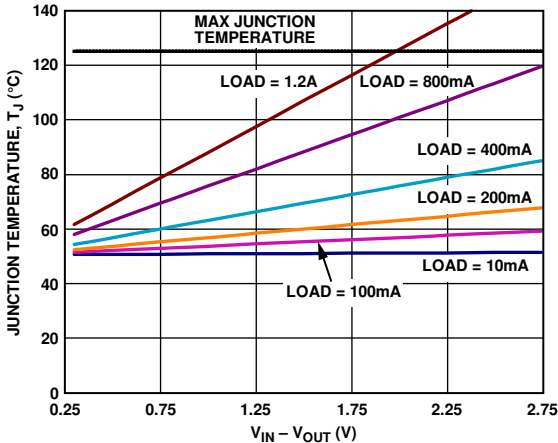

Figure 18. 500 mm² of PCB Copper, T_B = 50°C, LFCSP

07740-033

EVAL-ADP1754/ADP1755

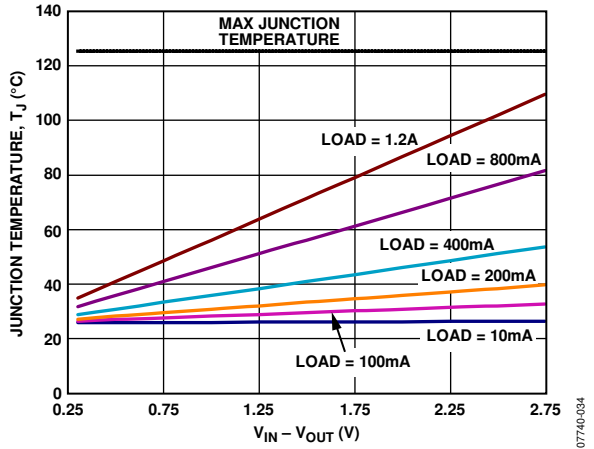

Figure 19. 1000 mm² of PCB Copper, $T_B = 25^\circ\text{C}$, LFCSP

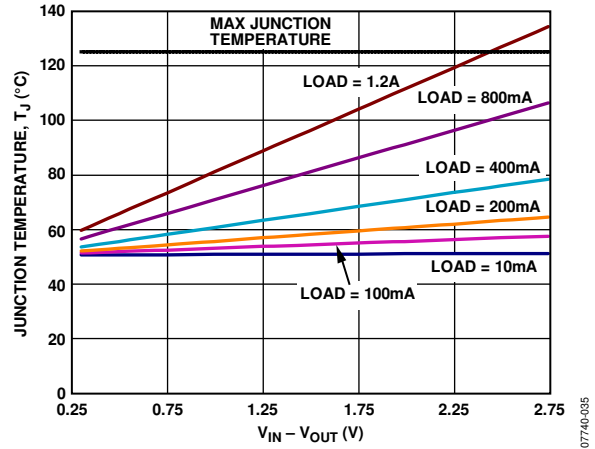

Figure 20. 1000 mm² of PCB Copper, $T_B = 50^\circ\text{C}$, LFCSP

ORDERING INFORMATION**BILL OF MATERIALS**

Table 4

Qty	Reference Designator	Description	Manufacturer/Vendor	Vendor Part No.
2	C1, C2	Capacitor, MLCC, 4.7 μ F, 6.3 V, 0805, X5R	Murata or equivalent	GRM219R61A475KE34
1	C3	Capacitor, MLCC, 10 nF, 50 V, 0603, X5R	Murata or equivalent	GRM188R71H103KA01
3	J1, J2, J3	Header, single, STR, 2 pins	Digi-Key Corp.	S1012E-36-ND
1	R3	Resistor, 100 k Ω , 0.10 W, 0603	Vishay or equivalent	CRCW0603100KFKEA
2	R1, R2	Resistor, 0.10 W, 0603	Vishay or equivalent	Not installed
1	U1	IC, LDO regulator	Analog Devices, Inc.	ADP1755ACPZ-R7, ADP1754ACPZ-1.5-R7

ORDERING GUIDE

Model	Output Voltage (V)	Description
ADP1754-1.5-EVALZ ¹	1.5	Fixed 1.5 V Output Evaluation Board
ADP1755-EVALZ ¹	Adjustable	Adjustable Output Evaluation Board

¹ Z = RoHS Compliant Part.**ESD CAUTION**

ESD (electrostatic discharge) sensitive device. Charged devices and circuit boards can discharge without detection. Although this product features patented or proprietary protection circuitry, damage may occur on devices subjected to high energy ESD. Therefore, proper ESD precautions should be taken to avoid performance degradation or loss of functionality.

NOTES