



Chipsmall Limited consists of a professional team with an average of over 10 year of expertise in the distribution of electronic components. Based in Hongkong, we have already established firm and mutual-benefit business relationships with customers from,Europe,America and south Asia,supplying obsolete and hard-to-find components to meet their specific needs.

With the principle of “Quality Parts,Customers Priority,Honest Operation,and Considerate Service”,our business mainly focus on the distribution of electronic components. Line cards we deal with include Microchip,ALPS,ROHM,Xilinx,Pulse,ON,Everlight and Freescale. Main products comprise IC,Modules,Potentiometer,IC Socket,Relay,Connector.Our parts cover such applications as commercial,industrial, and automotives areas.

We are looking forward to setting up business relationship with you and hope to provide you with the best service and solution. Let us make a better world for our industry!



Contact us

Tel: +86-755-8981 8866 Fax: +86-755-8427 6832

Email & Skype: info@chipsmall.com Web: www.chipsmall.com

Address: A1208, Overseas Decoration Building, #122 Zhenhua RD., Futian, Shenzhen, China





FEATURES

- High common-mode transient immunity: 100 kV/μs**
- High robustness to radiated and conducted noise**
- Low propagation delay**
 - 13 ns maximum for 5 V operation**
 - 15 ns maximum for 1.8 V operation**
- 150 Mbps maximum data rate**
- Safety and regulatory approvals (pending)**
 - UL recognition**
 - 5000 V rms for 1 minute per UL 1577**
 - CSA Component Acceptance Notice 5A**
 - VDE certificate of conformity**
 - DIN V VDE V 0884-10 (VDE V 0884-10):2006-12**
 - V_{IORM} = 849 V peak**
 - CQC Certification per GB4943.1-2011**
- Low dynamic power consumption**
- 1.8 V to 5 V level translation**
- High temperature operation: 125°C maximum**
- Fail-safe high or low options**
- 8-lead, RoHS-compliant, SOIC_IC package**

APPLICATIONS

- General-purpose single-channel isolation**
- Industrial field bus isolation**

GENERAL DESCRIPTION

The ADuM210N¹ is a single-channel digital isolator based on Analog Devices, Inc., iCoupler® technology. Combining high speed, complementary metal-oxide semiconductor (CMOS) and monolithic air core transformer technology, this isolation component provides outstanding performance characteristics, superior to alternatives such as optocoupler devices and other integrated couplers. The maximum propagation delay is 13 ns with a pulse width distortion of less than 3 ns at 5 V operation.

The ADuM210N supports data rates as high as 150 Mbps with a withstand voltage rating of 5.0 kV rms (see the Ordering Guide). The device operates with the supply voltage on either side ranging from 1.8 V to 5 V, providing compatibility with lower voltage systems as well as enabling voltage translation functionality across the isolation barrier.

Unlike other optocoupler alternatives, dc correctness is ensured in the absence of input logic transitions. Two different fail-safe options are available, in which the outputs transition to a pre-determined state when the input power supply is not applied or the inputs are disabled.

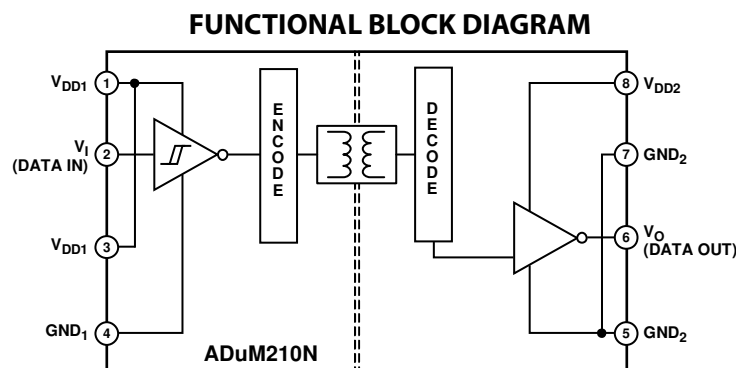

Figure 1.

¹ Protected by U.S. Patents 5,952,849; 6,873,065; 6,903,578; and 7,075,329. Other patents are pending.

ADUM210N* PRODUCT PAGE QUICK LINKS

Last Content Update: 02/23/2017

COMPARABLE PARTS

View a parametric search of comparable parts.

EVALUATION KITS

- Evaluation Board for Single and Dual Channel Standard Data Isolators in 8 lead SOIC Package

DOCUMENTATION

Data Sheet

- ADuM210N: 5.0 kV rms, Single-Channel Digital Isolator Data Sheet

User Guides

- UG-937: Using the EVAL-1CH2CHSOICEBZ iCoupler Standard Data Isolator Evaluation Board

TOOLS AND SIMULATIONS

- ADuM110N/ADUM210N IBIS Model

DESIGN RESOURCES

- ADuM210N Material Declaration
- PCN-PDN Information
- Quality And Reliability
- Symbols and Footprints

DISCUSSIONS

View all ADuM210N EngineerZone Discussions.

SAMPLE AND BUY

Visit the product page to see pricing options.

TECHNICAL SUPPORT

Submit a technical question or find your regional support number.

DOCUMENT FEEDBACK

Submit feedback for this data sheet.

TABLE OF CONTENTS

Features	1	Recommended Operating Conditions	8
Applications	1	Absolute Maximum Ratings	9
General Description	1	ESD Caution.....	9
Functional Block Diagram	1	Pin Configuration and Function Descriptions.....	10
Revision History	2	Typical Performance Characteristics	11
Specifications.....	3	Applications Information	12
Electrical Characteristics—5 V Operation.....	3	Overview	12
Electrical Characteristics—3.3 V Operation	4	PCB Layout	12
Electrical Characteristics—2.5 V Operation	5	Propagation Delay Related Parameters	13
Electrical Characteristics—1.8 V Operation	6	Jitter Measurement.....	13
Insulation and Safety Related Specifications	7	Insulation Lifetime.....	13
Package Characteristics	7	Outline Dimensions	15
Regulatory Information.....	7	Ordering Guide	15
DIN V VDE V 0884-10 (VDE V 0884-10) Insulation Characteristics	8		

REVISION HISTORY

4/16—Revision 0: Initial Version

SPECIFICATIONS

ELECTRICAL CHARACTERISTICS—5 V OPERATION

All typical specifications are at $T_A = 25^\circ\text{C}$, $V_{DD1} = V_{DD2} = 5\text{ V}$. Minimum/maximum specifications apply over the entire recommended operation range of $4.5\text{ V} \leq V_{DD1} \leq 5.5\text{ V}$, $4.5\text{ V} \leq V_{DD2} \leq 5.5\text{ V}$, and $-40^\circ\text{C} \leq T_A \leq +125^\circ\text{C}$, unless otherwise noted. Switching specifications are tested with $C_L = 15\text{ pF}$ and CMOS signal levels, unless otherwise noted. Supply currents are specified with 50% duty cycle signals.

Table 1.

Parameter	Symbol	Min	Typ	Max	Unit	Test Conditions/Comments
SWITCHING SPECIFICATIONS						
Pulse Width	PW	6.6			ns	Within pulse width distortion (PWD) limit
Data Rate		150			Mbps	Within PWD limit
Propagation Delay	t_{PHL} , t_{PLH}	4.8	7.2	13	ns	50% input to 50% output
Pulse Width Distortion	PWD		0.5	3	ns	$ t_{PLH} - t_{PHL} $
Change vs. Temperature			1.5		ps/ $^\circ\text{C}$	
Propagation Delay Skew	t_{PSK}			6.0	ns	Between any two units at the same temperature, voltage, and load
Jitter			380		ps p-p	See the Jitter Measurement section
			55		ps rms	See the Jitter Measurement section
DC SPECIFICATIONS						
Input Threshold						
Logic High	V_{IH}	$0.7 \times V_{DD1}$			V	
Logic Low	V_{IL}			$0.3 \times V_{DD1}$	V	
Output Voltage						
Logic High	V_{OH}	$V_{DD2} - 0.1$	V_{DD2}		V	Output load (I_O) = $-20\text{ }\mu\text{A}$, $V_I = V_{IH}$
		$V_{DD2} - 0.4$	$V_{DD2} - 0.2$		V	$I_O = -4\text{ mA}$, $V_I = V_{IH}$
Logic Low	V_{OL}		0.0	0.1	V	$I_O = 20\text{ }\mu\text{A}$, $V_I = V_{IL}$
			0.2	0.4	V	$I_O = 4\text{ mA}$, $V_I = V_{IL}$
Input Current per Channel	I_i	-10	+0.01	+10	μA	$0\text{ V} \leq V_I \leq V_{DD1}$
Quiescent Supply Current	$I_{DD1(Q)}$		0.9	1.4	mA	$V_I = 0\text{ (N0)}$, 1 (N1)^1
	$I_{DD2(Q)}$		1.0	1.3	mA	$V_I = 0\text{ (N0)}$, 1 (N1)^1
	$I_{DD1(Q)}$		3.6	6.0	mA	$V_I = 1\text{ (N0)}$, 0 (N1)^1
	$I_{DD2(Q)}$		1.0	1.4	mA	$V_I = 1\text{ (N0)}$, 0 (N1)^1
Dynamic Supply Current						
Dynamic Input	$I_{DD1(D)}$		0.01		mA/Mbps	Inputs switching, 50% duty cycle
Dynamic Output	$I_{DDO(D)}$		0.02		mA/Mbps	Inputs switching, 50% duty cycle
Undervoltage Lockout	UVLO					
Positive V_{DDx} Threshold	V_{DDxUV+}		1.6		V	
Negative V_{DDx} Threshold	V_{DDxUV-}		1.5		V	
V_{DDx} Hysteresis	V_{DDxUVH}		0.1		V	
AC SPECIFICATIONS						
Output Rise/Fall Time	t_R/t_F		2.5		ns	10% to 90%
Common-Mode Transient Immunity ²	$ CM_H $	75	100		kV/ μs	$V_I = V_{DD1}$, $V_{CM} = 1000\text{ V}$, transient magnitude = 800 V
	$ CM_L $	75	100		kV/ μs	$V_I = 0\text{ V}$, $V_{CM} = 1000\text{ V}$, transient magnitude = 800 V

¹ N0 indicates the ADuM210N0 models and N1 indicates the ADuM210N1 models. See the Ordering Guide.

² $|CM_H|$ is the maximum common-mode voltage slew rate that can be sustained while maintaining the voltage output (V_O) $> 0.8 \times V_{DD2}$. $|CM_L|$ is the maximum common-mode voltage slew rate that can be sustained while maintaining $V_O > 0.8\text{ V}$. The common-mode voltage slew rates apply to both the rising and falling common-mode voltage edges.

Table 2. Total Supply Current vs. Data Throughput—5 V Operation

Parameter	Symbol	1 Mbps			25 Mbps			100 Mbps			Unit
		Min	Typ	Max	Min	Typ	Max	Min	Typ	Max	
SUPPLY CURRENT											
Supply Current Side 1	I _{DD1}		2.2	3.7		2.5	3.9		3.6	4.9	mA
Supply Current Side 2	I _{DD2}		1.1	1.6		1.6	2.3		3.1	4.6	mA

ELECTRICAL CHARACTERISTICS—3.3 V OPERATION

All typical specifications are at $T_A = 25^\circ\text{C}$, $V_{DD1} = V_{DD2} = 3.3\text{ V}$. Minimum/maximum specifications apply over the entire recommended operation range: $3.0\text{ V} \leq V_{DD1} \leq 3.6\text{ V}$, $3.0\text{ V} \leq V_{DD2} \leq 3.6\text{ V}$, and $-40^\circ\text{C} \leq T_A \leq +125^\circ\text{C}$, unless otherwise noted. Switching specifications are tested with $C_L = 15\text{ pF}$ and CMOS signal levels, unless otherwise noted. Supply currents are specified with 50% duty cycle signals.

Table 3.

Parameter	Symbol	Min	Typ	Max	Unit	Test Conditions/Comments
SWITCHING SPECIFICATIONS						
Pulse Width	PW	6.6			ns	Within PWD limit
Data Rate		150			Mbps	Within PWD limit
Propagation Delay	t _{PHL} , t _{PLH}	4.8	6.8	14	ns	50% input to 50% output
Pulse Width Distortion	PWD		0.7	3	ns	t _{PLH} - t _{PHL}
Change vs. Temperature			1.5		ps/°C	
Propagation Delay Skew	t _{PSK}			7.0	ns	Between any two units at the same temperature, voltage, and load
Jitter			290		ps p-p	See the Jitter Measurement section
			45		ps rms	See the Jitter Measurement section
DC SPECIFICATIONS						
Input Threshold						
Logic High	V _{IH}	0.7 × V _{DD1}			V	
Logic Low	V _{IL}			0.3 × V _{DD1}	V	
Output Voltage						
Logic High	V _{OH}	V _{DD2} - 0.1	V _{DD2}		V	I _O = -20 μA, V _I = V _{IH}
Logic Low	V _{OL}	V _{DD2} - 0.4	V _{DD2} - 0.2		V	I _O = -2 mA, V _I = V _{IH}
Logic Low			0.0	0.1	V	I _O = 20 μA, V _I = V _{IL}
Logic Low			0.2	0.4	V	I _O = 2 mA, V _I = V _{IL}
Input Current per Channel	I _I	-10	+0.01	+10	μA	0 V ≤ V _I ≤ V _{DD1}
Quiescent Supply Current	I _{DD1(Q)}		0.8	1.3	mA	V _I = 0 (N0), 1 (N1) ¹
	I _{DD2(Q)}		0.9	1.4	mA	V _I = 0 (N0), 1 (N1) ¹
	I _{DD1(Q)}		3.6	5.8	mA	V _I = 1 (N0), 0 (N1) ¹
	I _{DD2(Q)}		0.9	1.4	mA	V _I = 1 (N0), 0 (N1) ¹
Dynamic Supply Current						
Dynamic Input	I _{DD1(D)}		0.01		mA/Mbps	Inputs switching, 50% duty cycle
Dynamic Output	I _{DDO(D)}		0.01		mA/Mbps	Inputs switching, 50% duty cycle
Undervoltage Lockout	UVLO					
Positive V _{DDx} Threshold	V _{DDxUV+}		1.6		V	
Negative V _{DDx} Threshold	V _{DDxUV-}		1.5		V	
V _{DDx} Hysteresis	V _{DDxUVH}		0.1		V	
AC SPECIFICATIONS						
Output Rise/Fall Time	t _R /t _F		2.5		ns	10% to 90%
Common-Mode Transient Immunity ²	CM _H	75	100		kV/μs	V _I = V _{DD1} , V _{CM} = 1000 V, transient magnitude = 800 V
	CM _L	75	100		kV/μs	V _I = 0 V, V _{CM} = 1000 V, transient magnitude = 800 V

¹ N0 indicates the ADuM210N0 models and N1 indicates the ADuM210N1 models. See the Ordering Guide.

² |CM_H| is the maximum common-mode voltage slew rate that can be sustained while maintaining the voltage output (V_O) > 0.8 × V_{DD2}. |CM_L| is the maximum common-mode voltage slew rate that can be sustained while maintaining V_O > 0.8 V. The common-mode voltage slew rates apply to both rising and falling common-mode voltage edges.

Table 4. Total Supply Current vs. Data Throughput—3.3 V Operation

Parameter	Symbol	1 Mbps			25 Mbps			100 Mbps			Unit
		Min	Typ	Max	Min	Typ	Max	Min	Typ	Max	
SUPPLY CURRENT											
Supply Current Side 1	I _{DD1}		2.2	3.5		2.4	3.6		3.2	4.6	mA
Supply Current Side 2	I _{DD2}		0.9	1.5		1.4	2.0		2.8	4.3	mA

ELECTRICAL CHARACTERISTICS—2.5 V OPERATION

All typical specifications are at T_A = 25°C, V_{DD1} = V_{DD2} = 2.5 V. Minimum/maximum specifications apply over the entire recommended operation range: 2.25 V ≤ V_{DD1} ≤ 2.75 V, 2.25 V ≤ V_{DD2} ≤ 2.75 V, -40°C ≤ T_A ≤ +125°C, unless otherwise noted. Switching specifications are tested with C_L = 15 pF and CMOS signal levels, unless otherwise noted. Supply currents are specified with 50% duty cycle signals.

Table 5.

Parameter	Symbol	Min	Typ	Max	Unit	Test Conditions/Comments
SWITCHING SPECIFICATIONS						
Pulse Width	PW	6.6			ns	Within PWD limit
Data Rate		150			Mbps	Within PWD limit
Propagation Delay	t _{PHL} , t _{PLH}	5.0	7.0	14	ns	50% input to 50% output
Pulse Width Distortion	PWD		0.7	3	ns	t _{PLH} - t _{PHL}
Change vs. Temperature			1.5		ps/°C	
Propagation Delay Skew	t _{PSK}			7.0	ns	Between any two units at the same temperature, voltage, and load
Jitter			320		ps p-p	See the Jitter Measurement section
			65		ps rms	See the Jitter Measurement section
DC SPECIFICATIONS						
Input Threshold						
Logic High	V _{IH}	0.7 × V _{DD1}			V	
Logic Low	V _{IL}			0.3 × V _{DD1}	V	
Output Voltage						
Logic High	V _{OH}	V _{DD2} - 0.1	V _{DD2}		V	I _O = -20 μA, V _I = V _{IH}
		V _{DD2} - 0.4	V _{DD2} - 0.2		V	I _O = -2 mA, V _I = V _{IH}
Logic Low	V _{OL}		0.0	0.1	V	I _O = 20 μA, V _I = V _{IL}
			0.2	0.4	V	I _O = 2 mA, V _I = V _{IL}
Input Current per Channel	I _I	-10	+0.01	+10	μA	0 V ≤ V _I ≤ V _{DD1}
Quiescent Supply Current	I _{DD1(Q)}		0.8	1.1	mA	V _I = 0 (N0), 1 (N1) ¹
	I _{DD2(Q)}		0.9	1.2	mA	V _I = 0 (N0), 1 (N1) ¹
	I _{DD1(Q)}		3.5	5.6	mA	V _I = 1 (N0), 0 (N1) ¹
	I _{DD2(Q)}		1.0	1.2	mA	V _I = 1 (N0), 0 (N1) ¹
Dynamic Supply Current						
Dynamic Input	I _{DDI(D)}		0.01		mA/Mbps	Inputs switching, 50% duty cycle
Dynamic Output	I _{DDO(D)}		0.01		mA/Mbps	Inputs switching, 50% duty cycle
Undervoltage Lockout	UVLO					
Positive V _{DDx} Threshold	V _{DDxUV+}		1.6		V	
Negative V _{DDx} Threshold	V _{DDxUV-}		1.5		V	
V _{DDx} Hysteresis	V _{DDxUVH}		0.1		V	
AC SPECIFICATIONS						
Output Rise/Fall Time	t _R /t _F		2.5		ns	10% to 90%
Common-Mode Transient Immunity ²	CM _H	75	100		kV/μs	V _I = V _{DD1} , V _{CM} = 1000 V, transient magnitude = 800 V
	CM _L	75	100		kV/μs	V _I = 0 V, V _{CM} = 1000 V, transient magnitude = 800 V

¹ N0 indicates the ADuM210N0 models and N1 indicates the ADuM210N1 models. See the Ordering Guide.

² |CM_H| is the maximum common-mode voltage slew rate that can be sustained while maintaining the voltage output (V_O) > 0.8 × V_{DD2}. |CM_L| is the maximum common-mode voltage slew rate that can be sustained while maintaining V_O > 0.8 V. The common-mode voltage slew rates apply to both rising and falling common-mode voltage edges.

Table 6. Total Supply Current vs. Data Throughput—2.5 V Operation

Parameter	Symbol	1 Mbps			25 Mbps			100 Mbps			Unit
		Min	Typ	Max	Min	Typ	Max	Min	Typ	Max	
SUPPLY CURRENT											
Supply Current Side 1	I _{DD1}		2.2	3.4		2.4	3.6		3.2	4.3	mA
Supply Current Side 2	I _{DD2}		0.9	1.4		1.3	1.8		2.3	3.5	mA

ELECTRICAL CHARACTERISTICS—1.8 V OPERATION

All typical specifications are at T_A = 25°C, V_{DD1} = V_{DD2} = 1.8 V. Minimum/maximum specifications apply over the entire recommended operation range: 1.7 V ≤ V_{DD1} ≤ 1.9 V, 1.7 V ≤ V_{DD2} ≤ 1.9 V, and -40°C ≤ T_A ≤ +125°C, unless otherwise noted. Switching specifications are tested with C_L = 15 pF and CMOS signal levels, unless otherwise noted. Supply currents are specified with 50% duty cycle signals.

Table 7.

Parameter	Symbol	Min	Typ	Max	Unit	Test Conditions/Comments
SWITCHING SPECIFICATIONS						
Pulse Width	PW	6.6			ns	Within PWD limit
Data Rate		150			Mbps	Within PWD limit
Propagation Delay	t _{PHL} , t _{PLH}	5.8	8.7	15	ns	50% input to 50% output
Pulse Width Distortion	PWD		0.7	3	ns	t _{PLH} - t _{PHL}
Change vs. Temperature			1.5		ps/°C	
Propagation Delay Skew	t _{PSK}			7.0	ns	Between any two units at the same temperature, voltage, and load
Jitter			630		ps p-p	See the Jitter Measurement section
			190		ps rms	See the Jitter Measurement section
DC SPECIFICATIONS						
Input Threshold						
Logic High	V _{IH}	0.7 × V _{DD1}			V	
Logic Low	V _{IL}			0.3 × V _{DD1}	V	
Output Voltage						
Logic High	V _{OH}	V _{DD2} - 0.1	V _{DD2}		V	I _O = -20 μA, V _I = V _{IH}
		V _{DD2} - 0.4	V _{DD2} - 0.2		V	I _O = -2 mA, V _I = V _{IH}
Logic Low	V _{OL}		0.0	0.1	V	I _O = 20 μA, V _I = V _{IL}
			0.2	0.4	V	I _O = 2 mA, V _I = V _{IL}
Input Current per Channel	I _I	-10	+0.01	+10	μA	0 V ≤ V _I ≤ V _{DD1}
Quiescent Supply Current	I _{DD1(Q)}		0.7	1.1	mA	V _I = 0 (N0), 1 (N1) ¹
	I _{DD2(Q)}		0.9	1.2	mA	V _I = 0 (N0), 1 (N1) ¹
	I _{DD1(Q)}		3.4	5.4	mA	V _I = 1 (N0), 0 (N1) ¹
	I _{DD2(Q)}		0.9	1.2	mA	V _I = 1 (N0), 0 (N1) ¹
Dynamic Supply Current						
Dynamic Input	I _{DDI(D)}		0.01		mA/Mbps	Inputs switching, 50% duty cycle
Dynamic Output	I _{DDO(D)}		0.01		mA/Mbps	Inputs switching, 50% duty cycle
Undervoltage Lockout	UVLO					
Positive V _{DDx} Threshold	V _{DDxUV+}		1.6		V	
Negative V _{DDx} Threshold	V _{DDxUV-}		1.5		V	
V _{DDx} Hysteresis	V _{DDxUVH}		0.1		V	
AC SPECIFICATIONS						
Output Rise/Fall Time	t _R /t _F		2.5		ns	10% to 90%
Common-Mode Transient Immunity ²	CM _H	75	100		kV/μs	V _I = V _{DD1} , V _{CM} = 1000 V, transient magnitude = 800 V
	CM _L	75	100		kV/μs	V _I = 0 V, V _{CM} = 1000 V, transient magnitude = 800 V

¹ N0 indicates the ADuM210N0 models and N1 indicates the ADuM210N1 models. See the Ordering Guide.

² |CM_H| is the maximum common-mode voltage slew rate that can be sustained while maintaining the voltage output (V_O) > 0.8 × V_{DD2}. |CM_L| is the maximum common-mode voltage slew rate that can be sustained while maintaining V_O > 0.8 V. The common-mode voltage slew rates apply to both rising and falling common-mode voltage edges.

Table 8. Total Supply Current vs. Data Throughput—1.8 V Operation

Parameter	Symbol	1 Mbps			25 Mbps			100 Mbps			Unit
		Min	Typ	Max	Min	Typ	Max	Min	Typ	Max	
SUPPLY CURRENT											
Supply Current Side 1	I _{DD1}		2.1	3.1		2.3	3.4		3.0	4.2	mA
Supply Current Side 2	I _{DD2}		0.9	1.2		1.2	1.6		2.2	3.2	mA

INSULATION AND SAFETY RELATED SPECIFICATIONS

For additional information, see www.analog.com/icouplersafety.

Table 9.

Parameter	Symbol	Value	Unit	Test Conditions/Comments
Rated Dielectric Insulation Voltage		5000	V rms	1-minute duration
Minimum External Air Gap (Clearance)	L (I01)	8.0	mm min	Measured from input terminals to output terminals, shortest distance through air
Minimum External Tracking (Creepage)	L (I02)	8.0	mm min	Measured from input terminals to output terminals, shortest distance path along body
Minimum Clearance in the Plane of the Printed Circuit Board (PCB Clearance)	L (PCB)	8.3	mm min	Measured from input terminals to output terminals, shortest distance through air, line of sight, in the PCB mounting plane
Minimum Internal Gap (Internal Clearance)		25.5	µm min	Insulation distance through insulation
Tracking Resistance (Comparative Tracking Index)	CTI	>400	V	DIN IEC 112/VDE 0303 Part 1
Material Group		II		Material Group (DIN VDE 0110, 1/89, Table 1)

PACKAGE CHARACTERISTICS

Table 10.

Parameter	Symbol	Min	Typ	Max	Unit	Test Conditions/Comments
Resistance (Input to Output) ¹	R _{I-O}		10 ¹³		Ω	
Capacitance (Input to Output) ¹	C _{I-O}		2		pF	f = 1 MHz
Input Capacitance ²	C _I		4.0		pF	
IC Junction to Ambient Thermal Resistance	θ _{JA}		80		°C/W	Thermocouple located at center of package underside

¹ The ADuM210N is considered a 2-terminal device: Pin 1 through Pin 4 are shorted together, and Pin 5 through Pin 8 are shorted together.

² Input capacitance is from any input data pin to ground.

REGULATORY INFORMATION

See Table 15 and the Insulation Lifetime section for details regarding recommended maximum working voltages for specific cross-isolation waveforms and insulation levels.

Table 11.

UL (Pending)	CSA (Pending)	VDE (Pending)	CQC (Pending)
Recognized Under 1577 Component Recognition Program ¹	Approved under CSA Component Acceptance Notice 5A	Certified according to DIN V VDE V 0884-10 (VDE V 0884-10):2006-12 ²	Certified by CQC11-471543-2012
Single Protection, 5000 V rms Isolation Voltage	CSA 60950-1-07+A1+A2 and IEC 60950-1, Second Edition, +A1+A2 Basic insulation at 800 V rms (1131 V peak)	Basic insulation, 849 V peak, V _{IOSM} = 16,000 V peak	GB4943.1-2011
Double Protection, 5000 V rms Isolation Voltage	Reinforced insulation at 400 V rms (565 V peak) IEC 60601-1 Edition 3.1 Basic insulation (1MOPP), 500 V rms (707 V peak) Reinforced insulation (2MOPP), 250 V rms (1414 V peak) CSA 61010-1-12 and IEC 61010-1 Third Edition Basic insulation at: 300 V rms mains, 800 V secondary (1089 V peak) Reinforced insulation at: 300 V rms mains, 400 V secondary (565 V peak)	Reinforced insulation, 849 V peak, V _{IOSM} = 10,000 V peak	Basic insulation at 800 V rms (1131 V peak) Reinforced insulation at 400 V rms (565 V peak)
File E214100	File 205078	File 2471900-4880-0001	File (pending)

¹ In accordance with UL 1577, each ADuM210N is proof tested by applying an insulation test voltage ≥ 4500 V rms for 1 sec.

² In accordance with DIN V VDE V 0884-10, each ADuM210N is proof tested by applying an insulation test voltage ≥ 1592 V peak for 1 sec (partial discharge detection limit = 5 pC). The * marking branded on the component designates DIN V VDE V 0884-10 approval.

DIN V VDE V 0884-10 (VDE V 0884-10) INSULATION CHARACTERISTICS

This isolator is suitable for reinforced electrical isolation only within the safety limit data. Protective circuits ensure the maintenance of the safety data. The * marking on packages denotes DIN V VDE V 0884-10 approval.

Table 12.

Description	Test Conditions/Comments	Symbol	Characteristic	Unit
Installation Classification per DIN VDE 0110 For Rated Mains Voltage ≤ 150 V rms For Rated Mains Voltage ≤ 300 V rms For Rated Mains Voltage ≤ 400 V rms			I to IV I to III I to III	
Climatic Classification			40/105/21	
Pollution Degree per DIN VDE 0110, Table 1			2	
Maximum Working Insulation Voltage		V_{IORM}	849	V peak
Input to Output Test Voltage, Method B1	$V_{IORM} \times 1.875 = V_{pd(m)}$, 100% production test, $t_{ini} = t_m = 1$ sec, partial discharge < 5 pC	$V_{pd(m)}$	1592	V peak
Input to Output Test Voltage, Method A After Environmental Tests Subgroup 1	$V_{IORM} \times 1.5 = V_{pd(m)}$, $t_{ini} = 60$ sec, $t_m = 10$ sec, partial discharge < 5 pC	$V_{pd(m)}$	1274	V peak
After Input and/or Safety Test Subgroup 2 and Subgroup 3	$V_{IORM} \times 1.2 = V_{pd(m)}$, $t_{ini} = 60$ sec, $t_m = 10$ sec, partial discharge < 5 pC		1019	V peak
Highest Allowable Overvoltage		V_{IOTM}	7000	V peak
Surge Isolation Voltage		V_{IOSM}		
Basic	V peak = 16.0 kV, 1.2 μs rise time, 50 μs, 50% fall time		16,000	V peak
Reinforced	V peak = 16.0 kV, 1.2 μs rise time, 50 μs, 50% fall time		10,000	V peak
Safety Limiting Values	Maximum value allowed in the event of a failure (see Figure 2)			
Maximum Junction Temperature		T_S	150	°C
Total Power Dissipation at 25°C		P_S	0.98	W
Insulation Resistance at T_S	$V_{IO} = 500$ V	R_S	>10 ⁹	Ω

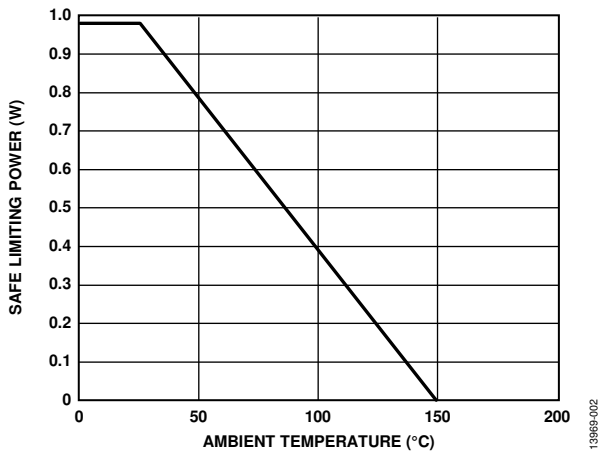

Figure 2. Thermal Derating Curve, Dependence of Safety Limiting Values with Ambient Temperature per DIN V VDE V 0884-10

RECOMMENDED OPERATING CONDITIONS

Table 13.

Parameter	Symbol	Rating
Operating Temperature	T_A	-40°C to +125°C
Supply Voltages	V_{DD1}, V_{DD2}	1.7 V to 5.5 V
Input Signal Rise and Fall Times		1.0 ms

ABSOLUTE MAXIMUM RATINGS

$T_A = 25^\circ\text{C}$, unless otherwise noted.

Table 14.

Parameter	Rating
Storage Temperature (T_{ST}) Range	-65°C to $+150^\circ\text{C}$
Ambient Operating Temperature (T_A) Range	-40°C to $+125^\circ\text{C}$
Supply Voltages (V_{DD1} , V_{DD2})	-0.5 V to $+7.0\text{ V}$
Input Voltage (V_i)	-0.5 V to $V_{DD1} + 0.5\text{ V}$
Output Voltage (V_o)	-0.5 V to $V_{DDO} + 0.5\text{ V}$
Average Output Current per Pin ³ Side 2 Output Current (I_{O2})	-10 mA to $+10\text{ mA}$
Common-Mode Transients ⁴	$-150\text{ kV}/\mu\text{s}$ to $+150\text{ kV}/\mu\text{s}$

¹ V_{DD1} is the input side supply voltage.

² V_{DDO} is the output side supply voltage.

³ See Figure 2 for the maximum rated current values for various temperatures.

⁴ Common-mode transients refers to the common-mode transients across the insulation barrier. Common-mode transients exceeding the absolute maximum ratings may cause latch-up or permanent damage.

Stresses at or above those listed under Absolute Maximum Ratings may cause permanent damage to the product. This is a stress rating only; functional operation of the product at these or any other conditions above those indicated in the operational section of this specification is not implied. Operation beyond the maximum operating conditions for extended periods may affect product reliability.

ESD CAUTION



ESD (electrostatic discharge) sensitive device. Charged devices and circuit boards can discharge without detection. Although this product features patented or proprietary protection circuitry, damage may occur on devices subjected to high energy ESD. Therefore, proper ESD precautions should be taken to avoid performance degradation or loss of functionality.

Table 15. Maximum Continuous Working Voltage¹

Parameter	Rating	Constraint
AC Voltage		
Bipolar Waveform		
Basic Insulation	849 V peak	50-year minimum insulation lifetime
Reinforced Insulation	789 V peak	Lifetime limited by package creepage maximum approved working voltage per IEC 60950-1 ²
Unipolar Waveform		
Basic Insulation	1698 V peak	50-year minimum insulation lifetime
Reinforced Insulation	849 V peak	50-year minimum insulation lifetime
DC Voltage		
Basic Insulation	1118 V peak	Lifetime limited by package creepage maximum approved working voltage per IEC 60950-1 ²
Reinforced Insulation	558 V peak	Lifetime limited by package creepage maximum approved working voltage per IEC 60950-1 ²

¹ Maximum continuous working voltage refers to the continuous voltage magnitude imposed across the isolation barrier. See the Insulation Lifetime section for more details.

² Insulation lifetime for the specified test condition is greater than 50 years.

Truth Table

Table 16. Truth Table (Positive Logic)

V_i Input ¹	V_{DD1} State	V_{DD2} State	Default Low (N0), V_o Output ²	Default High (N1), V_o Output ²	Test Conditions/ Comments
Low	Powered	Powered	Low	Low	Normal operation
High	Powered	Powered	High	High	Normal operation
X ³	Unpowered	Powered	Low	High	Fail-safe output
X ³	Powered	Unpowered	Indeterminate	Indeterminate	

¹ X means don't care.

² N0 indicates the ADuM210N0 models and N1 indicates the ADuM210N1 models. See the Ordering Guide.

³ Input pins (V_i) on the same side as an unpowered supply must be in a low state to avoid powering the device through its ESD protection circuitry.

PIN CONFIGURATION AND FUNCTION DESCRIPTIONS

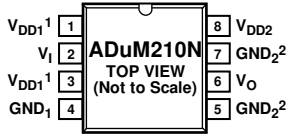

¹ PIN 1 AND PIN 3 ARE INTERNALLY CONNECTED. EITHER OR BOTH MAY BE USED FOR V_{DD1} .
² PIN 5 AND PIN 7 ARE INTERNALLY CONNECTED. EITHER OR BOTH MAY BE USED FOR GND_2 .

13865-004

Figure 3. Pin Configuration

Table 17. Pin Function Descriptions¹

Pin No.	Mnemonic	Description
1	V_{DD1}	Supply Voltage for Isolator Side 1. Pin 1 and Pin 3 are internally connected. Either or both may be used for V_{DD1} .
2	V_I	Logic Input.
3	V_{DD1}	Supply Voltage for Isolator Side 1. Pin 1 and Pin 3 are internally connected. Either or both may be used for V_{DD1} .
4	GND_1	Ground 1. Ground reference for Isolator Side 1.
5	GND_2	Ground 2. Ground reference for Isolator Side 2. Pin 5 and Pin 7 are internally connected. Either or both may be used for GND_2 .
6	V_O	Logic Output.
7	GND_2	Ground 2. Ground reference for Isolator Side 2. Pin 5 and Pin 7 are internally connected. Either or both may be used for GND_2 .
8	V_{DD2}	Supply Voltage for Isolator Side 2.

¹ Reference the [AN-1109 Application Note](#) for specific layout guidelines.

TYPICAL PERFORMANCE CHARACTERISTICS

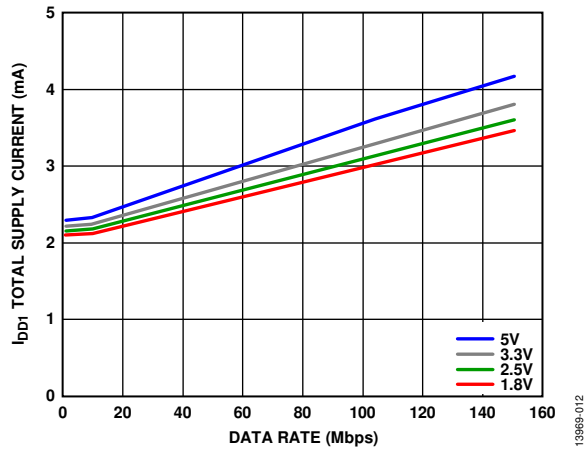

Figure 4. I_{DD1} Total Supply Current vs. Data Rate at Various Voltages

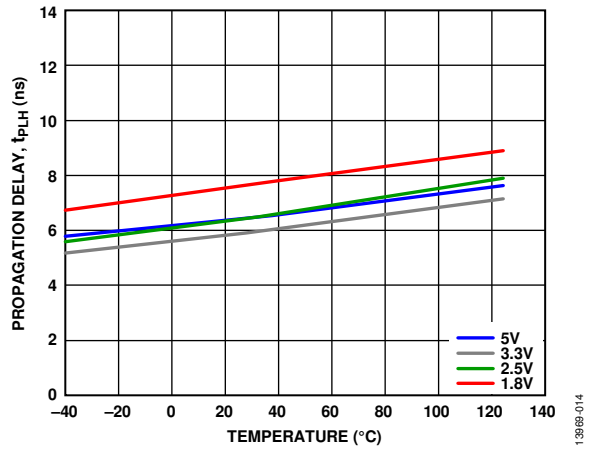

Figure 6. Propagation Delay, t_{PLH} vs. Temperature at Various Voltages

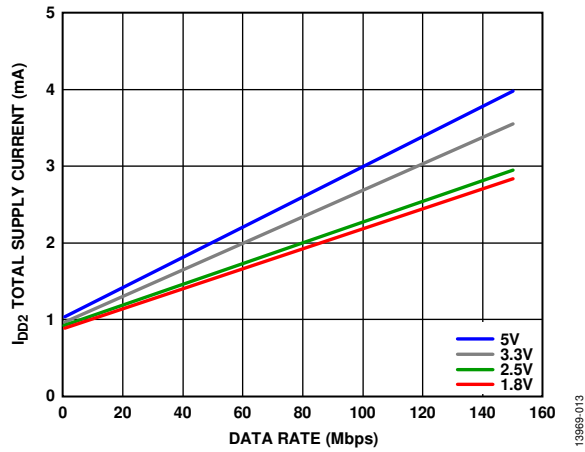

Figure 5. I_{DD2} Total Supply Current vs. Data Rate at Various Voltages

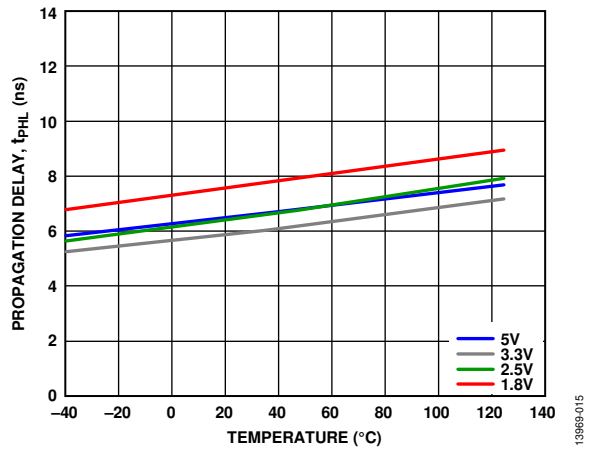

Figure 7. Propagation Delay, t_{PHL} vs. Temperature at Various Voltages

APPLICATIONS INFORMATION

OVERVIEW

The ADuM210N uses a high frequency carrier to transmit data across the isolation barrier using *i*Coupler chip scale transformer coils separated by layers of polyimide isolation. With an on/off keying (OOK) technique and the differential architecture shown in Figure 9 and Figure 10, the ADuM210N has very low propagation delay and high speed. Internal regulators and input/output design techniques allow logic and supply voltages over a wide range from 1.7 V to 5.5 V, offering voltage translation of 1.8 V, 2.5 V, 3.3 V, and 5 V logic. The architecture is designed for high common-mode transient immunity and high immunity to electrical noise and magnetic interference. Radiated emissions are minimized with a spread spectrum OOK carrier and other techniques.

Figure 9 shows the waveforms for the ADuM210N0 models, which have the condition of the fail-safe output state equal to low, where the carrier waveform is off when the input state is low. If the input side is off or not operating, the fail-safe output state of low (noted by a 0 in the model number) sets the output to low. For the ADuM210N1 models, which have a fail-safe output state of high, Figure 10 shows the conditions where the carrier waveform is off when the input state is high. When the input side is off or not operating, the fail-safe output state of high (noted by a 1 in the model number) sets the output to high. See the Ordering Guide for the model numbers that have the fail-safe output state of low or the fail-safe output state of high.

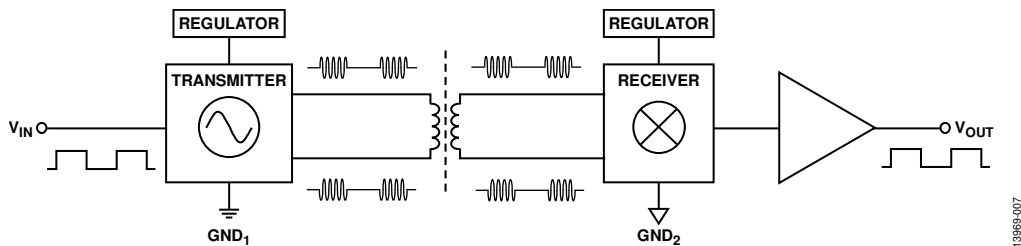

Figure 9. Operational Block Diagram of a Single Channel with a Low Fail-Safe Output State

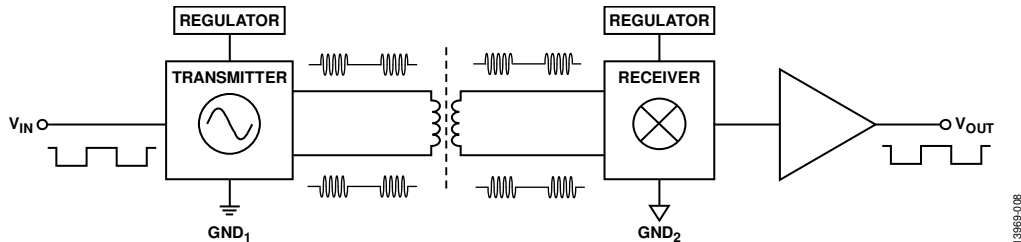

Figure 10. Operational Block Diagram of a Single Channel with a High Fail-Safe Output State

PCB LAYOUT

The ADuM210N digital isolator requires no external interface circuitry for the logic interfaces. Power supply bypassing is strongly recommended at the input and output supply pins (see Figure 8). Bypass capacitors are most conveniently connected between Pin 1 and Pin 4 for V_{DD1} and between Pin 5 and Pin 8 for V_{DD2} . The recommended bypass capacitor value is between 0.01 μ F and 0.1 μ F. The total lead length between both ends of the capacitor and the input power supply pin must not exceed 10 mm.

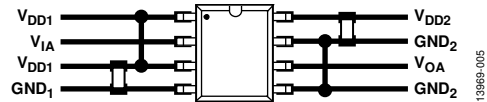

Figure 8. Recommended Printed Circuit Board Layout

In applications involving high common-mode transients, ensure that board coupling across the isolation barrier is minimized. Furthermore, design the board layout such that any coupling that does occur equally affects all pins on a given component side. Failure to ensure this can cause voltage differentials between pins exceeding the Absolute Maximum Ratings of the device, thereby leading to latch-up or permanent damage.

See the AN-1109 Application Note for PCB layout guidelines.

PROPAGATION DELAY RELATED PARAMETERS

Propagation delay is a parameter that describes the time it takes a logic signal to propagate through a component. The propagation delay to a Logic 0 output may differ from the propagation delay to a Logic 1 output.

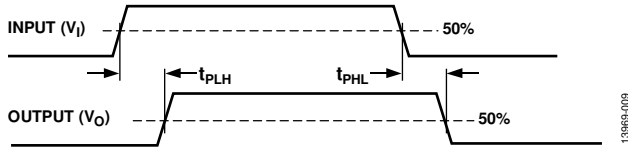

Figure 11. Propagation Delay Parameters

Pulse width distortion is the maximum difference between these two propagation delay values and is an indication of how accurately the timing of the input signal is preserved.

Propagation delay skew is the maximum amount the propagation delay differs between multiple ADuM210N components operating under the same conditions.

JITTER MEASUREMENT

Figure 12 shows the eye diagram for the ADuM210N. The measurement was taken using an Agilent 81110A pulse pattern generator at 150 Mbps with pseudorandom bit sequences (PRBS) $2(n - 1)$, $n = 14$, for 5 V supplies. Jitter was measured with the Tektronix Model 5104B oscilloscope, 1 GHz, 10 GS/sec with the DPOJET jitter and eye diagram analysis tools. The result shows a typical measurement on the ADuM210N with 380 ps p-p jitter.

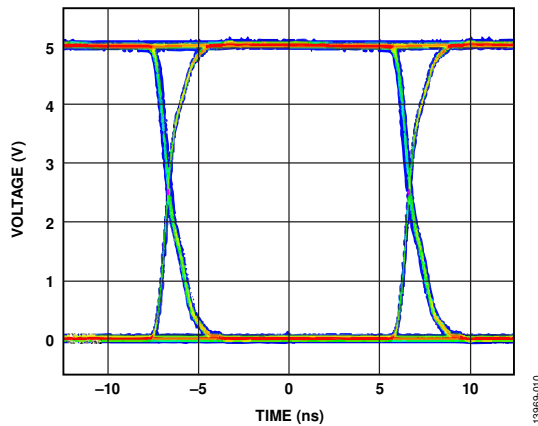

Figure 12. Eye Diagram

INSULATION LIFETIME

All insulation structures eventually break down when subjected to voltage stress over a sufficiently long period. The rate of insulation degradation is dependent on the characteristics of the voltage waveform applied across the insulation as well as on the materials and material interfaces.

The two types of insulation degradation of primary interest are breakdown along surfaces exposed to the air and insulation wear out. Surface breakdown is the phenomenon of surface tracking, and the primary determinant of surface creepage requirements in system level standards. Insulation wear out is the phenomenon where charge injection or displacement currents inside the insulation material cause long-term insulation degradation.

Surface Tracking

Surface tracking is addressed in electrical safety standards by setting a minimum surface creepage based on the working voltage, the environmental conditions, and the properties of the insulation material. Safety agencies perform characterization testing on the surface insulation of components that allows the components to be categorized in different material groups. Lower material group ratings are more resistant to surface tracking and, therefore, can provide adequate lifetime with smaller creepage. The minimum creepage for a given working voltage and material group is in each system level standard and is based on the total rms voltage across the isolation, pollution degree, and material group. The material group and creepage for the ADuM210N isolators are presented in Table 9.

Insulation Wear Out

The lifetime of insulation caused by wear out is determined by its thickness, material properties, and the voltage stress applied. It is important to verify that the product lifetime is adequate at the application working voltage. The working voltage supported by an isolator for wear out may not be the same as the working voltage supported for tracking. It is the working voltage applicable to tracking that is specified in most standards.

Testing and modeling show that the primary driver of long-term degradation is displacement current in the polyimide insulation causing incremental damage. The stress on the insulation can be broken down into broad categories, such as dc stress, which causes very little wear out because there is no displacement current, and an ac component time varying voltage stress, which causes wear out.

The ratings in certification documents are usually based on 60 Hz sinusoidal stress because this reflects isolation from line voltage. However, many practical applications have combinations of 60 Hz ac and dc across the barrier as shown in Equation 1. Because only the ac portion of the stress causes wear out, the equation can be rearranged to solve for the ac rms voltage, as is shown in Equation 2. For insulation wear out with the polyimide materials used in these products, the ac rms voltage determines the product lifetime.

$$V_{RMS} = \sqrt{V_{AC\ RMS}^2 + V_{DC}^2} \tag{1}$$

or

$$V_{AC\ RMS} = \sqrt{V_{RMS}^2 - V_{DC}^2} \tag{2}$$

where:

V_{RMS} is the total rms working voltage.

$V_{AC\ RMS}$ is the time varying portion of the working voltage.

V_{DC} is the dc offset of the working voltage.

Calculation and Use of Parameters Example

The following example frequently arises in power conversion applications. Assume that the line voltage on one side of the isolation is 240 V_{AC RMS} and a 400 V_{DC} bus voltage is present on the other side of the isolation barrier. The isolator material is polyimide. To establish the critical voltages in determining the creepage, clearance and lifetime of a device, see Figure 13 and the following equations.

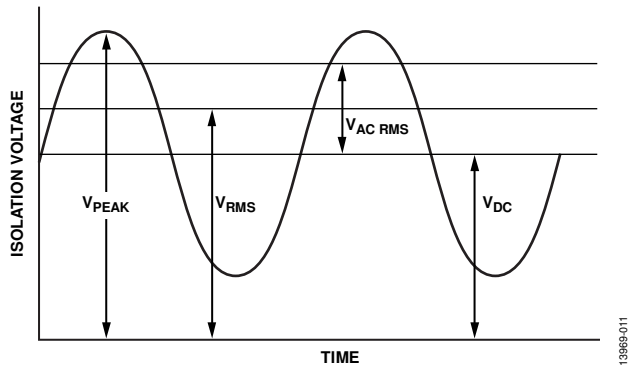

Figure 13. Critical Voltage Example

The working voltage across the barrier from Equation 1 is

$$V_{RMS} = \sqrt{V_{AC\ RMS}^2 + V_{DC}^2}$$

$$V_{RMS} = \sqrt{240^2 + 400^2}$$

$$V_{RMS} = 466\ V$$

This is the working voltage used together with the material group and pollution degree when looking up the creepage required by a system standard.

To determine if the lifetime is adequate, obtain the time varying portion of the working voltage. To obtain the ac rms voltage, use Equation 2.

$$V_{AC\ RMS} = \sqrt{V_{RMS}^2 - V_{DC}^2}$$

$$V_{AC\ RMS} = \sqrt{466^2 - 400^2}$$

$$V_{AC\ RMS} = 240\ V\ rms$$

In this case, the ac rms voltage is simply the line voltage of 240 V rms. This calculation is more relevant when the waveform is not sinusoidal. The value is compared to the limits for working voltage in Table 15 for the expected lifetime, less than a 60 Hz sine wave, and it is well within the limit for a 50-year service life.

Note that the dc working voltage limit in Table 15 is set by the creepage of the package as specified in IEC 60664-1. This value can differ for specific system level standards.

OUTLINE DIMENSIONS

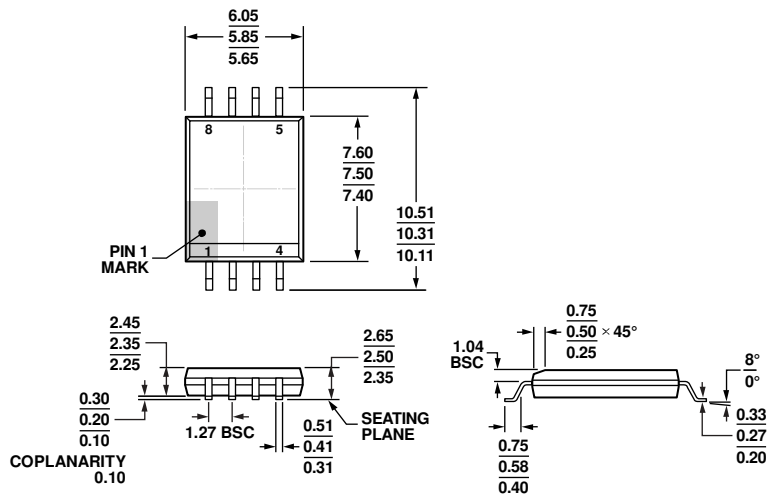

06-17-2014-B

Figure 14. 8-Lead Standard Small Outline Package, with Increased Creepage [SOIC_IC] Wide Body (RI-8-1)
Dimensions shown in millimeters

ORDERING GUIDE

Model ¹	Temperature Range	No. of Inputs, V _{DD1} Side	No. of Inputs, V _{DD2} Side	Withstand Voltage Rating (kV rms)	Fail-Safe Output State	Package Description	Package Option
ADuM210N1BRIZ	-40°C to +125°C	1	0	5.0	High	8-Lead SOIC_IC	RI-8-1
ADuM210N1BRIZ-RL	-40°C to +125°C	1	0	5.0	High	8-Lead SOIC_IC	RI-8-1
ADuM210N0BRIZ	-40°C to +125°C	1	0	5.0	Low	8-Lead SOIC_IC	RI-8-1
ADuM210N0BRIZ-RL	-40°C to +125°C	1	0	5.0	Low	8-Lead SOIC_IC	RI-8-1

¹ Z = RoHS Compliant Part.