



Chipsmall Limited consists of a professional team with an average of over 10 year of expertise in the distribution of electronic components. Based in Hongkong, we have already established firm and mutual-benefit business relationships with customers from,Europe,America and south Asia,supplying obsolete and hard-to-find components to meet their specific needs.

With the principle of “Quality Parts,Customers Priority,Honest Operation,and Considerate Service”,our business mainly focus on the distribution of electronic components. Line cards we deal with include Microchip,ALPS,ROHM,Xilinx,Pulse,ON,Everlight and Freescale. Main products comprise IC,Modules,Potentiometer,IC Socket,Relay,Connector.Our parts cover such applications as commercial,industrial, and automotives areas.

We are looking forward to setting up business relationship with you and hope to provide you with the best service and solution. Let us make a better world for our industry!



Contact us

Tel: +86-755-8981 8866 Fax: +86-755-8427 6832

Email & Skype: info@chipsmall.com Web: www.chipsmall.com

Address: A1208, Overseas Decoration Building, #122 Zhenhua RD., Futian, Shenzhen, China



FEATURES

- isoPower* integrated, isolated dc-to-dc converter
- Qualified for automotive applications
- Regulated 5 V or 3.3 V output
- Up to 500 mW output power
- Quad dc-to-25 Mbps (NRZ) signal isolation channels
- 16-lead SOIC package with 7.6 mm creepage
- High temperature operation: 105°C
- High common-mode transient immunity: >25 kV/μs
- Safety and regulatory approvals**
 - UL recognition: 2500 V rms for 1 minute per UL 1577
 - CSA Component Acceptance Notice #5A
 - VDE certificate of conformity
 - DIN EN 69747-5-2 (VDE 0884 Teil 2):2003-1
 - $V_{IORM} = 565$ V peak

APPLICATIONS

Hybrid electric battery management

GENERAL DESCRIPTION

The ADuM5401W/ADuM5402W/ADuM5403W¹ devices are quad-channel digital isolators with *isoPower*®, an integrated, isolated dc-to-dc converter. Based on the Analog Devices, Inc., *iCoupler*® technology, the dc-to-dc converter provides up to 500 mW of regulated, isolated power at 5.0 V (see Table 1). These devices eliminate the need for a separate, isolated dc-to-dc converter in low power, isolated designs. The *iCoupler* chip scale transformer technology is used to isolate the logic signals and for the magnetic components of the dc-to-dc converter. The result is a small form factor, total isolation solution.

The ADuM5401W-1/ADuM5402W-1/ADuM5403W-1 versions of the isolators provide an upgraded voltage reference to ensure proper startup under all load conditions (see the Ordering Guide for more information).

isoPower uses high frequency switching elements to transfer power through its transformer. Special care must be taken during printed circuit board (PCB) layout to meet emissions standards. See the AN-0971 Application Note for board layout recommendations.

FUNCTIONAL BLOCK DIAGRAMS

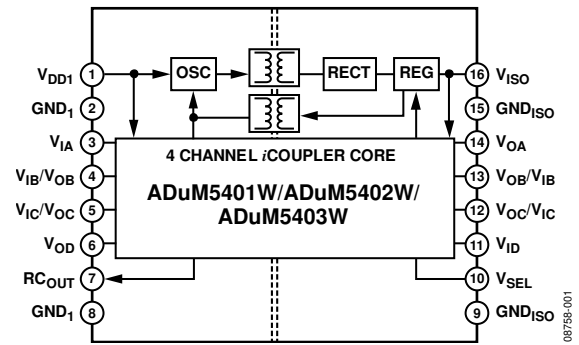

Figure 1. ADuM5401W/ADuM5402W/ADuM5403W Block Diagram

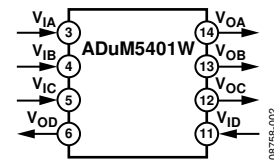

Figure 2. ADuM5401W

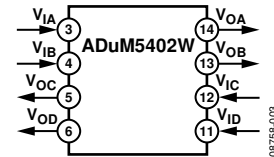

Figure 3. ADuM5402W

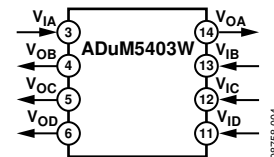

Figure 4. ADuM5403W

Table 1. Power Levels

Input Voltage (V)	Output Voltage (V)	Output Power (mW)
5.0	5.0	500
5.0	3.3	330
3.3	3.3	200

¹ Protected by U.S. Patents 5,952,849; 6,873,065; 6,903,578; and 7,075,329. Other patents are pending.

TABLE OF CONTENTS

Features	1
Applications.....	1
General Description	1
Functional Block Diagrams.....	1
Revision History	2
Specifications.....	3
Electrical Characteristics—5 V Primary Input Supply/5 V Secondary Isolated Supply.....	3
Electrical Characteristics—3.3 V Primary Input Supply/3.3 V Secondary Isolated Supply.....	5
Electrical Characteristics—5 V Primary Input Supply/3.3 V Secondary Isolated Supply.....	7
Package Characteristics	9
Regulatory Approvals.....	9
Insulation and Safety-Related Specifications	9
DIN EN 69747-5-2 (VDE 0884 Teil 2) Insulation Characteristics	10
Recommended Operating Conditions	10
Absolute Maximum Ratings.....	11
ESD Caution.....	11

REVISION HISTORY

8/14—Rev. D to Rev. E

Changes to Table 6 Conditions	5
-------------------------------------	---

4/13—Rev. C to Rev. D

Added Figure 17 and Figure 18; Renumbered Sequentially	16
Added Start-Up Behavior Section	20
Change to DC Correctness and Magnetic Field Immunity Section.....	20
Changes to Ordering Guide	24

11/12—Rev. B to Rev. C

Changes to Ordering Guide	23
---------------------------------	----

6/12—Rev. A to Rev. B

Created Hyperlink for Safety and Regulatory Approvals Entry in Features Section.....	1
Added Table 1; Renumbered Sequentially	1
Changes to Table 2, Table 3, and Table 4	3
Changes to Endnote 3 in Table 5	4
Change to Table 6	5
Changes to Table 9.....	6
Change to Table 10	7
Changes to Table 13.....	8
Change to Table 16	9
Change to Table 18	10
Changes to Table 21.....	12

Pin Configurations and Function Descriptions	12
Truth Table	14
Typical Performance Characteristics	15
Terminology	18
Applications Information	19
Theory of Operation	19
PCB Layout	19
Thermal Analysis	19
Propagation Delay Related Parameters	20
Start-Up Behavior.....	20
EMI Considerations	20
DC Correctness and Magnetic Field Immunity.....	20
Power Consumption	21
Power Considerations.....	22
Insulation Lifetime	22
V _{ISO} Start-Up Issues.....	23
Outline Dimensions	24
Ordering Guide	24
Automotive Products.....	24

Changes to Table 22	13
Changes to Table 23 and Table 24	14
Changes to Theory of Operation Section.....	18
Changes to EMI Considerations Section	19

4/12—Rev. 0 to Rev. A

Changes to General Description and Features Sections	1
Changed DIN V VDE 0884-10 (VDE V 0884-10):2006-12 to DIN EN 69747-5-2 (VDE 0884 Teil 2):2003-1 Throughout.....	1
Added Electrical Characteristics—3.3 V Primary Input Supply/3.3 V Secondary Isolated Supply Section.....	5
Added Table 5, Table 6, and Table 7; Renumbered Sequentially....	5
Added Table 8	6
Added Electrical Characteristics—5 V Primary Input Supply/ 3.3 V Secondary Isolated Supply Section	7
Added Table 9, Table 10, and Table 11.....	7
Added Table 12	8
Changes to Table 14 and Table 15	9
Changes to Table 16	10
Changes to Typical Performance Characteristics Section	16
Changes to V _{ISO} Start-Up Issues Section	23
Changes to Ordering Guide	24
Added Automotive Products Section	24

1/10—Revision 0: Initial Version

SPECIFICATIONS

ELECTRICAL CHARACTERISTICS—5 V PRIMARY INPUT SUPPLY/5 V SECONDARY ISOLATED SUPPLY

Typical specifications are at $T_A = 25^\circ\text{C}$, $V_{DD1} = V_{SEL} = V_{ISO} = 5\text{ V}$. Minimum/maximum specifications apply over the entire recommended operation range, which is $4.5\text{ V} \leq V_{DD1}, V_{SEL}, V_{ISO} \leq 5.5\text{ V}$, and $-40^\circ\text{C} \leq T_A \leq +105^\circ\text{C}$, unless otherwise noted. Switching specifications are tested with $C_L = 15\text{ pF}$ and CMOS signal levels, unless otherwise noted.

Table 2. DC-to-DC Converter Static Specifications

Parameter	Symbol	Min	Typ	Max	Unit	Test Conditions/Comments
DC-TO-DC CONVERTER SUPPLY						
Setpoint	V_{ISO}	4.7	5.0	5.4	V	$I_{ISO} = 0\text{ mA}$
Line Regulation	$V_{ISO (LINE)}$		1		mV/V	$I_{ISO} = 50\text{ mA}$, $V_{DD1} = 4.5\text{ V to }5.5\text{ V}$
Load Regulation	$V_{ISO (LOAD)}$		1	5	%	$I_{ISO} = 10\text{ mA to }90\text{ mA}$
Output Ripple	$V_{ISO (RIP)}$		75		mV p-p	20 MHz bandwidth, $C_{BO} = 0.1\text{ }\mu\text{F} 10\text{ }\mu\text{F}$, $I_{ISO} = 90\text{ mA}$
Output Noise	$V_{ISO (NOISE)}$		200		mV p-p	$C_{BO} = 0.1\text{ }\mu\text{F} 10\text{ }\mu\text{F}$, $I_{ISO} = 90\text{ mA}$
Switching Frequency	f_{OSC}		180		MHz	
PWM Frequency	f_{PWM}		625		kHz	
Output Supply Current	$I_{ISO (MAX)}$	100			mA	$V_{ISO} > 4.5\text{ V}$
Efficiency at $I_{ISO (MAX)}$			34		%	$I_{ISO} = 100\text{ mA}$
I_{DD1} , No V_{ISO} Load	$I_{DD1 (Q)}$		20	35	mA	
I_{DD1} , Full V_{ISO} Load	$I_{DD1 (MAX)}$		290		mA	

Table 3. DC-to-DC Converter Dynamic Specifications

Parameter	Symbol	25 Mbps—C Grade			Unit	Test Conditions/Comments
		Min	Typ	Max		
SUPPLY CURRENT						
Input	I_{DD1}					
ADuM5401W			68		mA	No V_{ISO} load
ADuM5402W			71		mA	No V_{ISO} load
ADuM5403W			75		mA	No V_{ISO} load
Available to Load	$I_{ISO (LOAD)}$					
ADuM5401W			87		mA	
ADuM5402W			85		mA	
ADuM5403W			83		mA	

Table 4. Switching Specifications

Parameter	Symbol	Min	Typ	Max	Unit	Test Conditions/Comments
SWITCHING SPECIFICATIONS						
Data Rate				25	Mbps	Within PWD limit
Propagation Delay	t_{PHL}, t_{PLH}		45	60	ns	50% input to 50% output
Pulse Width Distortion	PWD			6	ns	$ t_{PLH} - t_{PHL} $
Change vs. Temperature			5		ps/ $^\circ\text{C}$	
Pulse Width	PW	40			ns	Within PWD limit
Propagation Delay Skew	t_{PSK}			15	ns	Between any two units
Channel Matching						
Codirectional ¹	t_{PSKCD}			6	ns	
Opposing Directional ²	t_{PSKOD}			15	ns	

¹ Codirectional channel matching is the absolute value of the difference in propagation delays between any two channels with inputs on the same side of the isolation barrier.

² Opposing directional channel matching is the absolute value of the difference in propagation delays between any two channels with inputs on opposing sides of the isolation barrier.

Table 5. Input and Output Characteristics

Parameter	Symbol	Min	Typ	Max	Unit	Test Conditions/Comments
DC SPECIFICATIONS						
Logic High Input Threshold ¹	V _{IH}	0.7 × V _{ISO} or 0.7 × V _{DD1}			V	
Logic Low Input Threshold ¹	V _{IL}			0.3 × V _{ISO} or 0.3 × V _{DD1}	V	
Logic High Output Voltages ²	V _{OH}	V _{DD1} – 0.3 or V _{ISO} – 0.3	5.0		V	I _{ox} = –20 μA, V _{Ix} = V _{IxH}
		V _{DD1} – 0.5 or V _{ISO} – 0.5	4.8		V	I _{ox} = –4 mA, V _{Ix} = V _{IxH}
Logic Low Output Voltages ²	V _{OL}		0.0	0.1	V	I _{ox} = 20 μA, V _{Ix} = V _{IxL}
			0.2	0.4	V	I _{ox} = 4 mA, V _{Ix} = V _{IxL}
Undervoltage Lockout	UVLO				V	V _{DD1} , V _{ISO} supplies
Positive Going Threshold	V _{UV+}		2.7		V	
Negative Going Threshold	V _{UV–}		2.4		V	
Hysteresis	V _{UVH}		0.3		V	
Input Currents Per Channel	I _I	–20	+0.01	+20	μA	0 V ≤ V _{Ix} ≤ V _{DD1} or V _{ISO}
AC SPECIFICATIONS						
Output Rise/Fall Time	t _R /t _F		2.5		ns	10% to 90%
Common-Mode Transient Immunity ³	CM	25	35		kV/μs	V _{Ix} = V _{DD1} or V _{ISO} , V _{CM} = 1000 V, transient magnitude = 800 V
Refresh Rate	f _r		1.0		Mbps	

¹ V_{SEL} is a nonstandard input that has a logic threshold of approximately 0.9 V.

² R_{COUT} is a nonstandard output intended to interface with other *isoPower* parts. It is not recommended for standard digital loads.

³ |CM| is the maximum common-mode voltage slew rate that can be sustained while maintaining V_O > 0.7 × V_{DD1} or 0.7 × V_{ISO} for a high output or V_O < 0.3 × V_{DD1} or 0.3 × V_{ISO} for a low output. The common-mode voltage slew rates apply to both rising and falling common-mode voltage edges.

ELECTRICAL CHARACTERISTICS—3.3 V PRIMARY INPUT SUPPLY/3.3 V SECONDARY ISOLATED SUPPLY

Typical specifications are at $T_A = 25^\circ\text{C}$, $V_{DD1} = V_{ISO} = 3.3\text{ V}$, $V_{SEL} = \text{GND}_{ISO}$. Minimum/maximum specifications apply over the entire recommended operation range, which is $3.0\text{ V} \leq V_{DD1}$, $V_{ISO} \leq 3.6\text{ V}$, and $-40^\circ\text{C} \leq T_A \leq +105^\circ\text{C}$, unless otherwise noted. Switching specifications are tested with $C_L = 15\text{ pF}$ and CMOS signal levels, unless otherwise noted.

Table 6. DC-to-DC Converter Static Specifications

Parameter	Symbol	Min	Typ	Max	Unit	Test Conditions/Comments
DC-TO-DC CONVERTER SUPPLY						
Setpoint	V_{ISO}	3.0	3.3	3.6	V	$I_{ISO} = 0\text{ mA}$
Line Regulation	$V_{ISO(LINE)}$		1		mV/V	$I_{ISO} = 30\text{ mA}$, $V_{DD1} = 3.0\text{ V to } 3.6\text{ V}$
Load Regulation	$V_{ISO(LOAD)}$		1	5	%	$I_{ISO} = 6\text{ mA to } 54\text{ mA}$
Output Ripple	$V_{ISO(RIP)}$		50		mV p-p	20 MHz bandwidth, $C_{BO} = 0.1\text{ }\mu\text{F} 10\text{ }\mu\text{F}$, $I_{ISO} = 54\text{ mA}$
Output Noise	$V_{ISO(NOISE)}$		130		mV p-p	$C_{BO} = 0.1\text{ }\mu\text{F} 10\text{ }\mu\text{F}$, $I_{ISO} = 54\text{ mA}$
Switching Frequency	f_{OSC}		180		MHz	
PWM Frequency	f_{PWM}		625		kHz	
Output Supply Current	$I_{ISO(MAX)}$	60			mA	$V_{ISO} > 3\text{ V}$
Efficiency at $I_{ISO(MAX)}$			33		%	$I_{ISO} = 60\text{ mA}$
I_{DD1} , No V_{ISO} Load	$I_{DD1(Q)}$		14	22	mA	
I_{DD1} , Full V_{ISO} Load	$I_{DD1(MAX)}$		175		mA	

Table 7. DC-to-DC Converter Dynamic Specifications

Parameter	Symbol	25 Mbps—C Grade			Unit	Test Conditions/Comments
		Min	Typ	Max		
SUPPLY CURRENT						
Input	I_{DD1}					
ADuM5401W			44		mA	No V_{ISO} load
ADuM5402W			46		mA	No V_{ISO} load
ADuM5403W			47		mA	No V_{ISO} load
Available to Load	$I_{ISO(LOAD)}$					
ADuM5401W			52		mA	
ADuM5402W			51		mA	
ADuM5403W			49		mA	

Table 8. Switching Specifications

Parameter	Symbol	Min	Typ	Max	Unit	Test Conditions/Comments
SWITCHING SPECIFICATIONS						
Data Rate				25	Mbps	Within PWD limit
Propagation Delay	t_{PHL} , t_{PLH}		45	60	ns	50% input to 50% output
Pulse Width Distortion	PWD			6	ns	$ t_{PLH} - t_{PHL} $
Change vs. Temperature			5		ps/ $^\circ\text{C}$	
Pulse Width	PW	40			ns	Within PWD limit
Propagation Delay Skew	t_{PSK}			45	ns	Between any two units
Channel Matching						
Codirectional ¹	t_{PSKCD}			6	ns	
Opposing Directional ²	t_{PSKOD}			15	ns	

¹ Codirectional channel matching is the absolute value of the difference in propagation delays between any two channels with inputs on the same side of the isolation barrier.

² Opposing directional channel matching is the absolute value of the difference in propagation delays between any two channels with inputs on opposing sides of the isolation barrier.

Table 9. Input and Output Characteristics

Parameter	Symbol	Min	Typ	Max	Unit	Test Conditions/Comments
DC SPECIFICATIONS						
Logic High Input Threshold ¹	V _{IH}	0.7 × V _{ISO} or 0.7 × V _{DD1}			V	
Logic Low Input Threshold ¹	V _{IL}			0.3 × V _{ISO} or 0.3 × V _{DD1}	V	
Logic High Output Voltages ²	V _{OH}	V _{DD1} – 0.3 or V _{ISO} – 0.3	3.3		V	I _{ox} = –20 μA, V _{ix} = V _{ixH}
		V _{DD1} – 0.5 or V _{ISO} – 0.5	3.1		V	I _{ox} = –4 mA, V _{ix} = V _{ixH}
Logic Low Output Voltages ²	V _{OL}		0.0	0.1	V	I _{ox} = 20 μA, V _{ix} = V _{ixL}
			0.0	0.4	V	I _{ox} = 4 mA, V _{ix} = V _{ixL}
Undervoltage Lockout	UVLO					V _{DD1} , V _{ISO} supplies
Positive Going Threshold	V _{UV+}		2.7		V	
Negative Going Threshold	V _{UV–}		2.4		V	
Hysteresis	V _{UVH}		0.3		V	
Input Currents per Channel	I _I	–10	+0.01	+10	μA	0 V ≤ V _{ix} ≤ V _{DD1} or V _{ISO}
AC SPECIFICATIONS						
Output Rise/Fall Time	t _R /t _F		2.5		ns	10% to 90%
Common-Mode Transient Immunity ³	CM	25	35		kV/μs	V _{ix} = V _{DD1} or V _{ISO} , V _{CM} = 1000 V, transient magnitude = 800 V
Refresh Rate	f _r		1.0		Mbps	

¹ V_{SEL} is a nonstandard input that has a logic threshold of approximately 0.9 V.

² RC_{OUT} is a nonstandard output intended to interface with other *isoPower* parts. It is not recommended for standard digital loads.

³ |CM| is the maximum common-mode voltage slew rate that can be sustained while maintaining V_O > 0.7 × V_{DD1} or 0.7 × V_{ISO} for a high output or V_O < 0.3 × V_{DD1} or 0.3 × V_{ISO} for a low output. The common-mode voltage slew rates apply to both rising and falling common-mode voltage edges.

ELECTRICAL CHARACTERISTICS—5 V PRIMARY INPUT SUPPLY/3.3 V SECONDARY ISOLATED SUPPLY

Typical specifications are at $T_A = 25^\circ\text{C}$, $V_{DD1} = 5.0\text{ V}$, $V_{ISO} = 3.3\text{ V}$, $V_{SEL} = \text{GND}_{ISO}$. Minimum/maximum specifications apply over the entire recommended operation range, which is $4.5\text{ V} \leq V_{DD1} \leq 5.5\text{ V}$, $3.0\text{ V} \leq V_{ISO} \leq 3.6\text{ V}$, and $-40^\circ\text{C} \leq T_A \leq +105^\circ\text{C}$, unless otherwise noted. Switching specifications are tested with $C_L = 15\text{ pF}$ and CMOS signal levels, unless otherwise noted.

Table 10. DC-to-DC Converter Static Specifications

Parameter	Symbol	Min	Typ	Max	Unit	Test Conditions/Comments
DC-TO-DC CONVERTER SUPPLY						
Setpoint	V_{ISO}	3.0	3.3	3.6	V	$I_{ISO} = 0\text{ mA}$
Line Regulation	$V_{ISO(LINE)}$		1		mV/V	$I_{ISO} = 50\text{ mA}$, $V_{DD1} = 3.0\text{ V to }3.6\text{ V}$
Load Regulation	$V_{ISO(LOAD)}$		1	5	%	$I_{ISO} = 6\text{ mA to }54\text{ mA}$
Output Ripple	$V_{ISO(RIP)}$		50		mV p-p	20 MHz bandwidth, $C_{BO} = 0.1\text{ }\mu\text{F} 10\text{ }\mu\text{F}$, $I_{ISO} = 90\text{ mA}$
Output Noise	$V_{ISO(NOISE)}$		130		mV p-p	$C_{BO} = 0.1\text{ }\mu\text{F} 10\text{ }\mu\text{F}$, $I_{ISO} = 90\text{ mA}$
Switching Frequency	f_{OSC}		180		MHz	
PWM Frequency	f_{PWM}		625		kHz	
Output Supply Current	$I_{ISO(MAX)}$	100			mA	$V_{ISO} > 3\text{ V}$
Efficiency at $I_{ISO(MAX)}$			30		%	$I_{ISO} = 90\text{ mA}$
I_{DD1} , No V_{ISO} Load	$I_{DD1(Q)}$		14	22	mA	
I_{DD1} , Full V_{ISO} Load	$I_{DD1(MAX)}$		230		mA	

Table 11. DC-to-DC Converter Dynamic Specifications

Parameter	Symbol	25 Mbps—C Grade			Unit	Test Conditions/Comments
		Min	Typ	Max		
SUPPLY CURRENT						
Input	I_{DD1}					
ADuM5401W			44		mA	No V_{ISO} load
ADuM5402W			45		mA	No V_{ISO} load
ADuM5403W			46		mA	No V_{ISO} load
Available to Load	$I_{ISO(LOAD)}$					
ADuM5401W			92		mA	
ADuM5402W			91		mA	
ADuM5403W			89		mA	

Table 12. Switching Specifications

Parameter	Symbol	Min	Typ	Max	Unit	Test Conditions/Comments
SWITCHING SPECIFICATIONS						
Data Rate				25	Mbps	Within PWD limit
Propagation Delay	t_{PHL} , t_{PLH}		45	60	ns	50% input to 50% output
Pulse Width Distortion	PWD			6	ns	$ t_{PLH} - t_{PHL} $
Change vs. Temperature			5		ps/ $^\circ\text{C}$	
Pulse Width	PW	40			ns	Within PWD limit
Propagation Delay Skew	t_{PSK}			15	ns	Between any two units
Channel Matching						
Codirectional ¹	t_{PSKCD}			6	ns	
Opposing Directional ²	t_{PSKOD}			15	ns	

¹ Codirectional channel matching is the absolute value of the difference in propagation delays between any two channels with inputs on the same side of the isolation barrier.

² Opposing directional channel matching is the absolute value of the difference in propagation delays between any two channels with inputs on opposing sides of the isolation barrier.

Table 13. Input and Output Characteristics

Parameter	Symbol	Min	Typ	Max	Unit	Test Conditions/Comments
DC SPECIFICATIONS						
Logic High Input Threshold ¹	V _{IH}	0.7 × V _{ISO} or 0.7 × V _{DD1}			V	
Logic Low Input Threshold ¹	V _{IL}			0.3 × V _{ISO} or 0.3 × V _{DD1}	V	
Logic High Output Voltages ²	V _{OH}	V _{DD1} – 0.2 or V _{ISO} – 0.2	V _{DD1} or V _{ISO}		V	I _{OX} = –20 μA, V _{IX} = V _{IXH}
		V _{DD1} – 0.5 or V _{ISO} – 0.5	V _{DD1} – 0.2 or V _{ISO} – 0.2		V	I _{OX} = –4 mA, V _{IX} = V _{IXH}
Logic Low Output Voltages ²	V _{OL}		0.0	0.1	V	I _{OX} = 20 μA, V _{IX} = V _{IXL}
			0.0	0.4	V	I _{OX} = 4 mA, V _{IX} = V _{IXL}
Undervoltage Lockout	UVLO					V _{DD1} , V _{ISO} supplies
Positive Going Threshold	V _{UV+}		2.7		V	
Negative Going Threshold	V _{UV–}		2.4		V	
Hysteresis	V _{UVH}		0.3		V	
Input Currents per Channel	I _I	–10	+0.01	+10	μA	0 V ≤ V _{IX} ≤ V _{DD1} or V _{ISO}
AC SPECIFICATIONS						
Output Rise/Fall Time	t _R /t _F		2.5		ns	10% to 90%
Common-Mode Transient Immunity ³	CM	25	35		kV/μs	V _{IX} = V _{DD1} or V _{ISO} , V _{CM} = 1000 V, transient magnitude = 800 V
Refresh Rate	f _r		1.0		Mbps	

¹ V_{SEL} is a nonstandard input that has a logic threshold of approximately 0.9 V.² R_{COUT} is a nonstandard output intended to interface with other *isoPower* parts. It is not recommended for standard digital loads.³ |CM| is the maximum common-mode voltage slew rate that can be sustained while maintaining V_O > 0.7 × V_{DD1} or 0.7 × V_{ISO} for a high output or V_O < 0.3 × V_{DD1} or 0.3 × V_{ISO} for a low output. The common-mode voltage slew rates apply to both rising and falling common-mode voltage edges.

PACKAGE CHARACTERISTICS**Table 14. Thermal and Isolation Characteristics**

Parameter	Symbol	Min	Typ	Max	Unit	Test Conditions/Comments
Resistance (Input to Output) ¹	R _{I-O}		10 ¹²		Ω	
Capacitance (Input to Output) ¹	C _{I-O}		2.2		pF	f = 1 MHz
Input Capacitance ²	C _i		4.0		pF	
IC Junction to Ambient Thermal Resistance	θ _{JA}		45		°C/W	Thermocouple located at center of package underside, test conducted on 4-layer board with thin traces ³

¹ The device is considered a 2-terminal device; Pin 1 to Pin 8 are shorted together, and Pin 9 to Pin 16 are shorted together.

² Input capacitance is from any input data pin to ground.

³ See the Thermal Analysis section for thermal model definitions.

REGULATORY APPROVALS**Table 15.**

UL ¹	CSA	VDE ²
Recognized under 1577 component recognition program ¹ Single protection, 2500 V rms isolation voltage File E214100	Approved under CSA Component Acceptance Notice #5A Basic insulation per CSA 60950-1-03 and IEC 60950-1, 400 V rms (566 V peak) maximum working voltage File 205078	Certified according to DIN EN 69747-5-2 (VDE 0884 Teil 2):2003-1 Reinforced insulation, 565 V peak File 2471900-4880-0001

¹ In accordance with UL 1577, each ADuM5401W/ADuM5402W/ADuM5403W is proof tested by applying an insulation test voltage ≥ 3000 V rms for 1 second (current leakage detection limit = 10 μA).

² In accordance with DIN EN 69747-5-2 (VDE 0884 Teil 2):2003-1, each ADuM5401W/ADuM5402W/ADuM5403W is proof tested by applying an insulation test voltage ≥ 1590 V peak for 1 second (partial discharge detection limit = 5 pC). The asterisk (*) marking branded on the component designates DIN EN 69747-5-2 (VDE 0884 Teil 2):2003-1 approval.

INSULATION AND SAFETY-RELATED SPECIFICATIONS**Table 16. Critical Safety-Related Dimensions and Material Properties**

Parameter	Symbol	Value	Unit	Test Conditions/Comments
Rated Dielectric Insulation Voltage		2500	V rms	1-minute duration
Minimum External Air Gap (Clearance)	L(I01)	>8.0	mm	Measured from input terminals to output terminals in the seating plane of the PCB, shortest distance through air
Minimum External Tracking (Creepage)	L(I02)	7.6	mm	Measured from input terminals to output terminals, shortest distance path along body
Minimum Internal Gap (Internal Clearance)		0.017 min	mm	Distance through insulation
Tracking Resistance (Comparative Tracking Index)	CTI	>175	V	DIN IEC 112/VDE 0303, Part 1
Isolation Group		IIIa		Material group (DIN VDE 0110, 1/89, Table 1)

DIN EN 69747-5-2 (VDE 0884 TEIL 2) INSULATION CHARACTERISTICS

These isolators are suitable for reinforced electrical isolation only within the safety limit data. Maintenance of the safety data is ensured by the protective circuits. The asterisk (*) marking on packages denotes DIN EN 69747-5-2 (VDE 0884 Teil 2):2003-1 approval.

Table 17. VDE Characteristics

Description	Conditions	Symbol	Characteristic	Unit
Installation Classification per DIN VDE 0110 For Rated Mains Voltage ≤ 150 V rms For Rated Mains Voltage ≤ 300 V rms For Rated Mains Voltage ≤ 400 V rms			I to IV I to III I to II	
Climatic Classification			40/105/21	
Pollution Degree per DIN VDE 0110, Table 1			2	
Maximum Working Insulation Voltage		V _{IORM}	565	V peak
Input-to-Output Test Voltage, Method b1	V _{IORM} × 1.875 = V _{PR} , 100% production test, t _m = 1 sec, partial discharge < 5 pC	V _{PR}	1059	V peak
Input-to-Output Test Voltage, Method a		V _{PR}		
After Environmental Tests Subgroup 1	V _{IORM} × 1.6 = V _{PR} , t _m = 60 sec, partial discharge < 5 pC		904	V peak
After Input and/or Safety Test Subgroup 2 and Subgroup 3	V _{IORM} × 1.2 = V _{PR} , t _m = 60 sec, partial discharge < 5 pC		678	V peak
Highest Allowable Overvoltage	Transient overvoltage, t _{TR} = 10 sec	V _{TR}	4000	V peak
Safety Limiting Values	Maximum value allowed in the event of a failure (see Figure 5)			
Case Temperature		T _S	150	°C
Side 1 I _{DD1} Current		I _{S1}	555	mA
Insulation Resistance at T _S	V _{IO} = 500 V	R _S	>10 ⁹	Ω

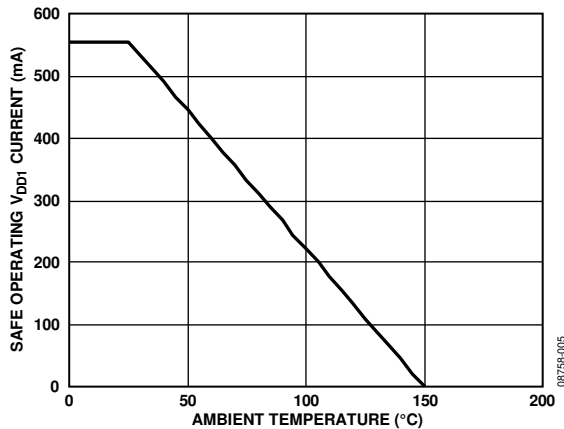

Figure 5. Thermal Derating Curve, Dependence of Safety Limiting Values on Case Temperature, per DIN EN 60747-5-2

RECOMMENDED OPERATING CONDITIONS

Table 18.

Parameter	Symbol	Min	Max	Unit
Operating Temperature ¹	T _A	-40	+105	°C
Supply Voltages ²	V _{DD1}	3.0	5.5	V

¹ Operation at 105°C requires reduction of the maximum load current, as specified in Table 19.

² Each voltage is relative to its respective ground.

ABSOLUTE MAXIMUM RATINGS

Ambient temperature = 25°C, unless otherwise noted.

Table 19.

Parameter	Rating
Storage Temperature (T_{ST})	-55°C to +150°C
Ambient Operating Temperature Range (T_A)	-40°C to +105°C
Supply Voltages (V_{DD1} , V_{ISO}) ¹	-0.5 V to +7.0 V
V_{ISO} Supply Current ²	
$T_A = -40^\circ\text{C}$ to $+85^\circ\text{C}$	100 mA
$T_A = -40^\circ\text{C}$ to $+105^\circ\text{C}$	60 mA
Input Voltage (V_{IA} , V_{IB} , V_{IC} , V_{ID}) ^{1, 3}	-0.5 V to $V_{DD1} + 0.5$ V
Output Voltage (R_{COUT} , V_{OA} , V_{OB} , V_{OC} , V_{OD}) ^{1, 3}	-0.5 V to $V_{DD0} + 0.5$ V
Average Output Current Per Data Output Pin ⁴	-10 mA to +10 mA
Maximum Cumulative AC HiPot	5 min at 2500 V rms
Maximum Cumulative DC HiPot	5 min at 3500 V _{DC}
Common-Mode Transients ⁵	-100 kV/ μ s to +100 kV/ μ s

¹ All voltages are relative to their respective grounds.

² V_{ISO} provides current for dc and dynamic loads on the V_{ISO} I/O channels. This current must be included when determining the total V_{ISO} supply current. For ambient temperatures from 85°C to 105°C, the maximum allowed current is reduced.

³ V_{DD1} and V_{DD0} refer to the supply voltages on the input and output sides of a given channel, respectively. See the PCB Layout section.

⁴ See Figure 5 for the maximum rated current values for various temperatures.

⁵ Refers to common-mode transients across the insulation barrier. Common-mode transients exceeding the absolute maximum ratings may cause latch-up or permanent damage.

Stresses above those listed under Absolute Maximum Ratings may cause permanent damage to the device. This is a stress rating only; functional operation of the device at these or any other conditions above those indicated in the operational section of this specification is not implied. Exposure to absolute maximum rating conditions for extended periods may affect device reliability.

Table 20. Maximum Continuous Working Voltage Supporting 50-Year Minimum Lifetime¹

Parameter	Max	Unit	Applicable Certification
AC Voltage			
Bipolar Waveform	424	V peak	All certifications, 50-year operation
Basic Insulation	560	V peak	Working voltage per IEC 60950-1
Unipolar Waveform			
Basic Insulation	560	V peak	Working voltage per IEC 60950-1
DC Voltage			
Basic Insulation	560	V peak	Working voltage per IEC 60950-1

¹ Refers to the continuous voltage magnitude imposed across the isolation barrier. See the Insulation Lifetime section for more information.

ESD CAUTION



ESD (electrostatic discharge) sensitive device. Charged devices and circuit boards can discharge without detection. Although this product features patented or proprietary protection circuitry, damage may occur on devices subjected to high energy ESD. Therefore, proper ESD precautions should be taken to avoid performance degradation or loss of functionality.

PIN CONFIGURATIONS AND FUNCTION DESCRIPTIONS

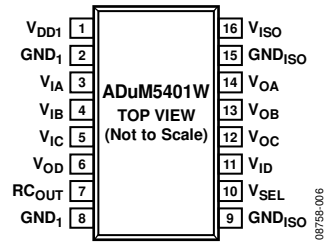

Figure 6. ADuM5401W Pin Configuration

Table 21. ADuM5401W Pin Function Descriptions

Pin No.	Mnemonic	Description
1	V _{DD1}	Primary Supply Voltage, 3.0 V to 5.5 V.
2, 8	GND ₁	Ground Reference for the Primary Side of the Isolator. Pin 2 and Pin 8 are internally connected to each other, and it is recommended that both pins be connected to a common ground.
3	V _{IA}	Logic Input A.
4	V _{IB}	Logic Input B.
5	V _{IC}	Logic Input C.
6	V _{OD}	Logic Output D.
7	RC _{OUT}	Regulation Control Output. This pin is connected to the RC _{IN} pin of a slave <i>iso</i> Power device to allow the ADuM5401W to control the regulation of the slave device.
9, 15	GND _{ISO}	Ground Reference for the Secondary Side of the Isolator. Pin 9 and Pin 15 are internally connected to each other, and it is recommended that both pins be connected to a common ground.
10	V _{SEL}	Output Voltage Selection. When V _{SEL} = V _{ISO} , the V _{ISO} setpoint is 5.0 V. When V _{SEL} = GND _{ISO} , the V _{ISO} setpoint is 3.3 V.
11	V _{ID}	Logic Input D.
12	V _{OC}	Logic Output C.
13	V _{OB}	Logic Output B.
14	V _{OA}	Logic Output A.
16	V _{ISO}	Secondary Supply Voltage Output for External Loads: 3.3 V (V _{SEL} = GND _{ISO}) or 5.0 V (V _{SEL} = V _{ISO}).

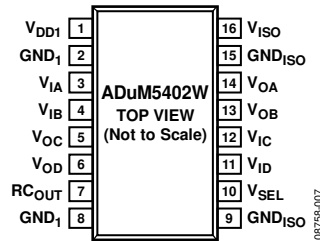

Figure 7. ADuM5402W Pin Configuration

Table 22. ADuM5402W Pin Function Descriptions

Pin No.	Mnemonic	Description
1	V _{DD1}	Primary Supply Voltage, 3.0 V to 5.5 V.
2, 8	GND ₁	Ground Reference for the Primary Side of the Isolator. Pin 2 and Pin 8 are internally connected to each other, and it is recommended that both pins be connected to a common ground.
3	V _{IA}	Logic Input A.
4	V _{IB}	Logic Input B.
5	V _{OC}	Logic Output C.
6	V _{OD}	Logic Output D.
7	RC _{OUT}	Regulation Control Output. This pin is connected to the RC _{IN} pin of a slave <i>iso</i> Power device to allow the ADuM5402W to control the regulation of the slave device.
9, 15	GND _{ISO}	Ground Reference for the Secondary Side of the Isolator. Pin 9 and Pin 15 are internally connected to each other, and it is recommended that both pins be connected to a common ground.
10	V _{SEL}	Output Voltage Selection. When V _{SEL} = V _{ISO} , the V _{ISO} setpoint is 5.0 V. When V _{SEL} = GND _{ISO} , the V _{ISO} setpoint is 3.3 V.
11	V _{ID}	Logic Input D.
12	V _{IC}	Logic Input C.
13	V _{OB}	Logic Output B.
14	V _{OA}	Logic Output A.
16	V _{ISO}	Secondary Supply Voltage Output for External Loads: 3.3 V (V _{SEL} = GND _{ISO}) or 5.0 V (V _{SEL} = V _{ISO}).

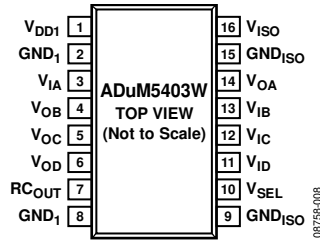

Figure 8. ADuM5403W Pin Configuration

Table 23. ADuM5403W Pin Function Descriptions

Pin No.	Mnemonic	Description
1	V _{DD1}	Primary Supply Voltage, 3.0 V to 5.5 V.
2, 8	GND ₁	Ground Reference for the Primary Side of the Isolator. Pin 2 and Pin 8 are internally connected to each other, and it is recommended that both pins be connected to a common ground.
3	V _{IA}	Logic Input A.
4	V _{OB}	Logic Output B.
5	V _{OC}	Logic Output C.
6	V _{OD}	Logic Output D.
7	RC _{OUT}	Regulation Control Output. This pin is connected to the RC _{IN} pin of a slave <i>iso</i> Power device to allow the ADuM5403W to control the regulation of the slave device.
9, 15	GND _{ISO}	Ground Reference for the Secondary Side of the Isolator. Pin 9 and Pin 15 are internally connected to each other, and it is recommended that both pins be connected to a common ground.
10	V _{SEL}	Output Voltage Selection. When V _{SEL} = V _{ISO} , the V _{ISO} setpoint is 5.0 V. When V _{SEL} = GND _{ISO} , the V _{ISO} setpoint is 3.3 V.
11	V _{ID}	Logic Input D.
12	V _{IC}	Logic Input C.
13	V _{IB}	Logic Input B.
14	V _{OA}	Logic Output A.
16	V _{ISO}	Secondary Supply Voltage Output for External Loads: 3.3 V (V _{SEL} = GND _{ISO}) or 5.0 V (V _{SEL} = V _{ISO}).

TRUTH TABLE

Table 24. Truth Table (Positive Logic)

V _{SEL}	RC _{OUT} ¹	V _{DD1} (V)	V _{ISO} (V)	Notes
High	PWM	5	5	Master mode, normal operation
Low	PWM	5	3.3	Master mode, normal operation
Low	PWM	3.3	3.3	Master mode, normal operation
High	PWM	3.3	5	This supply configuration is not recommended due to extremely poor efficiency

¹ PWM refers to the regulation control signal. This signal is derived from the secondary side regulator and can be used to control other *iso*Power devices.

TYPICAL PERFORMANCE CHARACTERISTICS

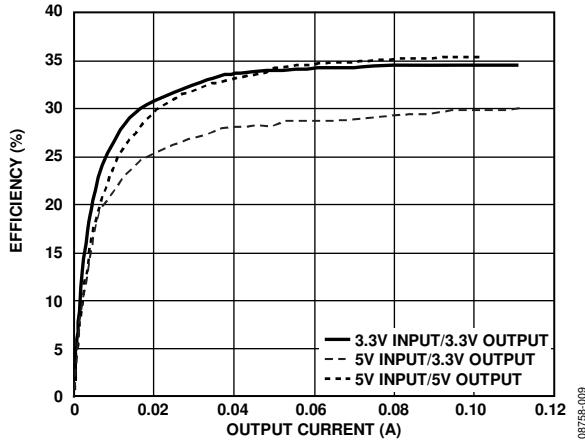

Figure 9. Typical Power Supply Efficiency at 5 V Input/5 V Output and 3.3 V Input/3.3 V Output

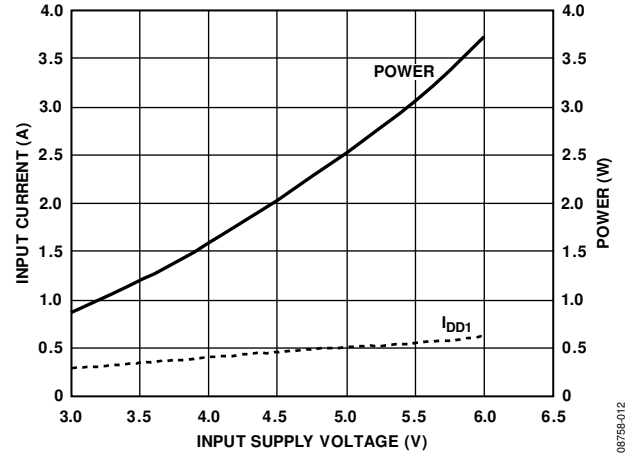

Figure 12. Typical Short-Circuit Input Current and Power vs. V_{DD1} Supply Voltage

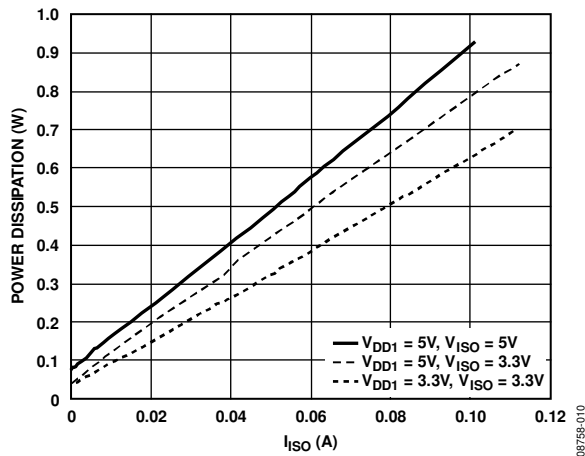

Figure 10. Typical Total Power Dissipation vs. Isolated Output Supply Current in All Supported Power Configurations

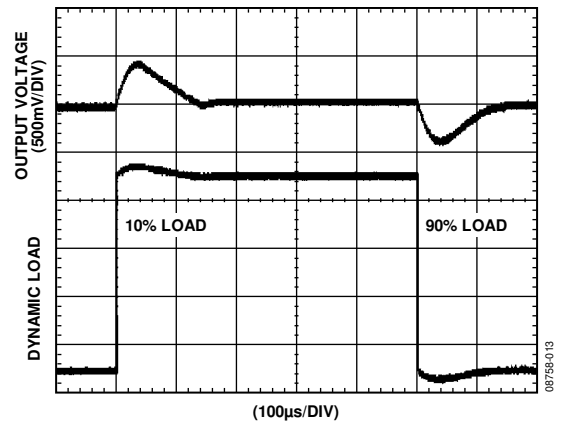

Figure 13. Typical V_{ISO} Transient Load Response, 5 V Output, 10% to 90% Load Step

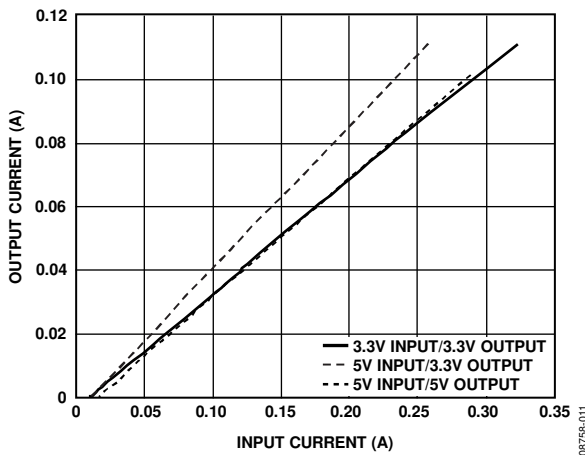

Figure 11. Typical Isolated Output Supply Current vs. Input Current in All Supported Power Configurations

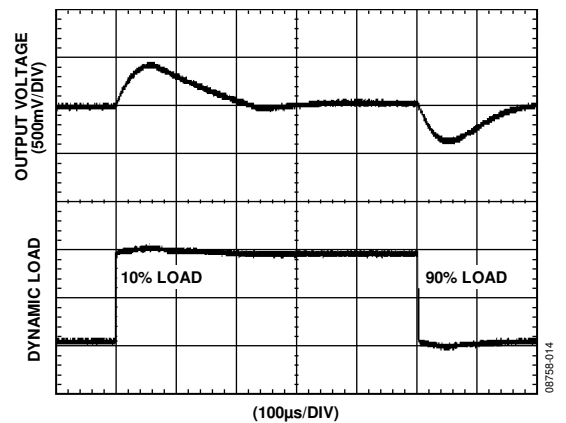

Figure 14. Typical V_{ISO} Transient Load Response, 3.3 V Output, 10% to 90% Load Step

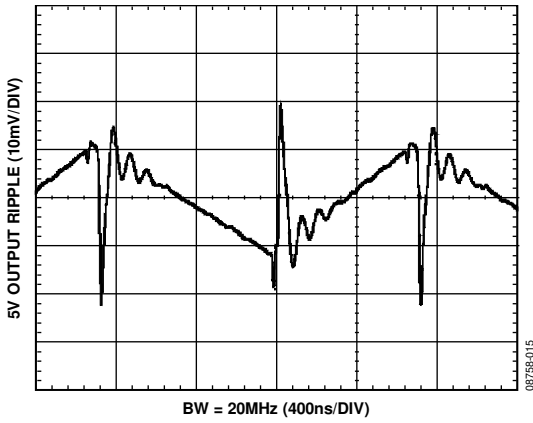

Figure 15. Typical $V_{ISO} = 5\text{ V}$ Output Voltage Ripple at 90% Load

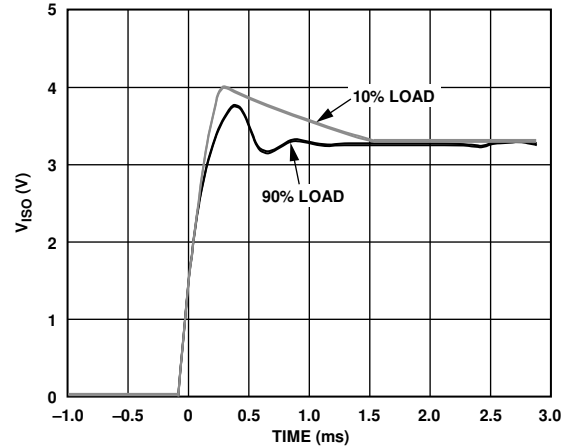

Figure 18. Typical Output Voltage Start-Up Transient at 10% and 90% Load, $V_{ISO} = 3.3\text{ V}$

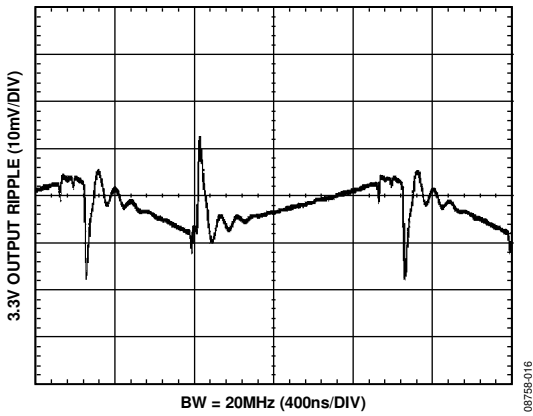

Figure 16. Typical $V_{ISO} = 3.3\text{ V}$ Output Voltage Ripple at 90% Load

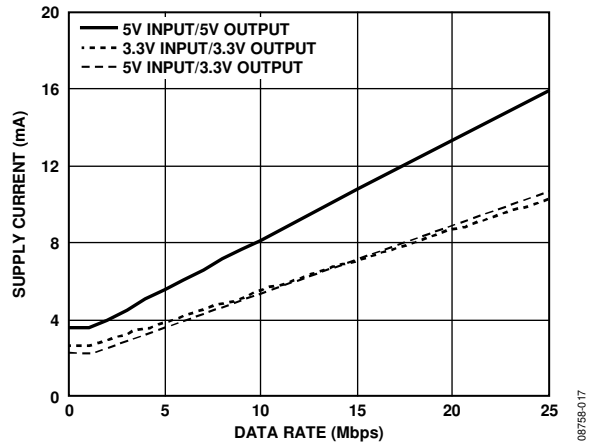

Figure 19. Typical I_{CH} Supply Current per Forward Data Channel (15 pF Output Load)

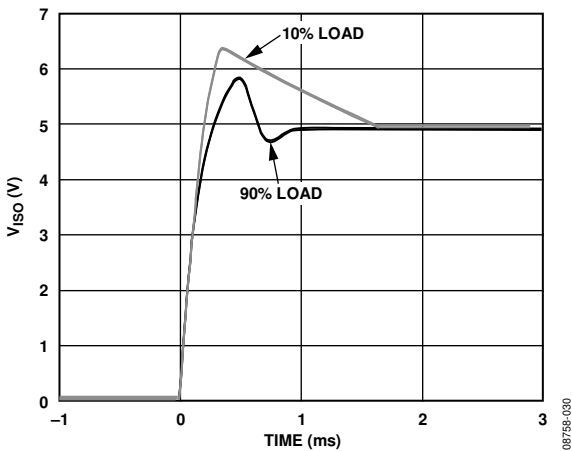

Figure 17. Typical Output Voltage Start-Up Transient at 10% and 90% Load, $V_{ISO} = 5\text{ V}$

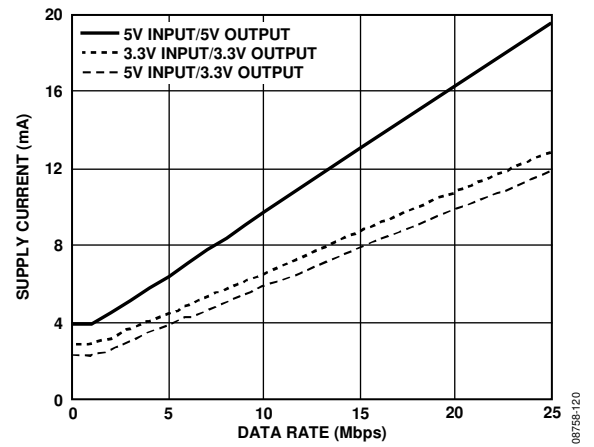

Figure 20. Typical I_{CH} Supply Current per Reverse Data Channel (15 pF Output Load)

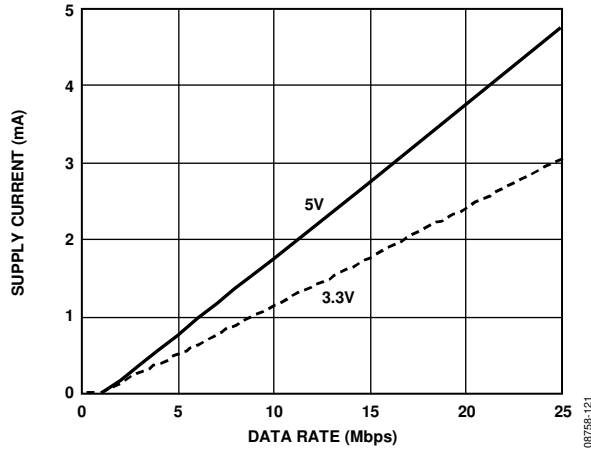

Figure 21. Typical $I_{ISO(D)}$ Dynamic Supply Current per Input

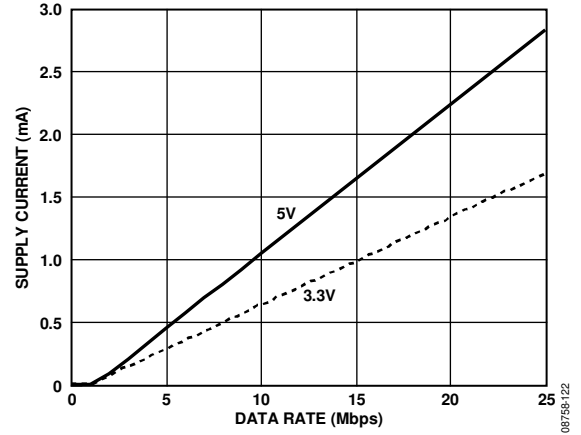

Figure 22. Typical $I_{ISO(D)}$ Dynamic Supply Current per Output (15 pF Output Load)

TERMINOLOGY

$I_{DD1(Q)}$

$I_{DD1(Q)}$ is the minimum operating current drawn at the V_{DD1} pin when there is no external load at V_{ISO} and the I/O pins are operating below 2 Mbps, requiring no additional dynamic supply current. $I_{DD1(Q)}$ reflects the minimum current operating condition.

$I_{DD1(D)}$

$I_{DD1(D)}$ is the typical input supply current with all channels simultaneously driven at a maximum data rate of 25 Mbps with full capacitive load representing the maximum dynamic load conditions. Resistive loads on the outputs should be treated separately from the dynamic load.

$I_{DD1(MAX)}$

$I_{DD1(MAX)}$ is the input current under full dynamic and V_{ISO} load conditions.

$I_{ISO(LOAD)}$

$I_{ISO(LOAD)}$ is the current available to an external V_{ISO} load.

t_{PHL} Propagation Delay

t_{PHL} propagation delay is measured from the 50% level of the falling edge of the V_{IX} signal to the 50% level of the falling edge of the V_{OX} signal.

t_{PLH} Propagation Delay

t_{PLH} propagation delay is measured from the 50% level of the rising edge of the V_{IX} signal to the 50% level of the rising edge of the V_{OX} signal.

Propagation Delay Skew (t_{PSK})

t_{PSK} is the magnitude of the worst-case difference in t_{PHL} and/or t_{PLH} that is measured between units at the same operating temperature, supply voltages, and output load within the recommended operating conditions.

Channel-to-Channel Matching (t_{PSKCD}/t_{PSKOD})

Channel-to-channel matching is the absolute value of the difference in propagation delays between the two channels when operated with identical loads.

Minimum Pulse Width

The minimum pulse width is the shortest pulse width at which the specified pulse width distortion is guaranteed.

Maximum Data Rate

The maximum data rate is the fastest data rate at which the specified pulse width distortion is guaranteed.

APPLICATIONS INFORMATION

THEORY OF OPERATION

The dc-to-dc converter section of the [ADuM5401W/ADuM5402W/ADuM5403W](#) works on principles that are common to most modern power supplies. It is a secondary side controller architecture with isolated pulse-width modulation (PWM) feedback. V_{DD1} power is supplied to an oscillating circuit that switches current into a chip scale air core transformer. Power transferred to the secondary side is rectified and regulated to either 3.3 V or 5 V. The secondary (V_{ISO}) side controller regulates the output by creating a PWM control signal that is sent to the primary (V_{DD1}) side by a dedicated *iCoupler* data channel. The PWM modulates the oscillator circuit to control the power being sent to the secondary side. Feedback allows for significantly higher power and efficiency.

The [ADuM5401W/ADuM5402W/ADuM5403W](#) implement undervoltage lockout (UVLO) with hysteresis on the V_{DD1} power input. This feature ensures that the converter does not enter oscillation due to noisy input power or slow power-on ramp rates.

In the original ADuM540xW devices, a minimum load current of 10 mA is recommended to ensure optimum load regulation. Smaller loads can generate excess noise on chip due to short or erratic PWM pulses. Excess noise generated in this way can cause data corruption in some circumstances. This requirement has been removed in the newer ADuM540xW-1 devices, which are recommended for new designs.

PCB LAYOUT

The [ADuM5401W/ADuM5402W/ADuM5403W](#) digital isolators with 0.5 W *isoPower* integrated dc-to-dc converters require no external interface circuitry for the logic interfaces. Power supply bypassing is required at the input and output supply pins (see Figure 23). Note that a low ESR bypass capacitor is required between Pin 1 and Pin 2 as well as between Pin 15 and Pin 16, as close to the chip pads as possible.

The power supply section of the [ADuM5401W/ADuM5402W/ADuM5403W](#) uses a 180 MHz oscillator frequency to efficiently pass power through its chip scale transformers. In addition, normal operation of the data section of the *iCoupler* introduces switching transients on the power supply pins. Bypass capacitors are required for several operating frequencies. Noise suppression requires a low inductance, high frequency capacitor; ripple suppression and proper regulation require a large value capacitor. These are most conveniently connected between Pin 1 and Pin 2 for V_{DD1} and between Pin 15 and Pin 16 for V_{ISO} . To suppress noise and reduce ripple, a parallel combination of at least two capacitors is required. The recommended capacitor values are 0.1 μ F and 10 μ F for V_{DD1} and V_{ISO} . A 10 nF capacitor should be used for optimum EMI emissions performance. The smaller capacitors must have a low ESR; for example, use of an NPO ceramic capacitor is advised.

Note that the total lead length between the ends of the low ESR capacitor and the input power supply pin must not exceed 2 mm. Installing the bypass capacitor with traces more than 2 mm in length may result in data corruption. A bypass between Pin 1 and Pin 8 and between Pin 9 and Pin 16 should also be considered unless both common ground pins are connected together close to the package.

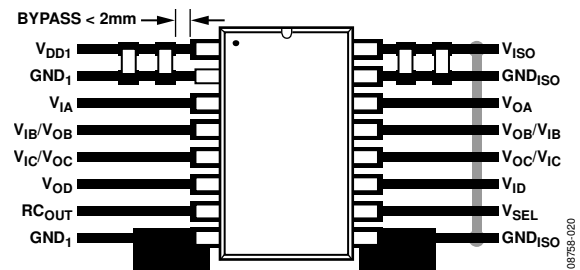

Figure 23. Recommended Printed Circuit Board Layout

In applications involving high common-mode transients, ensure that board coupling across the isolation barrier is minimized. Furthermore, design the board layout such that any coupling that does occur affects all pins equally on a given component side. Failure to ensure this can cause voltage differentials between pins, exceeding the absolute maximum ratings specified in Table 19, thereby leading to latch-up and/or permanent damage.

The [ADuM5401W/ADuM5402W/ADuM5403W](#) are power devices that dissipate about 1 W of power when fully loaded and running at maximum speed. Because it is not possible to apply a heat sink to an isolation device, the devices primarily depend on heat dissipation into the PCB through the ground pins. If the devices are used at high ambient temperatures, provide a thermal path from the ground pins to the PCB ground plane. The board layout in Figure 23 shows enlarged pads for Pin 8 and Pin 9. Large diameter vias should be implemented from the pad to the ground, and power planes should be used to reduce inductance. Multiple vias in the thermal pads can significantly reduce temperatures inside the chip. The dimensions of the expanded pads are left to the discretion of the designer and the available board space.

THERMAL ANALYSIS

The [ADuM5401W/ADuM5402W/ADuM5403W](#) parts consist of four internal die attached to a split lead frame with two die attach paddles. For the purposes of thermal analysis, the die is treated as a thermal unit, with the highest junction temperature reflected in the θ_{JA} value from Table 14. The value of θ_{JA} is based on measurements taken with the parts mounted on a JEDEC standard, 4-layer board with fine width traces and still air. Under normal operating conditions, the [ADuM5401W/ADuM5402W/ADuM5403W](#) devices operate at full load across the full temperature range without derating the output current. However, following the recommendations in the PCB Layout section decreases thermal resistance to the PCB, allowing increased thermal margins in high ambient temperatures.

PROPAGATION DELAY RELATED PARAMETERS

Propagation delay is a parameter that describes the time it takes a logic signal to propagate through a component (see Figure 24). The propagation delay to a logic low output may differ from the propagation delay to a logic high.

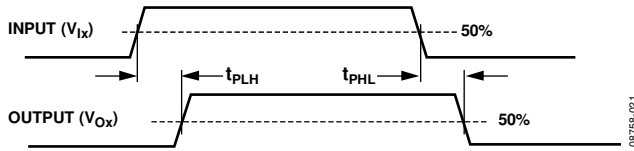

Figure 24. Propagation Delay Parameters

Pulse width distortion is the maximum difference between these two propagation delay values and is an indication of how accurately the input signal timing is preserved.

Channel-to-channel matching refers to the maximum amount the propagation delay differs between channels within a single ADuM5401W/ADuM5402W/ADuM5403W component.

Propagation delay skew refers to the maximum amount the propagation delay differs between multiple ADuM5401W/ADuM5402W/ADuM5403W components operating under the same conditions.

START-UP BEHAVIOR

The ADuM5401W/ADuM5402W/ADuM5403W do not contain a soft start circuit. Therefore, the start-up current and voltage behavior must be taken into account when designing with these devices.

When power is applied to V_{DD1} , the input switching circuit begins to operate and draw current when the UVLO minimum voltage is reached. The switching circuit drives the maximum available power to the output until it reaches the regulation voltage where PWM control begins. The amount of current and the time required to reach regulation voltage depends on the load and the V_{DD1} slew rate.

With a fast V_{DD1} slew rate (200 μ s or less), the peak current draws up to 100 mA/V of V_{DD1} . The input voltage goes high faster than the output can turn on; therefore, the peak current is proportional to the maximum input voltage.

With a slow V_{DD1} slew rate (in the millisecond range), the input voltage is not changing quickly when V_{DD1} reaches the UVLO minimum voltage. The current surge is approximately 300 mA because V_{DD1} is nearly constant at the 2.7 V UVLO voltage. The behavior during startup is similar to when the device load is a short circuit; these values are consistent with the short-circuit current shown in Figure 12.

When starting the device for $V_{ISO} = 5$ V operation, do not limit the current available to the V_{DD1} power pin to less than 300 mA. The ADuM5401W/ADuM5402W/ADuM5403W devices may not be able to drive the output to the regulation point if a current-limiting device clamps the V_{DD1} voltage during startup.

As a result, the ADuM5401W/ADuM5402W/ADuM5403W devices can draw large amounts of current at low voltage for extended periods of time.

The output voltage of the ADuM5401W/ADuM5402W/ADuM5403W devices exhibits VISO overshoot during startup. If this overshoot could potentially damage components attached to V_{ISO} , a voltage-limiting device such as a Zener diode can be used to clamp the voltage. Typical behavior is shown in Figure 17 and Figure 18.

EMI CONSIDERATIONS

The dc-to-dc converter section of the ADuM5401W/ADuM5402W/ADuM5403W components must, of necessity, operate at a very high frequency to allow efficient power transfer through the small transformers. This creates high frequency currents that can propagate in circuit board ground and power planes, causing edge and dipole radiation. Grounded enclosures are recommended for applications that use these devices. If grounded enclosures are not possible, follow good RF design practices in the layout of the PCB. See the AN-0971 Application Note for board layout recommendations.

DC CORRECTNESS AND MAGNETIC FIELD IMMUNITY

Positive and negative logic transitions at the isolator input cause narrow (~ 1 ns) pulses to be sent to the decoder via the transformer. The decoder is bistable and is, therefore, either set or reset by the pulses, indicating input logic transitions. In the absence of logic transitions at the input for more than 1 μ s, periodic sets of refresh pulses indicative of the correct input state are sent to ensure dc correctness at the output. If the decoder receives no internal pulses for more than approximately 5 μ s, the input side is assumed to be unpowered or nonfunctional, in which case, the isolator output is forced to a default low state by the watchdog timer circuit. This situation should occur only during power-up and power-down operations.

The limitation on the magnetic field immunity of the ADuM5401W/ADuM5402W/ADuM5403W is set by the condition in which induced voltage in the receiving coil of the transformer is sufficiently large to either falsely set or reset the decoder. The following analysis defines the conditions under which this can occur.

The pulses at the transformer output have an amplitude of >1.0 V. The decoder has a sensing threshold of about 0.5 V, thus establishing a 0.5 V margin in which induced voltages can be tolerated. The voltage induced across the receiving coil is given by

$$V = (-d\beta/dt)\sum\pi r_n^2; n = 1, 2, \dots, N$$

where:

β is the magnetic flux density (gauss).

r_n is the radius of the n^{th} turn in the receiving coil (cm).

N is the number of turns in the receiving coil.

Given the geometry of the receiving coil in the ADuM5401W/ADuM5402W/ADuM5403W, and an imposed requirement that

the induced voltage be, at most, 50% of the 0.5 V margin at the decoder, a maximum allowable magnetic field is calculated as shown in Figure 25.

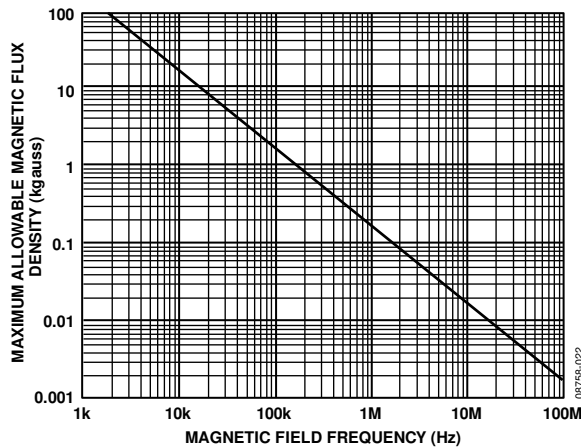

Figure 25. Maximum Allowable External Magnetic Flux Density

For example, at a magnetic field frequency of 1 MHz, the maximum allowable magnetic field of 0.2 kgauss induces a voltage of 0.25 V at the receiving coil. This voltage is approximately 50% of the sensing threshold and does not cause a faulty output transition. Similarly, if such an event occurs during a transmitted pulse (and is of the worst-case polarity), it reduces the received pulse from >1.0 V to 0.75 V, which is still well above the 0.5 V sensing threshold of the decoder.

The preceding magnetic flux density values correspond to specific current magnitudes at given distances from the ADuM5401W/ADuM5402W/ADuM5403W transformers. Figure 26 expresses these allowable current magnitudes as a function of frequency for selected distances. As shown in Figure 26, the ADuM5401W/ADuM5402W/ADuM5403W are extremely immune and can be affected only by extremely large currents operated at high frequency very close to the component. For the 1 MHz example, a 0.5 kA current placed 5 mm away from the ADuM5401W/ADuM5402W/ADuM5403W is required to affect component operation.

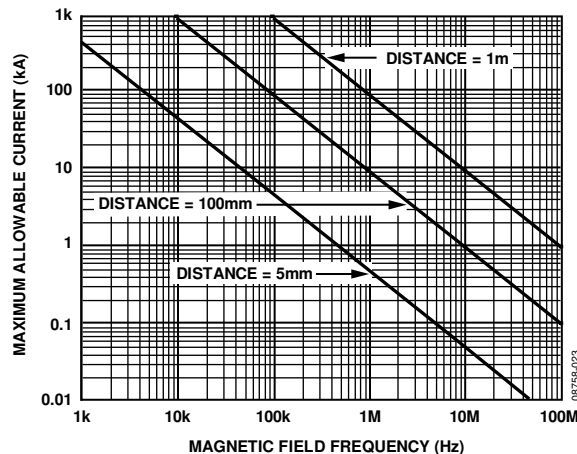

Figure 26. Maximum Allowable Current for Various Current-to-ADuM5401W/ADuM5402W/ADuM5403W Spacings

Note that, in combinations of strong magnetic field and high frequency, any loops formed by PCB traces can induce error voltages sufficiently large to trigger the thresholds of succeeding circuitry. Exercise care in the layout of such traces to avoid this possibility.

POWER CONSUMPTION

The V_{DD1} power supply input provides power to the iCoupler data channels, as well as to the power converter. For this reason, the quiescent currents drawn by the power converter and the primary and secondary I/O channels cannot be determined separately. All of these quiescent power demands have been combined into the I_{DD1(Q)} current, as shown in Figure 27. The total I_{DD1} supply current is equal to the sum of the quiescent operating current; the dynamic current, I_{DD1(D)}, demanded by the I/O channels; and any external I_{ISO} load.

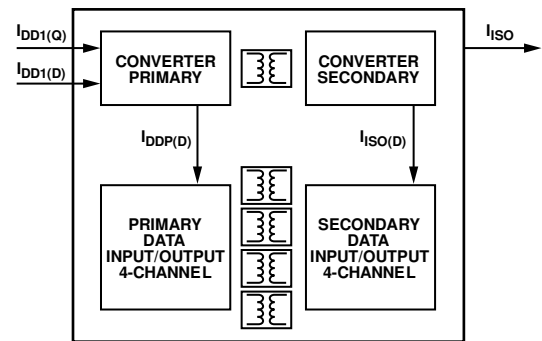

Figure 27. Power Consumption Within the ADuM5401W/ADuM5402W/ADuM5403W

Dynamic I/O current is consumed only when operating a channel at speeds higher than the refresh rate of *f*. The dynamic current of each channel is determined by its data rate. Figure 19 shows the current for a channel in the forward direction, meaning that the input is on the V_{DD1} side of the part; Figure 20 shows the current for a channel in the reverse direction, meaning that the input is on the V_{ISO} side of the part. Both figures assume a typical 15 pF load. The following relationship allows the total I_{DD1} current to be calculated:

$$I_{DD1} = (I_{ISO} \times V_{ISO}) / (E \times V_{DD1}) + \sum I_{CHn}; n = 1 \text{ to } 4 \quad (1)$$

where:

I_{DD1} is the total supply input current.

I_{CHn} is the current drawn by a single channel determined from Figure 19 or Figure 20, depending on channel direction.

I_{ISO} is the current drawn by the secondary side external load.

E is the power supply efficiency at 100 mA load from Figure 9 at the V_{ISO} and V_{DD1} condition of interest.

The maximum external load can be calculated by subtracting the dynamic output load from the maximum allowable load.

$$I_{ISO(LOAD)} = I_{ISO(MAX)} - \sum I_{ISO(D)n}; n = 1 \text{ to } 4 \quad (2)$$

where:

I_{ISO(LOAD)} is the current available to supply an external secondary side load.

I_{ISO(MAX)} is the maximum external secondary side load current

available at V_{ISO} .

$I_{ISO(D)n}$ is the dynamic load current drawn from V_{ISO} by an input or output channel, as shown in Figure 21 and Figure 22.

The preceding analysis assumes a 15 pF capacitive load on each data output. If the capacitive load is larger than 15 pF, the additional current must be included in the analysis of I_{DD1} and $I_{ISO(Load)}$.

POWER CONSIDERATIONS

The [ADuM5401W/ADuM5402W/ADuM5403W](#) power input, data input channels on the primary side, and data channels on the secondary side are all protected from premature operation by UVLO circuitry. Below the minimum operating voltage, the power converter holds its oscillator inactive and all input channel drivers and refresh circuits are idle. Outputs remain in a high impedance state to prevent transmission of undefined states during power-up and power-down operations.

During application of power to V_{DD1} , the primary side circuitry is held idle until the UVLO preset voltage is reached. At that time, the data channels initialize to their default low output state until they receive data pulses from the secondary side.

When the primary side is above the UVLO threshold, the data input channels sample their inputs and begin sending encoded pulses to the inactive secondary output channels. The outputs on the primary side remain in their default low state because no data comes from the secondary side inputs until secondary power is established.

The primary side oscillator also begins to operate, transferring power to the secondary power circuits. The secondary V_{ISO} voltage is below its UVLO limit at this point; the regulation control signal from the secondary is not being generated. The primary side power oscillator is allowed to free run in this circumstance, supplying the maximum amount of power to the secondary side, until the secondary voltage rises to its regulation setpoint. This creates a large inrush current transient at V_{DD1} .

When the regulation point is reached, the regulation control circuit produces the regulation control signal that modulates the oscillator on the primary side. The V_{DD1} current is reduced and is then proportional to the load current. The inrush current is less than the short-circuit current shown in Figure 12. The duration of the inrush current depends on the V_{ISO} loading conditions and the current available at the V_{DD1} pin.

As the secondary side converter begins to accept power from the primary, the V_{ISO} voltage starts to rise. When the secondary side UVLO is reached, the secondary side outputs are initialized to their default low state until data is received from the corresponding primary side input. It can take up to 1 μ s after the secondary side is initialized for the state of the output to correlate with the primary side input.

Secondary side inputs sample their state and transmit it to the primary side. Outputs are valid about 1 μ s after the secondary side becomes active.

Because the rate of charge of the secondary side power supply is dependent on loading conditions, the input voltage, and the output voltage level selected, take care with the design to allow the converter sufficient time to stabilize before valid data is required.

When power is removed from V_{DD1} , the primary side converter and coupler shut down when the UVLO level is reached. The secondary side stops receiving power and starts to discharge. The outputs on the secondary side hold the last state that they received from the primary side. Either the UVLO level is reached and the outputs are placed in their high impedance state, or the outputs detect a lack of activity from the primary side inputs and the outputs are set to their default low value before the secondary power reaches UVLO.

INSULATION LIFETIME

All insulation structures eventually break down when subjected to voltage stress over a sufficiently long period. The rate of insulation degradation is dependent on the characteristics of the voltage waveform applied across the insulation. Analog Devices conducts an extensive set of evaluations to determine the lifetime of the insulation structure within the [ADuM5401W/ADuM5402W/ADuM5403W](#).

Accelerated life testing is performed using voltage levels higher than the rated continuous working voltage. Acceleration factors for several operating conditions are determined, allowing calculation of the time to failure at the working voltage of interest. The values shown in Table 20 summarize the peak voltages for 50 years of service life in several operating conditions. In many cases, the working voltage approved by agency testing is higher than the 50-year service life voltage. Operation at working voltages higher than the service life voltage listed leads to premature insulation failure.

The insulation lifetime of the [ADuM5401W/ADuM5402W/ADuM5403W](#) depends on the voltage waveform type imposed across the isolation barrier. The iCoupler insulation structure degrades at different rates, depending on whether the waveform is bipolar ac, unipolar ac, or dc. Figure 28, Figure 29, and Figure 30 illustrate these different isolation voltage waveforms.

Bipolar ac voltage is the most stringent environment. A 50-year operating lifetime under the bipolar ac condition determines the maximum working voltage recommended by Analog Devices.

In the case of unipolar ac or dc voltage, the stress on the insulation is significantly lower. This allows operation at higher working voltages while still achieving a 50-year service life. The working voltages listed in Table 20 can be applied while maintaining the 50-year minimum lifetime, provided that the voltage conforms to either the unipolar ac or dc voltage cases. Any cross-insulation voltage waveform that does not conform to Figure 29 or Figure 30 should be treated as a bipolar ac waveform, and its peak voltage should be limited to the 50-year lifetime voltage value listed in Table 20.

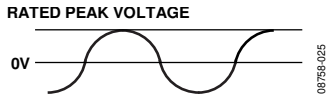

Figure 28. Bipolar AC Waveform

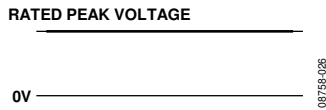
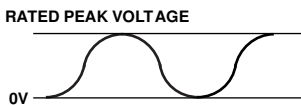

Figure 29. DC Waveform



NOTES
 1. THE VOLTAGE IS SHOWN AS SINUSOIDAL FOR ILLUSTRATION PURPOSES ONLY. IT IS MEANT TO REPRESENT ANY VOLTAGE WAVEFORM VARYING BETWEEN 0V AND SOME LIMITING VALUE. THE LIMITING VALUE CAN BE POSITIVE OR NEGATIVE, BUT THE VOLTAGE CANNOT CROSS 0V.

Figure 30. Unipolar AC Waveform

V_{ISO} START-UP ISSUES

An issue with reliable startup was identified in the [ADuM5401W/ADuM5402W/ADuM5403W](#) components. This issue has been addressed in the [ADuM5401W-1/ADuM5402W-1/ADuM5403W-1](#) for the current silicon. The [ADuM5401W-1/ADuM5402W-1/ADuM5403W-1](#) devices are recommended for all new designs. The following description applies only to the original released version of these devices. Production of the original release of the devices is being continued for existing customers, but it is not recommended for new designs.

The start-up issue in the original release of the [ADuM5401W/ADuM5402W/ADuM5403W](#) is related to initialization of the band gap voltage references on the primary (power input) and secondary (power output) sides of the *isoPower* device and are being addressed in future revisions of the silicon. For current versions of the silicon, the user must follow these design guidelines to guarantee proper operation of the device.

The band gap voltage references are vulnerable to slow power-up slew rate. The susceptibility to power-up errors is process sensitive; therefore, not all devices display these behaviors. These recommendations should be implemented for all designs until the corrections are made to the silicon. The symptoms and corrective actions required for issues with the primary and secondary side startup are different.

Symptom

The V_{ISO} output voltage restarts to an incorrect voltage between 3.4 V and 4.7 V when power is removed at V_{DD1} and then reapplied between 250 ms and 3 sec later. The error occurs only on restart; it does not occur at initial power-up. If the part initializes incorrectly, power must be removed for an extended time to allow internal nodes to discharge and reset. The amount of time required can be several minutes at low temperature; therefore, it is critical to avoid allowing the device to initialize improperly.

Cause

The secondary side band gap reference does not initialize to the proper voltage due to a slow slew rate on V_{ISO} after the internal nodes are precharged during the previous power cycle. The secondary side band gap sets the output voltage of the regulator.

Solution

The slow rate of V_{ISO} is determined by the resistive and capacitive load present on the output. Designs that attempt to reduce ripple by adding capacitance to the V_{ISO} output can slow the slew rate enough to cause start-up errors. Choose values for bulk capacitance based on the effective dc load. Calculate the dc load as the resistive equivalent to the current drawn from the V_{ISO} line. Determine the range of allowable capacitance for the V_{ISO} output from Figure 31. Choose the bulk capacitance for V_{ISO} to achieve the application required ripple, unless the value is in the disallowed combinations area; then the value must be reduced to avoid restart issues.

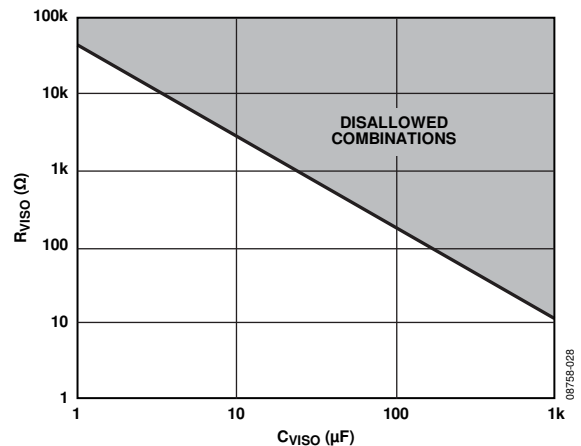
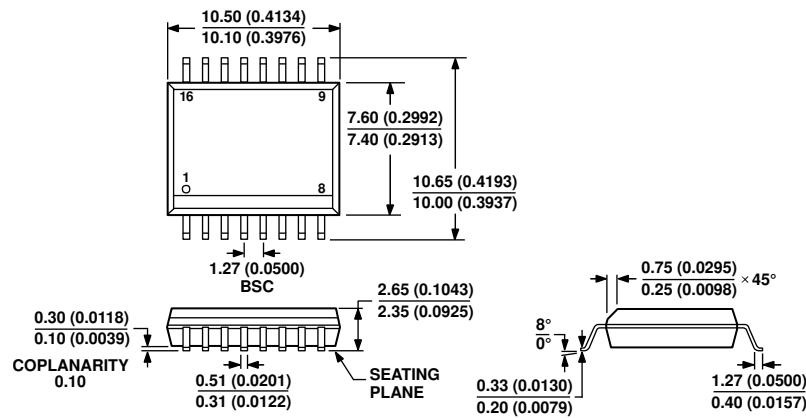

Figure 31. Maximum Capacitive Load for Proper Restart

OUTLINE DIMENSIONS



COMPLIANT TO JEDEC STANDARDS MS-013-AA
CONTROLLING DIMENSIONS ARE IN MILLIMETERS; INCH DIMENSIONS
(IN PARENTHESES) ARE ROUNDED-OFF MILLIMETER EQUIVALENTS FOR
REFERENCE ONLY AND ARE NOT APPROPRIATE FOR USE IN DESIGN.

Figure 32. 16-Lead Standard Small Outline Package [SOIC_W]
Wide Body
(RW-16)

Dimensions shown in millimeters and (inches)

08-27-2007-B

ORDERING GUIDE

Model ^{1, 2, 3}	Notes	Number of Inputs, V _{DD1} Side	Number of Inputs, V _{ISO} Side	Maximum Data Rate (Mbps)	Maximum Propagation Delay, 5 V (ns)	Maximum Pulse Width Distortion (ns)	Temperature Range	Package Description	Package Option
ADuM5401WCRWZ-1		3	1	25	60	6	-40°C to +105°C	16-Lead SOIC_W	RW-16
ADuM5402WCRWZ-1		2	2	25	60	6	-40°C to +105°C	16-Lead SOIC_W	RW-16
ADuM5403WCRWZ-1		1	3	25	60	6	-40°C to +105°C	16-Lead SOIC_W	RW-16
ADuM5401WCRWZ	⁴	3	1	25	60	6	-40°C to +105°C	16-Lead SOIC_W	RW-16
ADuM5402WCRWZ	⁴	2	2	25	60	6	-40°C to +105°C	16-Lead SOIC_W	RW-16
ADuM5403WCRWZ	⁴	1	3	25	60	6	-40°C to +105°C	16-Lead SOIC_W	RW-16

¹ Z = RoHS Compliant Part.

² W = Qualified for Automotive Applications.

³ Tape and reel are available. The addition of an RL suffix designates a 13" (1,000 units) tape and reel option.

⁴ This device is not recommended for new designs.

AUTOMOTIVE PRODUCTS

The [ADuM5401W/ADuM5402W/ADuM5403W](#) models are available with controlled manufacturing to support the quality and reliability requirements of automotive applications. Note that these automotive models may have specifications that differ from the commercial models; therefore, designers should review the Specifications section of this data sheet carefully. Only the automotive grade products shown are available for use in automotive applications. Contact your local Analog Devices account representative for specific product ordering information and to obtain the specific Automotive Reliability reports for these models.