



Chipsmall Limited consists of a professional team with an average of over 10 year of expertise in the distribution of electronic components. Based in Hongkong, we have already established firm and mutual-benefit business relationships with customers from,Europe,America and south Asia,supplying obsolete and hard-to-find components to meet their specific needs.

With the principle of “Quality Parts,Customers Priority,Honest Operation,and Considerate Service”,our business mainly focus on the distribution of electronic components. Line cards we deal with include Microchip,ALPS,ROHM,Xilinx,Pulse,ON,Everlight and Freescale. Main products comprise IC,Modules,Potentiometer,IC Socket,Relay,Connector.Our parts cover such applications as commercial,industrial, and automotives areas.

We are looking forward to setting up business relationship with you and hope to provide you with the best service and solution. Let us make a better world for our industry!



Contact us

Tel: +86-755-8981 8866 Fax: +86-755-8427 6832

Email & Skype: info@chipsmall.com Web: www.chipsmall.com

Address: A1208, Overseas Decoration Building, #122 Zhenhua RD., Futian, Shenzhen, China



ADXL202/ADXL210

FEATURES

- 2-Axis Acceleration Sensor on a Single IC Chip
 - Measures Static Acceleration as Well as Dynamic Acceleration
 - Duty Cycle Output with User Adjustable Period
 - Low Power <0.6 mA
 - Faster Response than Electrolytic, Mercury or Thermal Tilt Sensors
 - Bandwidth Adjustment with a Single Capacitor Per Axis
 - 5 mg Resolution at 60 Hz Bandwidth
 - +3 V to +5.25 V Single Supply Operation
 - 1000 g Shock Survival
- ### APPLICATIONS
- 2-Axis Tilt Sensing
 - Computer Peripherals
 - Inertial Navigation
 - Seismic Monitoring
 - Vehicle Security Systems
 - Battery Powered Motion Sensing

GENERAL DESCRIPTION

The ADXL202/ADXL210 are low cost, low power, complete 2-axis accelerometers with a measurement range of either $\pm 2 g/\pm 10 g$. The ADXL202/ADXL210 can measure both dynamic acceleration (e.g., vibration) and static acceleration (e.g., gravity).

The outputs are digital signals whose duty cycles (ratio of pulse-width to period) are proportional to the acceleration in each of the 2 sensitive axes. These outputs may be measured directly with a microprocessor counter, requiring no A/D converter or glue logic. The output period is adjustable from 0.5 ms to 10 ms via a single resistor (R_{SET}). If a voltage output is desired, a voltage output proportional to acceleration is available from the X_{FILT} and Y_{FILT} pins, or may be reconstructed by filtering the duty cycle outputs.

The bandwidth of the ADXL202/ADXL210 may be set from 0.01 Hz to 5 kHz via capacitors C_X and C_Y . The typical noise floor is $500 \mu g/\sqrt{Hz}$ allowing signals below 5 mg to be resolved for bandwidths below 60 Hz.

The ADXL202/ADXL210 is available in a hermetic 14-lead Surface Mount CERPAK, specified over the $0^\circ C$ to $+70^\circ C$ commercial or $-40^\circ C$ to $+85^\circ C$ industrial temperature range.

FUNCTIONAL BLOCK DIAGRAM

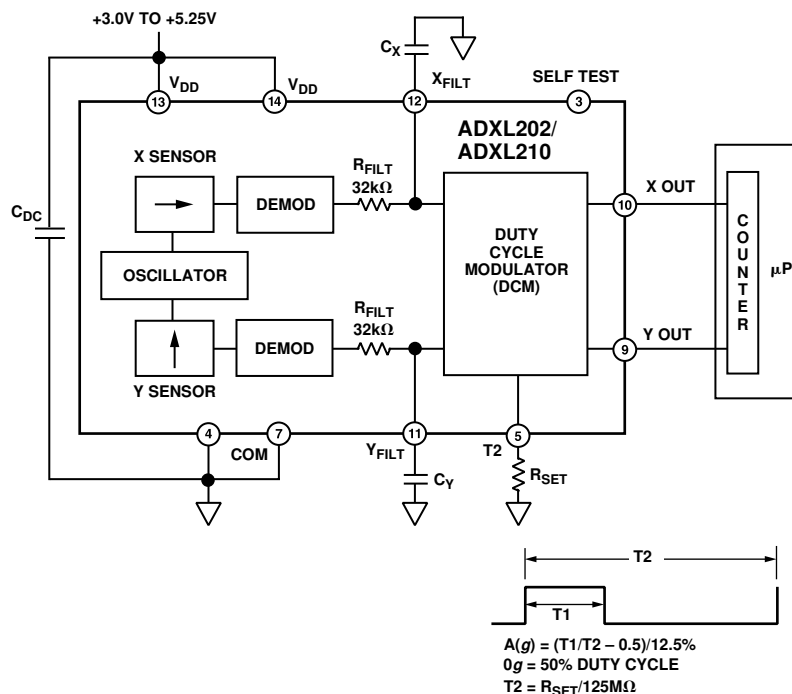

iMEMS is a registered trademark of Analog Devices, Inc.

REV. B

Information furnished by Analog Devices is believed to be accurate and reliable. However, no responsibility is assumed by Analog Devices for its use, nor for any infringements of patents or other rights of third parties which may result from its use. No license is granted by implication or otherwise under any patent or patent rights of Analog Devices.

ADXL202/ADXL210—SPECIFICATIONS ($T_A = T_{MIN}$ to T_{MAX} , $T_A = +25^\circ\text{C}$ for J Grade only, $V_{DD} = +5\text{ V}$, $R_{SET} = 125\text{ k}\Omega$, Acceleration = 0 g , unless otherwise noted)

Parameter	Conditions	ADXL202/JQC/AQC			ADXL210/JQC/AQC			Units
		Min	Typ	Max	Min	Typ	Max	
SENSOR INPUT	Each Axis							
Measurement Range ¹		± 1.5	± 2		± 8	± 10		<i>g</i>
Nonlinearity	Best Fit Straight Line		0.2			0.2		% of FS
Alignment Error ²			± 1			± 1		Degrees
Alignment Error	X Sensor to Y Sensor		± 0.01			± 0.01		Degrees
Transverse Sensitivity ³			± 2			± 2		%
SENSITIVITY	Each Axis							
Duty Cycle per <i>g</i>	T1/T2 @ $+25^\circ\text{C}$	10	12.5	15	3.2	4.0	4.8	%/ <i>g</i>
Sensitivity, Analog Output	At Pins X_{FILT} , Y_{FILT}		312			100		mV/ <i>g</i>
Temperature Drift ⁴	Δ from $+25^\circ\text{C}$		± 0.5			± 0.5		% Rdg
ZERO <i>g</i> BIAS LEVEL	Each Axis							
0 <i>g</i> Duty Cycle	T1/T2	25	50	75	42	50	58	%
Initial Offset			± 2			± 2		<i>g</i>
0 <i>g</i> Duty Cycle vs. Supply			1.0	4.0		1.0	4.0	%/V
0 <i>g</i> Offset vs. Temperature ⁴	Δ from $+25^\circ\text{C}$		2.0			2.0		mg/ $^\circ\text{C}$
NOISE PERFORMANCE								
Noise Density ⁵	@ $+25^\circ\text{C}$		500	1000		500	1000	$\mu\text{g}/\sqrt{\text{Hz}}$
FREQUENCY RESPONSE								
3 dB Bandwidth	Duty Cycle Output		500			500		Hz
3 dB Bandwidth	At Pins X_{FILT} , Y_{FILT}		5			5		kHz
Sensor Resonant Frequency			10			14		kHz
FILTER								
R_{FILT} Tolerance	32 k Ω Nominal		± 15			± 15		%
Minimum Capacitance	At X_{FILT} , Y_{FILT}	1000			1000			μF
SELF TEST								
Duty Cycle Change	Self-Test “0” to “1”		10			10		%
DUTY CYCLE OUTPUT STAGE								
F_{SET}			125 M Ω / R_{SET}			125 M Ω / R_{SET}		
F_{SET} Tolerance	$R_{SET} = 125\text{ k}\Omega$	0.7		1.3	0.7		1.3	kHz
Output High Voltage	$I = 25\ \mu\text{A}$	$V_S - 200\text{ mV}$			$V_S - 200\text{ mV}$			mV
Output Low Voltage	$I = 25\ \mu\text{A}$			200			200	mV
T2 Drift vs. Temperature			35			35		ppm/ $^\circ\text{C}$
Rise/Fall Time			200			200		ns
POWER SUPPLY								
Operating Voltage Range		3.0		5.25	2.7		5.25	V
Specified Performance		4.75		5.25	4.75		5.25	V
Quiescent Supply Current			0.6	1.0		0.6	1.0	mA
Turn-On Time ⁶	To 99%	160 $C_{FILT} + 0.3$			160 $C_{FILT} + 0.3$			ms
TEMPERATURE RANGE								
Operating Range	JQC	0		+70	0		+70	$^\circ\text{C}$
Specified Performance	AQC	-40		+85	-40		+85	$^\circ\text{C}$

NOTES

¹For all combinations of offset and sensitivity variation.

²Alignment error is specified as the angle between the true and indicated axis of sensitivity.

³Transverse sensitivity is the algebraic sum of the alignment and the inherent sensitivity errors.

⁴Specification refers to the maximum change in parameter from its initial at $+25^\circ\text{C}$ to its worst case value at T_{MIN} to T_{MAX} .

⁵Noise density ($\mu\text{g}/\sqrt{\text{Hz}}$) is the average noise at any frequency in the bandwidth of the part.

⁶ C_{FILT} in μF . Addition of filter capacitor will increase turn on time. Please see the Application section on power cycling.

All min and max specifications are guaranteed. Typical specifications are not tested or guaranteed.

Specifications subject to change without notice.

ABSOLUTE MAXIMUM RATINGS*

Acceleration (Any Axis, Unpowered for 0.5 ms) 1000 *g*
 Acceleration (Any Axis, Powered for 0.5 ms) 500 *g*
 +V_S -0.3 V to +7.0 V
 Output Short Circuit Duration
 (Any Pin to Common) Indefinite
 Operating Temperature -55°C to +125°C
 Storage Temperature -65°C to +150°C

*Stresses above those listed under Absolute Maximum Ratings may cause permanent damage to the device. This is a stress rating only; the functional operation of the device at these or any other conditions above those indicated in the operational sections of this specification is not implied. Exposure to absolute maximum rating conditions for extended periods may affect device reliability.

Drops onto hard surfaces can cause shocks of greater than 1000 *g* and exceed the absolute maximum rating of the device. Care should be exercised in handling to avoid damage.

PIN FUNCTION DESCRIPTIONS

Pin	Name	Description
1	NC	No Connect
2	V _{TP}	Test Point, Do Not Connect
3	ST	Self Test
4	COM	Common
5	T2	Connect R _{SET} to Set T2 Period
6	NC	No Connect
7	COM	Common
8	NC	No Connect
9	Y _{OUT}	Y Axis Duty Cycle Output
10	X _{OUT}	X Axis Duty Cycle Output
11	Y _{FILT}	Connect Capacitor for Y Filter
12	X _{FILT}	Connect Capacitor for X Filter
13	V _{DD}	+3 V to +5.25 V, Connect to 14
14	V _{DD}	+3 V to +5.25 V, Connect to 13

PACKAGE CHARACTERISTICS

Package	θ _{JA}	θ _{JC}	Device Weight
14-Lead CERPAK	110°C/W	30°C/W	5 Grams

PIN CONFIGURATION

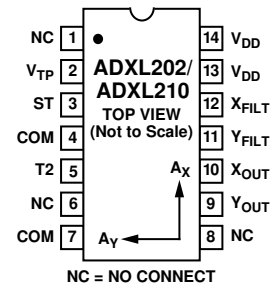

Figure 1 shows the response of the ADXL202 to the Earth's gravitational field. The output values shown are nominal. They are presented to show the user what type of response to expect from each of the output pins due to changes in orientation with respect to the Earth. The ADXL210 reacts similarly with output changes appropriate to its scale.

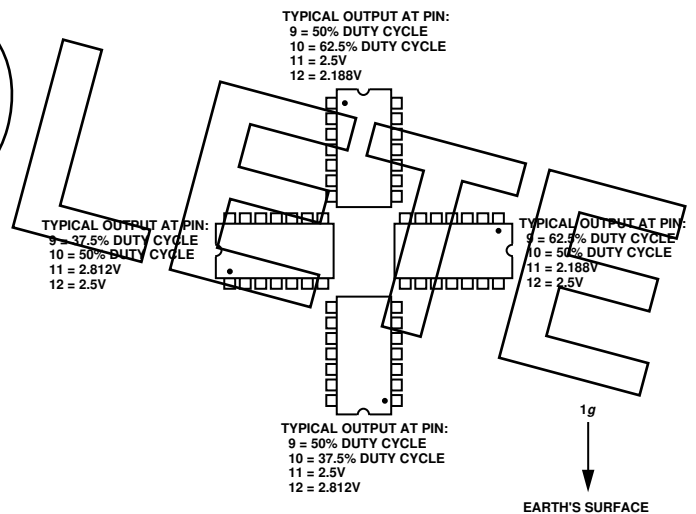

Figure 1. ADXL202/ADXL210 Nominal Response Due to Gravity

ORDERING GUIDE

Model	<i>g</i> Range	Temperature Range	Package Description	Package Option
ADXL202JQC	±2	0°C to +70°C	14-Lead CERPAK	QC-14
ADXL202AQC	±2	-40°C to +85°C	14-Lead CERPAK	QC-14
ADXL210JQC	±10	0°C to +70°C	14-Lead CERPAK	QC-14
ADXL210AQC	±10	-40°C to +85°C	14-Lead CERPAK	QC-14

CAUTION

ESD (electrostatic discharge) sensitive device. Electrostatic charges as high as 4000 V readily accumulate on the human body and test equipment and can discharge without detection. Although the ADXL202/ADXL210 features proprietary ESD protection circuitry, permanent damage may occur on devices subjected to high energy electrostatic discharges. Therefore, proper ESD precautions are recommended to avoid performance degradation or loss of functionality.



ADXL202/ADXL210

TYPICAL CHARACTERISTICS (@ +25°C R_{SET} = 125 kΩ, V_{DD} = +5 V, unless otherwise noted)

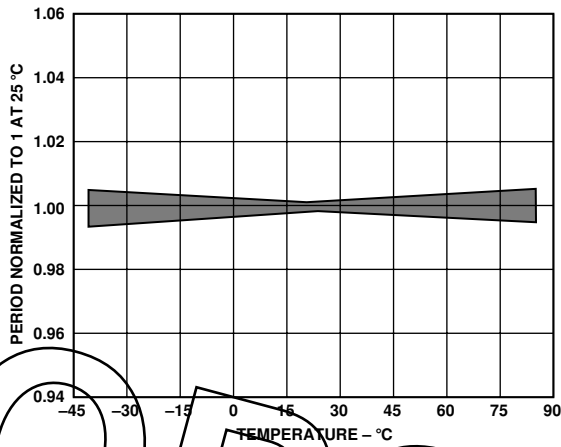

Figure 2. Normalized DCM Period (T2) vs. Temperature

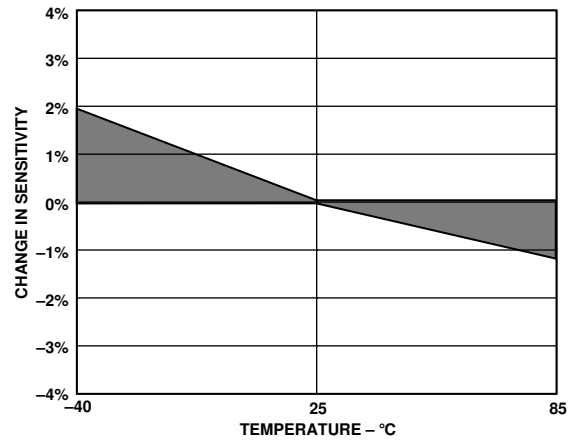

Figure 5. Typical X Axis Sensitivity Drift Due to Temperature

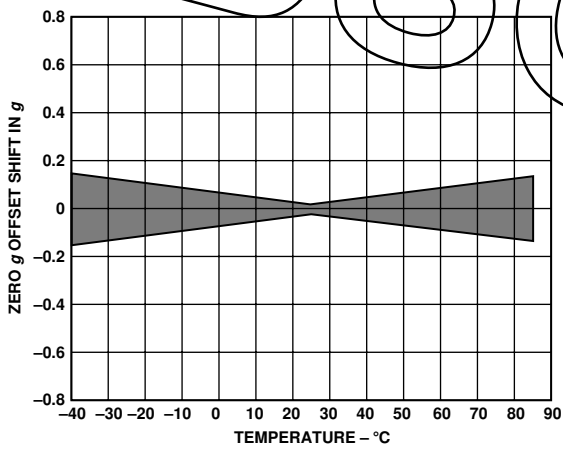

Figure 3. Typical Zero g Offset vs. Temperature

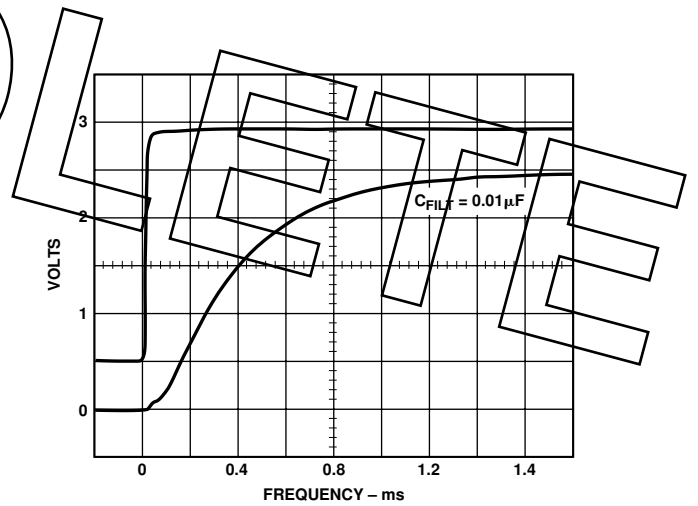

Figure 6. Typical Turn-On Time

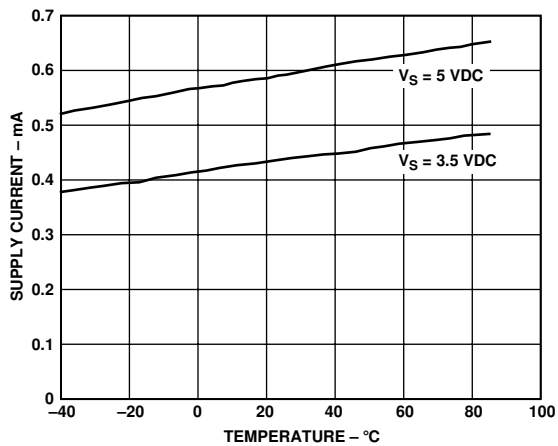

Figure 4. Typical Supply Current vs. Temperature

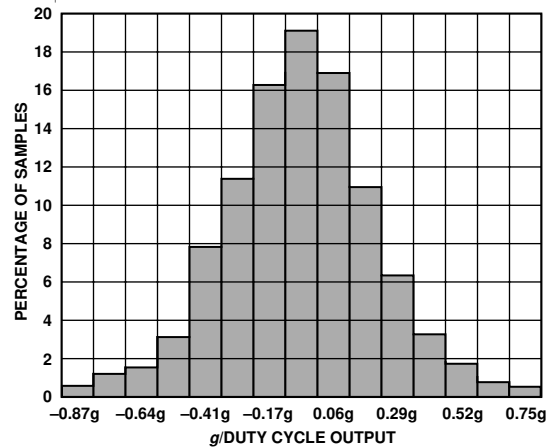

Figure 7. Typical Zero g Distribution at +25°C

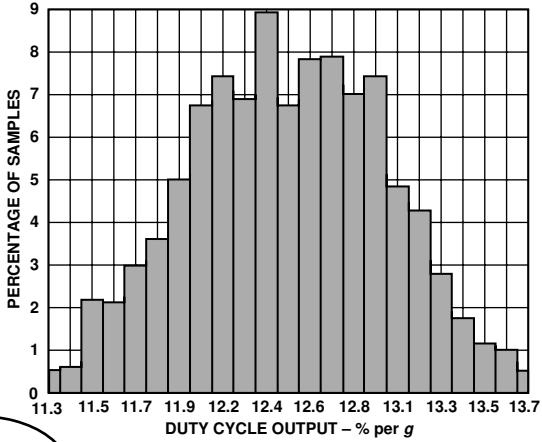

Figure 8. Typical Sensitivity per g at +25°C

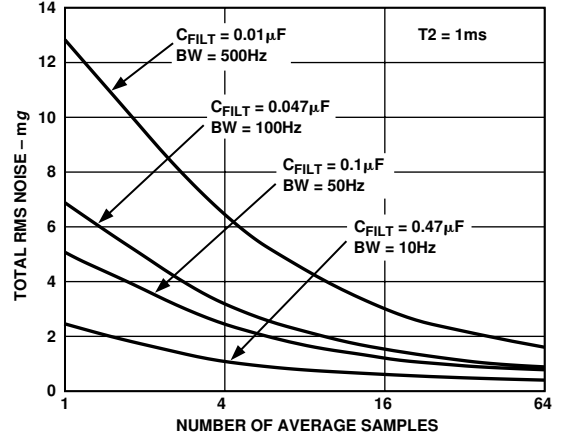

Figure 10. Typical Noise at Digital Outputs

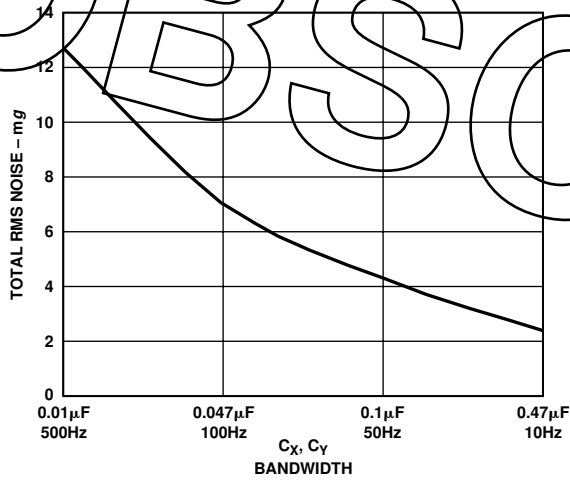

Figure 9. Typical Noise at X_{FILT} Output



Figure 11. Rotational Die Alignment

ADXL202/ADXL210

DEFINITIONS

- T1** Length of the “on” portion of the cycle.
- T2** Length of the total cycle.
- Duty Cycle** Ratio of the “on” time (T1) of the cycle to the total cycle (T2). Defined as T1/T2 for the ADXL202/ADXL210.
- Pulsewidth** Time period of the “on” pulse. Defined as T1 for the ADXL202/ADXL210.

THEORY OF OPERATION

The ADXL202/ADXL210 are complete dual axis acceleration measurement systems on a single monolithic IC. They contain a polysilicon surface-micromachined sensor and signal conditioning circuitry to implement an open loop acceleration measurement architecture. For each axis, an output circuit converts the analog signal to a duty cycle modulated (DCM) digital signal that can be decoded with a counter/timer port on a microprocessor. The ADXL202/ADXL210 are capable of measuring both positive and negative accelerations to a maximum level of $\pm 2 g$ or $\pm 10 g$. The accelerometer measures static acceleration forces such as gravity, allowing it to be used as a tilt sensor.

The sensor is a surface micromachined polysilicon structure built on top of the silicon wafer. Polysilicon springs suspend the structure over the surface of the wafer and provide a resistance against acceleration forces. Deflection of the structure is measured using a differential capacitor that consists of independent fixed plates and central plates attached to the moving mass. The fixed plates are driven by 180° out of phase square waves. An acceleration will deflect the beam and unbalance the differential capacitor, resulting in an output square wave whose amplitude is proportional to acceleration. Phase sensitive demodulation techniques are then used to rectify the signal and determine the direction of the acceleration.

The output of the demodulator drives a duty cycle modulator (DCM) stage through a 32 k Ω resistor. At this point a pin is available on each channel to allow the user to set the signal bandwidth of the device by adding a capacitor. This filtering improves measurement resolution and helps prevent aliasing.

After being low-pass filtered, the analog signal is converted to a duty cycle modulated signal by the DCM stage. A single resistor sets the period for a complete cycle (T2), which can be set between 0.5 ms and 10 ms (see Figure 12). A 0 g acceleration produces a nominally 50% duty cycle. The acceleration signal can be determined by measuring the length of the T1 and T2 pulses with a counter/timer or with a polling loop using a low cost microcontroller.

An analog output voltage can be obtained either by buffering the signal from the X_{FILT} and Y_{FILT} pin, or by passing the duty cycle signal through an RC filter to reconstruct the dc value.

The ADXL202/ADXL210 will operate with supply voltages as low as 3.0 V or as high as 5.25 V.

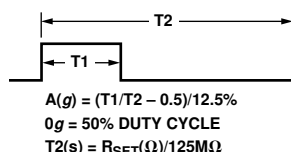

Figure 12. Typical Output Duty Cycle

APPLICATIONS

POWER SUPPLY DECOUPLING

For most applications a single 0.1 μF capacitor, C_{DC}, will adequately decouple the accelerometer from signal and noise on the power supply. However, in some cases, especially where digital devices such as microcontrollers share the same power supply, digital noise on the supply may cause interference on the ADXL202/ADXL210 output. This is often observed as a slowly undulating fluctuation of voltage at X_{FILT} and Y_{FILT}. If additional decoupling is needed, a 100 Ω (or smaller) resistor or ferrite beads, may be inserted in the ADXL202/ADXL210's supply line.

DESIGN PROCEDURE FOR THE ADXL202/ADXL210

The design procedure for using the ADXL202/ADXL210 with a duty cycle output involves selecting a duty cycle period and a filter capacitor. A proper design will take into account the application requirements for bandwidth, signal resolution and acquisition time, as discussed in the following sections.

V_{DD}

The ADXL202/ADXL210 have two power supply (V_{DD}) Pins: 13 and 14. These two pins should be connected directly together.

COM

The ADXL202/ADXL210 have two commons, Pins 4 and 7. These two pins should be connected directly together and Pin 7 grounded.

V_{TT}

This pin is to be left open; make no connections of any kind to this pin.

Decoupling Capacitor C_{DC}

A 0.1 μF capacitor is recommended from V_{DD} to COM for power supply decoupling.

ST

The ST pin controls the self-test feature. When this pin is set to V_{DD}, an electrostatic force is exerted on the beam of the accelerometer. The resulting movement of the beam allows the user to test if the accelerometer is functional. The typical change in output will be 10% at the duty cycle outputs (corresponding to 800 mg). This pin may be left open circuit or connected to common in normal use.

Duty Cycle Decoding

The ADXL202/ADXL210's digital output is a duty cycle modulator. Acceleration is proportional to the ratio T1/T2. The nominal output of the ADXL202 is:

$$0 g = 50\% \text{ Duty Cycle}$$

Scale factor is 12.5% Duty Cycle Change per g

The nominal output of the ADXL210 is:

$$0 g = 50\% \text{ Duty Cycle}$$

Scale factor is 4% Duty Cycle Change per g

These nominal values are affected by the initial tolerance of the device including zero g offset error and sensitivity error.

T2 does not have to be measured for every measurement cycle. It need only be updated to account for changes due to temperature, (a relatively slow process). Since the T2 time period is shared by both X and Y channels, it is necessary only to measure it on one channel of the ADXL202/ADXL210. Decoding algorithms for various microcontrollers have been developed. Consult the appropriate Application Note.

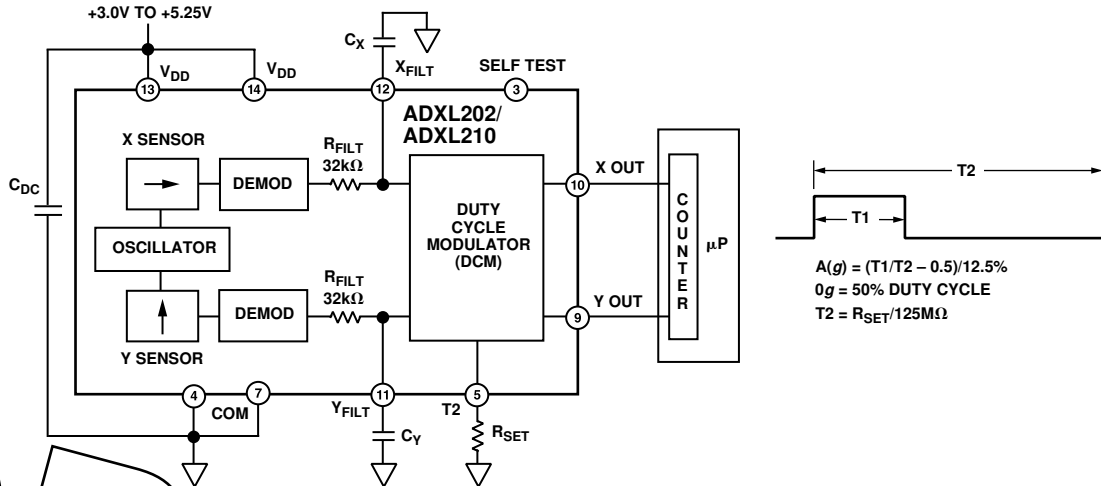

Figure 13. Block Diagram

Setting the Bandwidth Using C_x and C_y

The ADXL202/ADXL210 have provisions for bandlimiting the X_{FILT} and Y_{FILT} pins. Capacitors must be added at these pins to implement low-pass filtering for antialiasing and noise reduction. The equation for the 3 dB bandwidth is:

$$F_{-3dB} = \frac{1}{(2 \pi (32 \text{ k}\Omega) \times C(x, y))}$$

or, more simply, $F_{-3dB} = \frac{5 \mu F}{C_{(X,Y)}}$

The tolerance of the internal resistor (R_{FILT}), can vary as much as $\pm 25\%$ of its nominal value of 32 k Ω ; so the bandwidth will vary accordingly. A minimum capacitance of 1000 pF for $C_{(X,Y)}$ is required in all cases.

Table I. Filter Capacitor Selection, C_x and C_y

Bandwidth	Capacitor Value
10 Hz	0.47 μF
50 Hz	0.10 μF
100 Hz	0.05 μF
200 Hz	0.027 μF
500 Hz	0.01 μF
5 kHz	0.001 μF

Setting the DCM Period with R_{SET}

The period of the DCM output is set for both channels by a single resistor from R_{SET} to ground. The equation for the period is:

$$T2 = \frac{R_{SET} (\Omega)}{125 \text{ M}\Omega}$$

A 125 k Ω resistor will set the duty cycle repetition rate to approximately 1 kHz, or 1 ms. The device is designed to operate at duty cycle periods between 0.5 ms and 10 ms.

Table II. Resistor Values to Set $T2$

$T2$	R_{SET}
1 ms	125 k Ω
2 ms	250 k Ω
5 ms	625 k Ω
10 ms	1.25 M Ω

Note that the R_{SET} should always be included, even if only an analog output is desired. Use an R_{SET} value between 500 k Ω and 2 M Ω when taking the output from X_{FILT} or Y_{FILT} . The R_{SET} resistor should be placed close to the $T2$ pin to minimize parasitic capacitance at this node.

Selecting the Right Accelerometer

For most tilt sensing applications the ADXL202 is the most appropriate accelerometer. Its higher sensitivity (12.5%/g allows the user to use a lower speed counter for PWM decoding while maintaining high resolution. The ADXL210 should be used in applications where accelerations of greater than $\pm 2 g$ are expected.

MICROCOMPUTER INTERFACES

The ADXL202/ADXL210 were specifically designed to work with low cost microcontrollers. Specific code sets, reference designs, and application notes are available from the factory. This section will outline a general design procedure and discuss the various trade-offs that need to be considered.

The designer should have some idea of the required performance of the system in terms of:

Resolution: the smallest signal change that needs to be detected.

Bandwidth: the highest frequency that needs to be detected.

Acquisition Time: the time that will be available to acquire the signal on each axis.

These requirements will help to determine the accelerometer bandwidth, the speed of the microcontroller clock and the length of the $T2$ period.

When selecting a microcontroller it is helpful to have a counter timer port available. The microcontroller should have provisions for software calibration. While the ADXL202/ADXL210 are highly accurate accelerometers, they have a wide tolerance for

ADXL202/ADXL210

initial offset. The easiest way to null this offset is with a calibration factor saved on the microcontroller or by a user calibration for zero g . In the case where the offset is calibrated during manufacture, there are several options, including external EEPROM and microcontrollers with “one-time programmable” features.

DESIGN TRADE-OFFS FOR SELECTING FILTER CHARACTERISTICS: THE NOISE/BW TRADE-OFF

The accelerometer bandwidth selected will determine the measurement resolution (smallest detectable acceleration). Filtering can be used to lower the noise floor and improve the resolution of the accelerometer. Resolution is dependent on both the analog filter bandwidth at X_{FILT} and Y_{FILT} and on the speed of the microcontroller counter.

The analog output of the ADXL202/ADXL210 has a typical bandwidth of 5 kHz, much higher than the duty cycle stage is capable of converting. The user must filter the signal at this point to limit aliasing errors. To minimize DCM errors the analog bandwidth should be less than 1/10 the DCM frequency. Analog bandwidth may be increased to up to 1/2 the DCM frequency in many applications. This will result in greater dynamic error generated at the DCM.

The analog bandwidth may be further decreased to reduce noise and improve resolution. The ADXL202/ADXL210 noise has the characteristics of white Gaussian noise that contributes equally at all frequencies and is described in terms of μg per root Hz; i.e., the noise is proportional to the square root of the bandwidth of the accelerometer. It is recommended that the user limit bandwidth to the lowest frequency needed by the application, to maximize the resolution and dynamic range of the accelerometer.

With the single pole roll-off characteristic, the typical noise of the ADXL202/ADXL210 is determined by the following equation:

$$Noise (rms) = \left(500 \mu g / \sqrt{Hz} \right) \times \left(\sqrt{BW \times 1.5} \right)$$

At 100 Hz the noise will be:

$$Noise (rms) = \left(500 \mu g / \sqrt{Hz} \right) \times \left(\sqrt{100 \times (1.5)} \right) = 6.12 mg$$

Often the peak value of the noise is desired. Peak-to-peak noise can only be estimated by statistical methods. Table III is useful for estimating the probabilities of exceeding various peak values, given the rms value.

Table III. Estimation of Peak-to-Peak Noise

Nominal Peak-to-Peak Value	% of Time that Noise Will Exceed Nominal Peak-to-Peak Value
2.0 × rms	32%
4.0 × rms	4.6%
6.0 × rms	0.27%
8.0 × rms	0.006%

The peak-to-peak noise value will give the best estimate of the uncertainty in a single measurement.

Table IV gives typical noise output of the ADXL202/ADXL210 for various C_X and C_Y values.

Table IV. Filter Capacitor Selection, C_X and C_Y

Bandwidth	C_X, C_Y	rms Noise	Peak-to-Peak Noise Estimate 95% Probability (rms × 4)
10 Hz	0.47 μF	1.9 mg	7.6 mg
50 Hz	0.10 μF	4.3 mg	17.2 mg
100 Hz	0.05 μF	6.1 mg	24.4 mg
200 Hz	0.027 μF	8.7 mg	35.8 mg
500 Hz	0.01 μF	13.7 mg	54.8 mg

CHOOSING T2 AND COUNTER FREQUENCY: DESIGN TRADE-OFFS

The noise level is one determinant of accelerometer resolution. The second relates to the measurement resolution of the counter when decoding the duty cycle output.

The ADXL202/ADXL210's duty cycle converter has a resolution of approximately 14 bits; better resolution than the accelerometer itself. The actual resolution of the acceleration signal is, however, limited by the time resolution of the counting devices used to decode the duty cycle. The faster the counter clock, the higher the resolution of the duty cycle and the shorter the T2 period can be for a given resolution. The following table shows some of the trade-offs. It is important to note that this is the resolution due to the microprocessors' counter. It is probable that the accelerometer's noise floor may set the lower limit on the resolution, as discussed in the previous section.

Table V. Trade-Offs Between Microcontroller Counter Rate, T2 Period and Resolution of Duty Cycle Modulator

T2 (ms)	R_{SET} (k Ω)	ADXL202/ADXL210 Sample Rate	Counter-Clock Rate (MHz)	Counts per T2 Cycle	Counts per g	Resolution (mg)
1.0	124	1000	2.0	2000	250	4.0
1.0	124	1000	1.0	1000	125	8.0
1.0	124	1000	0.5	500	62.5	16.0
5.0	625	200	2.0	10000	1250	0.8
5.0	625	200	1.0	5000	625	1.6
5.0	625	200	0.5	2500	312.5	3.2
10.0	1250	100	2.0	20000	2500	0.4
10.0	1250	100	1.0	10000	1250	0.8
10.0	1250	100	0.5	5000	625	1.6

STRATEGIES FOR USING THE DUTY CYCLE OUTPUT WITH MICROCONTROLLERS

Application notes outlining various strategies for using the duty cycle output with low cost microcontrollers are available from the factory.

USING THE ADXL202/ADXL210 AS A DUAL AXIS TILT SENSOR

One of the most popular applications of the ADXL202/ADXL210 is tilt measurement. An accelerometer uses the force of gravity as an input vector to determine orientation of an object in space.

An accelerometer is most sensitive to tilt when its sensitive axis is perpendicular to the force of gravity, i.e., parallel to the earth's surface. At this orientation its sensitivity to changes in tilt is highest. When the accelerometer is oriented on axis to gravity, i.e., near its +1 g or -1 g reading, the change in output acceleration per degree of tilt is negligible. When the accelerometer is perpendicular to gravity, its output will change nearly 17.5 mg per degree of tilt, but at 45° degrees it is changing only at 12.2 mg per degree and resolution declines. The following table illustrates the changes in the X and Y axes as the device is tilted ±90° through gravity.

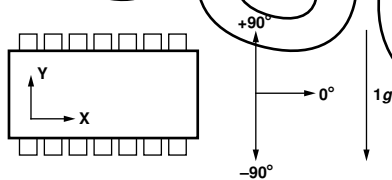

X AXIS ORIENTATION TO HORIZON (°)	X OUTPUT		Y OUTPUT (g)	
	X OUTPUT (g)	Δ PER DEGREE OF TILT (mg)	Y OUTPUT (g)	Δ PER DEGREE OF TILT (mg)
-90	-1.000	-0.2	0.000	17.5
-75	-0.966	4.4	0.259	16.9
-60	-0.866	8.6	0.500	15.2
-45	-0.707	12.2	0.707	12.4
-30	-0.500	15.0	0.866	8.9
-15	-0.259	16.8	0.966	4.7
0	0.000	17.5	1.000	0.2
15	0.259	16.9	0.966	-4.4
30	0.500	15.2	0.866	-8.6
45	0.707	12.4	0.707	-12.2
60	0.866	8.9	0.500	-15.0
75	0.966	4.7	0.259	-16.8
90	1.000	0.2	0.000	-17.5

Figure 14. How the X and Y Axes Respond to Changes in Tilt

A DUAL AXIS TILT SENSOR: CONVERTING ACCELERATION TO TILT

When the accelerometer is oriented so both its X and Y axes are parallel to the earth's surface it can be used as a two axis tilt sensor with a roll and a pitch axis. Once the output signal from the accelerometer has been converted to an acceleration that varies between -1 g and +1 g, the output tilt in degrees is calculated as follows:

$$\text{Pitch} = \text{ASIN} (Ax/1 g)$$

$$\text{Roll} = \text{ASIN} (Ay/1 g)$$

Be sure to account for overranges. It is possible for the accelerometers to output a signal greater than ±1 g due to vibration, shock or other accelerations.

MEASURING 360° OF TILT

It is possible to measure a full 360° of orientation through gravity by using two accelerometers oriented perpendicular to one another (see Figure 15). When one sensor is reading a maximum change in output per degree, the other is at its minimum.

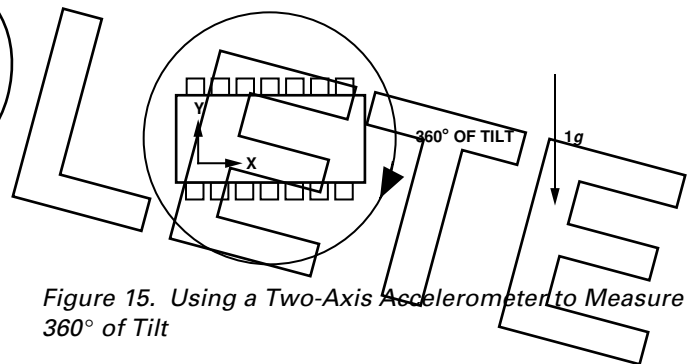

Figure 15. Using a Two-Axis Accelerometer to Measure 360° of Tilt

ADXL202/ADXL210

USING THE ANALOG OUTPUT

The ADXL202/ADXL210 was specifically designed for use with its digital outputs, but has provisions to provide analog outputs as well.

Duty Cycle Filtering

An analog output can be reconstructed by filtering the duty cycle output. This technique requires only passive components. The duty cycle period (T_2) should be set to 1 ms. An RC filter with a 3 dB point at least a factor of 10 less than the duty cycle frequency is connected to the duty cycle output. The filter resistor should be no less than 100 k Ω to prevent loading of the output stage. The analog output signal will be ratiometric to the supply voltage. The advantage of this method is an output scale factor of approximately double the analog output. Its disadvantage is that the frequency response will be lower than when using the X_{FILT} , Y_{FILT} output.

X_{FILT} , Y_{FILT} Output

The second method is to use the analog output present at the X_{FILT} and Y_{FILT} pin. Unfortunately, these pins have a 32 k Ω output impedance and are not designed to drive a load directly. An op amp follower may be required to buffer this pin. The advantage of this method is that the full 5 kHz bandwidth of the accelerometer is available to the user. A capacitor still must be added at this point for filtering. The duty cycle converter should be kept running by using $R_{SET} < 10 M\Omega$. Note that the accelerometer offset and sensitivity are ratiometric to the supply voltage. The offset and sensitivity are nominally:

$$\begin{aligned} 0\text{ g Offset} &= V_{DD}/2 && 2.5\text{ V at } +5\text{ V} \\ \text{ADXL202 Sensitivity} &= (60\text{ mV} \times V_S)/g && 300\text{ mV/g at } +5\text{ V, } V_{DD} \\ \text{ADXL210 Sensitivity} &= (20\text{ mV} \times V_S)/g && 100\text{ mV/g at } +5\text{ V, } V_{DD} \end{aligned}$$

USING THE ADXL202/ADXL210 IN VERY LOW POWER APPLICATIONS

An application note outlining low power strategies for the ADXL202/ADXL210 is available. Some key points are presented here. It is possible to reduce the ADXL202/ADXL210's average current from 0.6 mA to less than 20 μ A by using the following techniques:

1. Power Cycle the accelerometer.
2. Run the accelerometer at a Lower Voltage, (Down to 3 V).

Power Cycling with an External A/D

Depending on the value of the X_{FILT} capacitor, the ADXL202/ADXL210 is capable of turning on and giving a good reading in 1.6 ms. Most microcontroller based A/Ds can acquire a reading in another 25 μ s. Thus it is possible to turn on the ADXL202/ADXL210 and take a reading in < 2 ms. If we assume that a 20 Hz sample rate is sufficient, the total current required to take 20 samples is $2\text{ ms} \times 20\text{ samples/s} \times 0.6\text{ mA} = 24\text{ }\mu\text{A}$ average current. Running the part at 3 V will reduce the supply current from 0.6 mA to 0.4 mA, bringing the average current down to 16 μ A.

The A/D should read the analog output of the ADXL202/ADXL210 at the X_{FILT} and Y_{FILT} pins. A buffer amplifier is recommended, and may be required in any case to amplify the analog output to give enough resolution with an 8-bit to 10-bit converter.

Power Cycling When Using the Digital Output

An alternative is to run the microcontroller at a higher clock rate and put it into shutdown between readings, allowing the use of the digital output. In this approach the ADXL202/ADXL210 should be set at its fastest sample rate ($T_2 = 0.5\text{ ms}$), with a 500 Hz filter at X_{FILT} and Y_{FILT} . The concept is to acquire a reading as quickly as possible and then shut down the ADXL202/ADXL210 and the microcontroller until the next sample is needed.

In either of the above approaches, the ADXL202/ADXL210 can be turned on and off directly using a digital port pin on the microcontroller to power the accelerometer without additional components. The port should be used to switch the common pin of the accelerometer so the port pin is "pulling down."

CALIBRATING THE ADXL202/ADXL210

The initial value of the offset and scale factor for the ADXL202/ADXL210 will require calibration for applications such as tilt measurement. The ADXL202/ADXL210 architecture has been designed so that these calibrations take place in the software of the microcontroller used to decode the duty cycle signal. Calibration factors can be stored in EEPROM or determined at turn-on and saved in dynamic memory.

For low g applications, the force of gravity is the most stable, accurate and convenient acceleration reference available. A reading of the 0 g point can be determined by orientating the device parallel to the earth's surface and then reading the output.

A more accurate calibration method is to make a measurements at +1 g and -1 g . The sensitivity can be determined by the two measurements.

To calibrate, the accelerometer's measurement axis is pointed directly at the earth. The 1 g reading is saved and the sensor is turned 180° to measure -1 g . Using the two readings, the sensitivity is:

$$\begin{aligned} \text{Let } A &= \text{Accelerometer output with axis oriented to } +1\text{ g} \\ \text{Let } B &= \text{Accelerometer output with axis oriented to } -1\text{ g then:} \\ \text{Sensitivity} &= [A - B]/2\text{ g} \end{aligned}$$

For example, if the +1 g reading (A) is 55% duty cycle and the -1 g reading (B) is 32% duty cycle, then:

$$\text{Sensitivity} = [55\% - 32\%]/2\text{ g} = 11.5\%/g$$

These equations apply whether the output is analog, or duty cycle.

Application notes outlining algorithms for calculating acceleration from duty cycle and automated calibration routines are available from the factory.

OUTLINE DIMENSIONS

Dimensions shown in inches and (mm).

**14-Lead CERPAK
(QC-14)**

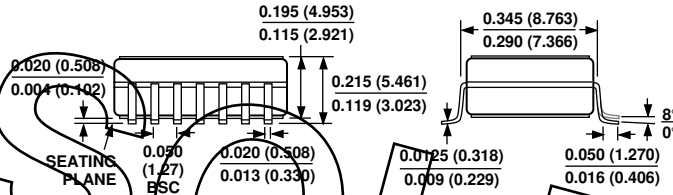
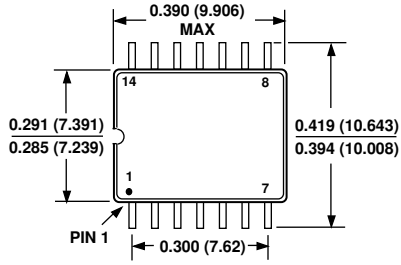

OBSOLETE