



Chipsmall Limited consists of a professional team with an average of over 10 year of expertise in the distribution of electronic components. Based in Hongkong, we have already established firm and mutual-benefit business relationships with customers from,Europe,America and south Asia,supplying obsolete and hard-to-find components to meet their specific needs.

With the principle of “Quality Parts,Customers Priority,Honest Operation,and Considerate Service”,our business mainly focus on the distribution of electronic components. Line cards we deal with include Microchip,ALPS,ROHM,Xilinx,Pulse,ON,Everlight and Freescale. Main products comprise IC,Modules,Potentiometer,IC Socket,Relay,Connector.Our parts cover such applications as commercial,industrial, and automotives areas.

We are looking forward to setting up business relationship with you and hope to provide you with the best service and solution. Let us make a better world for our industry!



Contact us

Tel: +86-755-8981 8866 Fax: +86-755-8427 6832

Email & Skype: info@chipsmall.com Web: www.chipsmall.com

Address: A1208, Overseas Decoration Building, #122 Zhenhua RD., Futian, Shenzhen, China



AEDR-872x

3-Channel Reflective Incremental Encoder (Analog Output)



Data Sheet

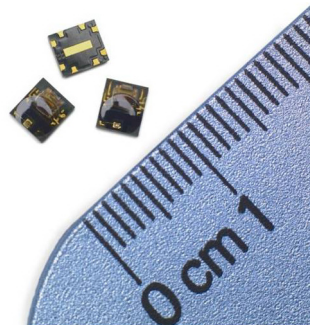

Description

The AEDR-872x encoder is a three-channel optical encoder with two channels differential analog and a third digital index output. The encoder is designed to operate over -20 °C to 85 °C temperature range and so is suitable for both commercial and industrial end applications.

The encoder houses an LED light source and photo-detecting circuitry in a single package. The small size of 3.95 mm (L) × 3.4 mm (W) × 0.9562 mm (H) allows it to be used even in a wide range of miniature commercial applications in which size and space is a primary concern.

The AEDR-872x encoder, with two channels differential analog outputs (Sin, /Sin, Cos, /Cos) can be interfaced directly with most of the external interpolators available. As such, the encoder provides great design-in flexibility and easy integration into existing systems.

Features

- Analog Output option: Two-channel differential analog output and with a digital index output
- Surface mount leadless package: 3.95 mm (L) × 3.4 mm (W) × 0.9562 mm (H)
- Operating voltage of 5.0 V supply
- Built-in LED current regulation, and so no external biasing resistor is needed
- -20 °C to 85 °C absolute operating temperature
- High encoding resolution: 318 (lines/inch, LPI)

Applications

Ideal for high volume applications:

- Closed-loop stepper motors
- Miniature motors
- Printers and copiers
- Card readers
- Scanners
- Projectors
- Portable medical equipment
- Optometric equipment
- Consumer and industrial product applications

Output Waveform

Analog Option

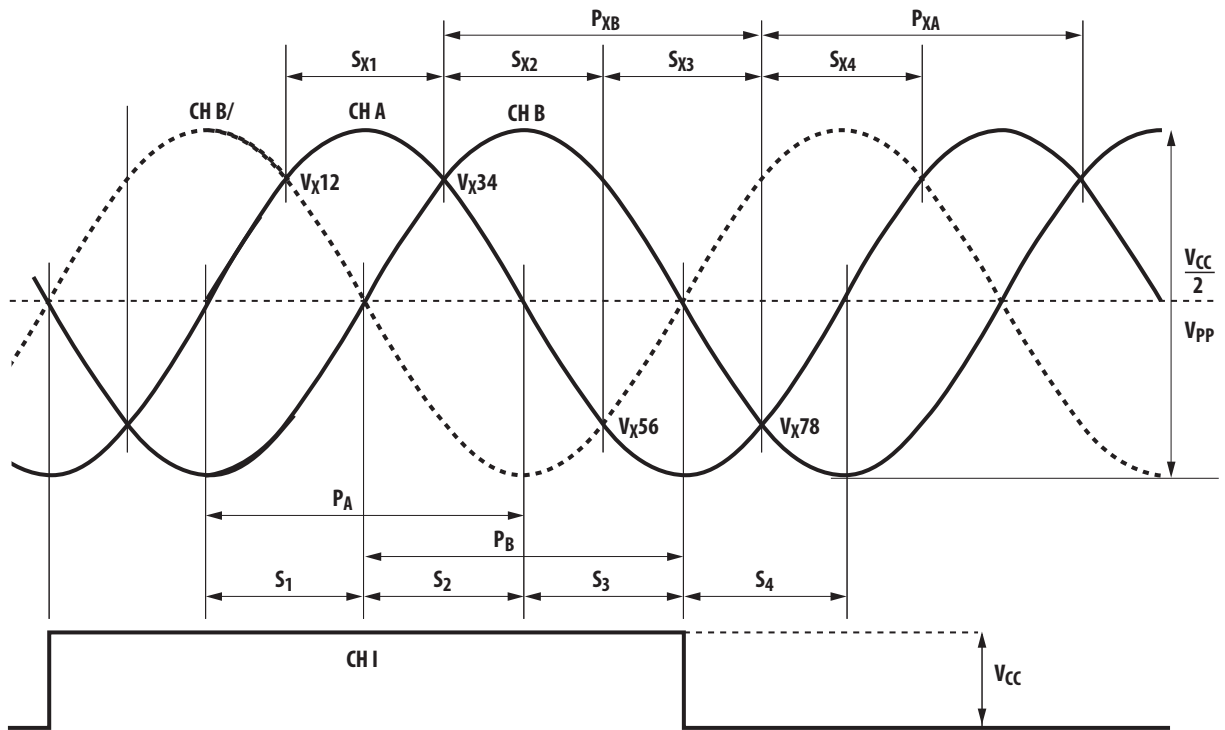

Codewheel rotation movement (anti-clockwise)

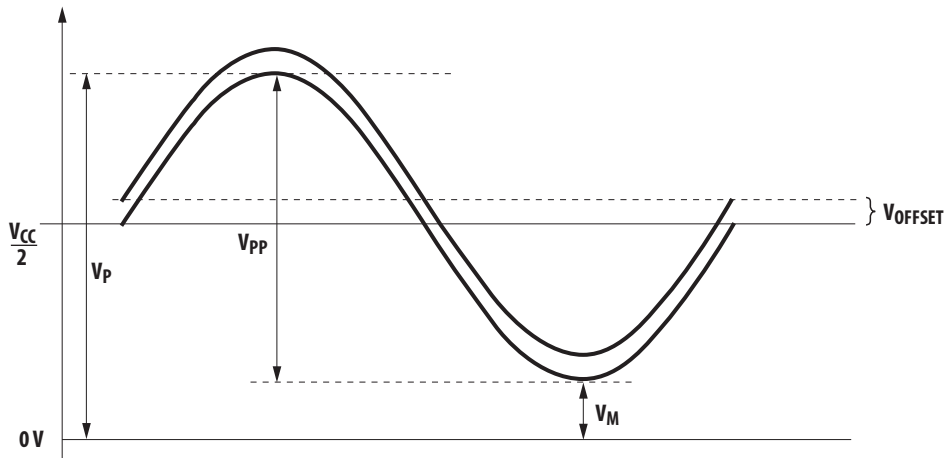

Test Parameter Definitions

Parameter	Symbol	Description
Analog Peak-to-Peak	V_{PP}	The peak-to-peak signal magnitude in V of the analog signal
Analog Offset	V_{OFFSET}	The offset in mV from the midpoint of the analog peak-to-peak signal to the zero voltage point
Analog Peak/Valley Voltage	$V_{PA}, V_{PB}, V_{MA}, V_{MB}$	The value in V of the peak or valley of the analog signal (that is, one-sided reading)
Analog Peak-to-Peak Voltage	V_{PPA}, V_{PPB}	The absolute difference between V_P and V_M of channel A or B
Analog Crosspoint Voltage	$V_{X12}, V_{X34}, V_{X56}, V_{X78}$	The intersections in V of channel A analog waveform with that of either channel B or its component
Analog Offset Voltage	$V_{OFFSETA}, V_{OFFSETB}$	The offset in mV from the midpoint of the analog peak-to-peak signal to 2.5 V

Absolute Maximum Ratings

Parameter	Value
Storage Temperature, T_S	-20 °C to 85 °C
Operating Temperature, T_A	-20 °C to 85 °C
Supply Voltage, V_{CC}	7 V

Notes:

1. Exposure to extreme light intensity (such as from flashbulbs or spotlights) may cause permanent damage to the device.
2. CAUTION: To avoid damage or degradation induced by ESD, take normal static precautions when handling the encoder.
3. Proper operation of the encoder cannot be guaranteed if the maximum ratings are exceeded.

Recommended Operating Conditions

Parameter	Symbol	Min.	Typ.	Max.	Units	Notes
Operating Temperature	T_A	-20	25	85	°C	
Supply Voltage	V_{CC}	4.5	5	5.5	V	Ripple < 100 mV _{p-p}
Current	I_{CC}	-	27	60	mA	
Max. Output Frequency	F	-	-	120	kHz	
Radial Misalignment	E_R	-	-	± 0.2	mm	
Tangential Misalignment	E_T	-	-	± 0.2	mm	
Codewheel Gap	G	0.5	0.75	1.0	mm	

Recommended Codewheel Characteristics

Parameter	Symbol	Min.	Max.	Unit	Notes
Window/Bar Ratio	W_W/W_B	0.9	1.1		
Window/Bar Length	L_W	1.80 (0.071)	-	mm (inches)	
Specular Reflectance	R_f	60	-		Reflective area ^[1]
		-	10		Non-reflective area
Line Density	LPmm	12.52		lines/mm	
	LPI	318		lines/inch	

Notes:

1. Measurements from TMA μ Scan meter
2. $LPmm = CPR/[2\pi \cdot R_{op}(mm)]$

Encoder Pinouts

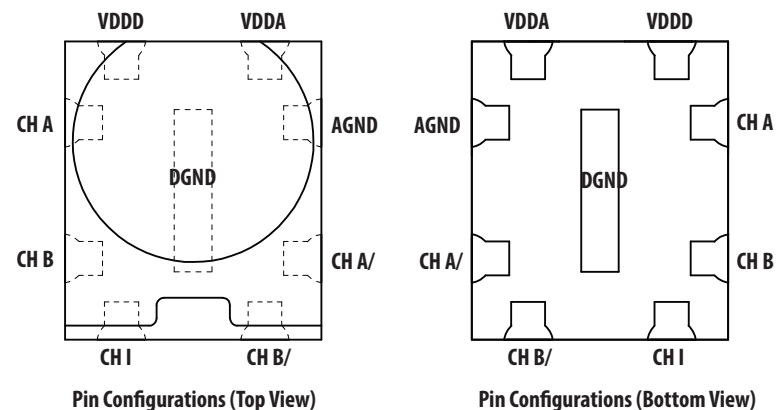

Recommended Setup For the Power Supply Pins

Connect both V_{DD} , V_{DDA} and their corresponding grounds (AGND and DGND) appropriately as follows. It is recommended that you use 22 μF and 0.1 μF for bypass capacitors on V_{DD} and V_{DDA} and place them in parallel as close as possible to the power and the ground pins. Do not run CH I in parallel and close to the trace of analog signals. Always keep the trace routing and cable to the minimum length.

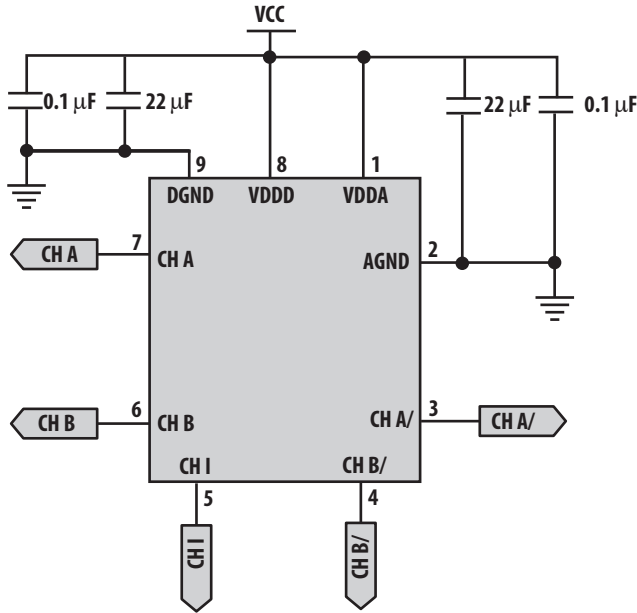

Note:

1. Pin 9 is the center pad of the package.

Encoding Characteristics

Parameter	Symbol	Min.	Typ.	Max.	Unit
Peak-to-Peak Voltage (Average)	V_{PPA}, V_{PPB}	0.9	1	1.1	V
Analog Offset Voltage	$V_{OFFSETA}, V_{OFFSETB}$	$0.45V_{CC}$	$0.5V_{CC}$	$0.55V_{CC}$	V
Voltage Reference (Midpoint of signal V_{pp})	V_{REF}	-	$V_{CC}/2$	-	V

Parameter	Symbol	Typ.	Unit
Index Pulse Width (Ungated)	I	430	$^{\circ}\text{e}$
State Width Error	ΔS	± 8	$^{\circ}\text{e}$
Pulse Width Error	ΔP	± 12	$^{\circ}\text{e}$
State X Width Error	ΔS_x	± 5	$^{\circ}\text{e}$
Pulse X Width Error	ΔP_x	± 5	$^{\circ}\text{e}$

Notes:

1. Typical values represent the average values of encoder performance in our factory-based setup conditions.
2. The optimal performance of the encoder depends on the motor/system setup condition of the individual customer.

Codewheel Design Guideline

The index bar (I-) track is opaque and the width is $3 \times W_B^\circ$. The Index (I) track is reflective and the width is $3 \times W_W^\circ$. The dimension L_W should be at least 1.8 mm. (Note: If L_W shorter than 1.8 mm is required, please consult factory) There are 6 pairs of incremental track (1 pair= $1 W_B^\circ$ and $1 W_W^\circ$) between opaque and reflective index tracks.

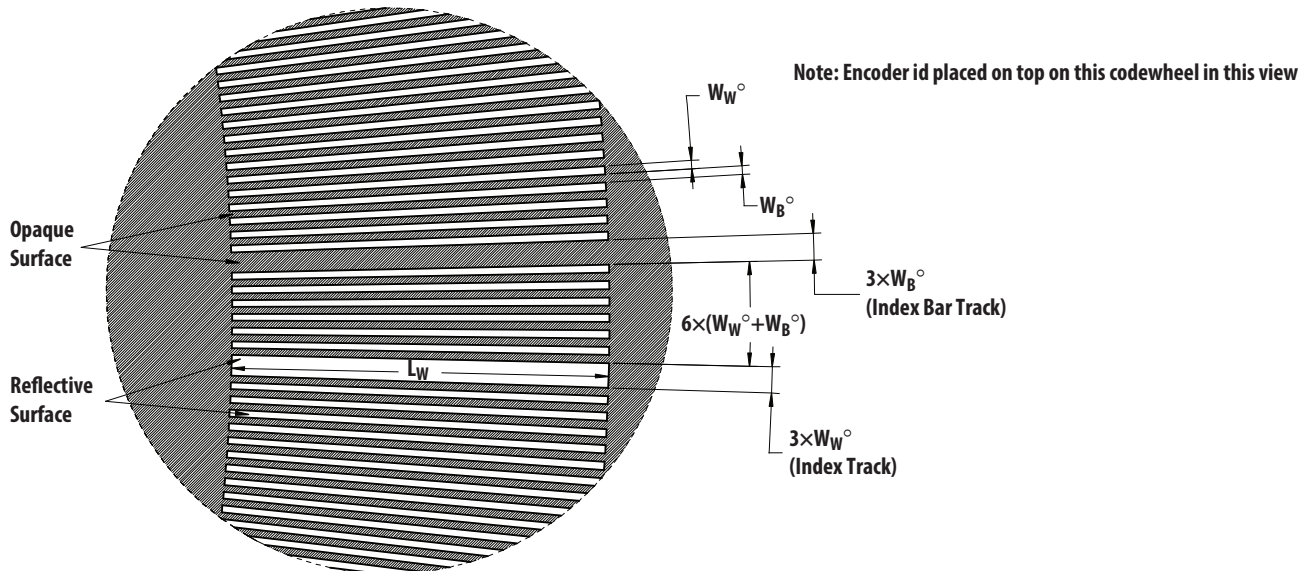

Codewheel design example

The following demonstrates a codewheel design for R_{op} of 11 mm @ 865 CPR for a 2-channel and a 3-channel encoder.

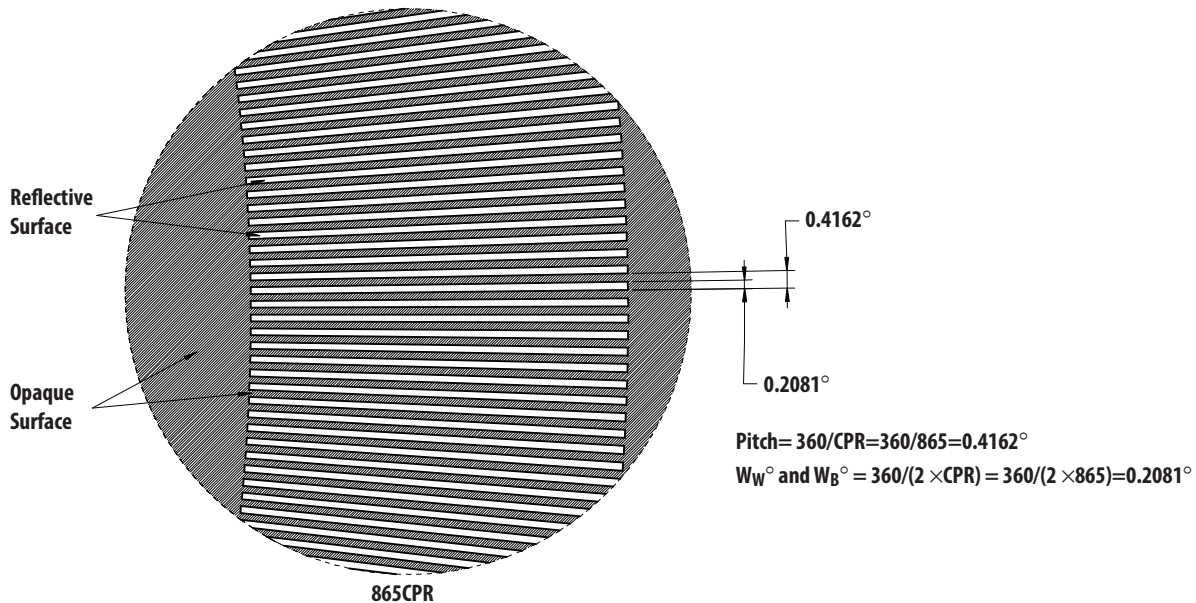

Codewheel pattern for a 2-channel encoder

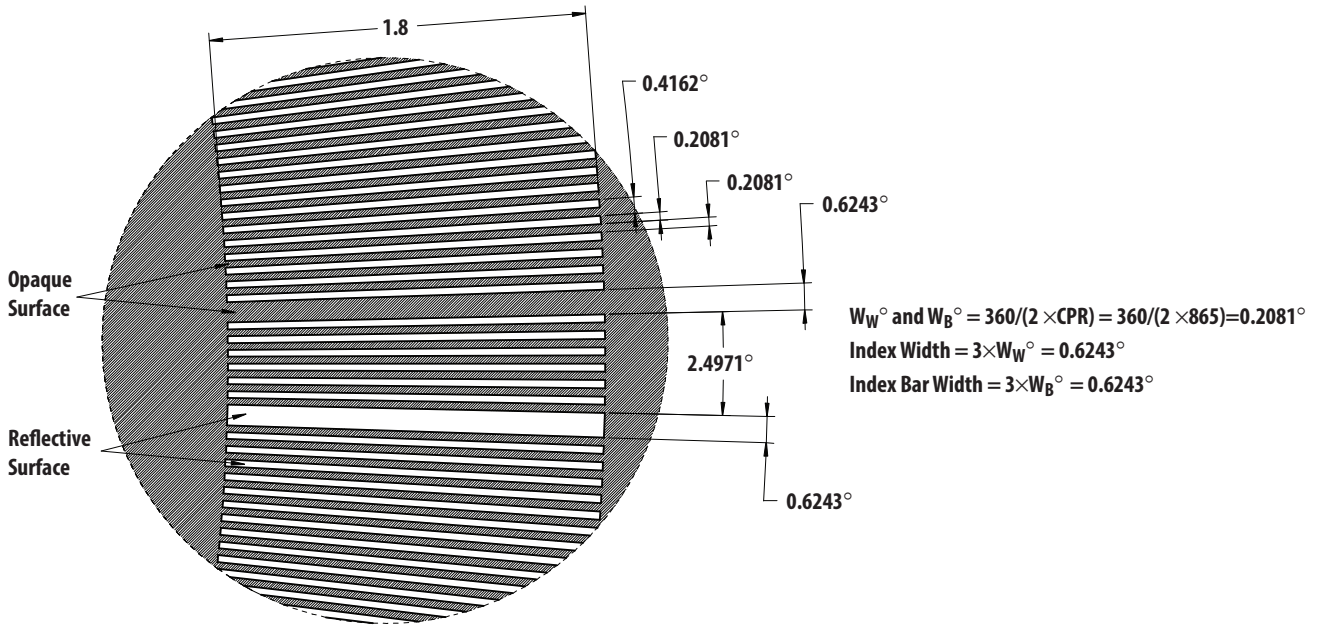

Codewheel pattern for a 3-channel encoder

Note: The overall physical track count is reduced but not the counts per revolution (CPR). The *CPR remains the same* because the count during this index transition is generated by an intelligent signal processing circuit.

Package Outline Drawing

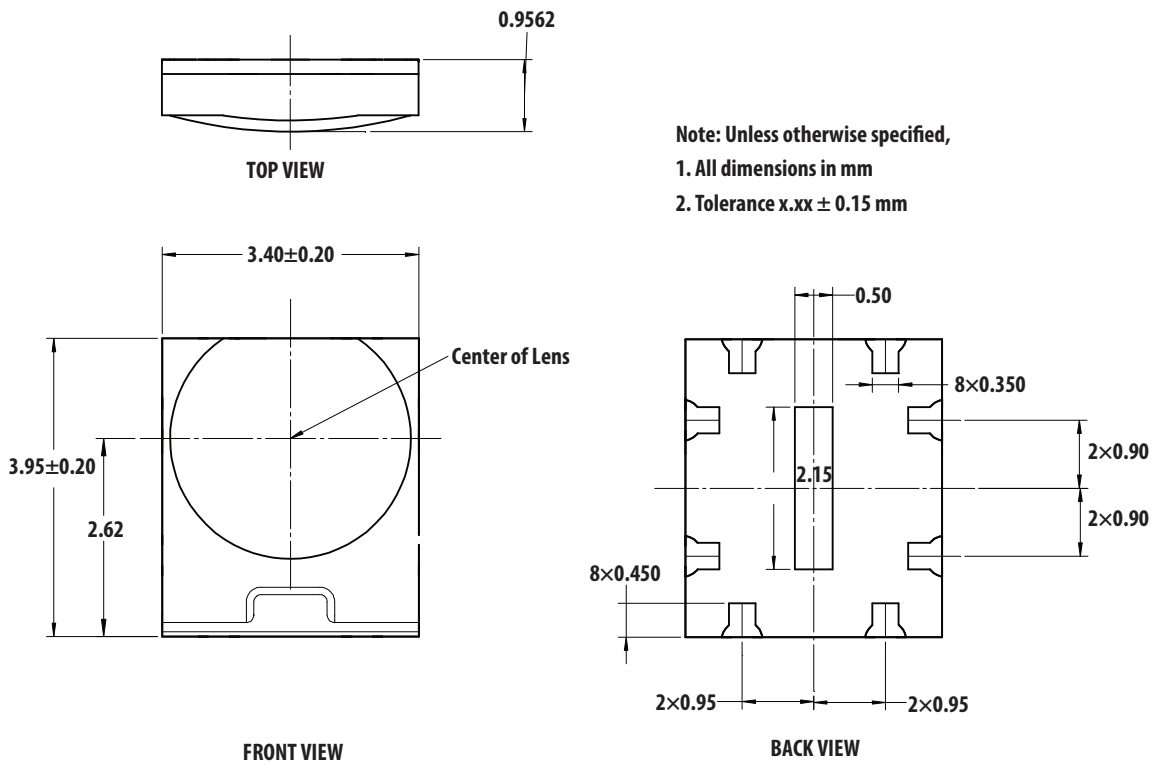

Recommended Land Pattern

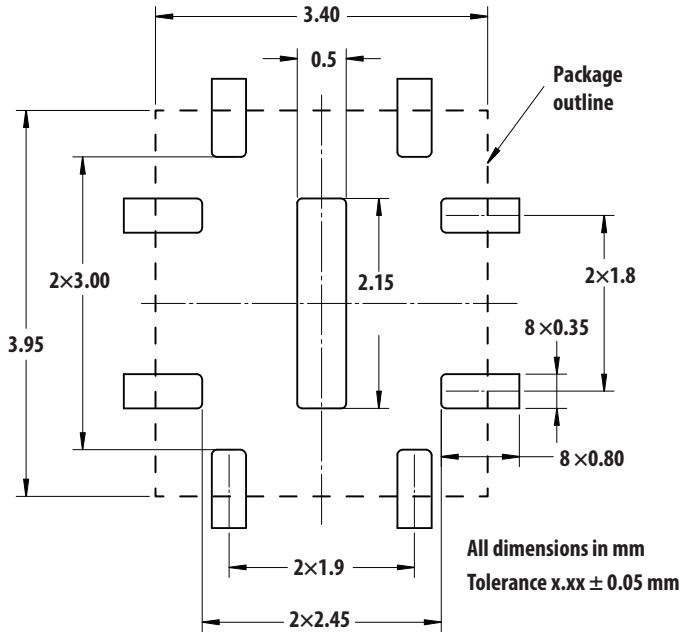

Encoder Placement Orientation and Positioning

The AEDR-872x is designed such that both the emitter and the detector ICs are placed parallel to the window/bar orientation, with the encoder mounted on top of the codewheel (see below right). When properly oriented, the detector side will be closer to the center of codewheel than the emitter. More importantly, the center of the lens of the encoder unit must be aligned with the codewheel (R_{OP}), or more specifically tangential to the center point of L_W (1/2 of the length of window).

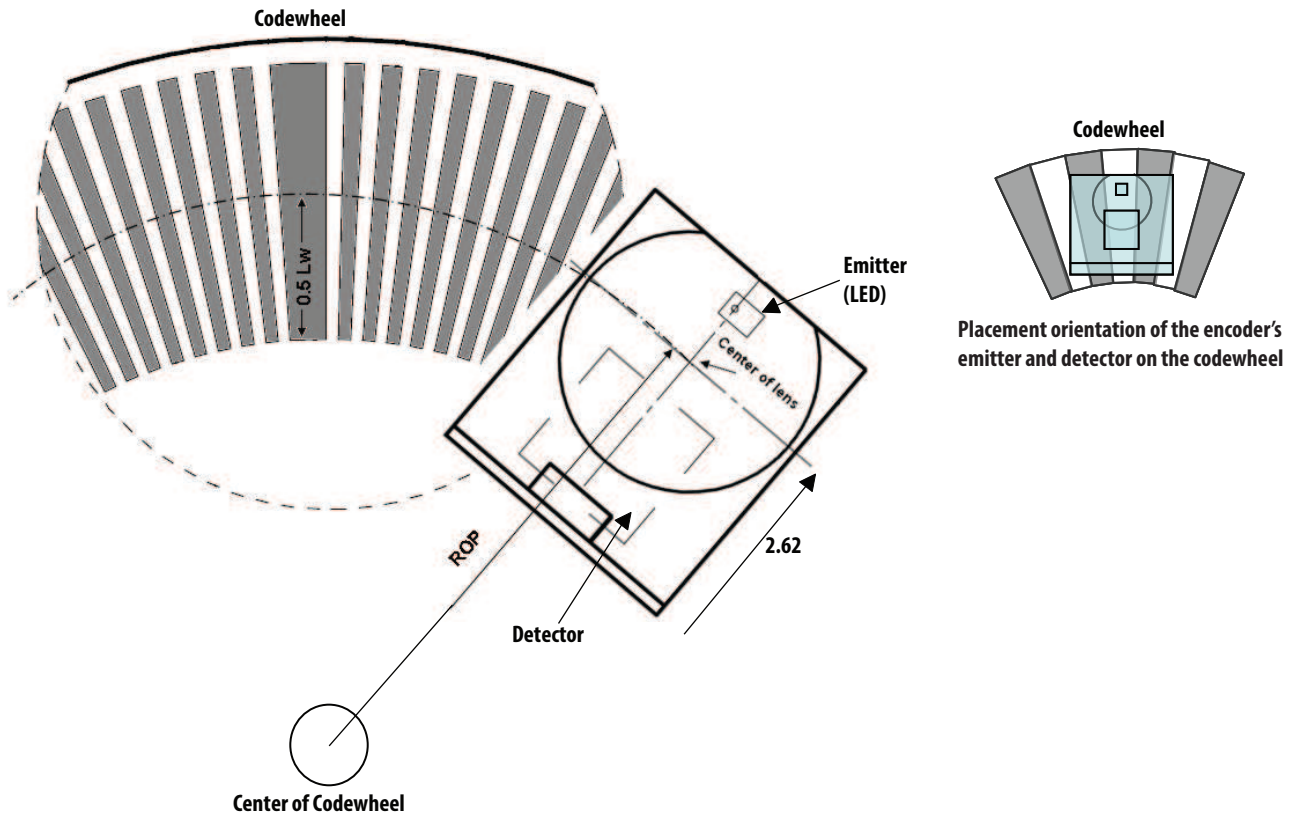

Direction of Movement

With the detector side of the encoder placed closer to the codewheel (see picture on the previous page), Channel A leads Channel B when the codewheel rotates anti-clockwise and vice versa (*with the encoder mounted on top of the codewheel*). The optimal gap setting recommended is between 0.5 to 1.0 mm (see the side view below).

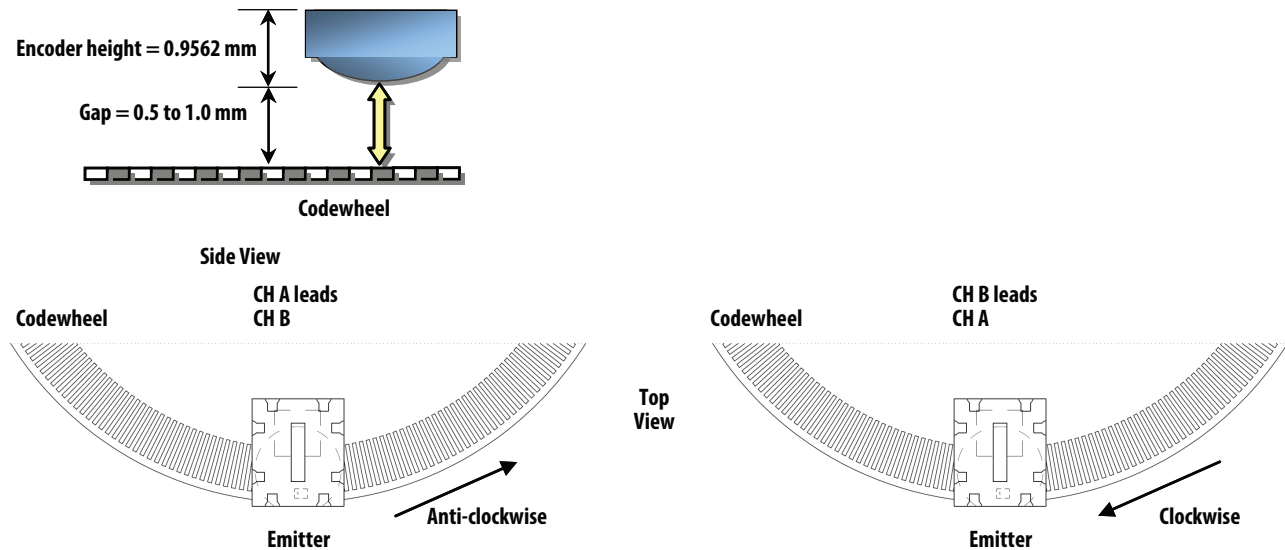

Note: Drawing not to scale

Moisture Sensitivity Level

The AEDR-872x is specified to Moisture Sensitive Level (MSL) 3. Precaution is required to handle this moisture-sensitive product to ensure the reliability of the product.

Storage before use

- An unopened Moisture Barrier Bag (MBB) can be stored at $< 40\text{ }^{\circ}\text{C}/90\% \text{ RH}$ for 12 months.
- It is not recommended that the MBB is opened before assembly.

Control after the MBB is opened

- Encoder that will be subjected to reflow solder must be mounted within 168 hours of factory condition $< 30\text{ }^{\circ}\text{C}/60\% \text{ RH}$

Control for unfinished reel

- Stored and sealed MBB with desiccant or desiccators at $< 5\% \text{ RH}$.

Baking is required if:

- Humidity Indicator Card (HIC) is $> 10\%$ when read at $23 \pm 5\text{ }^{\circ}\text{C}$
- The encoder floor life exceeded 168 hours.
- Recommended baking condition: $60 \pm 5\text{ }^{\circ}\text{C}$ for 20 hours (tape and reel), $125 \pm 5\text{ }^{\circ}\text{C}$ for 5 hours (loose unit)

Recommended Lead-free Reflow Soldering Temperature Profile

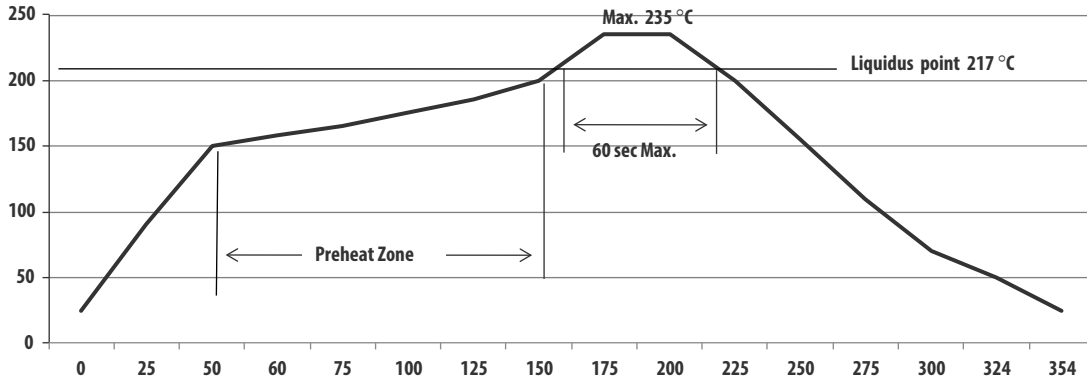

Average ramp up rate	= 3 °C/sec
Average ramp down rate	= 6 °C/sec
Preheat temperature	= 150 °C to 200 °C
Preheat time	= 60 to 100 sec
Time maintain above 217 °C	= 40 to 60 sec
Peak Temperature	= 235 °C
Time within 5 °C of peak temperature	= 20 to 30 sec

Notes:

1. Reflow with peak temperature > 235 °C may damage the component.
2. Due to treatment of high temperature, this clear compound may turn yellow after IR reflow.
3. Profile shown here is the actual readings from the thermocouple (attached to AEDR-872x as shown to the right) on the reflow board PCB.

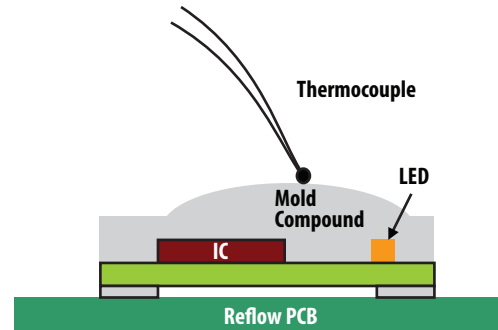

Tape and Reel Information

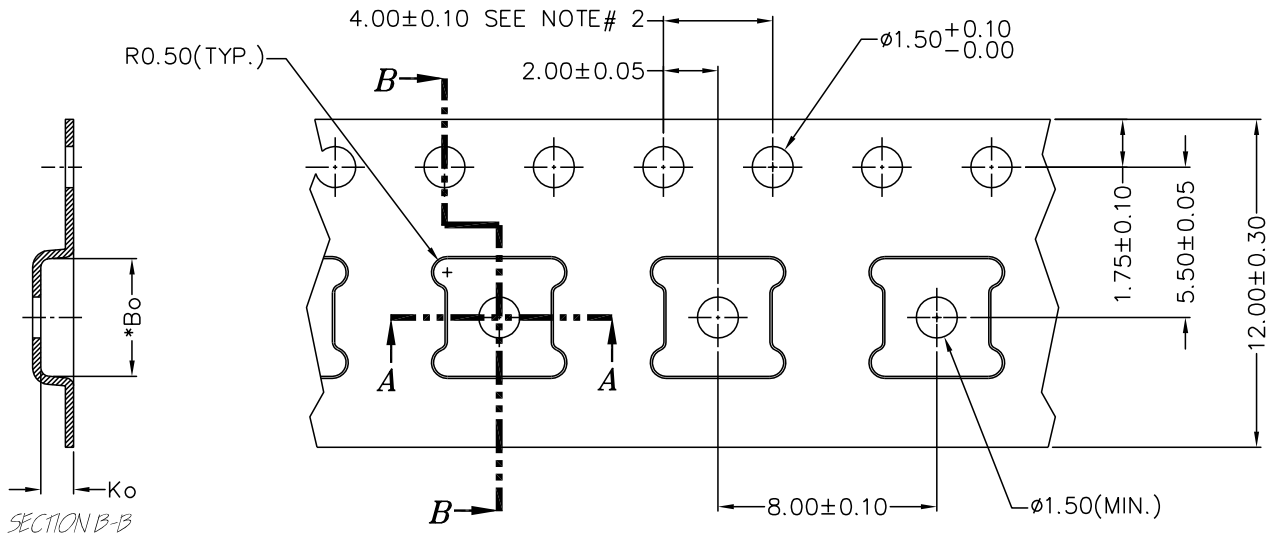

NOTES: -

1. * Ao & Bo measured at 0.3mm above base of pocket.
2. 10 pitches cumulative tol. ±0.2mm.
3. () Reference dimensions only.

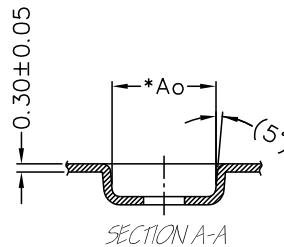

Ao:	3.80
Bo:	4.30
Ko:	1.20
Pitch:	8.00
Width:	12.00

Order Information

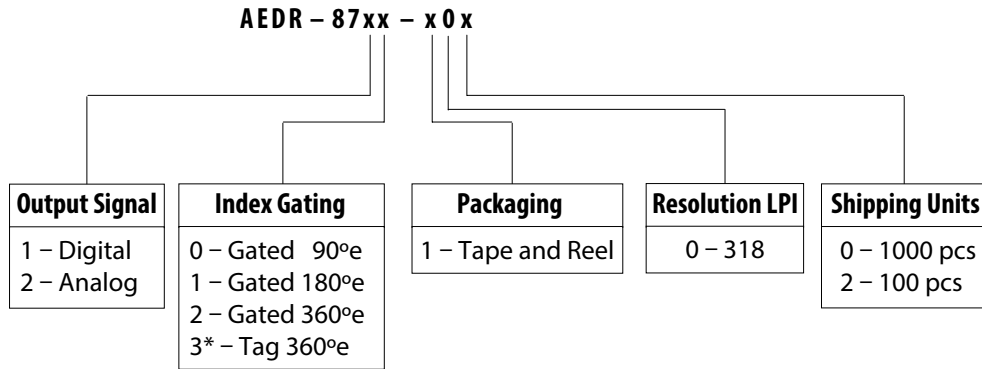

Notes:

Digital 3.3 V and 5 V operating mode

Analog: 5 V operating mode only

3* applicable only for analog output

DISCLAIMER: Avago's products and software are not specifically designed, manufactured or authorized for sale as parts, components or assemblies for the planning, construction, maintenance or direct operation of a nuclear facility or for use in medical devices or applications. Customer is solely responsible, and waives all rights to make claims against Avago or its suppliers, for all loss, damage, expense or liability in connection with such use.

For product information and a complete list of distributors, please go to our web site: www.avagotech.com

Avago, Avago Technologies, and the A logo are trademarks of Avago Technologies in the United States and other countries.

Data subject to change. Copyright © 2005-2014 Avago Technologies. All rights reserved.

AV02-4518EN - June 6, 2014

AVAGO
TECHNOLOGIES