



Chipsmall Limited consists of a professional team with an average of over 10 year of expertise in the distribution of electronic components. Based in Hongkong, we have already established firm and mutual-benefit business relationships with customers from,Europe,America and south Asia,supplying obsolete and hard-to-find components to meet their specific needs.

With the principle of “Quality Parts,Customers Priority,Honest Operation,and Considerate Service”,our business mainly focus on the distribution of electronic components. Line cards we deal with include Microchip,ALPS,ROHM,Xilinx,Pulse,ON,Everlight and Freescale. Main products comprise IC,Modules,Potentiometer,IC Socket,Relay,Connector.Our parts cover such applications as commercial,industrial, and automotives areas.

We are looking forward to setting up business relationship with you and hope to provide you with the best service and solution. Let us make a better world for our industry!



Contact us

Tel: +86-755-8981 8866 Fax: +86-755-8427 6832

Email & Skype: info@chipsmall.com Web: www.chipsmall.com

Address: A1208, Overseas Decoration Building, #122 Zhenhua RD., Futian, Shenzhen, China



AF0500 SERIES

Arc-Flash Relay

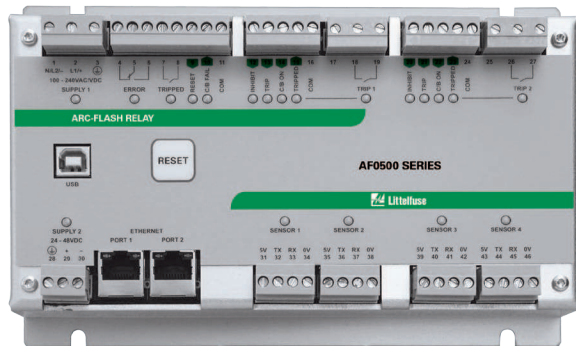

Description

The AF0500 is a microprocessor-based arc-flash relay that limits arc-fault damage by detecting the light from an arc flash and rapidly tripping the feeder breaker. The unit is well suited for switchgear, transformer and power converter applications.

Sensors, inputs, and connections are health monitored to ensure fail-safe operation. A secondary solid-state trip circuit provides a redundant trip path. A USB port is used for configuration and access to event logs.

AF0500 includes an Ethernet interface and supports Modbus[®] TCP communication. Zone tripping, upstream breaker tripping and tie breaker tripping applications can be easily configured.

A number of control inputs allows interconnection of multiple AF0500 units to form a system.

Features & Benefits

FEATURES	BENEFITS
4 arc sensor inputs	Supports both point and fiber sensors
Arc-Flash trip time <1ms	Limits arc-flash damage and risk of injury
2 IGBT high speed trip outputs	Supports applications such as upstream breaker tripping or tie breaker tripping
Universal Power Supply	100-240 Vac, 24-48 Vdc, or 110-250 Vdc supply
Fail-safe system	Continuous monitoring of optical sensors and inputs ensures protection
LED indication (on unit and each sensor)	Trip and sensor status indicated both on relay and sensors
Discrete wire networking	Multiple AF0500 units can be interconnected to form a system
USB interface	Data logging and configuration software uses a USB interface with no drivers or software installation
Data logging	On-board event recorder for system diagnostics (2048 log lines)
Ethernet interface	Modbus [®] TCP communication

Optical Sensors

The AF0500 accepts both PGA-LS10 point sensors and PGA-LS20/PGA-LS30 fiber-optical sensors. Thus any combination of fiber or point sensors is supported.

For fast fault location, front-panel and sensor LEDs indicate sensor health and which sensor detected an arc fault.

Sensor Placement

The AF0500 Arc-Flash Relay and sensors are easily installed in retrofit projects and new switchgear with little or no re-configuration. Simple applications work straight out of the box with no need of PC configuration. More complex systems with multiple power sources are configured using the relay's built-in USB interface software.

Generally, it is recommended to mount 1 or 2 sensors per cubicle to cover all horizontal and vertical bus bars, breaker compartments, drawers, and anywhere that there is a risk for an arc fault. Threading a fiber-optic sensor through the cabinets and in areas where point-sensor coverage is uncertain results in complete coverage and an added level of redundancy. Even if policy is to only work on de-energized systems, all maintenance areas should be monitored to prevent potential damage and additional cost.

Ordering Information

ORDERING NUMBER	DESCRIPTION
AF0500-00	Arc-Flash Relay
AF0500-00-CC	Arc-Flash Relay, Conformally Coated

ACCESSORIES	REQUIREMENT
PGA-LS10	Required*
PGA-LS20, PGA-LS30	Required*
PGA-1100	Optional

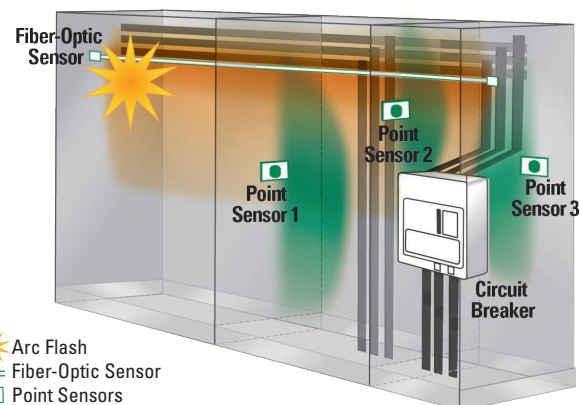

AF0500 SERIES

Applications

Zone Tripping

AF0500 can trip 2 separate zones. Sensors can be assigned to the zones individually through PC configuration.

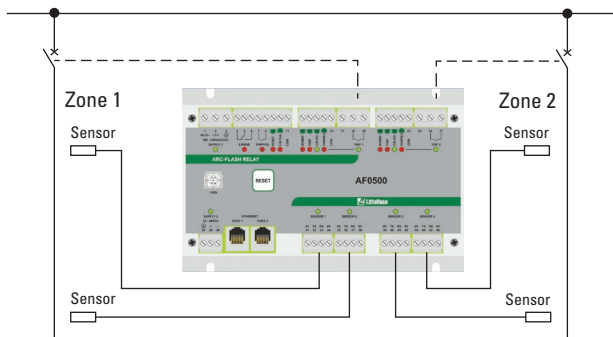

Upstream Breaker Tripping

In case of failure of the local circuit breaker to open, another trip command is sent after a short delay to an upstream breaker to clear the fault.

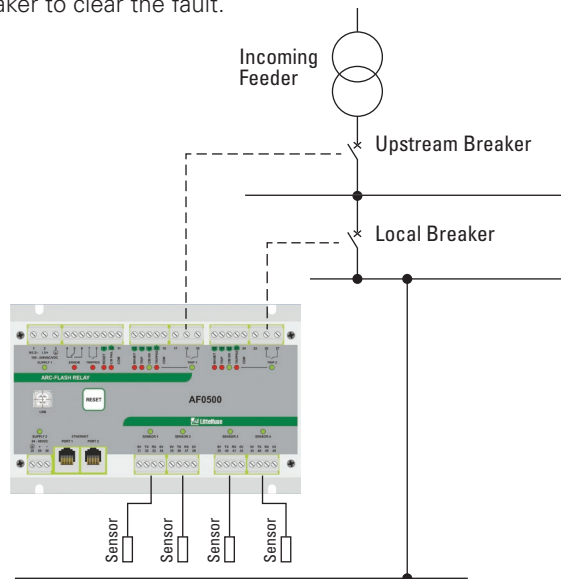

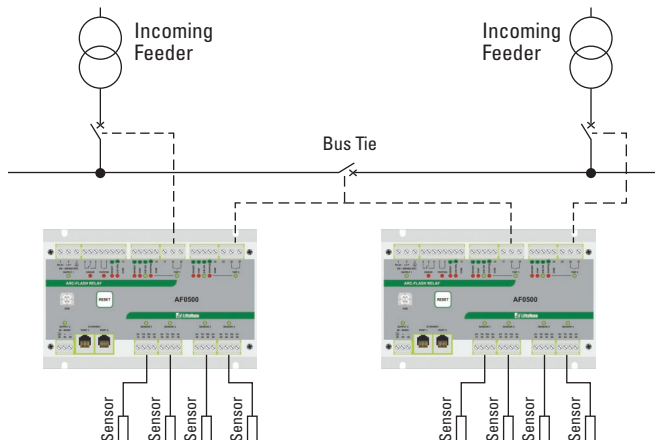

Tie Breaker Tripping

In case of an arc in one section of the switchboard, the AF0500 can trip both the incoming feeder and the tie breaker simultaneously. Thus the affected part of the switchboard is isolated from the non-affected part.



Accessories

- 
PGA-LS10 Point Sensor
 Line-of-sight light sensor detects an arc as small as 3 kA within a 2-m half-sphere. Includes Sensor health and trip indication.

- 
PGA-LS20/PGA-LS30 Fiber-Optic Sensor
 360° light sensor to run along bus bars. Sensor health and trip indication.

- 
PGA-1100 Diode Logic Unit
 This module allows multiple arc-flash relays to trip a common breaker, for example a tie-breaker.

Specifications

Power Supply	
Universal	100 to 240 Vac (+10%, -15%) 50/60 Hz, 20 VA, 110 to 250 Vdc (+10%, -20%) 8 W
Low Voltage	24 to 48 Vdc (+10%, -20%), 4 W
Sensor Inputs	4 light sensor inputs for PGA-LS10, PGA-LS20 and PGA-LS30 sensors
Trip Outputs	2 IGBT switches
UL Rating	120/240 Vac, 1800 VA, 0.75 A maximum continuous, 125/250 Vdc, 138 VA, 0.75 A maximum continuous
Supplemental Rating	
Make/Carry	30 A for 0.2s
Voltage Rating	24 to 300 Vac, 24 to 300 Vdc
Current Rating	20 A for 2 s, 10 A for 5 s

Communication	Ethernet, 2 ports with internal Ethernet switch, Modbus® TCP
Dimensions	H 130 mm (5.1"); W 200 mm (7.9"); D 54 mm (2.1")
Shipping Weight	0.9 kg (2 lb)
Operating Temp.	-40°C to +70°C (-40°F to 158°F)
Approvals	UL Listed (UL508), CE, RCM, FCC, CSA
Warranty	5 years
Mounting	Surface, DIN (with optional D0050 adapter clips)