



Chipsmall Limited consists of a professional team with an average of over 10 year of expertise in the distribution of electronic components. Based in Hongkong, we have already established firm and mutual-benefit business relationships with customers from,Europe,America and south Asia,supplying obsolete and hard-to-find components to meet their specific needs.

With the principle of “Quality Parts,Customers Priority,Honest Operation,and Considerate Service”,our business mainly focus on the distribution of electronic components. Line cards we deal with include Microchip,ALPS,ROHM,Xilinx,Pulse,ON,Everlight and Freescale. Main products comprise IC,Modules,Potentiometer,IC Socket,Relay,Connector.Our parts cover such applications as commercial,industrial, and automotives areas.

We are looking forward to setting up business relationship with you and hope to provide you with the best service and solution. Let us make a better world for our industry!



Contact us

Tel: +86-755-8981 8866 Fax: +86-755-8427 6832

Email & Skype: info@chipsmall.com Web: www.chipsmall.com

Address: A1208, Overseas Decoration Building, #122 Zhenhua RD., Futian, Shenzhen, China



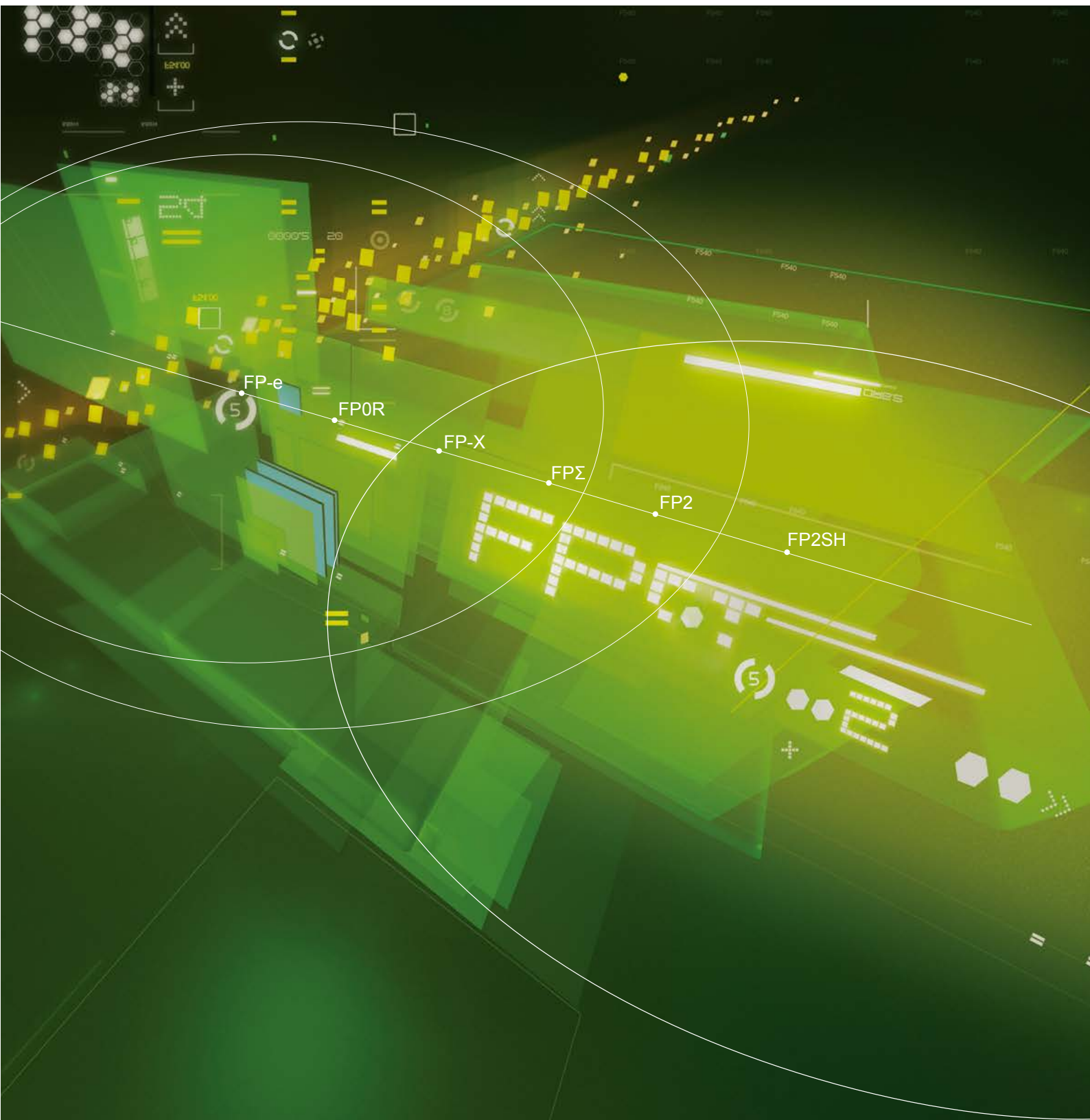

Selection of Products

Model Features		FP-e		FP0R				FPΣ			
		PLC + Display + Switch All-in-one controller with six functions		Controller superior to basic ultra-compact models Ideal for use in extremely narrow spaces				High performance ultra-compact controller Reliably supports the control of higher-speed equipment with more functions featured			
											
		*The FP-e will be discontinued at the end of September, 2019.									
CPU (control unit) type		Basic type	With thermocouple input type	C10, C14 and C16	C32	T32	F32	C24	C28	C32	
Maximum controllable I/O points		14 points	12 points	106 to 112 points	128 points	128 points	128 points	376 points	380 points	384 points	
Connectable expansion units		-		3 units				7 units (Right: 3, Left: 4)			
Program capacity		2.7 k steps		16 k steps	32 k steps			32 k steps			
Comment memory		-		Available (Built-in memory)				Available (Built-in memory)			
Operation speed (basic instructions)		0.9 μs/step (basic instructions)		0.08 μs (Up to 3 k steps), 0.58 μs (3 k and later steps)				0.32 μs/step (basic instructions)			
Data register		1,660 words		12,315 words	32,756 words			32,765 words			
Internal relay		1,008 points (63 words)		4,096 points (256 words)				4,096 points (256 words)			
Network compatibility	Ethernet	Available (with FP Web Server 2 and KS1 Signal converter)									
	FL-NET	-		-				-			
	Modbus-RTU	Available (RS485 type)		Available (RS485)				Available (RS485 communication cassette)			
	CC-Link	-		Available (Slave, CC-Link unit)				Available (Slave, CC-Link unit)			
	Computer link (MEWTOCOL)	Available (Tool port, COM port)		Available (Tool port, COM port)				Available (Tool port, communication cassette)			
	General-purpose serial (nonprocedural)	Available (COM port)		Available (COM port)				Available (Tool port, communication cassette)			
	PLC link	W	-		-				-		
		W0	-		Available (RS232C, 1-to-1) (RS485, Up to 16 units)				Available (RS485 communication cassette)		
		W2	-		-				-		
		VE	-		-				-		
	Remote I/O (MEWNET-F)	-		Available (64-point slave stations, I/O link unit)				Available (64-point slave stations, I/O link unit)			
	S-LINK	-		Available (FP0-SL1 control unit)				Available (S-LINK unit)			
S-LINK V	-		-				-				
Motor control	Built-in pulse output	2 axes/10 kHz	2 axes/5 kHz	4 axes/50 kHz (C16, C32 or T32)				2 axes/100 kHz (Transistor output type)			
	Positioning unit	-		-				2-axis/4-axis type, up to 16 axes			
	PWM output	2 points/1 kHz/1,000 resolution		4 points/4.8 kHz/1,000 resolution (C16, C32, T32 or F32)				2 points/12 kHz/1,000 resolution (Transistor output type)			
	High-speed counter	4 channels/10 kHz	4 channels/5 kHz	6 channels/50 kHz				4 channels/50 kHz			
Analog measurement	Voltage/current input	-		4 channels/unit, 8 channels/unit	2 channels input and 1 channel output/4 channels input and 2 channels output mixed unit			4 channels/unit, 8 channels/unit	2 channels input and 1 channel output/4 channels input and 2 channels output mixed unit		
	Voltage/current output	-		4 channels/unit				4 channels/unit			
	Temperature input	-	2 channels (thermocouple)	8 channels thermocouple unit				8 channels thermocouple unit			
Calendar timer (clock function)		Available (With calendar timer type)		Available (T32 only)				Available			
Others		Front panel switch input: 8 points		MiniUSB port provided				Potentiometer input: 2 points			

FP-X

High performance compact terminal block type controller
Wide selection of add-on cassettes allows space-saving use of the controller for a variety of purposes



FP2SH

Scan time: 1 ms/20 k steps
Advanced version of FP2 capable of ultra-high speed processing



C14	C30	C60	C2L	C2	C2P <small>(with IC memory card interface)</small>	C3P <small>(with IC memory card interface)</small>
328 points	352 points	382 points	2,048 points (8,192 points with the remote I/O system)			
8 units + Add-on cassettes (up to 3)			32 units (When the H type backplane is used)			
16 k steps	32 k steps		32 k steps	60 k steps		120 k steps
Available (Built-in memory)			Available (Built-in memory)			
0.32 μs/step (basic instructions)			0.03 μs/step (basic instructions)			
32,765 words			10,240 words (Exc. file register. See the end of this table.)			
4,096 points (256 words)			14,192 points			
Available (Ethernet communication cassette)			Available (ET-LAN unit)			
-			Available (VE link unit)			
Available (RS485 communication cassette)			-			
Available (Slave and FP0 CC-Link unit)			-			
Available (Tool port and communication cassette)			Available (COM port, CCU and MCU)			
Available (Tool port and communication cassette)			Available (COM port, SDU and MCU)			
-			Available (MW link unit)			
Available (RS485 communication cassette)			Available (MCU)			
-			Available (MW link unit)			
-			Available (VE link unit)			
Available (64-point slave stations and FP0 I/O link unit)			Available (Master: MW link unit) (Slave: RMS unit)			
-			Available (S-LINK unit)			
-			Available (S-LINK V unit)			
2 axes/100 kHz + 2 axes/20 kHz (Transistor output type)			-			
1 axis/100 kHz (pulse I/O add-on cassette)			RTEX, Multifunction type and Interpolation type			
4 points/12 kHz/1,000 resolution (Transistor output type)			4 points/30 kHz/100 resolution (Pulse I/O unit)			
8 channels/50 kHz			4 points/200 kHz (FP2-HSCT and FP2-PXYT)			
2 channels/cassette	2 channels input and 1 channel		8 channels (FP2-AD8VI and FP2-AD8X)			
2 channels/cassette	output mixed cassette		4 channels (FP2-DA4)			
2 channels thermocouple input and 2 channels R.T.D. input cassettes			8 channels thermocouple/R.T.D. (FP2-AD8X and FP2-RTD)			
Available (MRTC cassette)			Available (Built-in type)			
With a USB port (C30 and C60)			File register (60 k steps / 120 k steps: 32,765 words x 3 banks) (32 k steps: 32,765 words)			

Compact type PLC achieves high-speed and high-accuracy positioning.

FPΣ

The palm-size ultra-compact PLC allows for the establishment of a network servo system with up to 16 axes.

Positioning unit RTEX is compatible with Panasonic MINAS A4N/A5N "Realtime Express," enabling the construction of a high-speed, high-accuracy, wire-saving servo system. The cumbersome wiring work will be significantly reduced, contributing to the quick startup of equipment with a multi-axis control function. (A5N is supported from Ver. 1.30.)

*Mixed use of MINAS A4N and A5N is not possible.

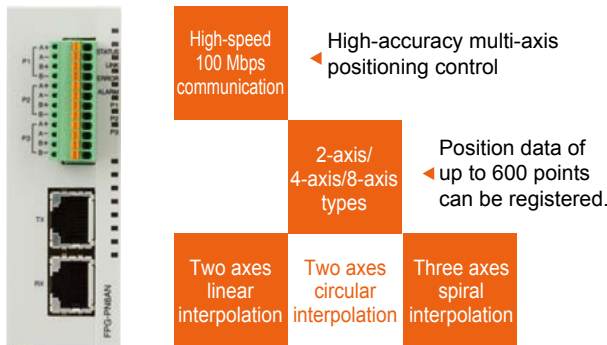

- Compatible with commercially-available LAN cables, significantly reducing wiring costs
- Equipped with a manual pulser input, allowing for fine teaching

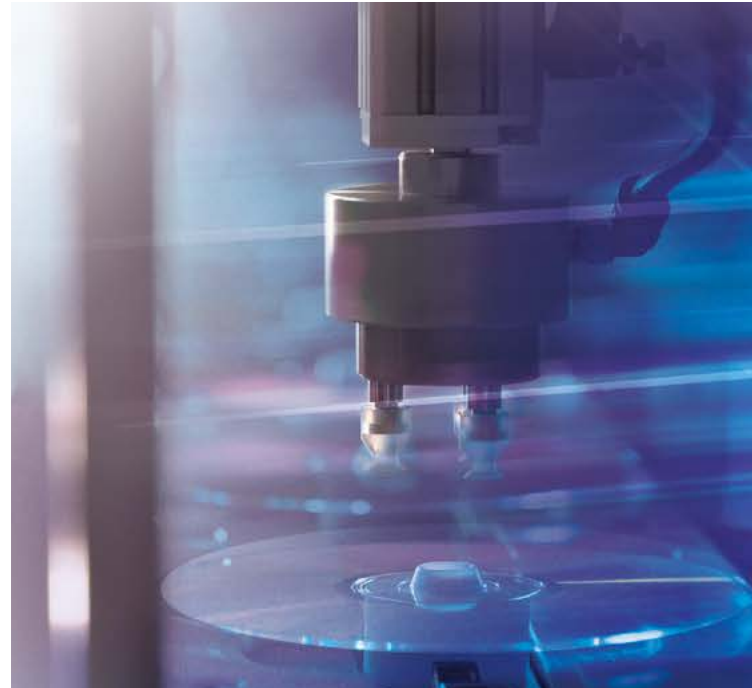

Configurator
PM

Dedicated tool software

Configurator PM

Reliable and user-friendly software tool for the process from setting through startup and operation monitoring for the functions, including specification of axes to be used, parameter setting, data table creation, JOG operation, home return, and data monitoring.



MINAS

AC servomotors in the best match to FPΣ

MINAS A5 Series

Panasonic Corporation, Motor business unit

- Features an upgraded real-time auto tuning function
- The improved vibration damping property made the motor usable in a wide variety of mechanisms. The operability for both low and high rigidity mechanisms has been improved.
- Usable for a wide range from position to speed and torque instructions



Controls up to 256 axes, adequately supporting large-scale equipment control

FP2SH

- Up to 8-axis type RTEX 32 units can be connected, and up to 256 axes can be controlled. (when using H type backplane).
- Use in combination with the ultra-high speed and large capacity CPU unit [20 k step/1 ms (measured by our company), program capacity of 120 k steps] adequately supports the control of large-scale equipment.

Positioning control available with the more compact body with built-in 4-axis pulse outputs

FP0R

The four built-in channels of a maximum of 50 kHz pulse output allow for simultaneous 2-axis linear interpolation of two sets.

No complicated speed calculation or programming is required. 2-axis linear interpolation is available by using the F175 dedicated instruction. Two sets such as two X-Y tables, for example, can be simultaneously controlled.

FP0R



Two-axis X-Y table x 2

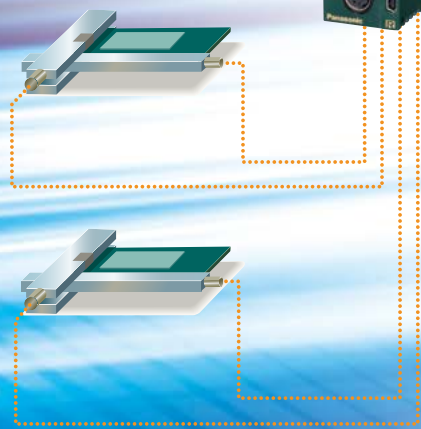

Variety of positioning instructions available

■ Jog positioning control (F171 instruction)

The motion can be started without a preset target value. When a stop signal is input, the target value is set, and the motion is slowed to a stop.

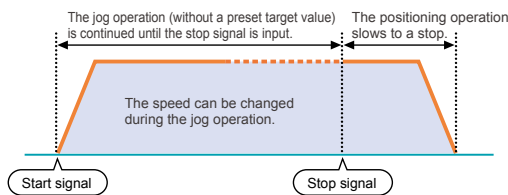

■ Measuring the pulse frequency (F178 instruction)

Pulses input in a specified period by a single instruction are counted, and the frequency is calculated.

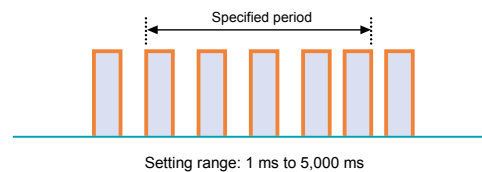

Built-in 100 kHz pulse outputs for two axes and 20 kHz for two axes

FP-X

For relay output type even 2-axis linear interpolation

With two add-on pulse I/O cassettes (AFPX-PLS), linear interpolation can be performed at a maximum of 80 kHz synthetic speed by using F175 (SPSH) instruction, which is the same instruction for the transistor output type.



100 kHz × 2 axes

20 kHz × 2 axes

Smallest class compact PLC analog unit

FP-X

Ultra-compact add-on cassettes for analog control

"Require slightly more functions", "Want to add functions to the existing equipment"
The rich variety of add-on cassettes helps solve these requirements. The Add-on cassette easily adds small quantities of functions and I/O points

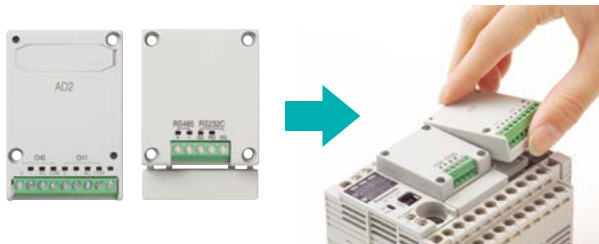

Easily removable
(Two screws to secure the unit)

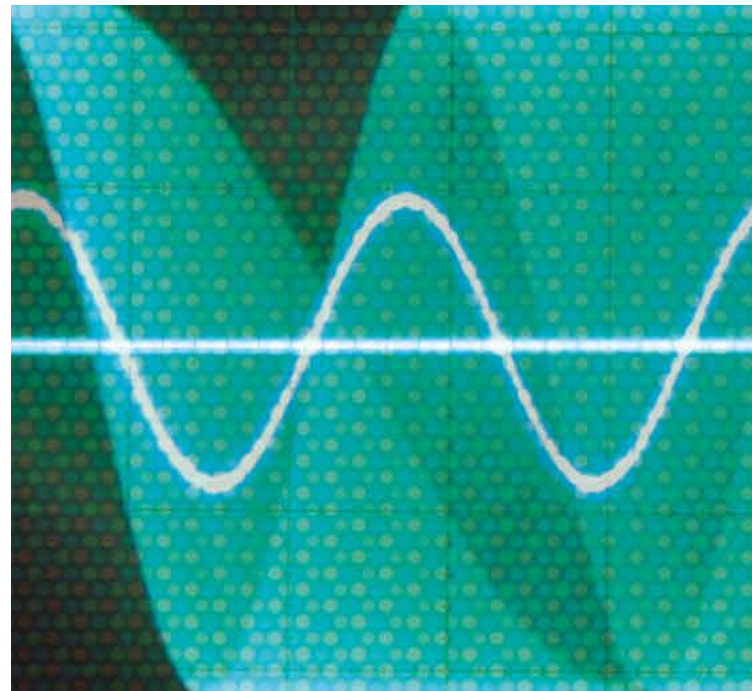

AFPX-AD2	Analog input cassette (0 to 10 V/0 to 20 mA, 12-bit, non-insulated two points)
AFPX-A21	Analog I/O cassette Input: 2 channels (0 to 5 V/0 to 10 V or 0 to 20 mA, 12-bit, insulated) Output: 1 channel (0 to 10 V or 0 to 20 mA, 12-bit, insulated)
AFPX-DA2	Analog output cassette 2 channels (0 to 10 V or 0 to 20 mA, 12-bit, insulated 2 channels)
AFPX-TC2	Thermocouple input cassette (K/J type, Resolution: 0.2 °C 32.36 °F, insulated 2 channels)
AFPX-RTD2	R.T.D. input (insulated) 2 channels (Channels insulated)

FP2SH

Multi-range control of a variety of equipment is possible. The unit can be directly connected with thermocouples and resistance temperature detectors.

Achieved by a variety of units, including three “analog input type” units and multiple channel “analog output type” units (four channels per unit)

■ Analog input types

High-speed, high-accuracy, multiple-input unit with isolated channels



- High speed** Highly reliable isolation among channels
Temperature conversion: 20 ms/ch
Voltage conversion: 5 ms/ch
(Without insulation setting: 500 µs/ch)
- High accuracy** High accuracy conversion
Voltage: ±0.1 % (25 °C 77 °F)
Temperature: ±0.3 % (0 to 55 °C 32 to 131 °F)
- Multiple inputs** A single unit supports inputs of thermocouple, R.T.D., and voltage *1

AFP2401

Input unit solely for R.T.D. (Pt100/Pt1000)



- High speed and high accuracy**
- Conversion speed: 20 ms/ch
Conversion accuracy: ±0.3 %
(0 to 55 °C 32 to 131 °F)

AFP2402

Low cost input solely for voltage/current data



- Low cost**

AFP2400L

■ Analog output type

Supports multiple channels. (Four channels per unit)



- High speed and high accuracy**
- Conversion speed: 500 µs/ch
Over accuracy: ±1.0 %F.S. or less
(0 to 55 °C 32 to 131 °F)

AFP2410

*1 Current inputs can be converted into voltage inputs by attaching the supplied external resistor to the input terminal section.

Simple temperature control

FP-X

The advanced PID control facilitates high-speed, high-accuracy multi-point temperature control.

Multi-point PID control

High-accuracy PID control

By adopting a sophisticated algorithm and floating-point operations

Two modes selectable

High-speed control PI-D*1 mode and
Overshoot suppression I-PD*2 mode
*1 (Derivative type) *2 (Proportional-derivative type)

Ultra high-speed computations in a 32 μs/loop

Simple parameter setting

By adopting simultaneous multi-point auto-tuning

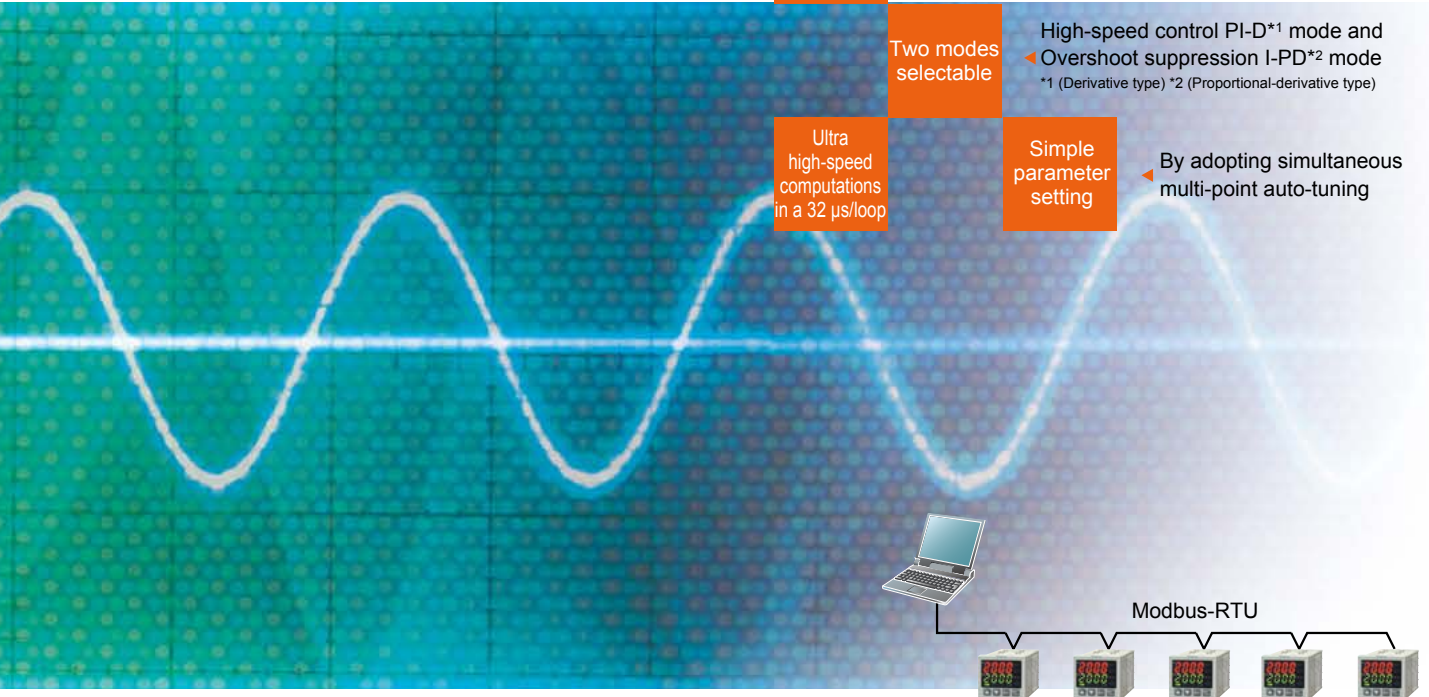

Multiple temperature controllers

Easy unification of data management

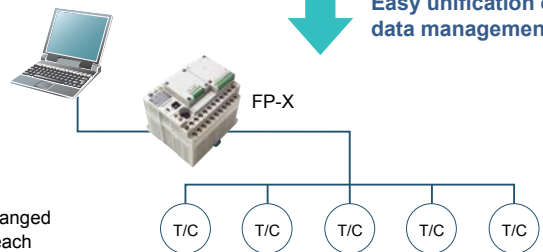

The number can even be increased up to 28 channels by using the thermocouple input cassette and FP0 thermocouple unit.

- By combining with a sequence control, the parameters (Kp, Ti, Td, etc.) can be changed during a PID control execution, thereby enabling optimum temperature control in each stage including start up, midrange, and convergence. The ability to change the target value easily enables multi-step temperature control, which was difficult only with temperature controllers. In addition, the multi-point temperature control enables the centralized control of multiple temperature controllers with a single FP-X for unified data management.

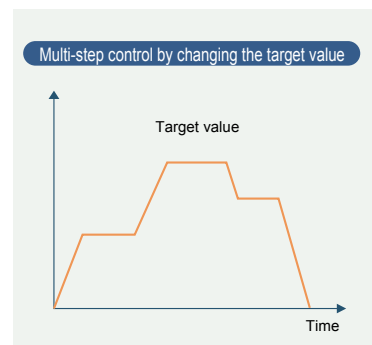
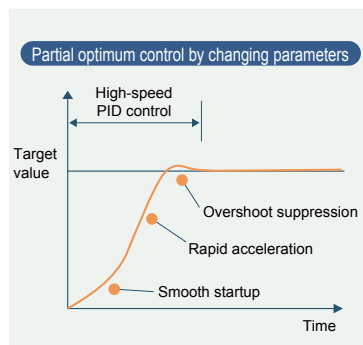
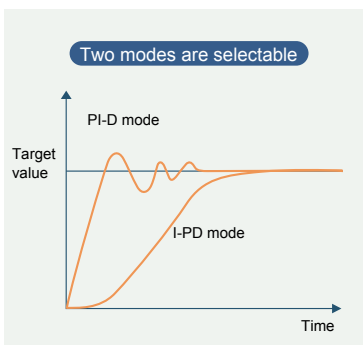

Operation speed:
900 ns

Maximum I/O points:
14 points / 12 points +
Thermocouple input

With
display

Panel
mounted
type

Panel-mount type all-in-one controller - Combination PLC and display



Features

- 3-color, 5-character and 2-line Display
- Front operation switch
- Equivalent to FP0-C14 intelligence of small PLCs
- Easy programming using Wizard
- Smooth debug with R and I modes
- Panel mounted type (IP66)

*The FP-e will be discontinued at the end of September, 2019.

DISPLAY MODES AND FUNCTIONS

1 N mode
(Normal mode)

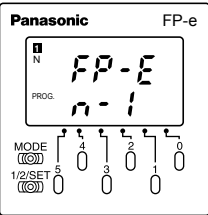

Displays any characters and numerical values, and numerical data can be changed.

2 S mode
(Switch mode)

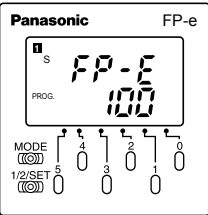

Can also display characters and numerical values. Operation switches can be used for external input.

3 R mode
(Register mode)

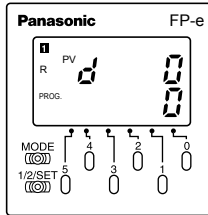

Operation memory in the controller can be monitored and its data can be changed.

4 I mode
(I/O monitor mode)

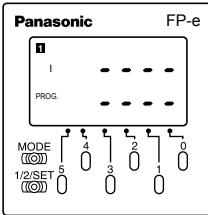

I/O status (X and Y) in the controller can be monitored.

SPECIFICATIONS

Performance specifications

Item		Model		AFPE224300		AFPE224302		AFPE224305		AFPE214325		AFPE214322	
				Basic type (RS232C)		Basic type (RS485)		Calendar timer type (RS232C)		Thermocouple input type (RS232C)		Thermocouple input type (RS485)	
Number of controllable I/O points	Control unit	14 points [Input: 8, Output: 6 (Transistor NPN: 5 / Relay: 1)]										12 points [Input: 6, Output: 6 (Transistor NPN: 5 / Relay: 1)]	
	Front switch input	8 points											
Program memory	Built-in memory	Built-in EEPROM											
Program capacity		2,720 steps											
Operation speed		0.9 μs/step (for basic instruction)											
Clock / calendar function		Not available				Year, month, day, hour, minute, second and day of week (However, this can only be used when a battery has been installed.)				Not available			
Battery life		Not available				220 days or more (actual usage value: 870 days approx. (25 °C 77 °F). Periodic replacement interval: 1 year (Value applies when no power is supplied at all.))				Not available			
Pulse catch input		6 points in total											
Interrupt input		(X0 and X1: 50 μs, X2 to X5: 100 μs)											
COM. port		RS232C		RS485		RS232C		RS232C		RS232C		RS485	
Periodical interrupt		0.5 ms to 30 sec.											
Constant scan		Available											
Password		Available											
Special functions	High-speed counter function	Counter mode: Addition / subtraction (1-phase) Input points: 4 channels max.											
		Maximum counting speed: 10 kHz (total of 4 channels)					Maximum counting speed: 5 kHz						
		Counter mode: 2-phase / individual / direction decision (2-phase) Input points: 2 channels max.											
		Maximum counting speed: 2 kHz (total of 2 channels)					Maximum counting speed: 1 kHz						
Pulse output function	Output points	2 independent points (Y0 and Y1) (No interpolation function)											
	Output frequency	40 Hz to 10 kHz (Y0 or Y1: 1 point)				40 Hz to 5 kHz (Y0 and Y1: 2 points)				40 Hz to 5 kHz (1 point), 40 Hz to 2.5 kHz (2 points)			
PWM output function	Output points	2 points (Y0 and Y1)											
	Output frequency	Frequency: 0.15 Hz to 1 kHz, Duty: 0.1 % to 99.9 %											

Operation speed:
80 ns (up to 3 k steps)
580 ns (3 k and later steps)

Maximum I/O points:
128 points

Program capacity:
32 k steps

Tool port:
miniUSB

Battery-less:
F type

Pocket-size ultra-compact controller for use in extremely narrow spaces



Features

- **Large capacity program/data memory**
Program capacity: 32 k steps max.
Data register: 32 k words max.
- **Ultra-high speed processing**
80 ns / step (ST instruction)
* Within a range of 0 to 3,000 program steps
- **USB tool port provided as standard equipment**
Capable of high-speed program transfer with USB 2.0
- **Multi-axis control available without expansion units**
Built-in pulse outputs for four axes (50 kHz max. each)
- **Battery-less automatic backup of all data**
The F type has a built-in FeRAM, industry's first, that allows the automatic saving of all data without a backup battery.

SPECIFICATIONS

Performance specifications

Item		C10 (Relay output type only)	C14 (Relay output type only)	C16 (Transistor output type only)	C32 (Transistor output type only)	T32 (Transistor output type only)	F32 (Transistor output type only)
Programming method / Control method		Relay symbol / Cyclic operation					
Number of controllable I/O points	Control unit only (No expansion)	10 points (Input: 6, Output: 4)	14 points (Input: 8, Output: 6)	16 point (Input: 8, Output: 8)	32 points (Input: 16, Output: 16)	32 points (Input: 16, Output: 16)	
	W/expansion 1 * Same type of control and expansion units	Max. 58 points	Max. 62 points	Max. 112 points	Max. 128 points	Max. 128 points	
	W/expansion 2 * Mix type of relay and transistor units	Max. 106 points	Max. 110 points	Max. 112 points	Max. 128 points	Max. 128 points	
Program memory		Built-in flash EEPROM (no backup battery required)					
Program capacity		16,000 steps			32,000 steps		
Number of instructions	Basic instructions	110 types approx.					
	High-level instructions	210 types approx.					
Operation speed	Up to 3,000 steps	Basic instructions: 0.08 μs min., Timer instructions: 2.2 μs min., High-level instructions: 0.32 μs min. (MV instruction)					
	3,001st and later steps	Basic instructions: 0.58 μs min., Timer instructions: 3.66 μs min., High-level instructions: 1.62 μs min. (MV instruction)					
Operation memory	Relay	Internal relay (R)					
		Timer / Counter (T / C)					
	Memory area	Data register (DT)			32,765 words		
		Index register (IX, IY)			14 words (I0 to ID)		
Master control relay (MCR)		256 points					
Number of labels (JMP and LOOP)		256 points					
Differential points		Equivalent to the program capacity					
Number of step ladder		1,000 stages					
Number of subroutines		500 subroutines					
Special functions	High speed counter	Single-phase 6 channels (Max. 50 kHz each) or 2-phase 3 channels (Max. 15 kHz each) (Note)					
	Pulse output	Not available			4 channels (Max. 50 kHz each) Two channels can be controlled individually. (Note)		
	PWM output	Not available			4 channels (6 Hz to 4.8 kHz)		
	Pulse catch input / interrupt input	Total 8 channels (with high speed counter)					
	Interrupt program	Input: 8 programs (6 programs for C10 only) / Periodic: 1 program / Pulse match: 4 programs					
	Periodical interrupt	In units of 0.5 ms: 0.5 ms to 1.5 sec. / In units of 10 ms: 10 ms to 30 sec					
	Constant scan	In units of 0.5 ms: 0.5 ms to 600 ms					
	RS232C port	One RS232C port is mounted on each of C10CRS, C10CRM, C14CRS, C14CRM, C16CT, C16CP, C32CT, C32CP, T32CT, T32CP, F32CT and F32CP type (3P terminal block) Transmission speed (Baud rate): 2,400 to 115,200 bps, Transmission distance: 15 m 49.2 ft , Communication method: half duplex					
RS485 port	One RS485 port is mounted on each of C10MRS, C14MRS, C16MT, C16MP, C32MT, C32MP, T32MT, T32MP, F32MT and F32MP type (3P terminal block) Transmission speed (Baud rate): 115.2 kbps (It is possible to change to 19.2 kbps by the setting.), Transmission distance: 1,200 m 3937.0 ft , Communication method: half duplex						
Maintenance	Memory backup	Program and system register				Stored program and system register in flash EEPROM	
		Operation memory				Backup of the entire area by a built-in secondary battery	
	Self-diagnostic function				Watchdog timer (690 ms approx.), program syntax check		
	Real-time clock function				Not available		
	Other functions				Available		
		Program edition during RUN, download in RUN mode (incl. comments), 8-character password setting and program upload protection				Not available	

Note: For the limitations while operating units, see the manual.

Operation speed:
320 ns

Maximum I/O points:
384 points

Program capacity:
32 k steps

Positioning:
network servo,
Max. 16 axes

Positioning:
pulse output 4 Mpps,
start up: 0.005 ms

High-performance ultra-compact PLC



Features

- Abundant program capacity: 32 k steps**
 The 32 k steps program capacity can accommodate an increase in the number of programs accompanying functionality enhancements, expansions, or changes of equipment.
- Equipped with an independent comment memory**
 All of 100,000 comments, 5,000 lines of block comments, and 5,000 lines of remark comments are saved in FPΣ together with programs.
- Equipped with a high-speed RISC processor**
 Equipped with a RISC processor, achieving high-speed processing with a scan time of less than 2 ms approx. for 5,000 steps
- High-speed positioning unit**
 The 4 Mpps maximum frequency and start up speed of 0.005 ms allow use for linear servo control.
- Simple temperature control**
 A temperature control program can be written in only one line by using the PID instruction F356 (EZPID), facilitating temperature control by a PLC, which had previously been considered difficult.

SPECIFICATIONS

Performance specifications

Item		Specifications			
		AFPG2543H / AFPG2543HTM	AFPG2643H / AFPG2643HTM	AFPG2423H / AFPG2423HTM	AFPG2653H / AFPG2653HTM
Number of controllable I/O points	Control unit	32 points (DC input: 16, NPN output: 16)	32 points (DC input: 16, NPN output: 16)	24 points (DC input: 16, relay output: 8)	28 points (DC input: 16, PNP output: 12)
	With FP0R expansion units	Max. 128 points (up to 3 units) * When using transistor output type expansion units	Max. 128 points (up to 3 units) * When using transistor output type expansion units	Max. 120 points (up to 3 units) * When using transistor output type expansion units	Max. 124 points (up to 3 units) * When using transistor output type expansion units
	With FPΣ expansion units	Not possible	Max. 288 points (up to 4 units) * When using transistor output type expansion units	Max. 280 points (up to 4 units) * When using transistor output type expansion units	Max. 284 points (up to 4 units) * When using NPN output type expansion units
	With FP0R and FPΣ expansion units	Max. 128 points * When using transistor output type expansion units	Max. 384 points * When using transistor output type expansion units	Max. 376 points * When using transistor output type expansion units	Max. 380 points * When using NPN output type expansion units
Programming method / Control method		Relay symbol / Cyclic operation			
Program memory		Built-in flash ROM (no backup battery required)			
Program capacity		32 k steps			
Number of instructions	Basic instructions	93 types			
	High-level instructions	216 types	218 types	216 types	218 types
Operation speed		Basic instruction: 0.32 μs min. / step			
Operation memory	Relay	Internal relay (R)	4,096 points: R0 to R255F (Note 1)		
		Timer / Counter (T / C)	1,024 points (Note 1, 2) [for initial setting, timer: 1,008 points (T0 to T1007), Counter: 16 points (C1008 to C1023)] Timer: Counts each unit up to 32,767 times (units: 1 ms, 10 ms, 100 ms, or 1 sec.). Counter: Counts 1 to 32,767		
	Memory area	Link relay (L)	2,048 points (Note 1)		
		Data register (DT)	32,765 words (DT0 to DT32764) (Note 1)		
	Link data register (LD)	256 words (Note 1)			
	Index register (I)	14 words (I0 to ID)			
Differential points		Unlimited			
Master control relay points (MCR)		256 points			
Number of labels (JP and LOOP)		256 points			
Number of step ladders		1,000 stages			
Number of subroutines		100 subroutines			
Pulse catch input		8 points (X0 to X7)			
Number of interrupt program		9 programs [8 external input points (X0 to X7), 1 periodical interrupt point (0.5 ms to 30 sec.)]			
Self-diagnosis function		E. g. watchdog timer, program syntax check			
Clock / calendar function		Year (last two digits), month, day, hour (24-hour display), minute, second and day of week (However, this function can only be used when a battery has been installed.) (Note 3)			
Potentiometer (volume) input		2 points, resolution: 10 bits (K0 to K1000)			
Battery life		220 days or more [actual usage value: 840 days approx. (25 °C 77 °F)]. Suggested replacement interval: 1 year. (Value applies when no power is supplied at all.)			
Comment storage		All kinds of comments, including I/O comments, remarks, and block comments, can be stored (no backup battery required).			
Link function		Computer link (1:1, 1:N) (Note 4), General-purpose communication (1:1, 1:N) (Note 4, 5), PLC link (Note 6)			
Other functions		Program edition during RUN, constant scan, forced on / off, password, floating-point operation, and PID			
Linear / Circular interpolation for positioning		Not available	Available	Not available	Available

Notes: 1) If no battery is used, only the fixed area is backed up (Counters 16 points: C1008 to C1023, Internal relays 128 points: R2480 to R255F, data registers 55 words: DT32710 to DT32764). When the optional battery is used, data can be backed up. Areas to be held and not held can be specified using the system registers. (Exclusive instructions allow writing and reading data in flash ROM.)

2) The number of points can be increased by using an auxiliary timer.

3) Precision of calendar timer: At 0 °C 32 °F, less than 119 seconds error per month, At 25 °C 77 °F, less than 51 seconds error per month, At 55 °C 133 °F, less than 148 seconds error per month

4) An optional communication cassette (RS232C type) is required in order to use 1 : 1 communication.

5) An optional communication cassette (RS485 type) is required in order to use 1 : N communication.

6) An optional communication cassette (RS485 type) is required.

•When the communication cassette is attached and it communicates, re-send processing is recommended.

Operation speed:
320 ns

Maximum I/O points:
382 points

Program capacity:
32 k steps

Tool port:
USB

Ethernet

Add-on cassette x 3

Transistor output:
0.5 A

**Equipped with a USB port for easy connection to a PC.
Also compatible with Ethernet.**



- Features**
- Abundant program capacity: 32 k steps**
 The 32 k steps program capacity can accommodate an increase in the number of programs accompanying functionality enhancements, expansions, or changes of equipment.
 - Equipped with an independent comment memory**
 All of 100,000 I/O comments, 5,000 lines of block comments, and 5,000 lines of remark comments are saved in FP-X together with programs.
 - Equipped with a high-speed RISC processor**
 Equipped with a RISC processor, achieving high-speed processing with a scan time of less than 2 ms approx. for 5,000 steps
 - Add-on cassettes can expand the functionality, maintaining the space-saving size.**
 Up to three add-on cassettes can be attached to the control unit. Functionality can be enhanced without increasing the required footprint. The 17 types of add-on cassettes, including the communication and analog types, cover a wide variety of applications.
 - Multi-axis control by the built-in pulse output**
 The transistor output type controller has a built-in pulse output that allows multi-axis control of the servo and stepping motors. C14: 3 axes, C30/C60: 4 axes

SPECIFICATIONS

Performance specifications

Item			Specifications		
			C14	C30	C60
Number of controllable I/O points	Control unit	Relay output type	DC input: 8 points, relay output: 6 points	DC input: 16 points, relay output: 14 points	DC input: 32 points, relay output: 28 points
		Transistor output type	DC input: 8 points, transistor output : 6 points	DC input: 16 points, transistor output : 14 points	DC input: 32 points, transistor output : 28 points
	Maximum I/O points when expanded		254 points (Max. 366 points when using add-on cassettes and FP0R expansion units)	270 points (Max. 352 points when using add-on cassettes and FP0R expansion units)	300 points (Max. 382 points when using add-on cassettes and FP0R expansion units)
Programming method / Control method			Relay symbol / Cyclic operation		
Program memory			Built-in flash ROM (no backup battery required)		
Program capacity			16 k steps	32 k steps	32 k steps
Number of instructions	Basic instructions		89 types		
	High-level instructions		226 types		
Operation speed			Basic instruction: 0.32 μs min. / step		
I/O refresh + base time			0.2 ms [When using FP0R expansion units: 1 ms + (1.5 × Number of expansion units) ms]		
Operation memory	Relay	External inputs (X)	1,760 points (The actual usable number of points is restricted by the hardware.)		
		External outputs (Y)	1,760 points (The actual usable number of points is restricted by the hardware.)		
		Internal relay (R)	4,096 points (R0 to R255F)		
		Special internal relay (R)	192 points		
		Timer / Counter (T / C)	1,024 points: timer capable of counting (units: 1 ms, 10 ms, 100 ms or 1 sec) × 32,767, Counter capable of counting 1 to 32,767		
		Link relay (L)	2048 points		
	Memory area	Data register (DT)	12,285 words (DT0 to DT12284)	32,765 words (DT0 to DT32764)	
		Special data register (DT)	374 words		
		Link data register (LD)	256 words		
		Index register (I)	14 words		
High-speed counter (Note 1)			Built-in (transistor output): Single-phase 8 channels (50 kHz × 4 channels + 10 kHz × 4 channels) Built-in (relay output): Single-phase 8 channels (10 kHz × 8 channels) Pulse I/O cassette: Single-phase 2 channels (80 kHz × 2 channels)		
Pulse output (Note 2) / PWM output			Built-in (transistor output): 100 kHz × 2 channels + 20 kHz × 2 channels Pulse I/O cassette: One unit (one axis) 100 kHz, or two units (two axes) 80 kHz		
Time measurement			10 μs, ring counter		
Potentiometer (volume) input			2 points (K0 to K1000)	2 points (K0 to K1000)	4 points (K0 to K1000)
Constant scan			Possible		
Real-time clock			When AFPX-MRTC is attached: Year (last two digits), month, day, hours (24-hour display), minutes, seconds, day of week (However, operates only when a battery is installed.)		
Flash ROM backup	Backup by instruction P13		Data register (32,765 words)		
	Auto-backup at power failure		Counter 16 points (1,008 to 1,023), Internal relay 128 points (R2480 to R255F), Data register 55 words (C30/C60: 32,710 to 32,764, C14: 12,230 to 12,284)		
Battery backup			The memory allocated in the storage area by the system register (However, only when a battery is installed)		

Notes: 1) Specification at the rated input voltage of 24 V DC, 25 °C 77 °F. Frequency may be lower due to the voltage and temperature.
2) Maximum frequency may vary by the method of operation. Please refer to the manual for details.

Operation speed: 30 ns	Maximum I/O points: 2,048 points	Program capacity: Max. 120 k steps	Positioning: network servo, Max. 256 axes	Positioning: pulse output 4 Mpps, start up: 0.005 ms
---------------------------	-------------------------------------	---------------------------------------	---	--

Scanning time of 1 ms for 20 k steps. A high-performance model for high-speed operation.



Features

- Scanning time of 1 ms for 20 k steps**
The program of 20 k steps can be executed in 1 ms. The result is a dramatically decreased tact time and high-speed device.
- Large programming capacity of up to 120 k steps.**
Both the large programming capacities of 32 k, 60 k and 120 k are available depending on the model.
- Optional small PC card is also available.**
The small PC card is available for programming backup or data memory expansion. This allows data processing of great amounts of data.
- Built-in comment and calendar timer functions.**
These functions, options with the FP2, are built right into the FP2SH.
* The I/O units and intelligent units are the same for the FP2 series.

SPECIFICATIONS

■ Power supply and I/O specifications

Item	Specifications
Power supply	100 to 120 V AC, 200 to 240 V AC, 100 to 240 V AC, 24 V DC (varies with different units)
Input	12 to 24 V DC, 24 V DC ± common
Output	Relay output: 2 to 5 A, Transistor output: 0.1 to 0.5 A (varies with different units)

■ Performance specifications

Item	Specifications	
Number of controllable I/O points	Up to 768 points	
Expansion	Standard Up to one backplane, Max. 25 units I/O points: Max. 1,600 points Remote I/O points: Max. 8,192 points	
	H type Up to three backplanes, Max. 32 units I/O points: Max. 2,048 points Remote I/O points: Max. 8,192 points	
Operation speed	0.03 μs / step (for basic instruction)	
Built-in memory	RAM (ROM / small PC card is optional)	
Memory capacity	32 k steps approx. / 60 k steps approx. / 120 k steps approx. (varies with different units)	
Operation memory	Internal relay	14,192 points
	Timer / Counter	3,072 points in total
	Data register	10,240 words
	File register	32,765 words (32 k steps) 32,765 words × 3 (60 k / 120 k steps)

■ Supported functions

Item	Specifications
Analog I/O	Available by adding analog input and analog output units.
High-speed counter	Available by adding high-speed counter unit. (Max. 200 kHz)
Positioning	Available by adding positioning unit. (Max. 4 Mpps) * The RTEX-compatible positioning unit is also available.
Serial communication	RS232C port Standard equipped with CPU unit. Expandable by adding C.C.U., serial data unit and M.C.U.
	RS422 or RS485 Expandable by adding M.C.U.
Interrupt input	Available by adding high-speed counter unit or pulse I/O unit.

■ Supported networks

Item	Specifications
Remote I/O	S-LINK, S-LINK V or MEWNET-F
PLC link	MEWNET-W2 (Wire), MEWNET-WO, MEWNET-VE or FL-NET
Computer link	Linkable by using tool port or COM. port on CPU unit. Also available by adding M.C.U. and C.C.U.
Modem connection	Available

■ Other built-in functions

Item	Specifications
Program edition during RUN	Available
Constant scan	Available
Clock / Calendar	Built-in type

Programming Software

Control FPWIN Pro7 (IEC61131-3 compliant Windows version software)



Compliant with international standard IEC61131-3
Programming software approved by PLC Open

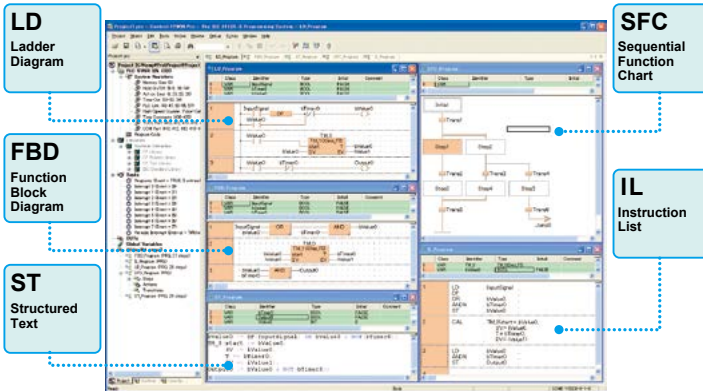

Features

- Five programming languages can be used.**
Programming can be done using the language most familiar to the developer or using the language most suited to the process to be performed. High-level (structured text) languages that allow structuring, such as C, are supported.
- Easy to reuse well-proven programs**
Efficiency when writing programs has been greatly increased by being able to split programming up for each function and process using structured programming.
- Keep know-how from getting out**
By "black boxing" a part of a program, you can prevent know-how from leaking out and improve the program's maintainability.
- Uploading of source programs from PLC possible.**
Maintainability increased by being able to load programs and comments from the PLC.
- Programming for all models in the FP series possible.**

- Programming in the language most suited to the process**

Easy-to-understand, efficient programs can be created, for example, by using a ladder program for machine control or ST for communications control.

- Programming in the language you are good at**

Programming time can be greatly reduced by the easy ability to split and then integrate programming for each function and process.

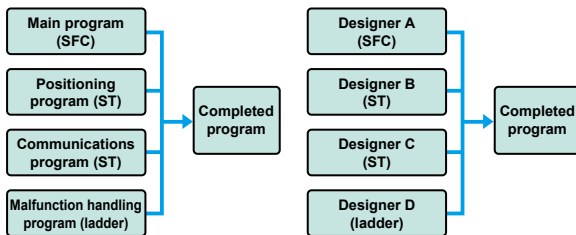

Operational Environment

OS	Windows® XP SP3 / Vista SP2 / 7 SP1 or later *1 / 8 *1 / 8.1 *1
Hard disk capacity	At least 200 MB
CPU	Pentium III processor 700 MHz or higher
Onboard memory	At least 256 MB (depends on OS)
Screen resolution	At least 1,024 × 768
Display colors	High Color (16-bit) or higher
Applicable PLC	All FP series

*1: 32 bit edition / 64 bit edition

*2: Windows, Windows XP, Vista, 7 and 8 are trademarks or registered trademarks of Microsoft Corporation in the United States and other countries.

Control FPWIN GR (Windows version software)

The ladder programming software for FP series -- highly operational software tool for maximizing convenience in the field

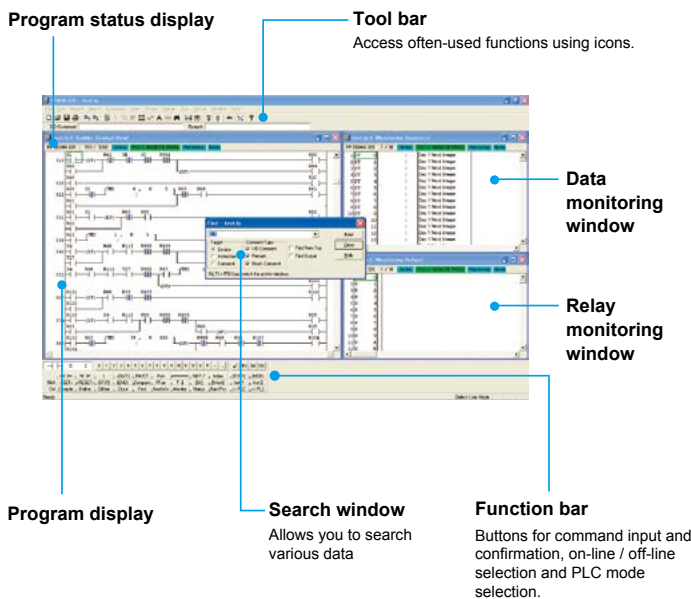

Features

- Easy field operations not requiring the use of a mouse for data entry, search, writing, monitoring and timer changes, all carried out only from the keyboard.**
- Easy programming with wizard functions.**
- Communication with GTWIN, PCWAY simultaneously through the same port.**

Operational environment

OS	Windows® XP / Vista / 7 *1 / 8 *2 / 8.1 *2
Hard disk capacity	At least 40 MB
CPU	Pentium 100 MHz or higher
Onboard memory	At least 64 MB (depends on OS)
Screen resolution	At least 1,024 × 768
Display colors	High Color (16-bit) or higher
Applicable PLC	FP0R / FP5 / FP-X / FP-e / FP2SH

*1: Windows® 7 is supported from Ver. 2.90.

*2: Windows® 8 and 8.1 is supported from Ver. 2.92.

*3: Windows, Windows XP, Vista, 7 and 8 are trademarks or registered trademarks of Microsoft Corporation in the United States and other countries.

Upload / download programs of the FP series PLC without using a PC



Data clear type
Part No.: AFP8670

Data hold type
Part No.: AFP8671

Features

- Program upload / download is possible by simple button operation.
- Ideal for program maintenance at end users' sites.

■ **Compatible PLC types:**
FP-e, FP0, FP0R, FPΣ, FP-X, FP2 and FP2SH

*FP memory loader will be discontinued at the end of September, 2019.

Data monitor software

PCWAY (Operation Data Managing Software)

Add-in software for acquiring PLC data and combining it with Microsoft Excel, spreadsheet software.

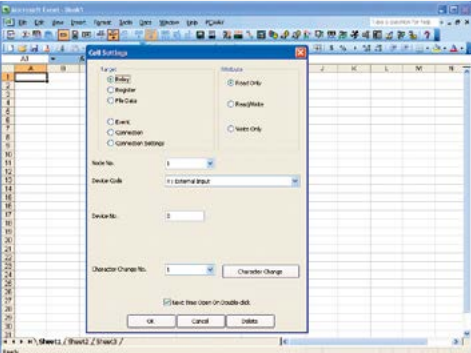

● "Cell settings" window

Features

- **Effective link between a cell of Excel and PLC relay / register**
- Notification with an alarm and inquiry on operation status can be conducted using e-mail.
- Up to 254 PLC units can be connected.
- Display change in accordance with the values of the relay and register without using the macro program
- **Automatic data storage in a text format**
Data acquisition timing can be set flexibly. (Examples: when an event and relay turn to ON, and when periodical processing is performed using a weekly timer)
- **Audio warning is available in the event of an error.**
- With the user-registered macro program started automatically, a report can also be printed out automatically.
- PLC data in remote locations can be acquired via a network and modem.

List of Related Products (Programmable display GT series)





Product name	Description							Part No.
	LCD	Screen size	Power supply	Communication port	Color of front panel	SD memory card slot		
Tough GT03M-E	TFT monochrome LCD	3.5 inch	24 V DC	RS232C	Silver	Not available	AIG03MQ03DE	
Tough GT03T-E	TFT color LCD			RS422 / RS485			AIG03MQ05DE	
Tough GT32M-E	TFT monochrome LCD	5.7 inch	24 V DC	RS232C	Silver	Available	AIG03TQ13DE	
Tough GT32T-E	TFT color LCD			RS422 / RS485			AIG03TQ15DE	
				RS232C			AIG32MQ03DE	
				RS422 / RS485			AIG32MQ05DE	
				RS232C			AIG32TQ03DE	
				RS422 / RS485			AIG32TQ05DE	
GT02L	STN monochrome LCD (white backlight)	3.7 inch	5 V DC	RS232C	Black	Not available	AIG02LQ02D	
				RS422 / RS485			AIG02LQ04D	
GT02M	STN monochrome LCD (white/pink/red backlight)	3.8 inch	5 V DC	RS232C	Pure black	Not available	AIG02MQ02D	
					Hairline silver		AIG02MQ03D	
				RS422 / RS485	Pure black		AIG02MQ04D	
				Hairline silver	AIG02MQ05D			
			RS232C	Pure black	AIG02MQ12D			
				Hairline silver	AIG02MQ13D			
		24 V DC	RS422 / RS485	Pure black	AIG02MQ14D			
				Hairline silver	AIG02MQ15D			
			RS232C	Pure black	AIG02MQ22D			
				Hairline silver	AIG02MQ23D			
			RS422 / RS485	Pure black	AIG02MQ24D			
				Hairline silver	AIG02MQ25D			
GT02G	STN monochrome LCD (green/orange/red backlight)	3.8 inch	5 V DC	RS232C	Pure black	Not available	AIG02GQ02D	
					Hairline silver		AIG02GQ03D	
				RS422 / RS485	Pure black		AIG02GQ04D	
				Hairline silver	AIG02GQ05D			
			RS232C	Pure black	AIG02GQ12D			
				Hairline silver	AIG02GQ13D			
		24 V DC	RS422 / RS485	Pure black	AIG02GQ14D			
				Hairline silver	AIG02GQ15D			
			RS232C	Pure black	AIG02GQ22D			
				Hairline silver	AIG02GQ23D			
			RS422 / RS485	Pure black	AIG02GQ24D			
				Hairline silver	AIG02GQ25D			
GT05M	STN monochrome LCD (white/pink/red backlight)	3.5 inch	24 V DC	RS232C	Pure black	Available	AIG05MQ02D	
					Hairline silver	Available	AIG05MQ03D	
				RS422 / RS485	Pure black	Available	AIG05MQ04D	
					Hairline silver	Available	AIG05MQ05D	
GT05G	STN monochrome LCD (green/orange/red backlight)	3.5 inch	24 V DC	RS232C	Pure black	Available	AIG05GQ02D	
					Hairline silver	Available	AIG05GQ03D	
				RS422 / RS485	Pure black	Available	AIG05GQ04D	
					Hairline silver	Available	AIG05GQ05D	
GT05S	TFT color LCD	3.5 inch	24 V DC	RS232C	Pure black	Available	AIG05SQ02D	
					Hairline silver	Available	AIG05SQ03D	
				RS422 / RS485	Pure black	Available	AIG05SQ04D	
					Hairline silver	Available	AIG05SQ05D	
GT12M	STN monochrome LCD (white/pink/red backlight)	4.6 inch	24 V DC	RS232C	Pure black	Not available	AIG12MQ02D	
					Hairline silver	Not available	AIG12MQ03D	
				RS422 / RS485	Pure black	Not available	AIG12MQ04D	
					Hairline silver	Not available	AIG12MQ05D	
				RS232C	Pure black	Available	AIG12MQ12D	
					Hairline silver	Available	AIG12MQ13D	
				RS422 / RS485	Pure black	Available	AIG12MQ14D	
					Hairline silver	Available	AIG12MQ15D	
GT12G	STN monochrome LCD (green/orange/red backlight)	4.6 inch	24 V DC	RS232C	Pure black	Not available	AIG12GQ02D	
					Hairline silver	Not available	AIG12GQ03D	
				RS422 / RS485	Pure black	Not available	AIG12GQ04D	
					Hairline silver	Not available	AIG12GQ05D	
				RS232C	Pure black	Available	AIG12GQ12D	
					Hairline silver	Available	AIG12GQ13D	
				RS422 / RS485	Pure black	Available	AIG12GQ14D	
					Hairline silver	Available	AIG12GQ15D	
GT32M-R	TFT monochrome LCD	5.7 inch	24 V DC	RS232C	Pure black	Available	AIG32MQ02DR	
					Hairline silver	Available	AIG32MQ03DR	
				RS422 / RS485	Pure black	Available	AIG32MQ04DR	
					Hairline silver	Available	AIG32MQ05DR	
GT32T-R	TFT color LCD	5.7 inch	24 V DC	RS232C	Pure black	Available	AIG32TQ02DR	
					Hairline silver	Available	AIG32TQ03DR	
				RS422 / RS485	Pure black	Available	AIG32TQ04DR	
					Hairline silver	Available	AIG32TQ05DR	
NEW GT707	TFT color LCD	7 inch	24 V DC	RS232C	Black	Available	AIG707WCL1G2	
NEW Terminal GTWIN Ver.3 *1, *2	English, Simplified Chinese and Japanese			Terminal GTWIN CD-ROM			AIGSGT7EN	
Terminal GTWIN Ver.2 *1	Japanese version			Terminal GTWIN CD-ROM			AIGT8000V2	
	English version			Terminal GTWIN CD-ROM			AIGT8001V2	





*1 It can not be used with discontinued models of GT series.

*2 Some combinations can not perform simultaneous communication of GTWIN and FPWIN when using the pass through function. Please refer to our website for details.

Lineup (FP0, FP0R, FPΣ, and FP-X)

FPΣ	Control units
	<ul style="list-style-type: none"> ● C32 control unit (NPN Transistor output) AFP2543H (FPG-C32TH) ● C32 control unit (NPN Transistor output) Left-side expansion type, built-in linear interpolation and circular interpolation functions AFP2643H (FPG-C32T2H) ● C32 control unit (NPN Transistor output) With thermistor input AFP2543HTM (FPG-C32THTM) ● C32 control unit (NPN Transistor output) Left-side expansion type, built-in linear interpolation and circular interpolation functions, with thermistor input AFP2643HTM (FPG-C32T2HTM)
	<ul style="list-style-type: none"> ● C24 control unit (Relay output) Left-side expansion type, with thermistor input AFP2423HTM (FPG-C24R2HTM) ● C24 control unit (Relay output) Left-side expansion type AFP2423H (FPG-C24R2H)
	<ul style="list-style-type: none"> ● C28 control unit (PNP Transistor output) Left-side expansion type, built-in linear interpolation and circular interpolation functions AFP2653H (FPG-C28P2H) ● C28 control unit (PNP Transistor output) Left-side expansion type, built-in linear interpolation and circular interpolation functions, with thermistor input AFP2653HTM (FPG-C28P2HTM)





Left-side expansion possible up to 4 units

FP0R	Control units
10 points	Input: 6 points, Relay output: 4 points
Terminal block type	Molex connector type
	
AFP0RC10RS AFP0RC10CRS (with RS232C) AFP0RC10MRS (with RS485)	AFP0RC10RM AFP0RC10CRM (with RS232C)
14 points	Input: 8 points, Relay output: 6 points
Terminal block type	Molex connector type
	
AFP0RC14RS AFP0RC14CRS (with RS232C) AFP0RC14MRS (with RS485)	AFP0RC14RM AFP0RC14CRM (with RS232C)





Right-side expansion possible up to 3 units

Right-side expansion possible up to 3 units

FPΣ	Expansion units
	<ul style="list-style-type: none"> ● 64 points expansion I/O unit AFP4367 (FPG-XY64D2T) (NPN Transistor output) AFP4367 (FPG-XY64D2P) (PNP Transistor output) ● Positioning unit 1 axis, Transistor output AFP430 (FPG-PP11) 1 axis, Line driver output AFP432 (FPG-PP12) 2 axes, Transistor output AFP431 (FPG-PP21) 2 axes, Line driver output AFP433 (FPG-PP22) ● Positioning unit RTEX 2-axis unit AFP43610 (FPG-PN2AN) 4-axis unit AFP43620 (FPG-PN4AN) 8-axis unit AFP43630 (FPG-PN8AN) ● S-LINK unit AFP780 (FPG-SL) ● CC-Link slave unit AFP7943 (FPG-CCLS)

FP0R	Expansion units
8 points	Input: 8 points
MIL connector type	Input: 4 points, Relay output: 4 points
	Terminal block type
AFP0RE8X	
	Molex connector type
	
	AFP0RE8M
	Relay output: 8 points
Terminal block type	Transistor output: 8 points
	MIL connector type
AFP0RE8YRS	
	AFP0RE8YT AFP0RE8YP

Communication cassettes	
	<ul style="list-style-type: none"> ● 1 channel, RS232C AFP801 (FPG-COM1) ● 1 channel, RS485 (insulated) AFP803 (FPG-COM3) ● 2 channels, RS232C AFP802 (FPG-COM2) ● 1 channel, RS232C 1 channel, RS485 (insulated) AFP806 (FPG-COM4)

FP0R	Intelligent units	
Analog input unit Input: 4 channels	Analog input unit Input: 8 channels	Analog output unit Output: 4 channels
Terminal block type	Terminal block type	Terminal block type
		
AFP0RAD4	AFP0RAD8	AFP0RDA4
Analog I/O unit Input: 2 channels, Output: 1 channel	Analog I/O unit Input: 4 channels, Output: 2 channels	Thermocouple units
Terminal block type	Terminal block type	4-ch
		AFP0420 (FP0-TC4)
AFP0RA21	AFP0RA42	8-ch
		AFP0421 (FP0-TC8)

FP memory loader	Others
	<ul style="list-style-type: none"> Data clear type AFP8670 Data hold type AFP8671

*FP memory loader will be discontinued at the end of September, 2019.

16 points Input: 8 points, Transistor output: 8 points

MIL connector type



- AFP0RC16T**
- AFP0RC16P**
- AFP0RC16CT** (with RS232C)
- AFP0RC16CP** (with RS232C)
- AFP0RC16MT** (with RS485)
- AFP0RC16MP** (with RS485)

32 points Input: 16 points, Transistor output: 16 points

MIL connector type



T type



F type

- AFP0RC32T**
- AFP0RC32P**
- AFP0RC32CT** (with RS232C)
- AFP0RC32CP** (with RS232C)
- AFP0RC32MT** (with RS485)
- AFP0RC32MP** (with RS485)
- AFP0RT32CT** (with RS232C)
- AFP0RT32CP** (with RS232C)
- AFP0RT32MT** (with RS485)
- AFP0RT32MP** (with RS485)
- AFP0RF32CT** (with RS232C)
- AFP0RF32CP** (with RS232C)
- AFP0RF32MT** (with RS485)
- AFP0RF32MP** (with RS485)

Expansion possible up to 3 units

Expansion FP0 adapter



AFPX-EFP0

16 points

Input: 16 points MIL connector type Transistor output: 16 points MIL connector type Input: 8 points, Transistor output: 8 points MIL connector type



AFP0RE16X



AFP0RE16YT
AFP0RE16YP



AFP0RE16T
AFP0RE16P

32 points

Input: 16 points, Transistor output: 16 points

Input: 8 points, Relay output: 8 points

Terminal block type Molex connector type



AFP0RE16RS



AFP0RE16RM



AFP0RE32T
AFP0RE32P

Link and communication units

I/O link unit CC-Link slave unit FP WEBSERVER 2 unit



AFP0732
(FP0-IOL)



AFP07943
(FP0-CCLS)



AFP0611
(FP-WEB2)

*AFP0732 will be discontinued at the end of September, 2019.

KS1 Signal converter

C-NET adapter S2 type

Adapter to link with a host computer
With a 30 cm 1.18 in dedicated cable.
No power supply required.



AFP15402



AKS1202

FP-X

Control units

Relay output

DC power supply

AFPX-C14RD
8 points input of 24 V DC
6 points relay output of 2 A



Program capacity:
16 k steps
Potentiometer (volume)
input: 2 points

AC power supply

AFPX-C14R
8 points input of 24 V DC
6 points relay output of 2 A

Transistor output

DC power supply

AFPX-C14TD (NPN)
AFPX-C14PD (PNP)
8 points input of 24 V DC
0.5 A / 5 to 24 V DC
Transistor output: 6 points

AC power supply

AFPX-C14T (NPN)
AFPX-C14P (PNP)
8 points input of 24 V DC
0.5 A / 5 to 24 V DC
Transistor output: 6 points

DC power supply

AFPX-C30RD
16 points input of 24 V DC
14 points relay output of 2 A



Program capacity:
32 k steps
Potentiometer (volume)
input: 2 points
Equipped with a USB
communication port

AC power supply

AFPX-C30R
16 points input of 24 V DC
14 points relay output of 2 A

DC power supply

AFPX-C30TD (NPN)
AFPX-C30PD (PNP)
16 points input of 24 V DC
0.5 A / 5 to 24 V DC
Transistor output: 14 points

AC power supply

AFPX-C30T (NPN)
AFPX-C30P (PNP)
16 points input of 24 V DC
0.5 A / 5 to 24 V DC
Transistor output: 14 points

DC power supply

AFPX-C60RD
32 points input of 24 V DC
28 points relay output of 2 A



Program capacity:
32 k steps
Potentiometer (volume)
input: 4 points
Equipped with a USB
communication port

AC power supply

AFPX-C60R
32 points input of 24 V DC
28 points relay output of 2 A

DC power supply

AFPX-C60TD (NPN)
AFPX-C60PD (PNP)
32 points input of 24 V DC
0.5 A / 5 to 24 V DC
Transistor output: 28 points

AC power supply

AFPX-C60T (NPN)
AFPX-C60P (PNP)
32 points input of 24 V DC
0.5 A / 5 to 24 V DC
Transistor output: 28 points

FP-X

Expansion units

Input

AFPX-E16X
16 points input of 24 V DC



Remarks: Two or more units can't be connected serially because it can't supply the power to other units.

Relay output

AFPX-E14YR
14 points relay output of 2 A

DC power supply

AFPX-E16R
8 points input of 24 V DC
8 points relay output of 2 A

Transistor output

DC power supply

AFPX-E16T (NPN)
AFPX-E16P (PNP)
8 points input of 24 V DC
0.5 A / 5 to 24 V DC (NPN)
0.5 A / 24 V DC (PNP)
Transistor output: 8 points

DC power supply

AFPX-E30RD
16 points input of 24 V DC
14 points relay output of 2 A



Remarks: Possible to connect up to 8 units including E16 and Expansion FP0 adapter (AFPX-EFP0).

AC power supply

AFPX-E30R
16 points input of 24 V DC
14 points relay output of 2 A

DC power supply

AFPX-E30TD (NPN)
AFPX-E30PD (PNP)
16 points input of 24 V DC
0.5 A / 5 to 24 V DC (NPN)
0.5 A / 24 V DC (PNP)
Transistor output: 14 points

AC power supply

AFPX-E30T (NPN)
AFPX-E30P (PNP)
16 points input of 24 V DC
0.5 A / 5 to 24 V DC (NPN)
0.5 A / 24 V DC (PNP)
Transistor output: 14 points

FP-X

Add-on cassettes

Application cassettes

- AFPX-IN4T3** I/O
- AFPX-IN8** Input
- AFPX-TR8** Output
- AFPX-TR6P** Output
- AFPX-PLS*** Pulse I/O
- AFPX-AD2** Analog input
- AFPX-A21** Analog I/O
- AFPX-DA2** Analog output, 2 channels
- AFPX-TC2** Thermocouple input
- AFPX-RTD2** R.T.D. input
- AFPX-MRTC** Master memory cassette with a real-time clock



Communication cassettes

- AFPX-COM1** RS232C, 1 channel
- AFPX-COM2** RS232C, 2 channels
- AFPX-COM3** RS485 (insulated) / RS422 selectable, 1 channel
- AFPX-COM4** RS485 (insulated), 1 channel and RS232C, 1 channel
- AFPX-COM5** Ethernet, 1 channel + RS232C, 1 channel
- AFPX-COM6** RS485 (insulated), 2 channels

* Cannot be used with a transistor output type control unit.

Lineup (FP2SH)

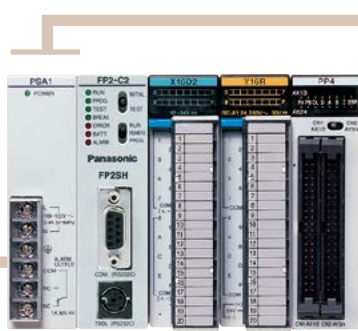

FP2SH

Power supply units



100 V AC,
2.5 A type
AFP2631
(FP2-PSA1)



200 V AC,
2.5 A type
AFP2632
(FP2-PSA2)



100 to 240 V AC,
5 A type
AFP2633
(FP2-PSA3)



24 V DC,
5 A type
AFP2634
(FP2-PSD2)

FP2SH

Conventional type and H type backplanes

(For use with both master and expansion backplanes. Only the 5-module type can not be used with expansion backplane.)



5-module type
AFP25005 (FP2-BP05)

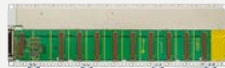

H type master backplanes
(11 modules): 8 slots
AFP25011MH (FP2-BP11MH)



7-module type
AFP25007 (FP2-BP07)



H type expansion backplanes
(10 modules): 8 slots
AFP25010EH (FP2-BP10EH)



9-module type
AFP25009 (FP2-BP09)



12-module type
AFP25012 (FP2-BP12)



14-module type
AFP25014 (FP2-BP14)

Units that occupy two modules

There is a two-module type in the power supply and CPU units.

Type	Product No.
Power supply unit, 5 A type	FP2-PSA3
	FP2-PSD2



Expansion cable
(60 cm 2.0 ft)
AFP2510
(FP2-EC)



Expansion cable
(2 m 6.6 ft)
AFP2512
(FP2-EC2)



Dummy unit
AFP2300
(FP2-DM)

FP2SH

CPU units



32 k steps
Standard type
AFP2221
(FP2-C2L)



60 k steps
Standard type
AFP2231
(FP2-C2)



60 k steps
For small PC card
AFP2235
(FP2-C2P)



120 k steps
For small PC card
AFP2255
(FP2-C3P)

Unit combinations

- Each unit is counted in the number of modules occupied. Most of the units occupy one module each. Some units occupy two modules each.
- Each unit is mounted on a backplane chosen depending on the total number of modules occupied by the all units used. The power supply unit and CPU unit must be mounted on the CPU backplane.
- Only one backplane other than the 5-module type can be added by using an expansion cable. Also, the 5-module type can not be used with expansion backplane. A power supply unit must be mounted on the expansion backplane.
- If the backplane is of the H type, up to three backplanes can be added.
- Most of the units can be used in any combination; however, some combinations are subject to constraints due to the unit type, current consumption, and other factors besides the above requirements. Please contact us for details.

FP2SH

I/O units



16 points DC input
AFP23023 (FP2-X16D2)
16 points NPN transistor output
AFP23403 (FP2-Y16T)
16 points PNP transistor output
AFP23503 (FP2-Y16P)
6 points Relay output
AFP23101 (FP2-Y6R)
16 points Relay output
AFP23103 (FP2-Y16R)



32 points DC input
AFP23064 (FP2-X32D2)
32 points NPN transistor output
AFP23404 (FP2-Y32T)
32 points PNP transistor output
AFP23504 (FP2-Y32P)



64 points DC input
AFP23067 (FP2-X64D2)
64 points NPN transistor output
AFP23407 (FP2-Y64T)
64 points PNP transistor output
AFP23507 (FP2-Y64P)
32 points input / 32 points NPN output mixed
AFP23467 (FP2-XY64D2T)
AFP23477 (FP2-XY64D7T)
32 points input / 32 points PNP output mixed
AFP23567 (FP2-XY64D2P)
AFP23577 (FP2-XY64D7P)

Analog I/O units



Voltage / Current input
AFP2400L
(FP2-AD8VI)



Multiple analog input
AFP2401
(FP2-AD8X)



R.T.D. input
AFP2402
(FP2-RTD)



Analog output
AFP2410
(FP2-DA4)

Positioning units RTEX



(2 axes) **AFP243610**
(FP2-PN2AN)



(4 axes) **AFP243620**
(FP2-PN4AN)



(8 axes) **AFP243630**
(FP2-PN8AN)

Positioning units



(2 axes)
AFP2432
(FP2-PP21)



(2 axes)
AFP2434
(FP2-PP22)

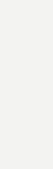

(4 axes)
AFP2433
(FP2-PP41)



(4 axes)
AFP2435
(FP2-PP42)

FP2SH

Optional memories



Expansion memory unit
AFP2208



IC memory card (2 MB)
AFP2209

FP memory loader



Data clear type
AFP8670
Data hold type
AFP8671

*FP memory loader will be discontinued at the end of September, 2019.

Positioning units interpolation type



(2 axes) **AFP243710**
(FP2-PP2T)

AFP243711
(FP2-PP2L)

(4 axes) **AFP243720**
(FP2-PP4T)

AFP243721
(FP2-PP4L)

Pulse I/O units



High-speed counter
AFP2441
(FP2-HSCT)



Pulse I/O
AFP2442 **AFP2452**
(FP2-PXYT) (FP2-PXYP)

Multi-communication unit



Multi-communication
AFP2465 (FP2-MCU)
* The communication blocks are available separately.

Link-related units



Multi-wire link
AFP2720 (FP2-MW)



Remote I/O slave unit
AFP2745 (FP2-RMS)

Link-related units



VE2-LINK
AFP279601 (FP2-VE2)



ET-LAN2
AFP27901 (FP2-ET2)



S-LINK
AFP2780 (FP2-SL2)



S-LINK V
SL-VFP2

FP2SH

AC servomotor MINAS Series



* Panasonic Corporation Motor business unit

FP2SH

Motor driver I/F terminal II



1-axis type

AFP8503



2-axis type

AFP8504

Part Number List

FP-e *The FP-e will be discontinued at the end of September, 2019.

Control units

Product name	Specifications	Calendar timer	Thermocouple input	Communication port	Product No.	Part No.
FP-e Control Unit	RS232C Calendar timer type	Available	Not available	RS232C	AFPE224305	AFPE224305
	RS232C Thermocouple input type	Available	Available	RS232C	AFPE214325	AFPE214325
	RS485 Basic type	Not available	Not available	RS485	AFPE224302	AFPE224302
	RS485 Thermocouple input type	Not available	Available	RS485	AFPE214322	AFPE214322

Options

Product name	Part No.	Product name	Part No.
Backup battery	AFPG804	Protective cover	AQM4803
Rubber gasket	ATC18002	Terminal screwdriver	AFP0806
Mounting frame	ATA4811	Terminal socket set (4 terminal blocks)	AFPE804
Panel cover (Black) 20 pcs	AFPE803		

FP0R

Control units

Product name	Built-in memory (Program capacity)	Specifications					Part No.	
		Number of I/O points	Power supply voltage	Input	Output	Connection type		
FP0R-C10 Control Unit	Flash EEPROM (16 k steps)	10	Input: 6 Output: 4	24 V DC	24 V DC Sink/Source (± common)	Relay: 2 A	Terminal block	AFP0RC10RS
					Molex connector	AFP0RC10RM		
FP0R-C10 Control Unit with RS232C port	Flash EEPROM (16 k steps)	10	Input: 6 Output: 4	24 V DC	24 V DC Sink/Source (± common)	Relay: 2 A	Terminal block	AFP0RC10CRS
					Molex connector	AFP0RC10CRM		
FP0R-C10 Control Unit with RS485 port	Flash EEPROM (16 k steps)	10	Input: 6 Output: 4	24 V DC	24 V DC Sink/Source (± common)	Relay: 2 A	Terminal block	AFP0RC10MRS
FP0R-C14 Control Unit	Flash EEPROM (16 k steps)	14	Input: 8 Output: 6	24 V DC	24 V DC Sink/Source (± common)	Relay: 2 A	Terminal block	AFP0RC14RS
					Molex connector	AFP0RC14RM		
FP0R-C14 Control Unit with RS232C port	Flash EEPROM (16 k steps)	14	Input: 8 Output: 6	24 V DC	24 V DC Sink/Source (± common)	Relay: 2 A	Terminal block	AFP0RC14CRS
					Molex connector	AFP0RC14CRM		
FP0R-C14 Control Unit with RS485 port	Flash EEPROM (16 k steps)	14	Input: 8 Output: 6	24 V DC	24 V DC Sink/Source (± common)	Relay: 2 A	Terminal block	AFP0RC14MRS
FP0R-C16 Control Unit	Flash EEPROM (16 k steps)	16	Input: 8 Output: 8	24 V DC	24 V DC Sink/Source (± common)	Transistor NPN: 0.2 A	MIL connector	AFP0RC16T
					Transistor PNP: 0.2 A	AFP0RC16P		
FP0R-C16 Control Unit with RS232C port	Flash EEPROM (16 k steps)	16	Input: 8 Output: 8	24 V DC	24 V DC Sink/Source (± common)	Transistor NPN: 0.2 A	MIL connector	AFP0RC16CT
					Transistor PNP: 0.2 A	AFP0RC16CP		
FP0R-C16 Control Unit with RS485 port	Flash EEPROM (16 k steps)	16	Input: 8 Output: 8	24 V DC	24 V DC Sink/Source (± common)	Transistor NPN: 0.2 A	MIL connector	AFP0RC16MT
					Transistor PNP: 0.2 A	AFP0RC16MP		
FP0R-C32 Control Unit	Flash EEPROM (32 k steps)	32	Input: 16 Output: 16	24 V DC	24 V DC Sink/Source (± common)	Transistor NPN: 0.2 A	MIL connector	AFP0RC32T
					Transistor PNP: 0.2 A	AFP0RC32P		
FP0R-C32 Control Unit with RS232C port	Flash EEPROM (32 k steps)	32	Input: 16 Output: 16	24 V DC	24 V DC Sink/Source (± common)	Transistor NPN: 0.2 A	MIL connector	AFP0RC32CT
					Transistor PNP: 0.2 A	AFP0RC32CP		
FP0R-C32 Control Unit with RS485 port	Flash EEPROM (32 k steps)	32	Input: 16 Output: 16	24 V DC	24 V DC Sink/Source (± common)	Transistor NPN: 0.2 A	MIL connector	AFP0RC32MT
					Transistor PNP: 0.2 A	AFP0RC32MP		
FP0R-T32 Control Unit with RS232C port and Real-time clock function	Flash EEPROM (32 k steps)	32	Input: 16 Output: 16	24 V DC	24 V DC Sink/Source (± common)	Transistor NPN: 0.2 A	MIL connector	AFP0RT32CT
					Transistor PNP: 0.2 A	AFP0RT32CP		
FP0R-T32 Control Unit with RS485 port and Real-time clock function	Flash EEPROM (32 k steps)	32	Input: 16 Output: 16	24 V DC	24 V DC Sink/Source (± common)	Transistor NPN: 0.2 A	MIL connector	AFP0RT32MT
					Transistor PNP: 0.2 A	AFP0RT32MP		
FP0R-F32 Control Unit with RS232C port and Battery-less automatic all data backup function	Flash EEPROM (32 k steps)	32	Input: 16 Output: 16	24 V DC	24 V DC Sink/Source (± common)	Transistor NPN: 0.2 A	MIL connector	AFP0RF32CT
					Transistor PNP: 0.2 A	AFP0RF32CP		
FP0R-F32 Control Unit with RS485 port and Battery-less automatic all data backup function	Flash EEPROM (32 k steps)	32	Input: 16 Output: 16	24 V DC	24 V DC Sink/Source (± common)	Transistor NPN: 0.2 A	MIL connector	AFP0RF32MT
					Transistor PNP: 0.2 A	AFP0RF32MP		

Note: A power cable (Part number: AFPG805) is supplied with the control units.

FP0

Control units

Product name	Built-in memory (Program capacity)	Specifications					Product No.	Part No.	
		Number of I/O points	Power supply voltage	Input	Output	Connection type			
FP0-S-LINK Control Unit with RS232C port	EEPROM (5 k steps)	128 (S-LINK section)	Input: 64 Output: 64	24 V DC	-	-	Terminal block	FP0-SL1	AFP02700

FPΣ

Control units

Product name	Built-in memory (Program capacity)	Specifications	Product No.	Part No.
FPΣ C32 Control Unit	Flash EEPROM (32 k steps)	Input 16 points DC, Transistor output (NPN) 16 points I/O control points when expanded: 128 points max.	FPG-C32TH	AFPG2543H
FPΣ C32 Left-side Expansion Type Control Unit	Flash EEPROM (32 k steps)	Input 16 points DC, Transistor output (NPN) 16 points I/O control points when expanded: 384 points max. Built-in linear interpolation and circular interpolation functions	FPG-C32T2H	AFPG2643H
FPΣ C24 Left-side Expansion Type Control Unit	Flash EEPROM (32 k steps)	Input 16 points DC, Relay output 8 points I/O control points when expanded: 376 points max. (transistor output)	FPG-C24R2H	AFPG2423H
FPΣ C28 Left-side Expansion Type Control Unit (PNP)	Flash EEPROM (32 k steps)	Input 16 points DC, Transistor output (PNP) 12 points I/O control points when expanded: 380 points max. Built-in linear interpolation and circular interpolation functions	FPG-C28P2H	AFPG2653H
FPΣ C32 Control Unit with Thermistor input	Flash EEPROM (32 k steps)	Input 16 points DC, Transistor output (NPN) 16 points I/O control points when expanded: 128 points max.	FPG-C32THTM	AFPG2543HTM
FPΣ C32 Left-side Expansion Type Control Unit with Thermistor input	Flash EEPROM (32 k steps)	Input 16 points DC, Transistor output (NPN) 16 points I/O control points when expanded: 384 points max. Built-in linear interpolation and circular interpolation functions	FPG-C32T2HTM	AFPG2643HTM
FPΣ C24 Left-side Expansion Type Control Unit with Thermistor input	Flash EEPROM (32 k steps)	Input 16 points DC, Relay output 8 points I/O control points when expanded: 376 points max. (transistor output)	FPG-C24R2HTM	AFPG2423HTM
FPΣ C28 Left-side Expansion Type Control Unit (PNP) with Thermistor input	Flash EEPROM (32 k steps)	Input 16 points DC, Transistor output (PNP) 12 points I/O control points when expanded: 380 points max. Built-in linear interpolation and circular interpolation functions	FPG-C28P2HTM	AFPG2653HTM

* Thermistors with a resistance from 200 Ω to 75 k Ω can be used.

Expansion I/O units for FPΣ and FP0R (right-side expansion types)

Product name	Specifications	Part No.
FP0R-E8 Expansion Unit	Input 8 points DC, MIL connector type	AFP0RE8X
	Input 4 points DC, Relay output 4 points, Terminal block type	AFP0RE8RS
	Input 4 points DC, Relay output 4 points, Connector type	AFP0RE8RM
	Relay output 8 points, Terminal block type	AFP0RE8YRS
	Transistor output (NPN) 8 points, MIL connector type	AFP0RE8YT
	Transistor output (PNP) 8 points, MIL connector type	AFP0RE8YP
FP0R-E16 Expansion Unit	Input 16 points DC, MIL connector type	AFP0RE16X
	Input 8 points DC, Relay output 8 points, Terminal block type	AFP0RE16RS
	Input 8 points DC, Relay output 8 points, Connector type	AFP0RE16RM
	Input 8 points DC, Transistor output (NPN) 8 points, MIL connector type	AFP0RE16T
	Input 8 points DC, Transistor output (PNP) 8 points, MIL connector type	AFP0RE16P
	Transistor output (NPN) 16 points, MIL connector type	AFP0RE16YT
	Transistor output (PNP) 16 points, MIL connector type	AFP0RE16YP
FP0R-E32 Expansion Unit	Input 16 points DC, Transistor output (NPN) 16 points, MIL connector type	AFP0RE32T
	Input 16 points DC, Transistor output (PNP) 16 points, MIL connector type	AFP0RE32P

Intelligent units for FPΣ and FP0R (right-side expansion types)

Product name	Specifications	Product No.	Part No.
FP0R Analog Input Unit	<Input specifications> Number or channels: 4 channels Voltage -10 to +10 V, -5 to +5 V, 0 to +10 V, 0 to +5 V (Resolution: 1/16,000) Current 0 to 20 mA (Resolution: 1/16,000)	-	NEW AFP0RAD4
FP0R Analog Input Unit	<Input specifications> Number or channels: 8 channels Voltage -10 to +10 V, -5 to +5 V, 0 to +10 V, 0 to +5 V (Resolution: 1/16,000) Current 0 to 20 mA (Resolution: 1/16,000)	-	NEW AFP0RAD8
FP0R Analog I/O Unit	<Input specifications> Number or channels: 2 channels Voltage -10 to +10 V, -5 to +5 V, 0 to +10 V, 0 to +5 V (Resolution: 1/16,000) Current 0 to 20 mA (Resolution: 1/16,000)	-	NEW AFP0RA21
	<Output specifications> Number or channels: 1 channel Voltage -10 to +10 V, -5 to +5 V, 0 to +10 V, 0 to +5 V (Resolution: 1/16,000) Current 0 to 20 mA, 4 to 20 mA (Resolution: 1/16,000)		
FP0R Analog I/O Unit	<Input specifications> Number or channels: 4 channels Voltage -10 to +10 V, -5 to +5 V, 0 to +10 V, 0 to +5 V (Resolution: 1/16,000) Current 0 to 20 mA (Resolution: 1/16,000)	-	NEW AFP0RA42
	<Output specifications> Number or channels: 2 channels Voltage -10 to +10 V, -5 to +5 V, 0 to +10 V, 0 to +5 V (Resolution: 1/16,000) Current 0 to 20 mA, 4 to 20 mA (Resolution: 1/16,000)		
FP0R Analog Output Unit	<Output specifications> Number or channels: 4 channels Voltage -10 to +10 V, -5 to +5 V, 0 to +10 V, 0 to +5 V (Resolution: 1/16,000) Current 0 to 20 mA, 4 to 20 mA (Resolution: 1/16,000)	-	NEW AFP0RA44
FP0 Thermocouple Unit	K, J, T, R thermocouple, Resolution: 0.1 °C 32.18 °F, 4-ch	FP0-TC4	AFP0420
	K, J, T, R thermocouple, Resolution: 0.1 °C 32.18 °F, 8-ch	FP0-TC8	AFP0421
FP WEB-SERVER2	Unit for connecting FP series RS232C interface and Ethernet Web-server function and E-mail sending function, Compatible with 100BASE-TX (100 Mbps).	FP0-WEB2	AFP0611
Control FP WEB Configurator Tool 2	Setting tool software for FP Web-server 2	Japanese version	AFPS30120 AFPS30120
		English version	AFPS30520 AFPS30520
FP0 I/O Link Unit	This is a link unit designed to connect FP0 as a station to MEWNET-F (our remote I/O system).	FP0-IOL	AFP0732
FP0 CC-link Slave Unit (Note)	Unit to connect to FP0 CC-link	FP0-CCLS	AFP07943
KS1 Signal Converter	RS232C/RS485 data can be easily monitored by LAN.	-	AKS1202

Note: It will be discontinued at the end of September, 2019.

Expansion units for FPΣ (left-side expansion type)

Product name	Specifications	Product No.	Part No.
FPΣ 64 points Expansion I/O Unit	Input 32 points DC, Transistor output (NPN) 32 points, Maximum possible expansion is with a total of 4 units to the left side of the FPΣ control units	FPG-XY64D2T	AFPG3467
	Input 32 points DC, Transistor output (PNP) 32 points, Maximum possible expansion is with a total of 4 units to the left side of the FPΣ control units	FPG-XY64D2P	AFPG3567

FPΣ

Intelligent units for FPΣ (left-side expansion types)

Product name	Specifications	Product No.	Part No.
FPΣ Positioning Unit	Pulse output type 1 axis, Transistor output	FPG-PP11	AFPG430
FPΣ Positioning Unit	Pulse output type 1 axis, Line driver output	FPG-PP12	AFPG432
FPΣ Positioning Unit	Pulse output type 2 axes, Transistor output	FPG-PP21	AFPG431
FPΣ Positioning Unit	Pulse output type 2 axes, Line driver output	FPG-PP22	AFPG433
FPΣ Positioning Unit RTEX	Network type 2-axis type	FPG-PN2AN	AFPG43610
FPΣ Positioning Unit RTEX	Network type 4-axis type	FPG-PN4AN	AFPG43620
FPΣ Positioning Unit RTEX	Network type 8-axis type	FPG-PN8AN	AFPG43630
Control Configurator PM	Dedicated tool software for positioning unit RTEX, Japanese version	-	AFPS66110
	Dedicated tool software for positioning unit RTEX, English version	-	AFPS66510
FPΣ CC-Link Slave Unit	Unit to connect to CC-Link	FPG-CCLS	AFPG7943
FPΣ S-LINK Unit	Unit to connect to SUNX S-LINK I/O devices	FPG-SL	AFPG780

Communication cassettes

Product name	Specifications	Product No.	Part No.
FPΣ Communication Cassette 1 channel, RS232C type	Cassette for control unit installation. Enables communications with devices with RS232C interface.	FPG-COM1	AFPG801
FPΣ Communication Cassette 2 channels, RS232C type	Cassette for control unit installation. Enables communications with devices with RS232C interface.	FPG-COM2	AFPG802
FPΣ Communication Cassette 1 channel, RS485 type	Cassette for control unit installation. PLC linking between FPΣs or communication with devices with RS485 interface possible.	FPG-COM3	AFPG803
FPΣ Communication Cassette 1 channel, RS232C and 1 channel, RS485 type	Cassette for control unit installation. Enables communications with devices with RS232C interface and RS485 interface.	FPG-COM4	AFPG806

Options for FP0 and FPΣ

C-NET

Product name	Specifications	Part No.
For connection with a PLC (with cable) C-NET Adapter S2 type	Connects FP0 to C-NET. Connects the FP0 programmer with the supplied cable. Requires no power supply	AFP15402

Options and maintenance parts

Product name	Specifications	Part No.
Backup battery for FPΣ	Battery for full-time back up of operation memory and clock/calendar function	AFPG804
FPΣ High capacity battery holder	Battery does not come with battery holder. Purchase a commercially available CR123A battery.	AFPG807
FP0 Slim 30 type mounting plate	Plastic plate to mount FPΣ units and FPΣ expansion units on a panel (including 10 pieces)	AFP0811
FP0 Slim type mounting plate	Plastic plate to mount FP0 expansion units on a panel (including 10 pieces)	AFP0803
Power cable for FP0	Included with FP0 unit. Maintenance part. 1 m 3.3 ft length (including 1 piece)	AFP0581
Power cable for FPΣ	Included with control unit. Maintenance part. 1 m 3.3 ft length	AFPG805
FP memory loader (Note)	Data clear type	AFP8670
	Data hold type	AFP8671
Terminal screwdriver	Relay output type Necessary when wiring terminals block (Phoenix).	AFP0806
Multi-wire connector pressure contact tool	Necessary when wiring transistor output type connectors.	AXY52000FP
I/O cable for relay output molex type	Loose-wiring cable (9 leads) AWG20, with Molex socket attached at one end, 0.5 mm ² , 1 set: 2 cables (blue & white).	Length: 1 m 3.3 ft Length: 3 m 9.8 ft AFP0551 AFP0553
I/O cable for transistor output type	Wire-pressed terminal cable (10 leads) AWG22, 0.3 mm ² with connectors attached at one end, 1 set: 2 cables (blue & white).	Length: 1 m 3.3 ft Length: 3 m 9.8 ft AFP0521 AFP0523
Connector set for flat cable (10 leads)	If you are using flat cable connector, request the part specified below for a connector with an asymmetrical design to prevent mistaken polarity. (including 4 pieces)	AFP0808
Terminal socket	Attaches to relay output and terminal block type. Maintenance part. (2 sockets per pack)	AFP0802
Molex socket	Attaches to relay output and Molex connector types. Maintenance part. (2 sockets per pack)	AFP0801
Wire-press socket (10 leads)	Attaches to transistor output type. Maintenance part. (2 sockets per pack)	AFP0807

Note: FP memory loader will be discontinued at the end of September, 2019.

Motor driver I/F terminal II

Product name	Specifications	Part No.
Motor driver I/F terminal II 1-axis type	I/F terminal for connecting the MINAS series and FPΣ positioning unit /	AFP8503
Motor driver I/F terminal II 2-axis type	FP2 multi function type positioning unit.	AFP8504
Exclusive cable for MINAS A4 / A5 series, 1 m 3.281 ft	Cable for connecting the MINAS A4 / A5 series and motor driver I/F terminal II.	AFP85151
Exclusive cable for MINAS A4 / A5 series, 2 m 6.562 ft		AFP85152
Connection cable for positioning unit, 0.5 m 1.640 ft	Cable for connecting the FPΣ positioning unit / FP2 multi function type positioning unit and	AFP85100
Connection cable for positioning unit, 1 m 3.281 ft	motor driver I/F terminal II.	AFP85101

FP-X

Control units

	Product name	Power supply	Specifications	Program capacity	Potentiometer	USB port	Part No.
Relay output	FP-X C14R	100 to 240 V AC	8-point input of 24 V DC, 6-point relay output of 2 A	16 k steps	2-point	Not available	AFPX-C14R
	FP-X C14RD	24 V DC	8-point input of 24 V DC, 6-point relay output of 2 A	16 k steps	2-point	Not available	AFPX-C14RD
	FP-X C30R	100 to 240 V AC	16-point input of 24 V DC, 14-point relay output of 2 A	32 k steps	2-point	Available	AFPX-C30R
	FP-X C30RD	24 V DC	16-point input of 24 V DC, 14-point relay output of 2 A	32 k steps	2-point	Available	AFPX-C30RD
	FP-X C60R	100 to 240 V AC	32-point input of 24 V DC, 28-point relay output of 2 A	32 k steps	4-point	Available	AFPX-C60R
	FP-X C60RD	24 V DC	32-point input of 24 V DC, 28-point relay output of 2 A	32 k steps	4-point	Available	AFPX-C60RD
Transistor output	FP-X C14T	100 to 240 V AC	8-point input of 24 V DC, 0.5 A / 5 to 24 V DC, 6-point output of transistor (NPN)	16 k steps	2-point	Not available	AFPX-C14T
	FP-X C14TD	24 V DC	8-point input of 24 V DC, 0.5 A / 5 to 24 V DC, 6-point output of transistor (NPN)	16 k steps	2-point	Not available	AFPX-C14TD
	FP-X C14P	100 to 240 V AC	8-point input of 24 V DC, 0.5 A / 24 V DC, 6-point output of transistor (PNP)	16 k steps	2-point	Not available	AFPX-C14P
	FP-X C14PD	24 V DC	8-point input of 24 V DC, 0.5 A / 24 V DC, 6-point output of transistor (PNP)	16 k steps	2-point	Not available	AFPX-C14PD
	FP-X C30T	100 to 240 V AC	16-point input of 24 V DC, 0.5 A / 5 to 24 V DC, 14-point output of transistor (NPN)	32 k steps	2-point	Available	AFPX-C30T
	FP-X C30TD	24 V DC	16-point input of 24 V DC, 0.5 A / 5 to 24 V DC, 14-point output of transistor (NPN)	32 k steps	2-point	Available	AFPX-C30TD
	FP-X C30P	100 to 240 V AC	16-point input of 24 V DC, 0.5 A / 24 V DC, 14-point output of transistor (PNP)	32 k steps	2-point	Available	AFPX-C30P
	FP-X C30PD	24 V DC	16-point input of 24 V DC, 0.5 A / 24 V DC, 14-point output of transistor (PNP)	32 k steps	2-point	Available	AFPX-C30PD
	FP-X C60T	100 to 240 V AC	32-point input of 24 V DC, 0.5 A / 5 to 24 V DC, 28-point output of transistor (NPN)	32 k steps	4-point	Available	AFPX-C60T
	FP-X C60TD	24 V DC	32-point input of 24 V DC, 0.5 A / 5 to 24 V DC, 28-point output of transistor (NPN)	32 k steps	4-point	Available	AFPX-C60TD
	FP-X C60P	100 to 240 V AC	32-point input of 24 V DC, 0.5 A / 24 V DC, 28-point output of transistor (PNP)	32 k steps	4-point	Available	AFPX-C60P
	FP-X C60PD	24 V DC	32-point input of 24 V DC, 0.5 A / 24 V DC, 28-point output of transistor (PNP)	32 k steps	4-point	Available	AFPX-C60PD

Note: The 24 V DC inputs of all units are bi-directional (sink/source) inputs.

Expansion units

	Product name	Power supply	Specifications	Part No.
Input	FP-X E16X Expansion Input Unit	(Power is supplied from the left-side unit.)	16-point input of 24 V DC	AFPX-E16X
	FP-X E14YR Expansion Output Unit	(Power is supplied from the left-side unit.)	14-point output of 24 V DC	AFPX-E14YR
Relay output	FP-X E16R Expansion I/O Unit	(Power is supplied from the left-side unit.)	8-point input of 24 V DC, 8-point relay output of 2 A Remarks; Two or more units can't be connected serially because it can't supply the power to other units. With an 8 cm 3.15 in extension cable	AFPX-E16R
	FP-X E30R Expansion I/O Unit	100 to 240 V AC	16-point input of 24 V DC, 14-point relay output of 2 A Remarks; Possible to connect up to 8 units including E16 and AFPX-EFP0. With an 8 cm 3.15 in extension cable	AFPX-E30R
	FP-X E30RD Expansion I/O Unit	24 V DC	16-point input of 24 V DC, 14-point relay output of 2 A Remarks; Possible to connect up to 8 units including E16 and AFPX-EFP0. With an 8 cm 3.15 in extension cable	AFPX-E30RD
Input and output	FP-X E16T Expansion I/O Unit	(Power is supplied from the left-side unit.)	8-point input of 24 V DC, 0.5 A / 5 to 24 V DC, 8-point output of transistor (NPN) Remarks; Two or more units can't be connected serially because it can't supply the power to other units. With an 8 cm 3.15 in extension cable	AFPX-E16T
	FP-X E16P Expansion I/O Unit	(Power is supplied from the left-side unit.)	8-point input of 24 V DC, 0.5 A / 24 V DC, 8-point output of transistor (PNP) Remarks; Two or more units can't be connected serially because it can't supply the power to other units. With an 8 cm 3.15 in extension cable	AFPX-E16P
	FP-X E30TD Expansion I/O Unit	24 V DC	16-point input of 24 V DC, 0.5 A / 5 to 24 V DC, 14-point output of transistor (NPN) Remarks; Possible to connect up to 8 units including E16 and AFPX-EFP0. With an 8 cm 3.15 in extension cable	AFPX-E30TD
	FP-X E30T Expansion I/O Unit	100 to 240 V AC	16-point input of 24 V DC, 0.5 A / 5 to 24 V DC, 14-point output of transistor (NPN) Remarks; Possible to connect up to 8 units including E16 and AFPX-EFP0. With an 8 cm 3.15 in extension cable	AFPX-E30T
	FP-X E30PD Expansion I/O Unit	24 V DC	16-point input of 24 V DC, 0.5 A / 24 V DC, 14-point output of transistor (PNP) Remarks; Possible to connect up to 8 units including E16 and AFPX-EFP0. With an 8 cm 3.15 in extension cable	AFPX-E30PD
	FP-X E30P Expansion I/O Unit	100 to 240 V AC	16-point input of 24 V DC, 0.5 A / 24 V DC, 14-point output of transistor (PNP) Remarks; Possible to connect up to 8 units including E16 and AFPX-EFP0. With an 8 cm 3.15 in extension cable	AFPX-E30P
	Expansion FP0 Adapter	24 V DC	Up to three FP0 expansion units can be connected via an adapter. With an 8 cm 3.15 in extension cable and power cable	AFPX-EFP0

Note: The 24 V DC inputs of all units are bi-directional (sink/source) inputs.

FP-X

Add-on cassettes

Product name	Specifications	Part No.
FP-X I/O cassette	4-point input of 24 V DC, bi-directional (sink/source), 3-point output of NPN transistor 0.3 A/24 V DC	AFPX-IN4T3
FP-X Input cassette	8-point input of 24 V DC, bi-directional (sink/source)	AFPX-IN8
FP-X Output cassette	8-point output of NPN transistor, 0.3 A / 24 V DC	AFPX-TR8
	6-point output of PNP transistor, 0.5 A / 24 V DC	AFPX-TR6P
FP-X Pulse I/O cassette	High-speed counter input: single-phase 2 channels, each 80 k Hz or two-phase 1 channel, 30 k Hz Pulse output: one axis 100 kHz / channel (Use restriction is applied for a two-unit installation) Cannot be used with a transistor output type control unit.	AFPX-PLS
FP-X Analog input cassette	2-point analog input, 0 to 10 V / 0 to 20 mA, 12-bit, 2 ms / 2 channels (non-insulated)	AFPX-AD2
FP-X Analog output cassette	2-point analog output, 0 to 10 V / 0 to 20 mA, 12-bit, 2 ms / 2 channels (insulated)	AFPX-DA2
FP-X Analog I/O cassette	2-point analog input, 0 to 5 V / 0 to 10 V or 0 to 20 mA, 12-bit, 2 ms / 2 channels (insulated) 1 point analog output, 0 to 10 V / 0 to 20 mA, 12-bit, 1 ms / 1 channel (insulated)	AFPX-A21
FP-X Thermocouple input cassette	2-point thermocouple input, K / J type, Resolution: 0.2 °C 32.36 °F , 200 ms / 2 channels (between channels: insulated)	AFPX-TC2
FP-X R.T.D. input cassette	2-points R.T.D. input, Pt100, Resolution: 0.1 °C 32.18 °F , 200 ms (between channels: insulated)	AFPX-RTD2
FP-X Master memory cassette with a real-time clock	Master memory: Capable of storing all program steps and comments simultaneously. Storage of FPWIN Pro source files Real time clock: Year, month, day, hour, minute, second, day of week (optional battery required)	AFPX-MRTC
FP-X COM1 Communication cassette	RS232C 1 channel, RS and CS control signal equipped (non-insulated)	AFPX-COM1
FP-X COM2 Communication cassette	RS232C 2 channels (non-insulated)	AFPX-COM2
FP-X COM3 Communication cassette	RS485 / RS422 selectable 1 channel (insulated)	AFPX-COM3
FP-X COM4 Communication cassette	RS485 1 channel (insulated) and RS232C 1 channel (non-insulated)	AFPX-COM4
FP-X COM5 Communication cassette	Ethernet 1 channel (10BASE-T, 100BASE-TX) and RS232C 1 channel (non-insulated)	AFPX-COM5
FP-X COM6 Communication cassette	RS485 2 channels (insulated)	AFPX-COM6
Control Configurator WD	Tool software for setting the Ethernet port of the COM5 communication cassette (Can be downloaded free of charge from our website)	

Options and maintenance parts

Product name	Specifications	Part No.
FP-X Backup battery	Battery for backing up the operation memory and real-time clock	AFPX-BATT
FP-X Expansion cable	Expansion unit connection cable, 8 cm 3.15 in	AFPX-EC08
	Expansion unit connection cable, 30 cm 11.81 in	AFPX-EC30
	Expansion unit connection cable, 80 cm 31.50 in	AFPX-EC80
FP-X Terminal block	Terminal block for C30, C60 and E30, 21 pins, cover with no marking, four units included	AFPX-TAN1

FP2SH

CPU units (Built-in RAM)

Product name	Operation speed	Built-in RAM	Optional memory			Other		Product No.	Part No.
			Expansion RAM	ROM	IC memory card	Clock/calendar	Comment memory		
FP2SH	From 0.03 μs	32 k steps	Not available	Available (separately sales)	Not available	Available (built-in)	Available (built-in)	FP2-C2L	AFP2221
		60 k steps	Not available	Available (separately sales)	Not available	Available (built-in)	Available (built-in)	FP2-C2	AFP2231
		60 k type with IC memory card interface	Not available	Available (built-in)	Available (separately sales)	Available (built-in)	Available (built-in)	FP2-C2P	AFP2235
		120 k type with IC memory card interface	Not available	Available (built-in)	Available (separately sales)	Available (built-in)	Available (built-in)	FP2-C3P	AFP2255

FP2SH

Optional memories for FP2SH

Product name		Specifications	Product No.	Part No.
Expansion memory unit		Memory board in which the nonvolatile memory was mounted beforehand	AFP2208	AFP2208
IC memory card (Small PC card) for FP2SH CPU unit with IC memory card interface	SRAM	Perfect for data memory Can also be used for program backup. Battery backups.	AFP2209	AFP2209

Backplanes

Product name		Specifications	Product No.	Part No.
FP2 Backplane	Conventional type	5-module type (for master)	FP2-BP05	AFP25005
		7-module type (for master and expansion)	FP2-BP07	AFP25007
		9-module type (for master and expansion)	FP2-BP09	AFP25009
		12-module type (for master and expansion)	FP2-BP12	AFP25012
		14-module type (for master and expansion)	FP2-BP14	AFP25014
	H type	8 slots (for master)	FP2-BP11MH	AFP25011MH
		8 slots (for expansion)	FP2-BP10EH	AFP25010EH
FP2 Expansion Cable		0.6 m 2.0 ft	FP2-EC	AFP2510
		2 m 6.6 ft	FP2-EC2	AFP2512

Power supply units

Product name		Specifications	Product No.	Part No.
FP2 Power Supply Unit		Input: 100 to 120 V AC, Output: 2.5 A	FP2-PSA1	AFP2631
		Input: 200 to 240 V AC, Output: 2.5 A	FP2-PSA2	AFP2632
		Input: 100 to 240 V AC, Output: 5 A	FP2-PSA3	AFP2633
		Input: 24 V DC, Output: 5 A	FP2-PSD2	AFP2634

I/O units

Product name	Type	Number of point	Connection method	Specifications	Product No.	Part No.
FP2 Input Unit	DC input	16 points	Terminal block	12 to 24 V DC	FP2-X16D2	AFP23023
		32 points	Connector	24 V DC	FP2-X32D2	AFP23064
		64 points	Connector	24 V DC	FP2-X64D2	AFP23067
FP2 Output Unit	Relay output	6 points	Terminal block	5 A, 2 points per one common	FP2-Y6R	AFP23101
		16 points	Terminal block	2 A, 8 points per one common	FP2-Y16R	AFP23103
	Transistor output NPN	16 points	Terminal block	0.5 A (12 to 24 V DC), 0.1 A (5 V DC)	FP2-Y16T	AFP23403
		32 points	Connector	0.1 A (12 to 24 V DC), 50 mA (5 V DC)	FP2-Y32T	AFP23404
		64 points	Connector	0.1 A (12 to 24 V DC), 50 mA (5 V DC)	FP2-Y64T	AFP23407
	Transistor output PNP	16 points	Terminal block	0.5 A (12 to 24 V DC), 0.1 A (5 V DC)	FP2-Y16P	AFP23503
		32 points	Connector	0.1 A (12 to 24 V DC), 50 mA (5 V DC)	FP2-Y32P	AFP23504
		64 points	Connector	0.1 A (12 to 24 V DC), 50 mA (5 V DC)	FP2-Y64P	AFP23507
	FP2 I/O Mixed Unit	DC input, Transistor output NPN	Input: 32 points Output: 32 points	Connector	Input: 24 V DC Output: 0.1 A (12 to 24 V DC), 50 mA (5 V DC)	FP2-XY64D2T
Input: 24 V DC Output: 0.1 A (12 to 24 V DC), 50 mA (5 V DC) with ON pulse catch input					FP2-XY64D7T	AFP23477
DC input, Transistor output PNP		Input: 32 points Output: 32 points	Connector	Input: 24 V DC Output: 0.1 A (12 to 24 V DC), 50 mA (5 V DC)	FP2-XY64D2P	AFP23567
				Input: 24 V DC Output: 0.1 A (12 to 24 V DC), 50 mA (5 V DC) with ON pulse catch input	FP2-XY64D7P	AFP23577

* Pressure welding socket is supplied. A special tool (Part No.: AXY52000FP) is needed for connection. Please purchase separately if you are using a terminal or flat cable socket.

Intelligent units for Analog I/O

Product name		Specifications	Number of I/O points	Product No.	Part No.
FP2 Analog Input Unit	FP2-AD8VI	Between channels: not insulated, Voltage: 1 to 5 V, ±10 V Current: 4 to 20 mA, ±20 mA	Analog input: 8 channels	FP2-AD8VI	AFP2400L
	FP2-AD8X	Between channels: insulated, Voltages, Currents, Thermocouples, R.T.D. (Resistance Thermometer Devices)	Analog input: 8 channels	FP2-AD8X	AFP2401
	FP2-RTD	R.T.D. type: Pt100, JPt100, JPt1000 type	R.T.D. input: 8 channels	FP2-RTD	AFP2402
FP2 Analog Output Unit		Voltage: -10 to +10 V, Current: 0 to 20 mA, Resolution: 1/4,096	Analog output: 4 channels	FP2-DA4	AFP2410