



Chipsmall Limited consists of a professional team with an average of over 10 year of expertise in the distribution of electronic components. Based in Hongkong, we have already established firm and mutual-benefit business relationships with customers from,Europe,America and south Asia,supplying obsolete and hard-to-find components to meet their specific needs.

With the principle of “Quality Parts,Customers Priority,Honest Operation,and Considerate Service”,our business mainly focus on the distribution of electronic components. Line cards we deal with include Microchip,ALPS,ROHM,Xilinx,Pulse,ON,Everlight and Freescale. Main products comprise IC,Modules,Potentiometer,IC Socket,Relay,Connector.Our parts cover such applications as commercial,industrial, and automotives areas.

We are looking forward to setting up business relationship with you and hope to provide you with the best service and solution. Let us make a better world for our industry!



Contact us

Tel: +86-755-8981 8866 Fax: +86-755-8427 6832

Email & Skype: info@chipsmall.com Web: www.chipsmall.com

Address: A1208, Overseas Decoration Building, #122 Zhenhua RD., Futian, Shenzhen, China



New Multi-functional & Economical PLC

Body equipped with combined relay and transistor output



L30R

Super-high processing speed

80 ns/step (0 to 3000 steps for ST command)

Number of I/O points expandable up to 216 max.

When using FP0R extension unit*2

Combined output (Ry+Tr)

Tr: 4 points, 0.5 A (Only 2 points for L14)

Built-in 2-axis pulse output

50 kHz max.*1

Built-in 2-channel multi-functional analog input

Voltage, thermistor and potentiometer input *2

Built-in calendar/clock*2

Built-in RS485 communication port*3

*1) L14 is 1-axis/20 kHz max. and L30 is 2-axis/20 kHz max.

*2) Only for L40R, L40MR, L60R and L60MR models

*3) Only for L40MR and L60MR models



L14R



L40R/L40MR



L60R/L60MR

Super-high Processing Speed

Super-high speed of 80 ns/step for 0 to 3000 steps (ST command). 580 ns/step processing speed for 3001 steps or more (Only for L40 and L60).

Program Memory

L14 and L30: 2.5 k steps
L40 and L60: 8 k steps

The Maximum Number of I/O Points

One control unit can be connected with up to 3 expansion units. Therefore, the maximum number can reach 150 points.

In addition, if the expansion FP0 adaptor is used, the maximum number can reach 216 points when the FP0R expansion unit is used. (Only for L40R, L40MR, L60R and L60MR)

Maximum 2-channel Communication Port

One RS232C programming port is equipped on the body. And RS485 communication port is also built in L40MR and L60MR.

Modbus-RTU

Non-program communication with the devices (such as the temperature controller and the inverter etc.) using global universal industry standard Modbus-RTU (binary) can be realized simply.

PLC Link

If L40MR and L60MR are used, the sharing of bit data and word data among 16 PLCs (max.) can be realized.

Computer Link

Non-program communication with the devices (such as the display, image processor, temperature controller and wattmeter etc.) using Panasonic open protocol "MEWTOCOL" can be realized simply.

Universal Serial Communication

It can generate or send the corresponding commands according to the communication protocol used by the pairing device. In addition, it can also receive the flow data, such as the data from the measuring instrument, bar code reader and RF-ID etc.

FP-X0

Rich Functions, High Cost-effective.

Strong Lineup, Wide Application.



6 Kinds of Control Units

L14R, L30R, L40R and L60R: Ry+Tr, AC
 L40MR, L60MR: Ry+Tr, RS485, AC

11 Kinds of Expansion Units (FP-X)

(16 points) × (Ry, NPN, PNP)

(30 points) × (Ry, NPN, PNP) (AC, DC)

Specific unit for input (E16X)

Specific unit for output (E14YR)

3 units max. can be added.

E16X, E16T, E16P upgraded to Ver.3 or later can be connected (The number of connected units is limited.)

56 Kinds of Combinations (of I/O number)

14 to 150 points (FP0R expansion units excluded)

Built-in 2-axis Pulse Output Function

L14 is 1-axis pulse output, while L30/L40/L60 are 2-axis, and the pulse output function is built in the body of the controller. Built-in 2-axis type can realize linear interpolation (Only for L40 and L60).

Analog Input Function

Multi-functional analog input (10 bit, 2-channel)

Voltage input (0 to 10 V), thermistor input and adjustable potentiometer input.



Basic Performance (Expansion)

Programmable Controller **FP-X0**

■Plenty of I/O Points -150 points max.

(If further expansion is made to FP0R expansion unit, the number can be expanded to 216 points max.)

If the customer can not predict the number of I/O points needed by his machineries and devices in the future, he will feel hesitant and uncomfortable. But, the I/O number of FP-X0 can reach 150 points max. by using the FP-X expansion unit. Therefore, the customer's discomfort and hesitation can be eliminated. And the number of I/O points can be expanded to 216 by using the FP0R expansion unit. (L14R and L30R don't have the expansion function, so they can not be expanded.)

•The maximum number of expansion unit is up to 3 units



The cable between the units can be bent to realize the side-by-side installation, thus saving the installation space.

[Expansion]

•E16X, E16T and E16P upgraded to Ver.3 or later can be connected in series up to 3 units. But, E14 and E16 expansion units can not be connected at the right sides of E16X/E16T/E16P (Ver.2 earlier) or E16R/E14YR.

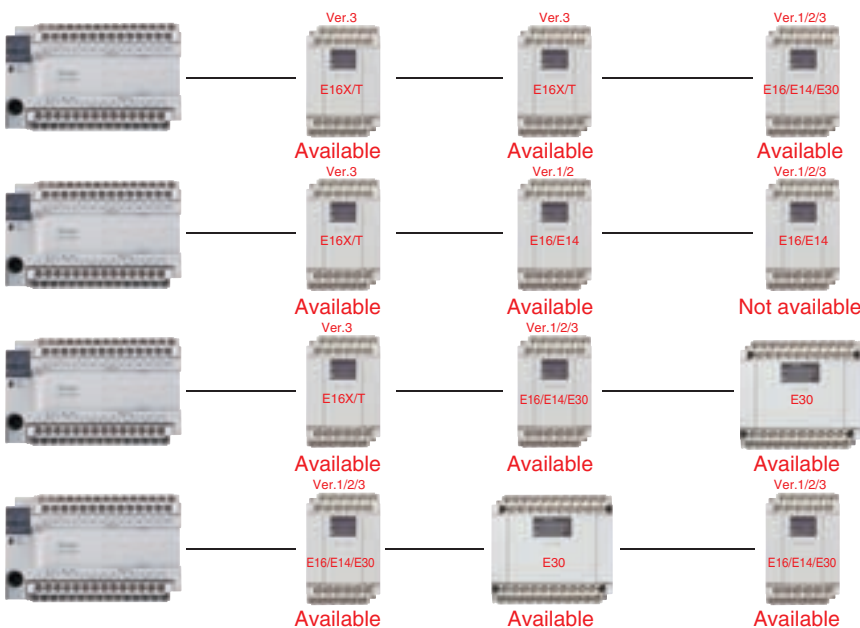

Product name	Power supply	Specifications	Model
FP-X E16X	-	DC input, 16 points	AFPX-E16X
FP-X E14YR	-	2A relay output, 14 points	AFPX-E14YR
FP-X E16R	-	DC input, 8 points 2 A relay output, 8 points	AFPX-E16R
FP-X E30R	AC	16-point DC input 14-point 2A relay output	AFPX-E30R
FP-X E30RD	DC	16-point DC input 14-point 2A relay output	AFPX-E30RD
FP-X E16T	-	8-point DC input 8-point transistor (NPN) output	AFPX-E16T
FP-X E16P	-	DC input, 8 points 8-point transistor (PNP) output	AFPX-E16P
FP-X E30T	AC	DC input, 16 points 14-point transistor (NPN) output	AFPX-E30T
FP-X E30TD	DC	16-point DC input 14-point transistor (NPN) output	AFPX-E30TD
FP-X E30P	AC	16-point DC input 14-point transistor (PNP) output	AFPX-E30P
FP-X E30PD	DC	16-point DC input Transistor (PNP) output, 14 points	AFPX-E30PD

■Further expansion and more functions achieved by using the existing FP0R expansion unit easily

The maximum number of FP0R expansion unit is up to 3 after all the control units are equipped with adaptors.

A wider range of application can be achieved by using[transistor output],[analog I/O],[thermocouple input]and[I/O LINK (network)].

Only one FP0 expansion adaptor can be installed on the control unit.

In addition, two FP-X expansion units can be installed after the adaptor is installed.



FP0 expansion adaptor (AFPX-EFPO)

Besides the supplied expansion cable of 8 cm, 30 cm and 80 cm types are also sold separately. They can be bent or straightened. (The total extension length is within 160 cm.)

Model	Specifications
AFP0RE8X	8-point DC input MIL connector
AFP0RE16X	16-point DC input MIL connector
AFP0RE8YT	8-point transistor output MIL connector
AFP0RE8YRS	8-point relay output screw terminal block
AFP0RE16YT	16-point transistor output MIL connector
AFP0RE16T	8-point DC input, 8-point transistor output, MIL connector
AFP0RE32T	16-point DC input, 16-point transistor output, MIL connector
AFP0RE8RS	4-point DC input, 4-point relay output, screw terminal block
AFP0RE16RS	8-point DC input, 8-point relay output, screw terminal block

Model	Specifications
FP0-A21	Analog 2-point input , 1-point output
FP0-A80	Analog 8-point input
FP0-A04V	Analog (voltage) 4-point output
FP0-A04I	Analog (current) 4-point output
FP0-TC4	Thermocouple 4-point input
FP0-TC8	Thermocouple 8-point input
FP0-IOL	I/O LINK unit
FP0-CCLS	CC-Link slave unit

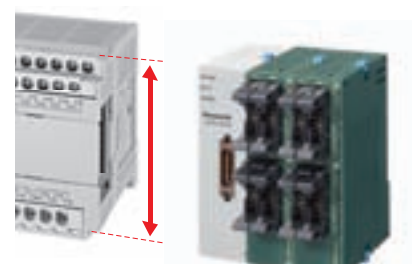

Both of them are 90 mm and can be installed in the cabinet.

Special Functions

Programmable Controller **FP-X0**

■ Pulse output function / High-speed counter function

The pulse output function of FP-X0 (1-axis for L14 and 2-axis for L30/L40/L60) is built in the body of the control unit. Compared with the previous PLC that must use the advanced or specific positioning units or more than two multi-axis control devices, FP-X0 only uses one unit basically, thus saving the space and reducing the cost.

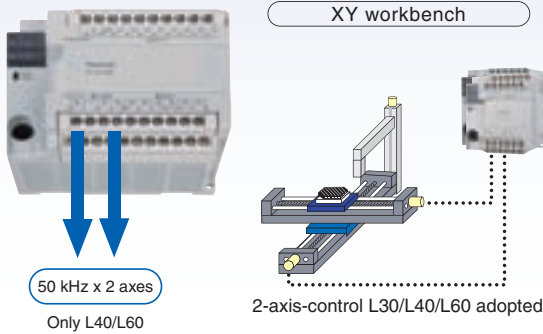

Items	Specifications
Max. frequency of pulse output	L14: 20kHz(CH0) L30: 20kHz(CH0,1) L40 L60: 50kHz(CH0,1)
Output mode	CW / CCW, Pulse/Sign output
Function	Trapezoidal control, multi-speed operation, JOG operation, original position return, 2-axis linear interpolation (Only L40 and L60)

L40 and L60 adopting 2-axis linear interpolation

2-axis linear interpolation is a kind of function that controls 2 motor axes and makes the robot arm and tool head carry out diagonal line moving simultaneously, which is applied in the stacker's picking & mounting components, the control of XY workbench and the baseplate cutting etc.

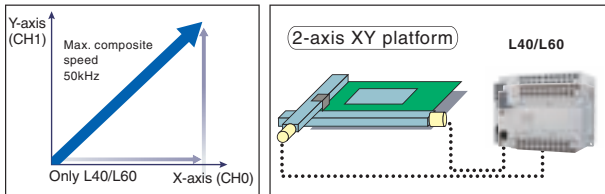

■ Body equipped with combined relay and transistor output

The load capacity of the transistor is up to 0.5 A.

Built-in 4-point high-speed counter

4-point for 1-phase or 2-point for 2-phase (X0 to X3)



Model	HSC input mode	Pulse output (1-axis)	When HSC using 1 channel	When HSC using all the channels
L14	1-phase	Stopping	20 kHz	20 kHz
		Outputting	20 kHz	20 kHz
	2-phase	Stopping	20 kHz	20 kHz
		Outputting	17 kHz	16 kHz
Model	HSC input mode	Pulse output (2-axis)	When HSC using 1 channel	When HSC using all the channels
L30	1-phase	Stopping	20 kHz	20 kHz
		Outputting	20 kHz	14 kHz
	2-phase	Stopping	20 kHz	20 kHz
		Outputting	13 kHz	12 kHz
L40/L60	1-phase	Stopping	50 kHz	33 kHz
		Outputting	36 kHz	24 kHz
	2-phase	Stopping	20 kHz	16 kHz
		Outputting	16 kHz	13 kHz

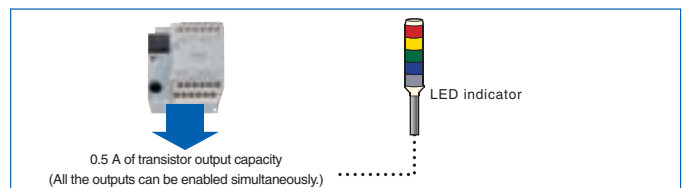

■ Built-in PID command (F356 EZPID)

One line of temperature-control program is enough.

A wider range of temperature-control applications is achieved through the use of PLC, such as the multi-section temperature control, temperature control linked with the timer, variable temperature control based on the data calculation results and multi-point temperature control etc. Using new PID commands (F356 EZPID) makes the PID control program simplified substantially than before. It was considered relatively hard to carry out temperature control through PLC before, but now it becomes quite easy. The example shown at the right side is a simple constant temperature control. If you use the F356 command together with the combination operation of touch screen, only one line of program is needed, thus making PID control amazingly simple.

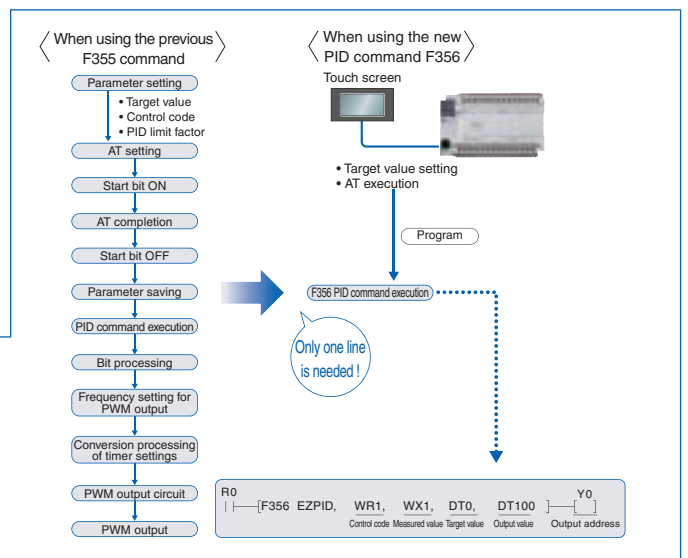
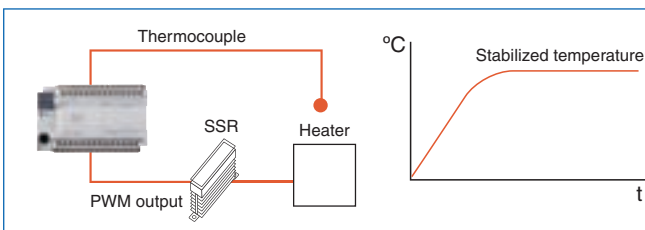

Part Number List

Programmable Controller FP-X0 Control Unit

1) Control unit

Product name	Power supply	Specifications				Part No.
		Program capacity	Analog input	RS485 communication		
FP-X0 L14R	100 to 240 V AC	24 V DC input, 8 points 0.5 A/5 to 24 V DC transistor output, 2 points 2 A relay output, 4 points	2.5 k steps	-	-	AFPX0L14R
FP-X0 L30R	100 to 240 V AC	24 V DC input, 16 points 0.5 A/5 to 24 V DC transistor output, 4 points 2 A relay output, 10 points	2.5 k steps	-	-	AFPX0L30R
FP-X0 L40R	100 to 240 V AC	24 V DC input, 24 points 0.5 A/5 to 24 V DC transistor output, 4 points 2 A relay output, 12 points	8 k steps	10 bits, 2 channel	-	AFPX0L40R
FP-X0 L40MR	100 to 240 V AC	24 V DC input, 24 points 0.5 A/5 to 24 V DC transistor output, 4 points 2 A relay output, 12 points	8 k steps	10 bits, 2 channel	Available	AFPX0L40MR
FP-X0 L60R	100 to 240 V AC	24 V DC input, 32 points 0.5 A/5 to 24 V DC transistor output, 4 points 2 A relay output, 24 points	8 k steps	10 bits, 2 channel	-	AFPX0L60R
FP-X0 L60MR	100 to 240 V AC	24 V DC input, 32 points 0.5 A/5 to 24 V DC transistor output, 4 points 2 A relay output, 24 points	8 k steps	10 bits, 2 channel	Available	AFPX0L60MR

Note) 24 V DC input: ± common

2) Expansion unit

FP-X expansion I/O unit and FP0R unit can be used.
But FP0 adaptors for FP-X expansion are required when FP0R expansion units are used.

3) Software tools (Refer to Operation Manual for the details.)

Product name	Software classification	Part No.
FPWIN GR	Japanese version with supplied cable kit	AFPS10122
	English version Full type	AFPS10520
	English version Lite type	AFPS11520
	Chinese version Full type	AFPS10820
FPWIN Pro	Korean version	AFPS10920
	Japanese version	AFPS50160
	English version	AFPS50560

Note) For FP-X0: FPWIN GR Ver.2.91 or later
FPWIN Pro Ver.6.31 or later

4) Other cables and maintenance parts

Product name	Specifications	Part No.	
Backup battery	For data storage backup and calendar/clock backup	AFP8801	
FP-X expansion cable ^{Note)}	8cm	AFPX-EC08	
	30cm	AFPX-EC30	
	80cm	AFPX-EC80	
Cable for FP and computer connection (M5 type)	3 m	Round D-SUB, 9-pin, L-shaped type	AFC8503
		Round D-SUB, 9-pin, Straight type	AFC8503S
Power cable for FP0	For the adaptor for FP0 expansion, 1 m long	AFP0581	
Installation bracket for FP0 (Long-strip type)	For FP0 expansion unit, 10 pieces per package	AFP0803	

Note) The cables for expansion can be extended to 160 cm max.

Specifications

1) Performance specifications

Items		Specifications						
		L14R	L30R	L40R	L40MR	L60R	L60MR	
Controllable I/O points	Control unit	DC input 8 points, Relay output 4 points, Transistor output 2 points	DC input 16 points, Relay output 10 points, Transistor output 4 points	DC input 24 points, Relay output 12 points, Transistor output 4 points		DC input 32 points, Relay output 24 points, Transistor output 4 points		
	When using FP-X E16 expansion I/O units	-	-	88 points max. (3 expansion units max.)		108 points max.		
	When using FP-X E30 expansion I/O units	-	-	130 points max. (3 expansion units max.)		150 points max. (3 expansion units max.)		
	When using FP0R expansion units	-	-	196 points max. (3 expansion units max.)		216 points max. (3 expansion units max.)		
Programming method/Control method		Relay symbol/Cyclic operation						
Program memory		Built-in Flash-ROM (Free of backup battery)						
Program capacity		2.5 k steps		8 k steps				
No of instruction	Basic commands	Approx. 114 kinds						
	High-level commands	Approx. 230 kinds						
Processing speed		0.08 μs/step for basic commands		3 k steps: 0.08 μs/step for basic commands, 0.32 μs for high-level commands(MV commands)				
		0.32 μs for high-level commands (MV commands)		After 3 k steps: 0.58 μs/step for basic commands, 1.62 μs for high-level commands(MV commands)				
I/O refreshing + basic time	Basic time	0.15 ms or less	0.18 ms or less	0.31 to 0.35 ms or less		0.34 to 0.39 ms or less		
		When using E16: 0.4 ms × No. of units When using E30: 0.5 ms × No. of units When using FP0 expansion adaptors: 1.4 ms + the refreshing time of the FP0 expansion unit						
Memory for processing	Relays	External input (X) ^{Note 1)}	960 points		1760 points			
		External output (Y) ^{Note 1)}	960 points		1760 points			
		Internal relay (R)	1008 points		4096 points			
		Special internal relay (R)	224 points					
		Timer-Counter (T/C)	256 points ^{Note 2)}		1024 points ^{Note 2)}			
	Memory area	Link relay (L)	No		2048 points			
		Data register (DT)	2500 words		8192 words			
		Special data register (DT)	420 words					
		Link data register (LD)	No		256 words			
		File registration (FL)	No					
Index register (I)	14 words (IO to ID)							
Differential points	Equivalent to program capacity							
Master control relay (MCR)	32 points		256 points					
Label number (JP+LOOP)	100 points		256 points					
No. of step programs	128 (Engineering)		1000 (Engineering)					
No. of subroutines	100		500					
No. of interrupt programs	Input: 8 programs, timing: 1 program							
Sampling trace	No		Yes					
Comments storage	All of the I/O comments, explanations and block comments can be saved. (Free of backup battery, 328 k bytes)							
PLC link function	No		Yes					
Constant scan	In unit of 0.5 ms: 0.5 ms to 600 ms							
Password	Available (4 or 8 digits)							
Upload protection	Available							
Self-diagnosis function	Checks of the watchdog timer and the program syntax							

Items		Specifications					
		L14R	L30R	L40R	L40MR	L60R	L60MR
Program editing during Run		Available (Capacity modified simultaneously: 128 steps) But comments cannot be modified during the process.		Available (Capacity modified simultaneously: 512 steps) But comments can be modified during the process.			
Downloading during Run		Available					
High-speed counter ^{Note 3)} ^{Note 4)}	Body input	1-phase, 4-channel (20 kHz max.) and 2-phase, 2-channel (20 kHz max.)		1-phase, 4-channel (50 kHz max.) and 2-phase, 2-channel (20 kHz max.)			
	Body output	Pulse: 1-channel (20 kHz max.) PWM: 1-channel (1.6 kHz max.)	Pulse: 2-channel (20 kHz max.) PWM: 2-channel (1.6 kHz max.)	Pulse: 2-channel (50 kHz) PWM: 2-channel (3.0 kHz max.)			
Pulse catch input/Interrupt program		8 points (High-speed counting and interrupt input included)					
Periodical interrupt		0.5 ms unit: 0.5 ms to 1.5 s, 10 ms unit: 10 ms to 30 s					
Analog input		No		2-channel (For inputting any of the following items in each channel) Potentiometer input Min. resistance value of potentiometer: 5 kΩ 10-bit resolution (K0 to K1000) Accuracy ± 1.0% F.S.+ accuracy of external resistors Thermistor input For inputting the resistance value of the thermistor (Min. resistance value of external thermistors + external resistance value > 2 kΩ) 10-bit resolution (K0 to K1023) Accuracy ± 1.0% F.S.+ accuracy of external thermistors Voltage input Absolute max. input voltage: 10 V 10-bit resolution (K0 to K1023) Accuracy ± 2.5% F.S. (F.S. = 10 V)			
Calendar/clock		No		Yes			
Flash ROM backup ^{Note 5)}	Backup made according to commands of F12 and P13	Data memory (2500 words)		Data memory (8192 words)			
	Automatic backup when power OFF	Counter: 6 points (C250 to C255) Process value of the counter: 6 points (EV250 to EV255) Internal relays: 5 points (WR58 to WR62) Data memory: 300 words (DT2200 to DT2499)		Counter: 16 points (C1008 to C1023) Process value of the counter: 16 points (EV1008 to EV1023) Internal relays: 8 points (WR248 to WR255) Data memory: 302 words (DT7890 to DT8191)			
Backup battery		No		Yes (Backup lasting for the whole process)			
RS485 communication port		No		Yes		No	

Note 1) The actual usable points depend on the combination of the hardware.

Note 2) The points of the timer can be added as required.

Note 3) The rated voltage is 24 V DC at 25 °C. The frequency may fall according to the changes of the voltage, temperature and operating conditions.

Note 4) The maximum frequency may vary with the difference of the operating method.

Note 5) The allowable writing operation is within 10000 times. Areas to be held and not held can be specified using the system registers.

2) General specifications

Items	Specifications	
Operating temperature	0 to +55°C	
Storage temperature	-40 to +70°C	
Operating humidity	10 to 95% RH (at 25 °C, no condensation)	
Storage humidity	10 to 95% RH (at 25 °C, no condensation)	
Withstand voltage <small>Note 1) Note 2)</small>	Input terminals ⇔ Relay output terminals	2300 V AC, 1 minute
	All of the transistor output terminals ⇔ All of the relay output terminals	
	All of the input terminals⇔ All of the power supply terminals and functional ground terminals	
	All of the relay output terminals ⇔ All of the power supply terminals and functional ground terminals	
	All of the transistor output terminals ⇔ All of the power supply terminals and functional ground terminals	
Insulation resistance <small>Note 1)</small>	Power supply terminals ⇔ Ground terminals	1500 V AC, 1 minute
	Input terminals ⇔ Transistor output terminals	500 V AC, 1 minute
	Input terminals ⇔ Output terminals	100 MΩ min. (500 V DC insulation resistance meter)
All of the transistor output terminals ⇔ All of the relay output terminals		
All of the input terminals ⇔ All of the power supply terminals and functional ground terminals		
All of the output terminals ⇔ All of the power supply terminals and functional ground terminals		
Vibration resistance	5 to 8.4 Hz, 3.5 mm amplitude in one direction, 1 scan/1 minute 8.4 to 150 Hz, fixed acceleration of 9.8 m/s ² , 1 scan/1 minute 10 minutes in X,Y,Z direction each	
	Shock resistance	
Noise immunity	1500 V [p-p] pulse width 50 ns, 1 μs (Measured from noise simulation method AC power supply terminals)	
Operating environment	No corrosive gases or too much dust	
Conformed EC Directives	EMC Directive: EN61131-2, Low Voltage Directive: EN61131-2	
Overvoltage class	II	
Pollution level	2	
Weight	L14R: approx. 280g L30R: approx. 450g L40R/L40MR: approx. 530g L60R/L60MR: approx. 730g	

Note 1) The programmable port, RS485 communication port and the internal digital circuit part are non-insulation type.

Note 2) The cut-off current is 5 mA (The default value when shipped from the factory).

5) Output specifications

Relay output specifications

Items	Specifications					
	L14R	L30R	L40R	L40MR	L60R	L60MR
Insulation method	Relay insulation					
Output form	1a output (Relay replacement disabled)					
Rated control capacity (Resistance load) <small>Note)</small>	2A 250 V AC, 2A 30 V DC (per point)					
Output points per common	1 point/ COM×2 2 points/ COM×1	2 points/ COM×1 4 points/ COM×2	1 point/COM×2 2 points/COM×1 4 points/COM×2		4 points/COM×6	
Response time	OFF→ON	Approx. 10 ms				
	ON→OFF	Approx. 8 ms				
Life	Mechanical	20000000 times min. (Switching frequency 180 times/minute)				
	Electrical	100000 times min. (Depending on the rated control capacity, switching frequency of 20 times/minute)				
Surge absorber	No					
Action indicator	LED indication					

Note) There are restrictions on the rated current for each output block. Each usable rated current is as below.

L14:Y2 to Y5(4 points) Max. 6A in total

L30:Y4 to YD(10 points) Max. 8A in total

L40:Y4 to YFD(12 points) Max. 8A in total

L60:Y4 to YB(8 points) Max. 8A in total, YC to Y1B(16 points) Max. 8A in total

Circuit diagram

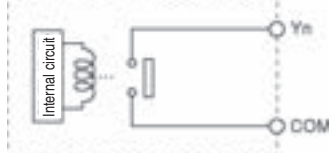

3) Power supply specifications

AC power supply

Items	Specifications	
	L14R	L30R,L40R,L40MR,L60R,L60MR
Rated voltage	100 to 240 V AC	
Applied voltage range	85 to 264 V AC	
Inrush current	35A max.(at 240 V AC and 25°C)	40A max.(at 240 V AC and 25°C)
Momentary power off time	10 ms (when 100 V AC used)	
Frequency	50/60 Hz(47 to 63 Hz)	
Leakage current	0.75 mA max.between the input and protective ground terminals	
Service life of built-in power supply	20000 h (at 55°C)	
Fuse	Built-in (replacement disabled)	
Insulation system	Transformer isolation	
Screw of terminal block	M3	

Universal power supply for input (output) (L30/L40/L60 only)

Items	Specifications
Rated output voltage	24 V DC
Applied voltage range	21.6 to 26.4 V DC
Rated output current	0.3A
Overcurrent protection <small>Note)</small>	Yes
Screw of terminal block	M3

Note) Output short protection is a temporary overcurrent protection. When the short is detected, all the power supplies of PLC will be turned OFF.
If the current load out of this specification is connected and in consecutive over-loaded status, failures may occur.

4) Input specifications

Items	Specifications					
	L14R	L30R	L40R	L40MR	L60R	L60MR
Insulation method	Optical coupler					
Rated input voltage	24 V DC					
Applied voltage range	21.6 V DC to 26.4 V DC					
Rated input current	Approx. 3.5 mA (Control unit: X0 to X3); Approx. 4.3 mA (Control unit: X4 and the following ones)					
Input points per common	8 points/COM (L14R), 16 points/COM (L30R), 24 points/COM (L40R), 16 points/COM×2 (L60R) (Input power supply +/- are both available.)					
Min. ON voltage/Min. ON current	19.2 V DC/3 mA					
Max. OFF voltage/Max. OFF current	2.4 V DC/1.0 mA					
Input impedance	Approx. 6.8 kΩ (Control units: X0 to X3); Approx. 5.6 kΩ (control unit X4 and the following ones)					
Response time	OFF→ON	For X0 to X3, 1 ms max.: common input 25 μs max. <small>Note)</small> : When setting high-speed counter, pulse catching input and interrupt input		For X0 to X3, 1 ms max.: common input 10 μs max. <small>Note)</small> : When setting high-speed counter, pulse catching input and interrupt input		
		X4 and the following ones: 1 ms max.		X4 and the following ones: 1 ms max.		
Response time	ON→OFF	Same as the above.				
	Action indicator					
LED indication						
EN61131-2 application type TYPE 3 standard (Depending on the above-mentioned specifications)						

Note) The specifications mentioned above are at rated 24 V DC and operating temperature of 25°C.

Circuit diagram

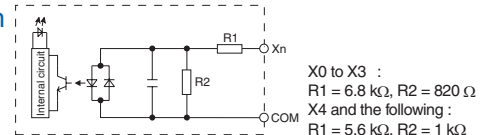

Transistor (NPN) output specifications

Items	Specifications					
	L14R	L30R	L40R	L40MR	L60R	L60MR
Insulation method	Optical coupler					
Output method	Open-collector					
Rated load voltage	5 to 24 V DC					
Allowable range of load voltage	4.75 to 26.4 V DC					
Max.load current	0.5 A					
Max.impact current	1.5 A					
Output points per common	2 points/COM	4 points/COM				
Leakage current at OFF status	1 μA max.					
Max. voltage drop at ON status	0.3 V DC max.					
Response time (at 25°C)	OFF→ON	10 μs max. (Load current over 15 mA)		5 μs max. (Load current over 15 mA)		
		40 μs max. (Load current over 15 mA)		15 μs max. (Load current over 15 mA)		
External power supply (Positive and negative terminals)	Voltage	21.6 to 26.4 V DC				
	Current	15 mA max.				
Surge absorber	Zener diode					
Action indicator	LED indication					

Circuit diagram

[NPN output]
[Y0 to Y3]

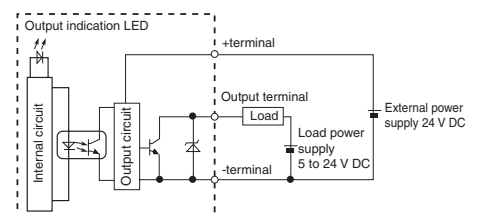

■ Dimensions of FP-X0 programmable controller (Unit: mm in)

● AFPX0L14R

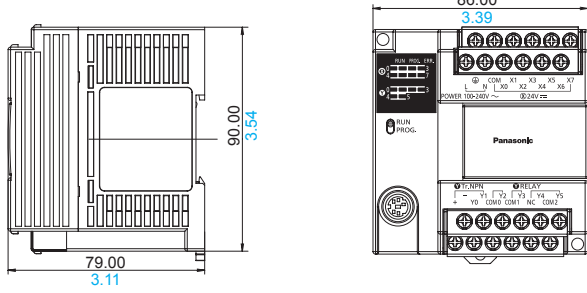

● AFPX0L30R

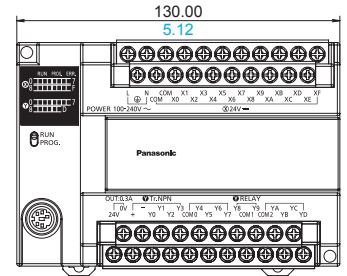
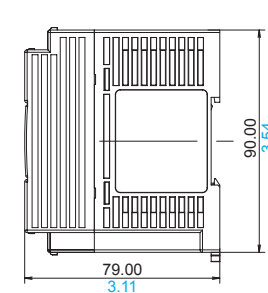

● AFPX0L40R AFPX0L40MR

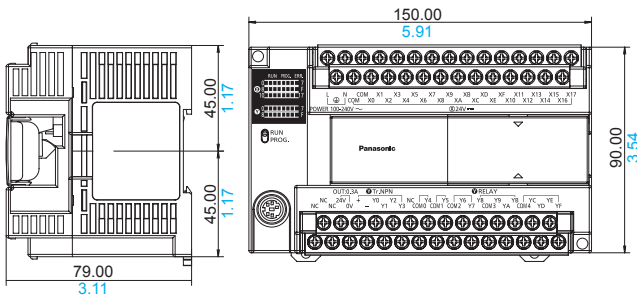

● AFPX0L60R AFPX0L60MR

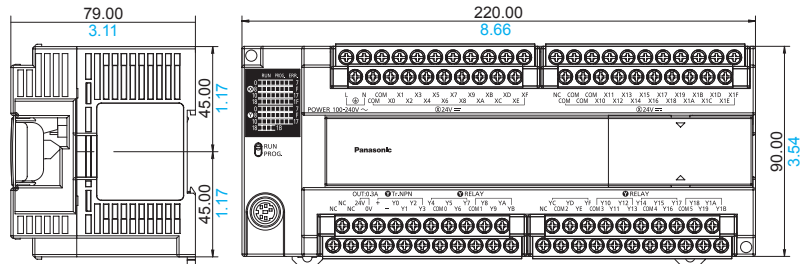

● Installation dimensions

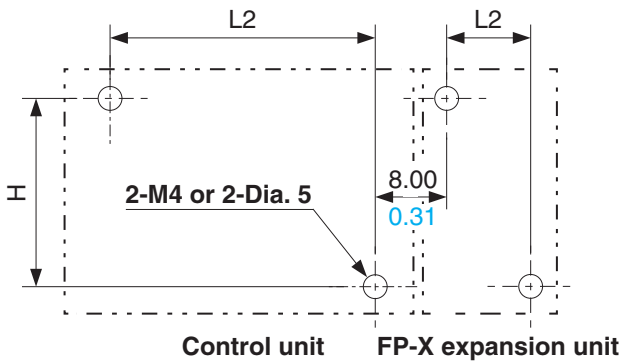

(Unit: mm in)

Item	Model	L2	H
FP-X0 control unit	L14R	78.00 3.07	82.00 3.22
	L30R	122.00 4.80	
	L40R , L40MR	142.00 5.59	
	L60R , L60MR	212.00 8.35	
FP-X expansion unit	E14 , E16	52.00 2.05	
	E30	92.00 3.62	

(Tolerance: ± 0.5)

Please contact.....

Panasonic Electric Works SUNX Suzhou Co.,Ltd.

■No.97.Huoju Road, New District Suzhou, Jiangsu province, China P.R.215009
 ■Telephone: +86-512-6843-2580 ■Facsimile: +86-512-6843-2590

