



Chipsmall Limited consists of a professional team with an average of over 10 year of expertise in the distribution of electronic components. Based in Hongkong, we have already established firm and mutual-benefit business relationships with customers from,Europe,America and south Asia,supplying obsolete and hard-to-find components to meet their specific needs.

With the principle of “Quality Parts,Customers Priority,Honest Operation,and Considerate Service”,our business mainly focus on the distribution of electronic components. Line cards we deal with include Microchip,ALPS,ROHM,Xilinx,Pulse,ON,Everlight and Freescale. Main products comprise IC,Modules,Potentiometer,IC Socket,Relay,Connector.Our parts cover such applications as commercial,industrial, and automotives areas.

We are looking forward to setting up business relationship with you and hope to provide you with the best service and solution. Let us make a better world for our industry!



Contact us

Tel: +86-755-8981 8866 Fax: +86-755-8427 6832

Email & Skype: info@chipsmall.com Web: www.chipsmall.com

Address: A1208, Overseas Decoration Building, #122 Zhenhua RD., Futian, Shenzhen, China



Surface Mount 2017.50MHz SAW Filter

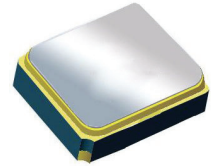

1.4 x 1.1 x 0.7 mm

AFS14A15-2017.50-T3

Moisture Sensitivity Level (MSL) – This product is Hermetically Sealed and not Moisture Sensitive - MSL = N/A: Not Applicable



**RoHS
Compliant**

FEATURES:

- 1.4 x 1.1 x 0.7 mm low profile SMT package
- Low Insertion loss
- Excellent selectivity with high out-of-band rejection

APPLICATIONS:

- Wireless Communication
- Remote Control
- Cellular Phones

ELECTRICAL SPECIFICATIONS:

Maximum Ratings

Item	Value
Input Power Level	+13 dBm max.
DC Permissive Voltage	3.0V DC max.
Operating Temperature Range	-30°C to + 85°C
Storage Temperature Range	-40°C to + 85°C

Parameters	Minimum	Typical	Maximum	Units	Notes
Center Frequency (f_c)		2017.50		MHz	
Insertion Loss (IL)		2.0	2.8	dB	(2010.00~2025.00MHz)
Effective Bandwidth		15		MHz	
Amplitude Ripple		0.25	1.00	dB	(2010.00~2025.00MHz)
Worst-Case Input / Output Return Loss		20.8	10.88	dB	(2010.00~2025.00MHz)
Stop-band Attenuation (Referenced to 0.0 dB)	41	45		dB	DC~1850 MHz
	34	36			1850~1950 MHz
	15	19			1950~1980 MHz
	6	13			2050~2075 MHz
	23	37			2075~2110 MHz
	37	40			2110~3500 MHz
	34	40			3500~4060 MHz
	29	37			4060~5000 MHz
	25	35			5000~5500 MHz
	23	33			5500~6000 MHz
Terminating Source Impedance (Z_S)		50		Ω	
Temperature Coefficient of Frequency		-36		ppm/°C	

TEST CIRCUIT:

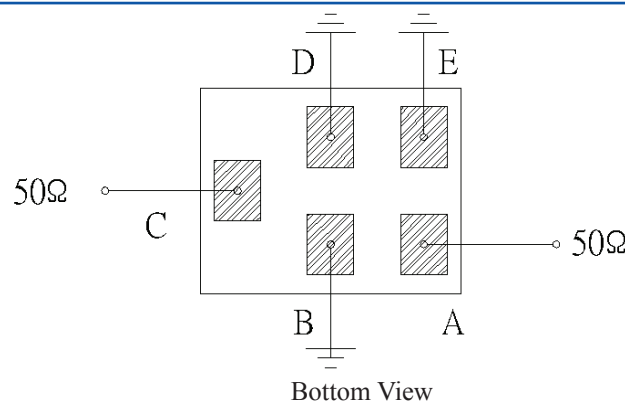

Surface Mount 2017.50MHz SAW Filter

AFS14A15-2017.50-T3



RoHS
Compliant

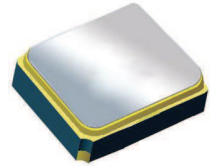

1.4 x 1.1 x 0.7 mm

OUTLINE DIMENSIONS:

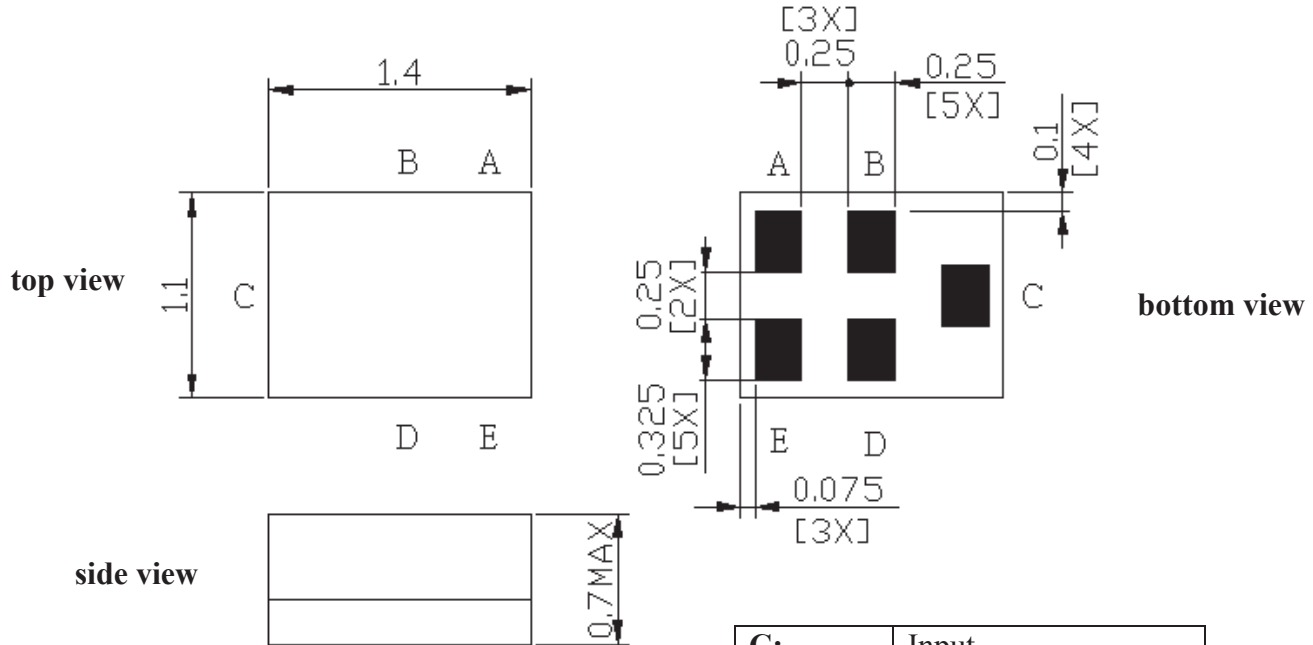

C:	Input
A:	Output
B, D, E:	Ground

*All Dimensions are in mm

Recommended Land Pattern:

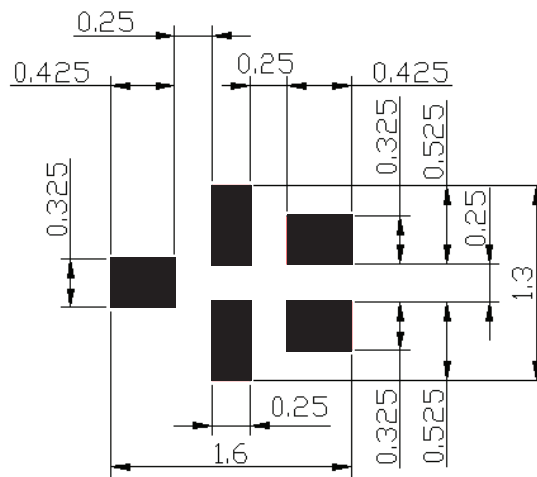

■ : Land Pattern
Unit : mm

Surface Mount 2017.50MHz SAW Filter

AFS14A15-2017.50-T3



RoHS
Compliant

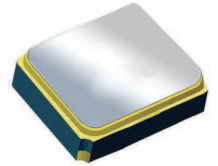

1.4 x 1.1 x 0.7 mm

FREQUENCY CHARACTERISTICS:

Filter Frequency Response (Narrowband)

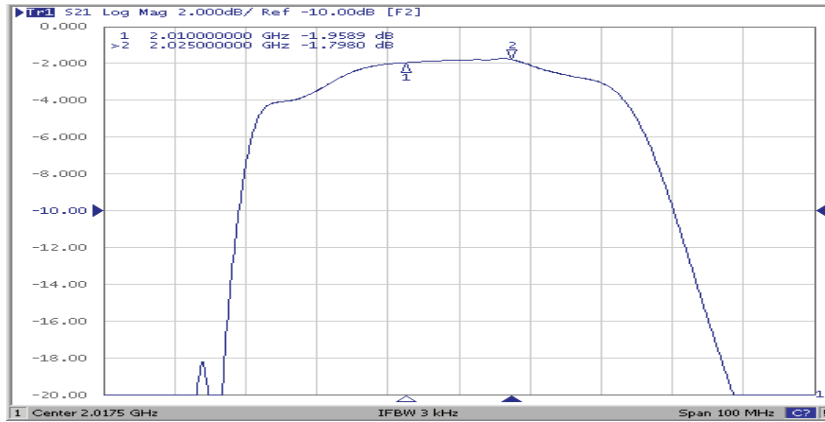

Filter Frequency Response (Wideband)

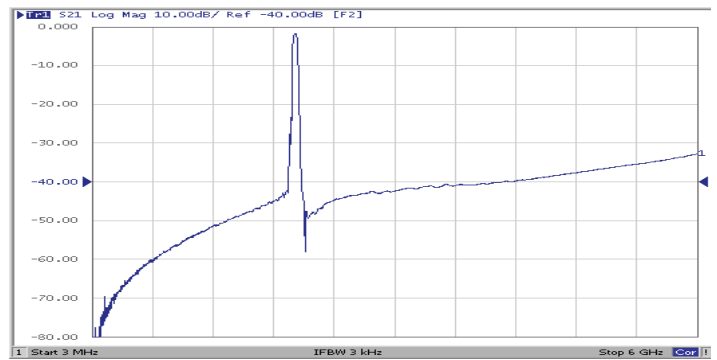
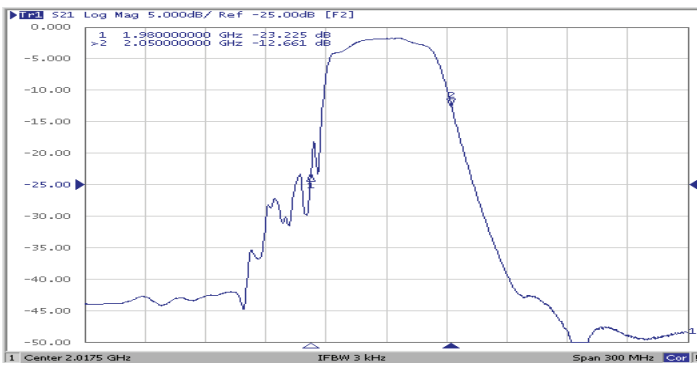

REFLECTION FUNCTIONS:

S11

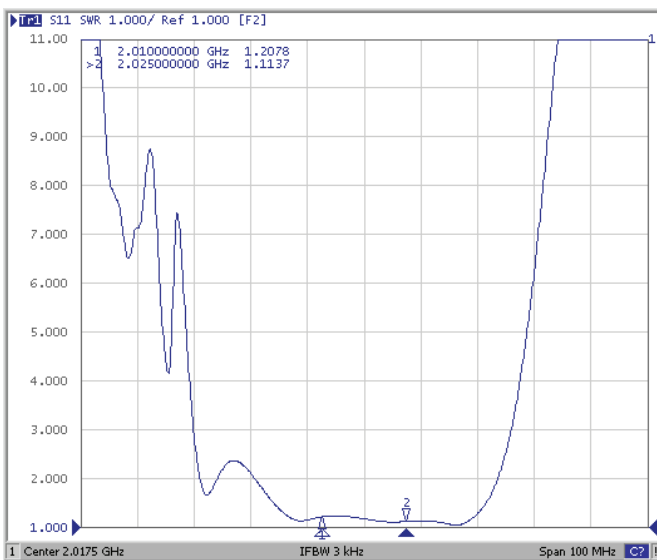

S22

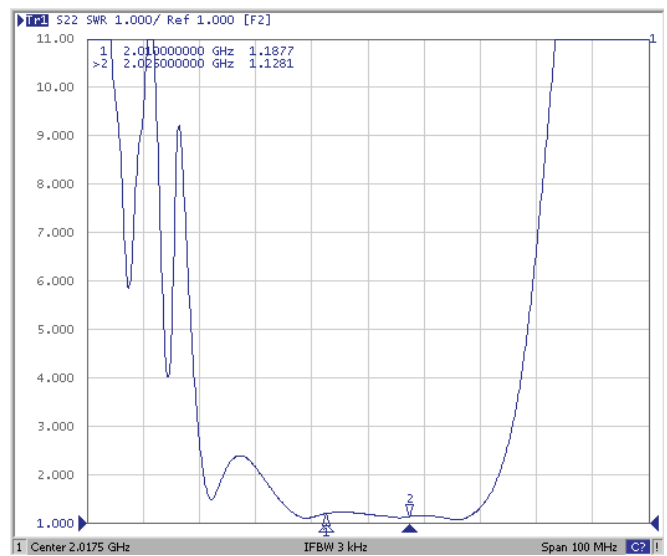

Surface Mount 2017.50MHz SAW Filter

AFS14A15-2017.50-T3



RoHS
Compliant

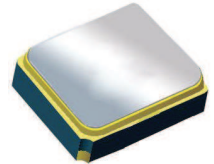

1.4 x 1.1 x 0.7 mm

REFLOW PROFILE:

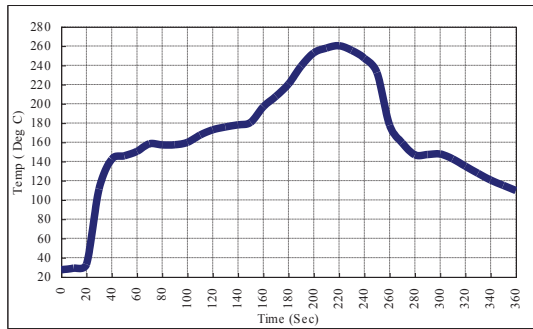

PACKAGING: 3000 Units/Reel “-T2” parts (2k/reel) are no longer available effective 01/01/2013

Reel Count : 7" = 3k units

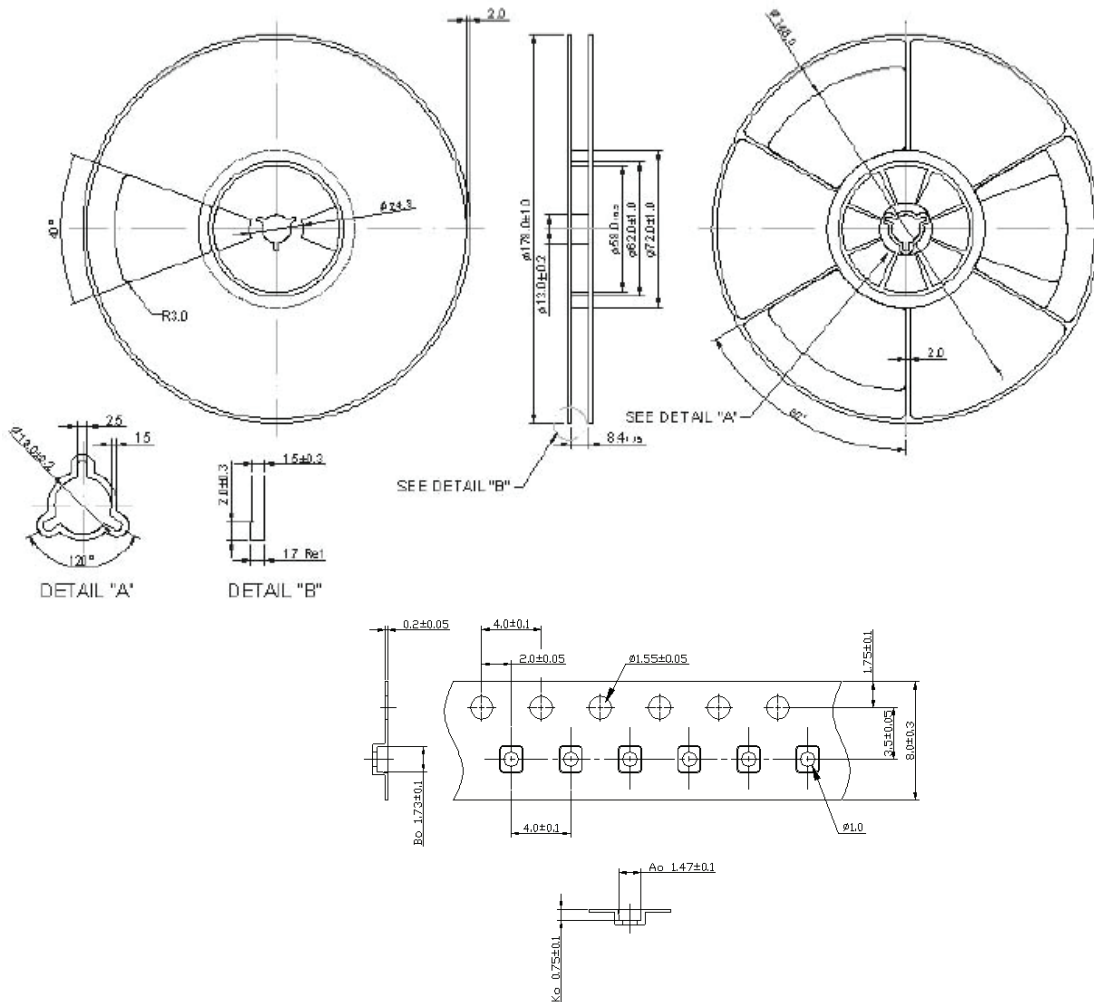

ATTENTION: Abracon Corporation's products are COTS – Commercial-Off-The-Shelf products; suitable for Commercial, Industrial and, where designated, Automotive Applications. Abracon's products are not specifically designed for Military, Aviation, Aerospace, Life-dependant Medical applications or any application requiring high reliability where component failure could result in loss of life and/or property. For applications requiring high reliability and/or presenting an extreme operating environment, written consent and authorization from Abracon Corporation is required. Please contact Abracon Corporation for more information.

ABRACON IS
ISO 9001:2008
CERTIFIED



Visit www.abracon.com for Terms & Conditions of Sale
30332 Esperanza, Rancho Santa Margarita, California 92688
tel 949-546-8000 | fax 949-546-8001 | www.abracon.com

Revised: 04.16.13