



Chipsmall Limited consists of a professional team with an average of over 10 year of expertise in the distribution of electronic components. Based in Hongkong, we have already established firm and mutual-benefit business relationships with customers from,Europe,America and south Asia,supplying obsolete and hard-to-find components to meet their specific needs.

With the principle of “Quality Parts,Customers Priority,Honest Operation,and Considerate Service”,our business mainly focus on the distribution of electronic components. Line cards we deal with include Microchip,ALPS,ROHM,Xilinx,Pulse,ON,Everlight and Freescale. Main products comprise IC,Modules,Potentiometer,IC Socket,Relay,Connector.Our parts cover such applications as commercial,industrial, and automotives areas.

We are looking forward to setting up business relationship with you and hope to provide you with the best service and solution. Let us make a better world for our industry!



## Contact us

Tel: +86-755-8981 8866 Fax: +86-755-8427 6832

Email & Skype: info@chipsmall.com Web: www.chipsmall.com

Address: A1208, Overseas Decoration Building, #122 Zhenhua RD., Futian, Shenzhen, China



# Surface Mount 2185.00MHz SAW Filter

AFS14A30-2185.00-T2



**RoHS**  
Compliant

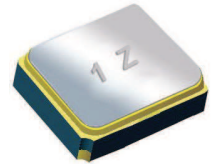

1.4 x 1.1 x 0.7 mm

## FEATURES:

- 1.4 x 1.1 x 0.7 mm low profile SMT package
- Low Insertion loss
- Excellent selectivity with high out-of-band rejection

## APPLICATIONS:

- Wireless Communication
- Remote Control
- Cellular Phones

## ELECTRICAL SPECIFICATIONS:

### Maximum Ratings

Item	Value
Input Power Level	+10 dBm max.
DC Permissive Voltage	3.0V DC max.
Operating Temperature Range	-30°C to + 105°C
Storage Temperature Range	-40°C to + 105°C

Parameters	Minimum	Typical	Maximum	Units	Notes
Center Frequency ( $f_c$ )		2185		MHz	
Insertion Loss (IL)		2.0	3.50	dB	(2170.00~2200.00MHz)
3-dB Bandwidth		30.00		MHz	
Amplitude Ripple		0.50	2.30	dB	(2170.00~2200.00MHz)
Worst-Case Input / Output Return Loss		12.73	10.88	dB	(2170.00~2200.00MHz)
Stop-band Attenuation (Referenced to 0.0 dB)	29	30.5		dB	DC~1980 MHz
	32	39.4			1980~2010 MHz
	20	32			2010~2110 MHz
	20	27			2260~2300 MHz
	29	34			2300~3500 MHz
	20	23			3500~6000 MHz
Terminating Source Impedance ( $Z_S$ )		50		$\Omega$	
Temperature Coefficient of Frequency		-36		ppm/°C	

## TEST CIRCUIT:

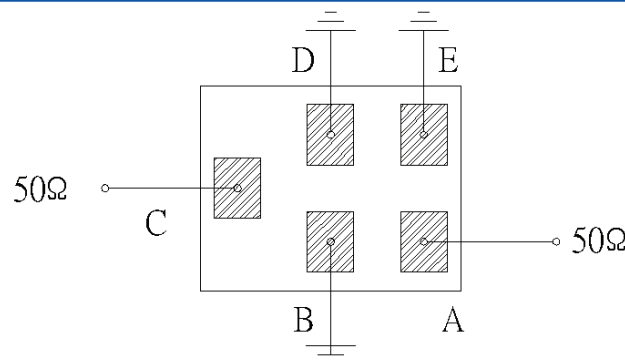

# Surface Mount 2185.00MHz SAW Filter

AFS14A30-2185.00-T2



RoHS  
Compliant

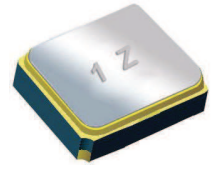

1.4 x 1.1 x 0.7 mm

## OUTLINE DIMENSIONS:

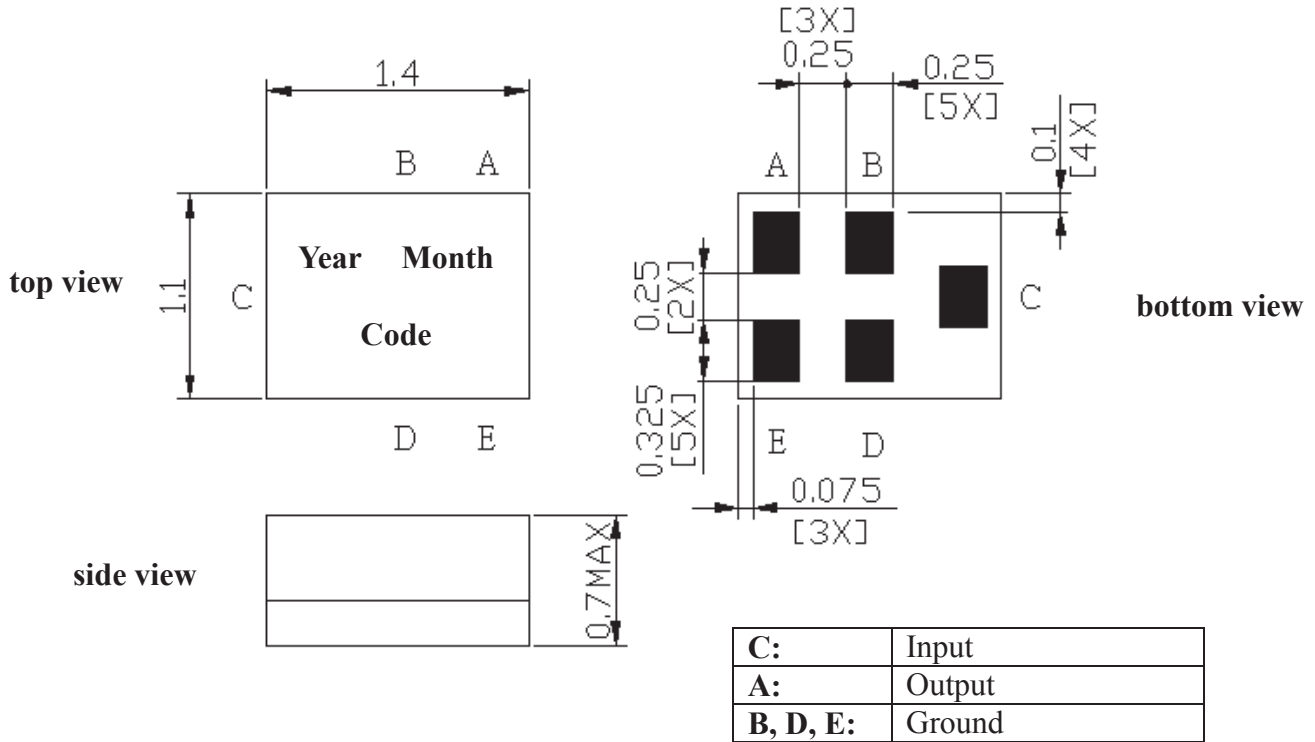

\*All Dimensions are in mm

## Recommended Land Pattern:

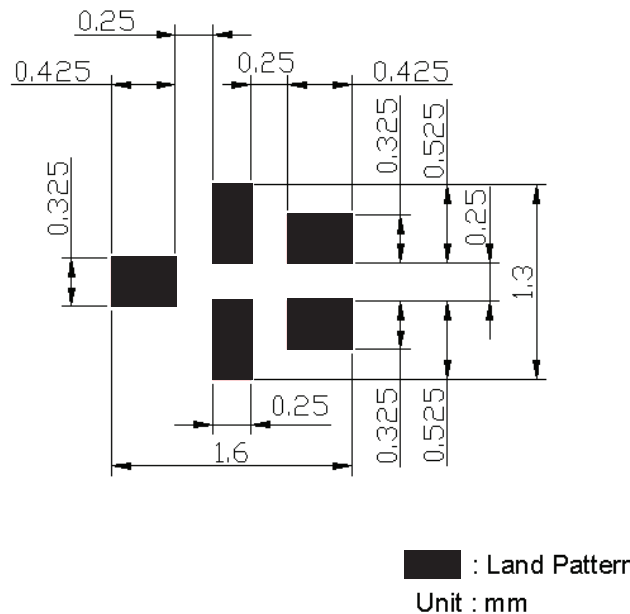

# Surface Mount 2185.00MHz SAW Filter

AFS14A30-2185.00-T2



RoHS  
Compliant

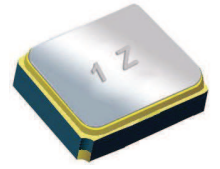

1.4 x 1.1 x 0.7 mm

## FREQUENCY CHARACTERISTICS:

### Filter Frequency Response (Narrowband)

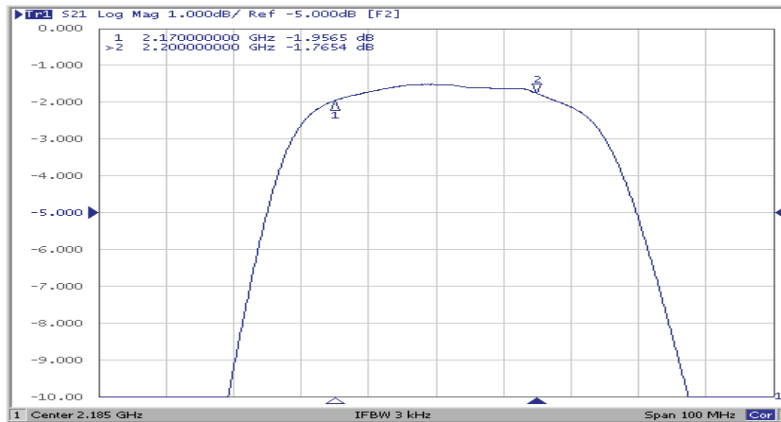

### Filter Frequency Response (Wideband)

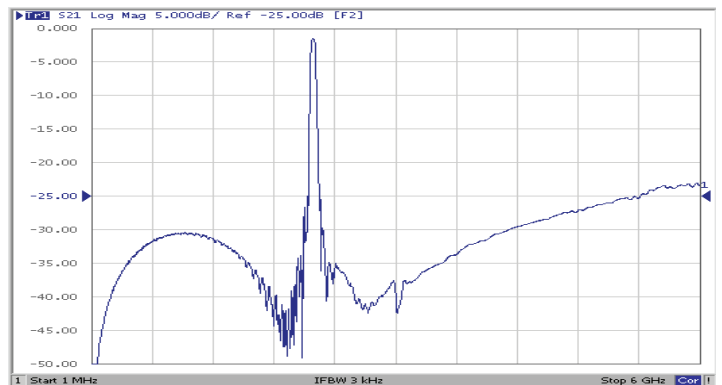
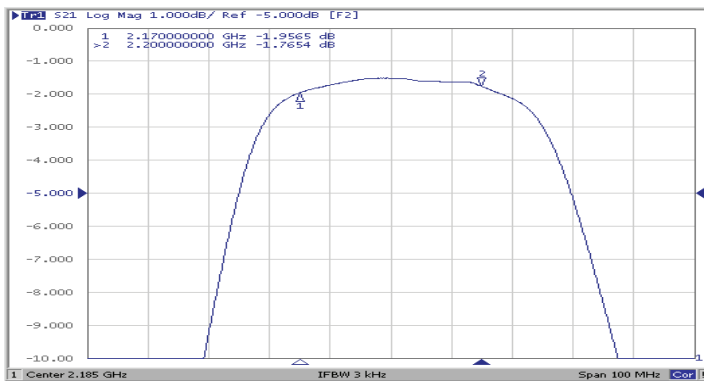

## REFLECTION FUNCTIONS:

### S11

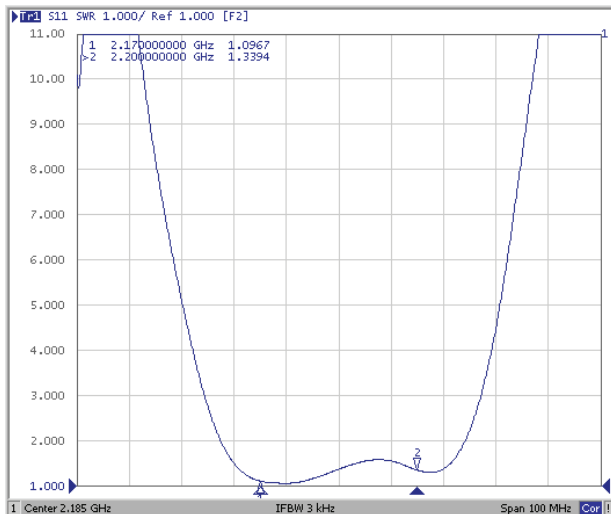

### S22

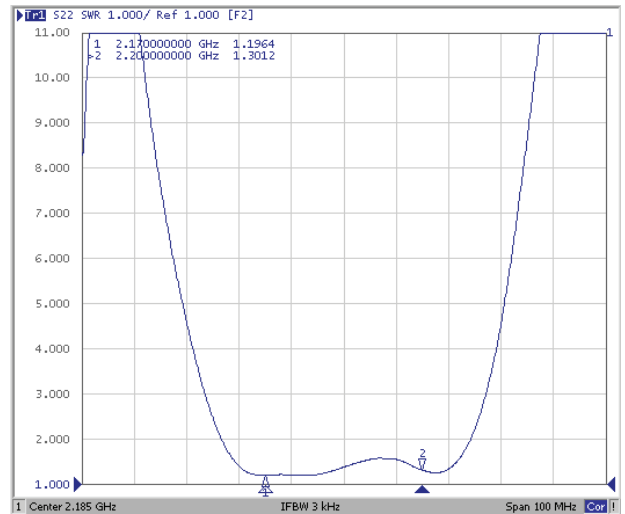

ABRACON IS  
ISO 9001:2008  
CERTIFIED



Visit [www.abracon.com](http://www.abracon.com) for Terms & Conditions of Sale  
30332 Esperanza, Rancho Santa Margarita, California 92688  
tel 949-546-8000 | fax 949-546-8001 | [www.abracon.com](http://www.abracon.com)

Revised: 07.23.12

# Surface Mount 2185.00MHz SAW Filter

AFS14A30-2185.00-T2



RoHS  
Compliant

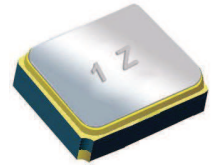

1.4 x 1.1 x 0.7 mm

## REFLOW PROFILE:

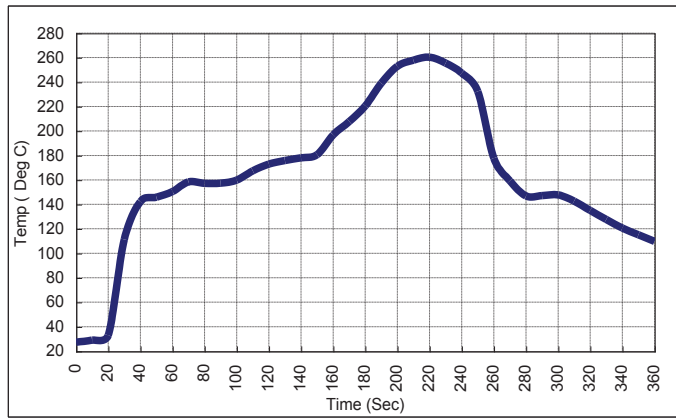

## PACKAGING: 2000 Units/Reel

Reel Count : 7" = 2k units

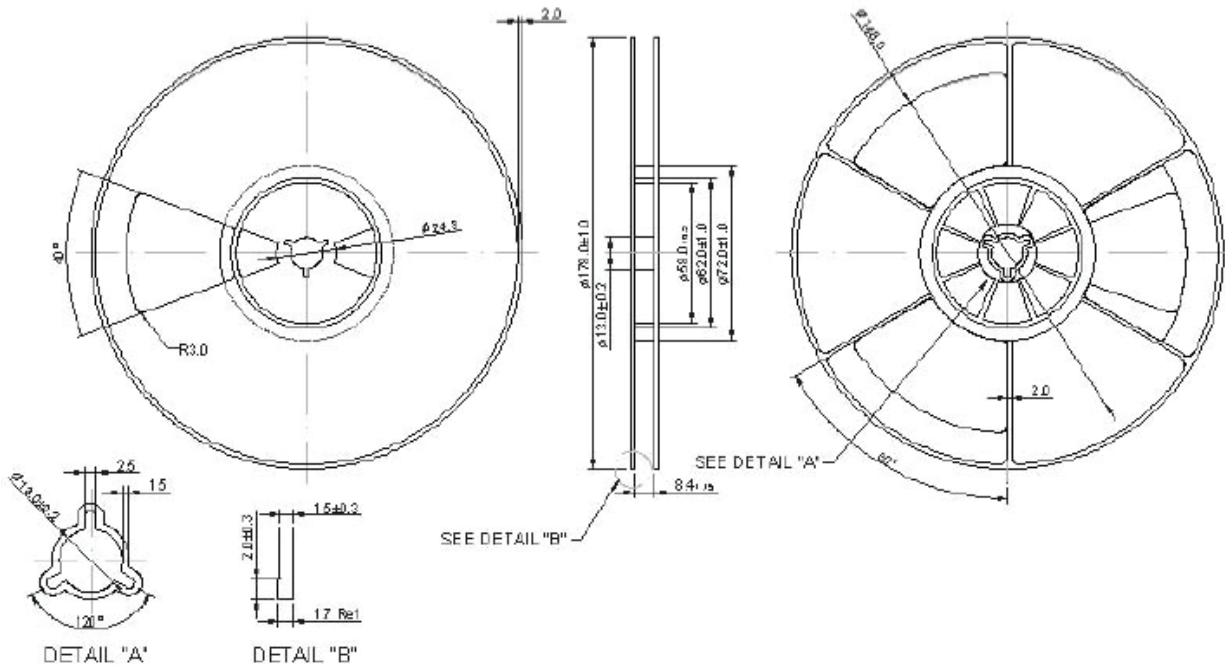

**ATTENTION:** Abracon Corporation's products are COTS – Commercial-Off-The-Shelf products; suitable for Commercial, Industrial and, where designated, Automotive Applications. Abracon's products are not specifically designed for Military, Aviation, Aerospace, Life-dependant Medical applications or any application requiring high reliability where component failure could result in loss of life and/or property. For applications requiring high reliability and/or presenting an extreme operating environment, written consent and authorization from Abracon Corporation is required. Please contact Abracon Corporation for more information.

ABRACON IS  
ISO 9001:2008  
CERTIFIED



Visit [www.abracon.com](http://www.abracon.com) for Terms & Conditions of Sale  
30332 Esperanza, Rancho Santa Margarita, California 92688  
tel 949-546-8000 | fax 949-546-8001 | [www.abracon.com](http://www.abracon.com)

Revised: 07.23.12