



Chipsmall Limited consists of a professional team with an average of over 10 year of expertise in the distribution of electronic components. Based in Hongkong, we have already established firm and mutual-benefit business relationships with customers from,Europe,America and south Asia,supplying obsolete and hard-to-find components to meet their specific needs.

With the principle of "Quality Parts,Customers Priority,Honest Operation,and Considerate Service",our business mainly focus on the distribution of electronic components. Line cards we deal with include Microchip,ALPS,ROHM,Xilinx,Pulse,ON,Everlight and Freescale. Main products comprise IC,Modules,Potentiometer,IC Socket,Relay,Connector.Our parts cover such applications as commercial,industrial, and automotives areas.

We are looking forward to setting up business relationship with you and hope to provide you with the best service and solution. Let us make a better world for our industry!



Contact us

Tel: +86-755-8981 8866 Fax: +86-755-8427 6832

Email & Skype: info@chipsmall.com Web: www.chipsmall.com

Address: A1208, Overseas Decoration Building, #122 Zhenhua RD., Futian, Shenzhen, China



Surface Mount 2436.00MHz SAW Filter

AFS14A72-2436.00-T2



RoHS
Compliant

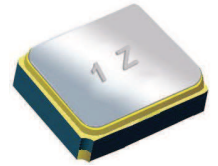

1.4 x 1.1 x 0.7 mm

FEATURES:

- 1.4 x 1.1 x 0.7 mm low profile SMT package
- Low Insertion loss
- Excellent selectivity with high out-of-band rejection

APPLICATIONS:

- Wireless Communication
- Remote Control
- Cellular Phones

ELECTRICAL SPECIFICATIONS:

Maximum Ratings

Item	Value
Input Power Level	+10 dBm max.
DC Permissive Voltage	3.0V DC max.
Operating Temperature Range	-30°C to + 85°C
Storage Temperature Range	-40°C to + 85°C

Parameters	Minimum	Typical	Maximum	Units	Notes
Center Frequency (f_c)		2436.00		MHz	
Insertion Loss (IL)		3.5	4.4	dB	(2400.00~2472.00MHz)
3-dB Bandwidth		72		MHz	
Amplitude Ripple		2.0	3.3	dB	(2400.00~2472.00MHz)
Worst-Case Input / Output Return Loss		9.54	7.35	dB	
Stop-band Attenuation (Referenced to 0.0 dB)	25	35		dB	DC~960 MHz
	25	33			960~1580 MHz
	25	34			1710~1990 MHz
	28	37			2110~2170 MHz
	30	40			2496~2690MHz @ 25°C
	10	20			2496~2690MHz over the operating temperature
	25	44			2690~4800MHz
	20	36			4800~5000MHz
	15	31			5000~6000MHz
Terminating Source Impedance (Z_s)		50		Ω	
Temperature Coefficient of Frequency		-36		ppm/°C	

TEST CIRCUIT:

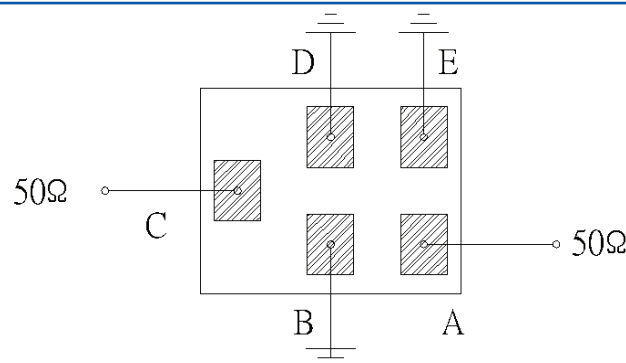

Surface Mount 2436.00MHz SAW Filter

AFS14A72-2436.00-T2



RoHS
Compliant

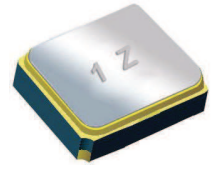

1.4 x 1.1 x 0.7 mm

OUTLINE DIMENSIONS:

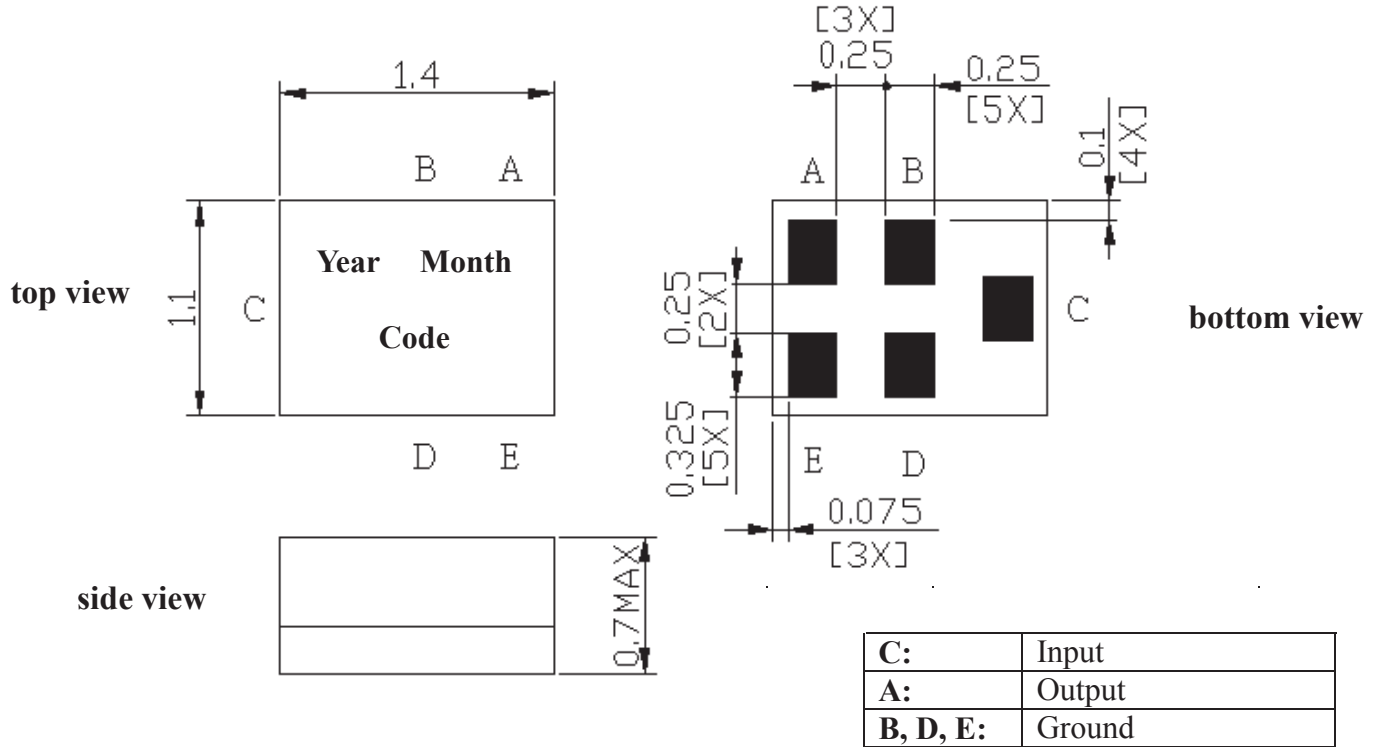

*All Dimensions are in mm

Recommended Land Pattern:

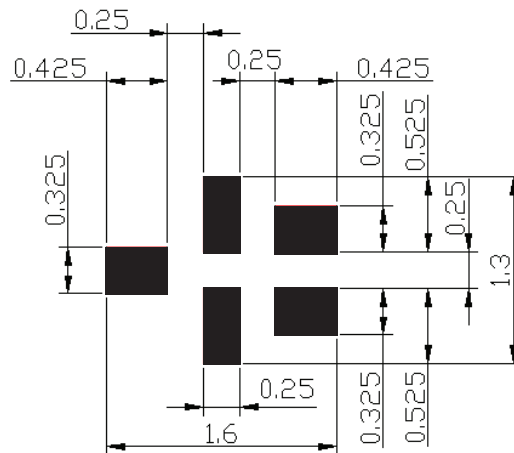

■ : Land Pattern

Unit : mm

Surface Mount 2436.00MHz SAW Filter

AFS14A72-2436.00-T2



RoHS
Compliant

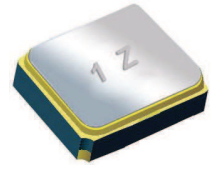

1.4 x 1.1 x 0.7 mm

FREQUENCY CHARACTERISTICS:

Filter Frequency Response (Narrowband)

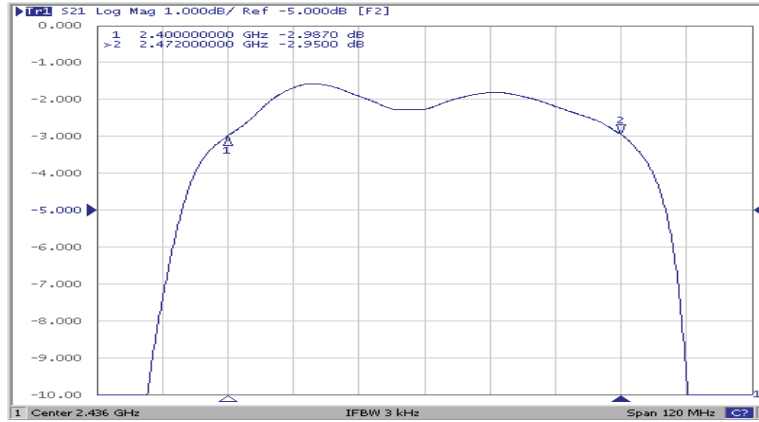

Filter Frequency Response (Wideband)

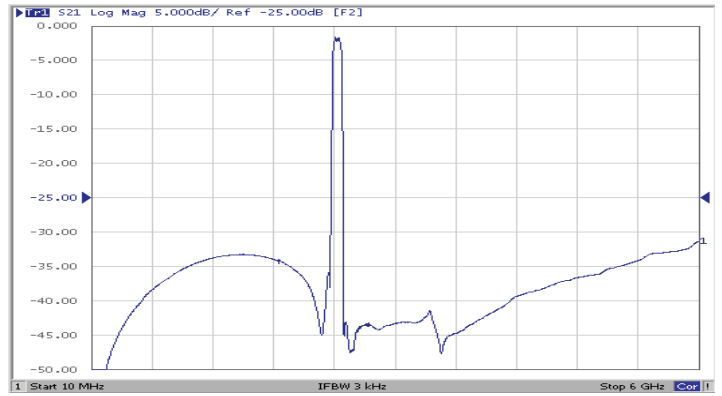
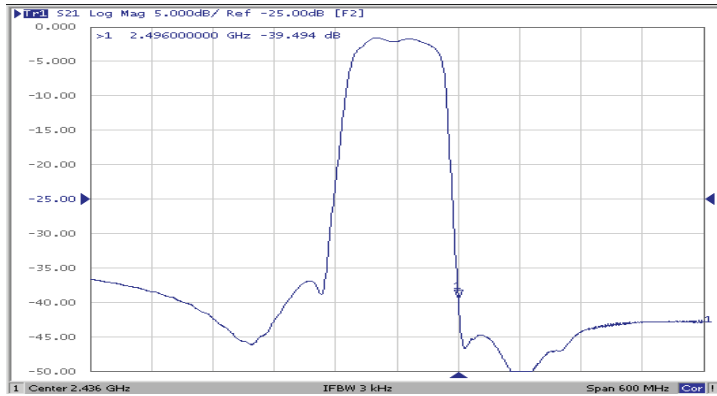

REFLECTION FUNCTIONS:

S11

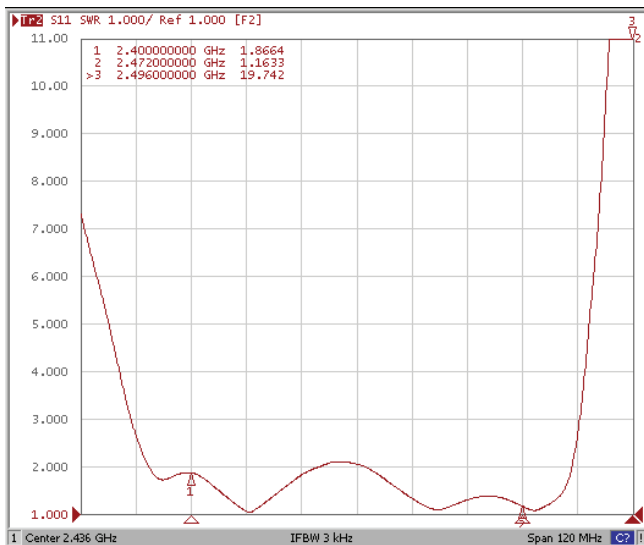

S22

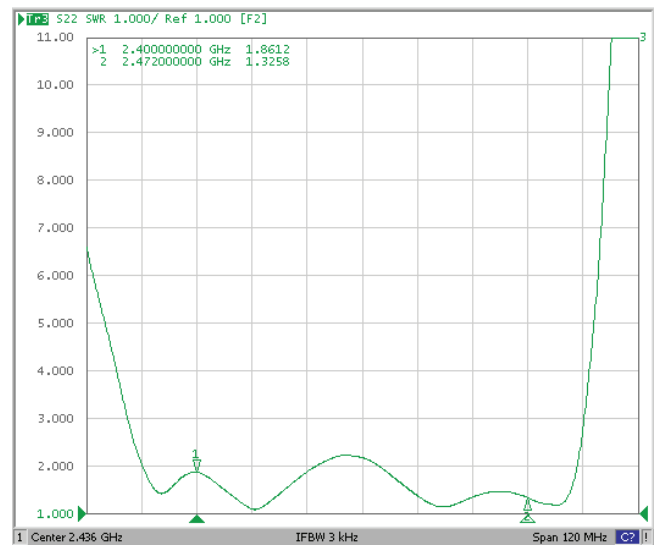

ABRACON IS
ISO 9001:2008
CERTIFIED



ABRACON
CORPORATION

Visit www.abracon.com for Terms & Conditions of Sale
30332 Esperanza, Rancho Santa Margarita, California 92688
tel 949-546-8000 | fax 949-546-8001 | www.abracon.com

Revised: 07.23.12

Surface Mount 2436.00MHz SAW Filter

AFS14A72-2436.00-T2

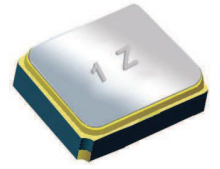

1.4 x 1.1 x 0.7 mm

REFLOW PROFILE:

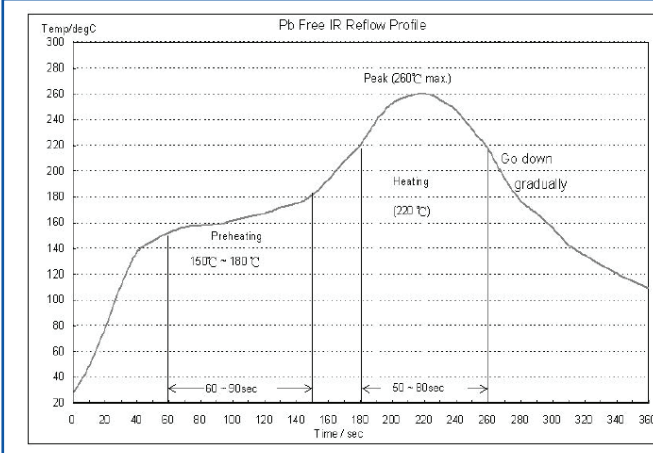

- Preheating shall be fixed at 150~180°C for 60~90 seconds.
- Ascending time to preheating temperature 150°C shall be 30 seconds min.
- Heating shall be fixed at 220°C for 50~80 seconds and at 250±10°C peak (max. 10sec). Time : 2 times

PACKAGING: 2000 Units/Reel

Reel Count : 7" = 2k units

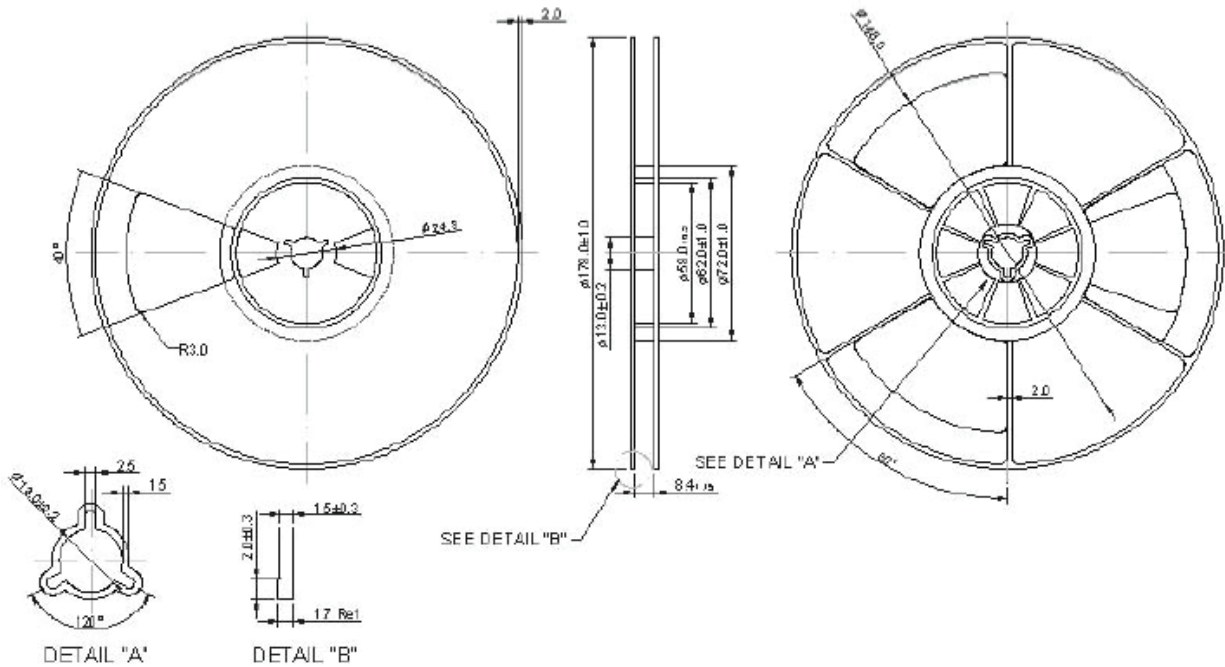

ATTENTION: Abracon Corporation's products are COTS – Commercial-Off-The-Shelf products; suitable for Commercial, Industrial and, where designated, Automotive Applications. Abracon's products are not specifically designed for Military, Aviation, Aerospace, Life-dependant Medical applications or any application requiring high reliability where component failure could result in loss of life and/or property. For applications requiring high reliability and/or presenting an extreme operating environment, written consent and authorization from Abracon Corporation is required. Please contact Abracon Corporation for more information.

ABRACON IS
ISO 9001:2008
CERTIFIED



Visit www.abracon.com for Terms & Conditions of Sale
30332 Esperanza, Rancho Santa Margarita, California 92688
tel 949-546-8000 | fax 949-546-8001 | www.abracon.com

Revised: 07.23.12