



Chipsmall Limited consists of a professional team with an average of over 10 year of expertise in the distribution of electronic components. Based in Hongkong, we have already established firm and mutual-benefit business relationships with customers from,Europe,America and south Asia,supplying obsolete and hard-to-find components to meet their specific needs.

With the principle of “Quality Parts,Customers Priority,Honest Operation,and Considerate Service”,our business mainly focus on the distribution of electronic components. Line cards we deal with include Microchip,ALPS,ROHM,Xilinx,Pulse,ON,Everlight and Freescale. Main products comprise IC,Modules,Potentiometer,IC Socket,Relay,Connector.Our parts cover such applications as commercial,industrial, and automotives areas.

We are looking forward to setting up business relationship with you and hope to provide you with the best service and solution. Let us make a better world for our industry!



Contact us

Tel: +86-755-8981 8866 Fax: +86-755-8427 6832

Email & Skype: info@chipsmall.com Web: www.chipsmall.com

Address: A1208, Overseas Decoration Building, #122 Zhenhua RD., Futian, Shenzhen, China



RF Power LDMOS Transistor

N-Channel Enhancement-Mode Lateral MOSFET

This 63 watt asymmetrical Doherty RF power LDMOS transistor is designed for cellular base station applications requiring very wide instantaneous bandwidth capability covering the frequency range of 1805 to 1880 MHz.

- Typical Doherty Single-Carrier W-CDMA Performance: $V_{DD} = 28$ Volts, $I_{DQA} = 1100$ mA, $V_{GSB} = 1.45$ Vdc, $P_{out} = 63$ Watts Avg., Input Signal PAR = 9.9 dB @ 0.01% Probability on CCDF.

Frequency	G_{ps} (dB)	η_D (%)	Output PAR (dB)	ACPR (dBc)	IRL (dB)
1805 MHz	14.8	48.1	7.3	-27.2	-13
1840 MHz	15.3	48.9	7.4	-27.7	-12
1880 MHz	15.2	48.3	7.5	-29.2	-9

Features

- Advanced High Performance In-Package Doherty
- Designed for Wide Instantaneous Bandwidth Applications
- Greater Negative Gate-Source Voltage Range for Improved Class C Operation
- Designed for Digital Predistortion Error Correction Systems
- In Tape and Reel. R6 Suffix = 150 Units, 56 mm Tape Width, 13-inch Reel. For R5 Tape and Reel option, see p. 15.

AFT18HW355SR6

1805-1880 MHz, 63 W AVG., 28 V

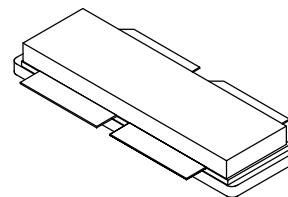

NI-1230S-4

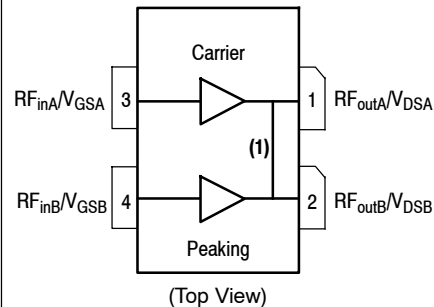

Figure 1. Pin Connections

1. Pin connections 1 and 2 are DC coupled and RF independent.

Table 1. Maximum Ratings

Rating	Symbol	Value	Unit
Drain-Source Voltage	V_{DSS}	-0.5, +65	Vdc
Gate-Source Voltage	V_{GS}	-6.0, +10	Vdc
Operating Voltage	V_{DD}	32, +0	Vdc
Storage Temperature Range	T_{stg}	-65 to +150	°C
Case Operating Temperature Range	T_C	-40 to +125	°C
Operating Junction Temperature Range (1,2)	T_J	-40 to +225	°C
CW Operation @ $T_C = 25^\circ\text{C}$ Derate above 25°C	CW	259 0.64	W W/°C

Table 2. Thermal Characteristics

Characteristic	Symbol	Value (2,3)	Unit
Thermal Resistance, Junction to Case Case Temperature 77°C , 63 W CW, 28 Vdc, $I_{DQA} = 1100$ mA, $V_{GSB} = 1.45$ Vdc, 1840 MHz Case Temperature 106°C , 225 W CW(4), 28 Vdc, $I_{DQA} = 1100$ mA, $V_{GSB} = 1.45$ Vdc, 1840 MHz	$R_{\theta JC}$	0.47 0.30	°C/W

Table 3. ESD Protection Characteristics

Test Methodology	Class
Human Body Model (per JESD22-A114)	2
Machine Model (per EIA/JESD22-A115)	B
Charge Device Model (per JESD22-C101)	IV

Table 4. Electrical Characteristics ($T_A = 25^\circ\text{C}$ unless otherwise noted)

Characteristic	Symbol	Min	Typ	Max	Unit
----------------	--------	-----	-----	-----	------

Off Characteristics (5)

Zero Gate Voltage Drain Leakage Current ($V_{DS} = 65$ Vdc, $V_{GS} = 0$ Vdc)	I_{DSS}	—	—	10	μAdc
Zero Gate Voltage Drain Leakage Current ($V_{DS} = 28$ Vdc, $V_{GS} = 0$ Vdc)	I_{DSS}	—	—	5	μAdc
Gate-Source Leakage Current ($V_{GS} = 5$ Vdc, $V_{DS} = 0$ Vdc)	I_{GSS}	—	—	1	μAdc

On Characteristics - Side A (5) (Carrier)

Gate Threshold Voltage ($V_{DS} = 10$ Vdc, $I_D = 146$ μAdc)	$V_{GS(th)}$	1.6	2.1	2.6	Vdc
Gate Quiescent Voltage ($V_{DD} = 28$ Vdc, $I_{DA} = 1100$ mAdc, Measured in Functional Test)	$V_{GS(Q)}$	2.4	2.9	3.4	Vdc
Drain-Source On-Voltage ($V_{GS} = 10$ Vdc, $I_D = 1.5$ Adc)	$V_{DS(on)}$	0.1	0.2	0.3	Vdc

On Characteristics - Side B (5) (Peaking)

Gate Threshold Voltage ($V_{DS} = 10$ Vdc, $I_D = 291$ μAdc)	$V_{GS(th)}$	1.6	2.1	2.6	Vdc
Drain-Source On-Voltage ($V_{GS} = 10$ Vdc, $I_D = 2.9$ Adc)	$V_{DS(on)}$	0.1	0.2	0.3	Vdc

1. Continuous use at maximum temperature will affect MTTF.
2. MTTF calculator available at <http://www.freescale.com/rtf>. Select Software & Tools/Development Tools/Calculators to access MTTF calculators by product.
3. Refer to AN1955, *Thermal Measurement Methodology of RF Power Amplifiers*. Go to <http://www.freescale.com/rtf>. Select Documentation/Application Notes - AN1955.
4. Exceeds recommended operating conditions. See CW operation data in Maximum Ratings table.
5. Each side of device measured separately.

(continued)

Table 4. Electrical Characteristics ($T_A = 25^\circ\text{C}$ unless otherwise noted) (continued)

Characteristic	Symbol	Min	Typ	Max	Unit
Functional Tests (1,2,3) (In Freescale Doherty Test Fixture, 50 ohm system) $V_{DD} = 28\text{ Vdc}$, $I_{DQA} = 1100\text{ mA}$, $V_{GSB} = 1.45\text{ Vdc}$, $P_{out} = 63\text{ W Avg.}$, $f = 1880\text{ MHz}$, Single-Carrier W-CDMA, IQ Magnitude Clipping, Input Signal PAR = 9.9 dB @ 0.01% Probability on CCDF. ACPR measured in 3.84 MHz Channel Bandwidth @ $\pm 5\text{ MHz}$ Offset.					
Power Gain	G_{ps}	14.2	15.2	17.0	dB
Drain Efficiency	η_D	45.0	48.3	—	%
Output Peak-to-Average Ratio @ 0.01% Probability on CCDF	PAR	7.1	7.5	—	dB
Adjacent Channel Power Ratio	ACPR	—	-29.2	-26.0	dBc
Input Return Loss	IRL	—	-9	-8	dB

Load Mismatch (In Freescale Doherty Test Fixture, 50 ohm system) $I_{DQA} = 1100\text{ mA}$, $V_{GSB} = 1.45\text{ Vdc}$, $f_1 = 1795\text{ MHz}$, $f_2 = 1895\text{ MHz}$, 2-Carrier W-CDMA, 3.84 MHz Channel Bandwidth Carriers. PAR = 9.9 dB @ 0.01% Probability on CCDF.

VSWR 10:1 at 32 Vdc, 252 W W-CDMA Output Power	No Device Degradation
--	-----------------------

Typical Performances (2) (In Freescale Doherty Test Fixture, 50 ohm system) $V_{DD} = 28\text{ Vdc}$, $I_{DQA} = 1100\text{ mA}$, $V_{GSB} = 1.45\text{ Vdc}$, 1805-1880 MHz Bandwidth

P_{out} @ 1 dB Compression Point, CW	P1dB	—	350 (4,5)	—	W
P_{out} @ 3 dB Compression Point (6)	P3dB	—	400	—	W
AM/PM (Maximum value measured at the P3dB compression point across the 1805-1880 MHz frequency range)	ϕ	—	22	—	$^\circ$
VBW Resonance Point (IMD Third Order Intermodulation Inflection Point)	VBW_{res}	—	150	—	MHz
Gain Flatness in 75 MHz Bandwidth @ $P_{out} = 63\text{ W Avg.}$	G_F	—	0.63	—	dB
Gain Variation over Temperature (-30°C to $+85^\circ\text{C}$)	ΔG	—	0.01	—	dB/ $^\circ\text{C}$
Output Power Variation over Temperature (-30°C to $+85^\circ\text{C}$) (5)	ΔP_{1dB}	—	0.013	—	dB/ $^\circ\text{C}$

1. Part internally matched both on input and output.
2. V_{DDA} and V_{ddb} must be tied together and powered by a single DC power supply.
3. Measurement made with device in an asymmetrical Doherty configuration.
4. Calculated from load pull P3dB measurements.
5. Exceeds recommended operating conditions. See CW operation data in Maximum Ratings table.
6. $P_{3dB} = P_{avg} + 7.0\text{ dB}$ where P_{avg} is the average output power measured using an unclipped W-CDMA single-carrier input signal where output PAR is compressed to 7.0 dB @ 0.01% probability on CCDF.

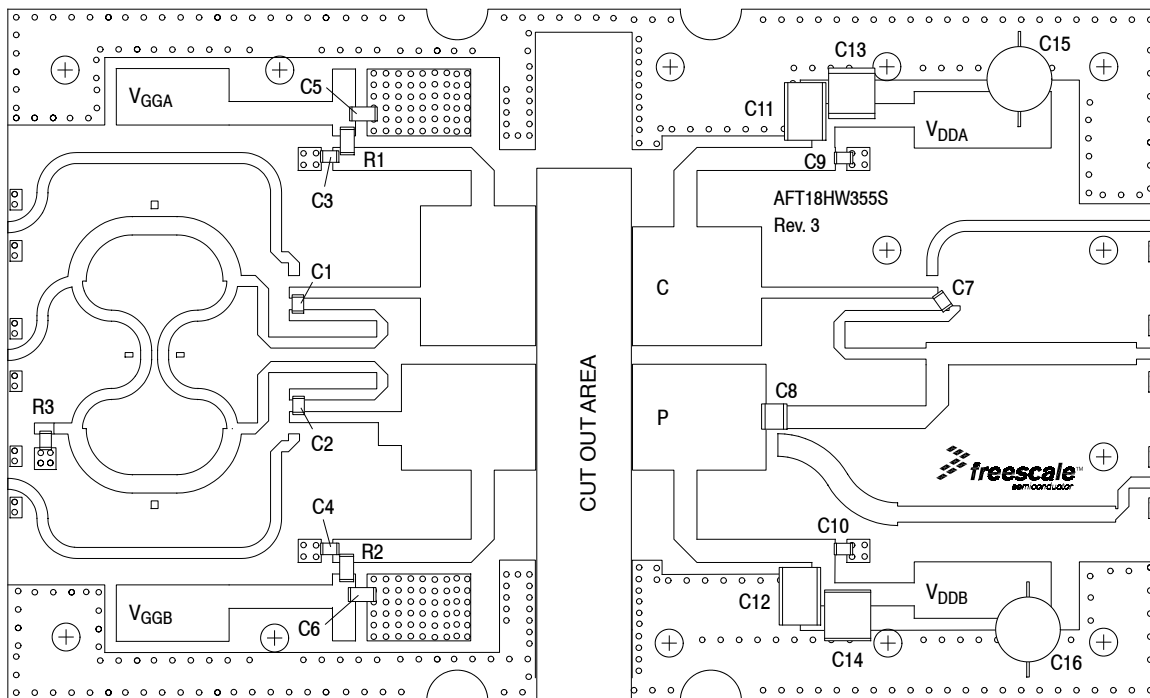

Note 1: V_{DDA} and V_{DDB} must be tied together and powered by a single DC power supply.

Figure 2. AFT18HW355SR6 Test Circuit Component Layout

Table 5. AFT18HW355SR6 Test Circuit Component Designations and Values

Part	Description	Part Number	Manufacturer
C1, C2, C3, C4, C7, C9, C10	18 pF Chip Capacitors	GQM2195C2A180JB12D	Murata
C5, C6	2.2 μ F Chip Capacitors	C1206C225K4RAC	Kemet
C8	8.2 pF Chip Capacitor	ATC100B8R2CT500XT	ATC
C11, C12	2.2 μ F Chip Capacitors	C1825C225K5RAC	Kemet
C13, C14	22 μ F Chip Capacitors	C5750Y5V1H226Z	TDK
C15, C16	470 μ F, 63 V Electrolytic Capacitors	MCGPR63V477M13X26-RH	Multicomp
R1, R2	2.2 Ω , 1/4 W Chip Resistors	CRCW12062R20JNEA	Vishay
R3	50 Ω , 10 W Chip Resistor	81A7031-50-5F	Florida RF Labs
PCB	0.020", $\epsilon_r = 3.5$	RO4350B	Rogers

TYPICAL CHARACTERISTICS

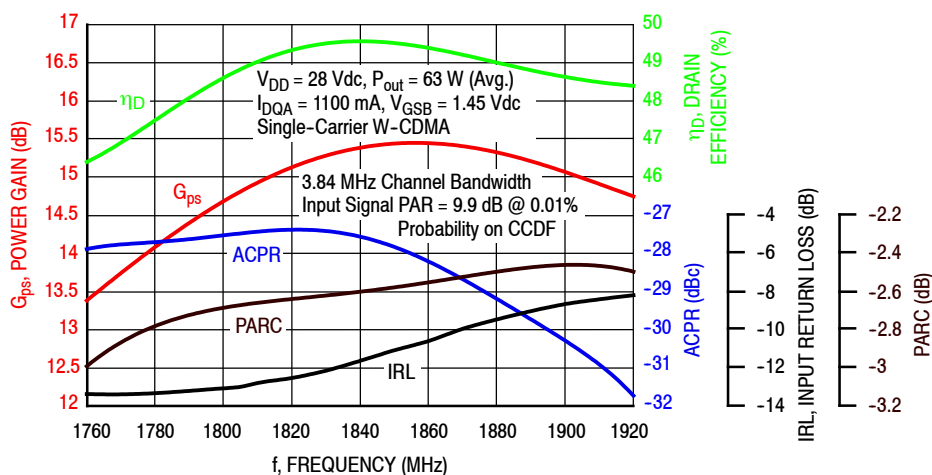

Figure 3. Single-Carrier Output Peak-to-Average Ratio Compression (PARC) Broadband Performance @ $P_{out} = 63$ Watts Avg.

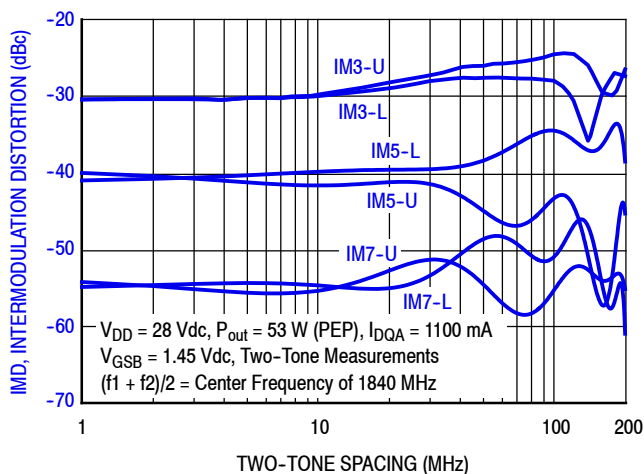

Figure 4. Intermodulation Distortion Products versus Two-Tone Spacing

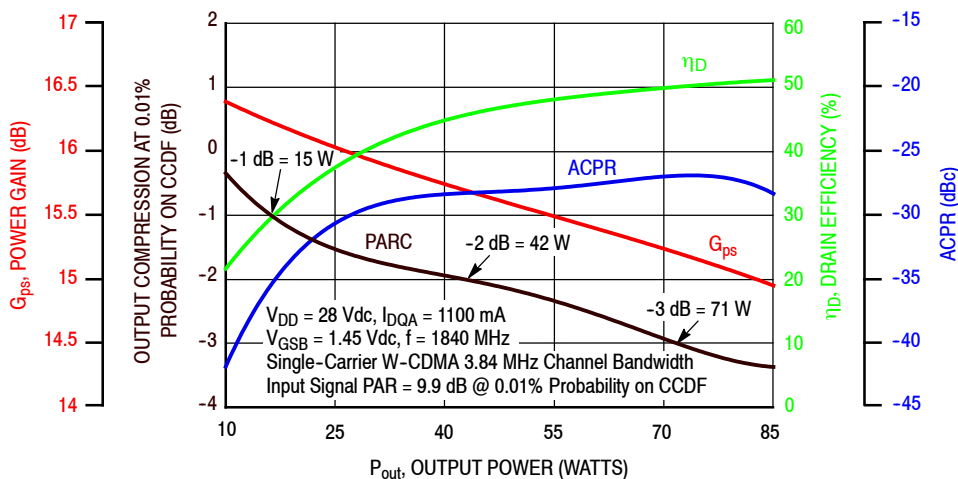

Figure 5. Output Peak-to-Average Ratio Compression (PARC) versus Output Power

TYPICAL CHARACTERISTICS

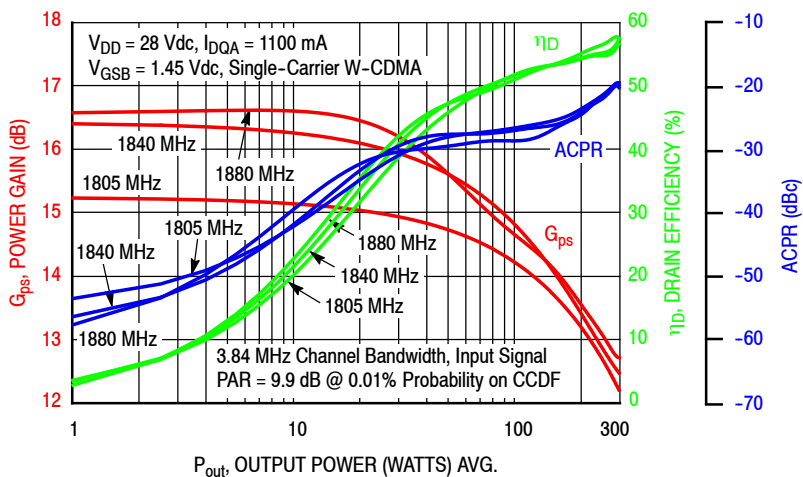

Figure 6. Single-Carrier W-CDMA Power Gain, Drain Efficiency and ACPR versus Output Power

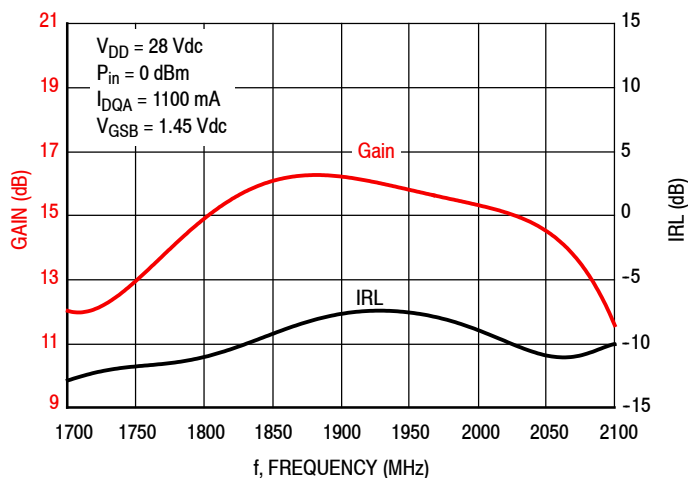

Figure 7. Broadband Frequency Response

$V_{DD} = 28 \text{ Vdc}$, $I_{DQA} = 1100 \text{ mA}$, Pulsed CW, 10 $\mu\text{sec(ON)}$, 10% Duty Cycle

f (MHz)	Z_{source} (Ω)	Z_{in} (Ω)	$Z_{\text{load}}^{(1)}$ (Ω)	Max Linear Gain (dB)	Max Output Power							
					P1dB				P3dB			
					(dBm)	(W)	η_D (%)	AM/PM ($^\circ$)	(dBm)	(W)	η_D (%)	AM/PM ($^\circ$)
1805	1.14 - j4.15	1.12 + j4.37	1.21 - j4.03	18.3	51.8	151	58.1	9.2	52.7	186	60.0	15
1840	1.14 - j4.41	1.32 + j4.55	1.24 - j4.24	18.4	51.6	145	57.4	9.1	52.6	182	59.4	16
1880	1.54 - j4.56	1.61 + j4.79	1.23 - j4.39	18.2	51.7	148	56.6	9.2	52.6	182	58.3	15

(1) Load impedance for optimum P1dB power.

Z_{source} = Measured impedance presented to the input of the device at the package reference plane.

Z_{in} = Impedance as measured from gate contact to ground.

Z_{load} = Measured impedance presented to the output of the device at the package reference plane.

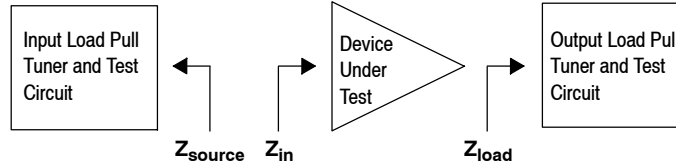

Figure 8. Carrier Side Load Pull Performance — Maximum P1dB Tuning

$V_{DD} = 28 \text{ Vdc}$, $I_{DQA} = 1100 \text{ mA}$, Pulsed CW, 10 $\mu\text{sec(ON)}$, 10% Duty Cycle

f (MHz)	Z_{source} (Ω)	Z_{in} (Ω)	$Z_{\text{load}}^{(1)}$ (Ω)	Max Linear Gain (dB)	Max Drain Efficiency							
					P1dB				P3dB			
					(dBm)	(W)	η_D (%)	AM/PM ($^\circ$)	(dBm)	(W)	η_D (%)	AM/PM ($^\circ$)
1805	1.14 - j4.15	1.08 + j4.44	2.56 - j3.08	21.1	49.9	98	69.8	15	50.6	115	71.8	24
1840	1.14 - j4.41	1.25 + j4.64	2.54 - j2.75	21.6	49.3	85	68.9	16	50.6	115	71.2	26
1880	1.54 - j4.56	1.53 + j4.87	2.30 - j3.10	21.3	49.6	91	68.1	16	50.6	115	70.1	26

(1) Load impedance for optimum P1dB efficiency.

Z_{source} = Measured impedance presented to the input of the device at the package reference plane.

Z_{in} = Impedance as measured from gate contact to ground.

Z_{load} = Measured impedance presented to the output of the device at the package reference plane.

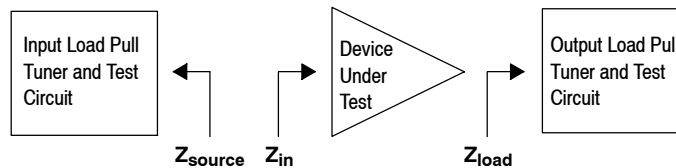

Figure 9. Carrier Side Load Pull Performance — Maximum Drain Efficiency Tuning

$V_{DD} = 28 \text{ Vdc}$, $V_{GSB} = 1.7 \text{ Vdc}$, Pulsed CW, 10 $\mu\text{sec}(\text{on})$, 10% Duty Cycle

f (MHz)	$Z_{\text{source}} (\Omega)$	$Z_{\text{in}} (\Omega)$	$Z_{\text{load}}^{(1)} (\Omega)$	Max Linear Gain (dB)	Max Output Power							
					P1dB				P3dB			
					(dBm)	(W)	η_D (%)	AM/PM (°)	(dBm)	(W)	η_D (%)	AM/PM (°)
1805	0.88 - j3.59	0.97 + j3.83	1.35 - j4.28	15.1	54.8	302	57.0	29	54.9	309	64.7	39
1840	1.07 - j3.87	1.25 + j4.16	1.37 - j4.53	15.0	54.7	295	55.3	29	55.2	331	61.4	38
1880	1.66 - j4.15	1.80 + j4.58	1.56 - j4.77	15.1	54.6	288	55.6	28	55.3	339	58.8	36

(1) Load impedance for optimum P1dB power.

Z_{source} = Measured impedance presented to the input of the device at the package reference plane.

Z_{in} = Impedance as measured from gate contact to ground.

Z_{load} = Measured impedance presented to the output of the device at the package reference plane.

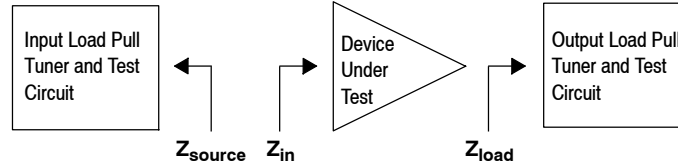

Figure 10. Peaking Side Load Pull Performance — Maximum P1dB Tuning

$V_{DD} = 28 \text{ Vdc}$, $V_{GSB} = 1.7 \text{ Vdc}$, Pulsed CW, 10 $\mu\text{sec}(\text{on})$, 10% Duty Cycle

f (MHz)	$Z_{\text{source}} (\Omega)$	$Z_{\text{in}} (\Omega)$	$Z_{\text{load}}^{(1)} (\Omega)$	Max Linear Gain (dB)	Max Drain Efficiency							
					P1dB				P3dB			
					(dBm)	(W)	η_D (%)	AM/PM (°)	(dBm)	(W)	η_D (%)	AM/PM (°)
1805	0.88 - j3.59	0.86 + j3.78	2.24 - j2.33	16.7	52.4	174	72.4	36	53.2	209	72.0	45
1840	1.07 - j3.87	1.10 + j4.10	2.05 - j2.42	16.8	52.3	170	71.6	37	53.2	209	71.0	46
1880	1.66 - j4.15	1.59 + j4.49	2.08 - j2.52	16.6	52.1	162	70.4	36	53.1	204	70.0	44

(1) Load impedance for optimum P1dB efficiency.

Z_{source} = Measured impedance presented to the input of the device at the package reference plane.

Z_{in} = Impedance as measured from gate contact to ground.

Z_{load} = Measured impedance presented to the output of the device at the package reference plane.

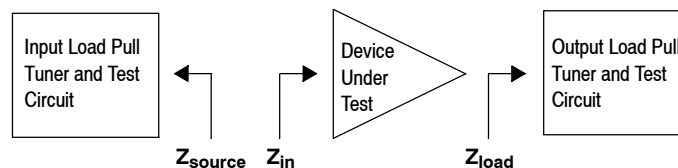

Figure 11. Peaking Side Load Pull Performance — Maximum Drain Efficiency Tuning

P1dB - TYPICAL CARRIER SIDE LOAD PULL CONTOURS — 1840 MHz

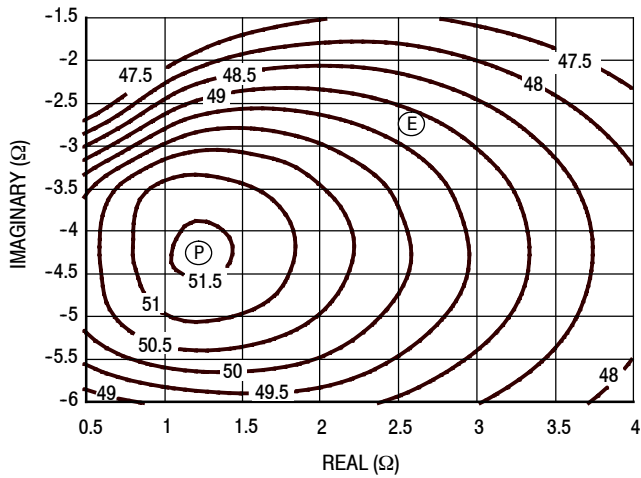

Figure 12. P1dB Load Pull Output Power Contours (dBm)

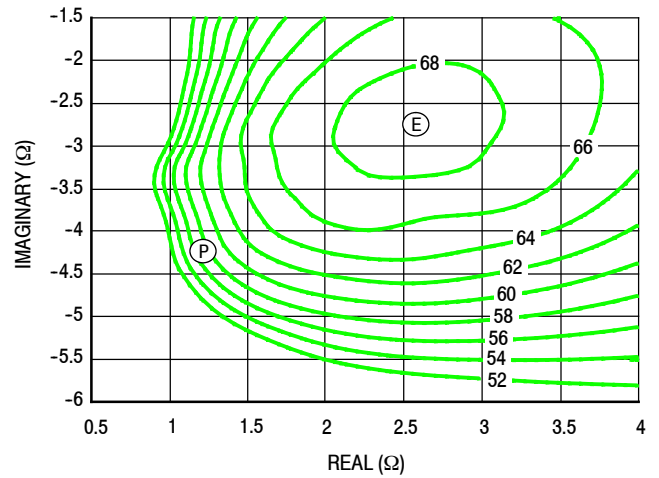

Figure 13. P1dB Load Pull Efficiency Contours (%)

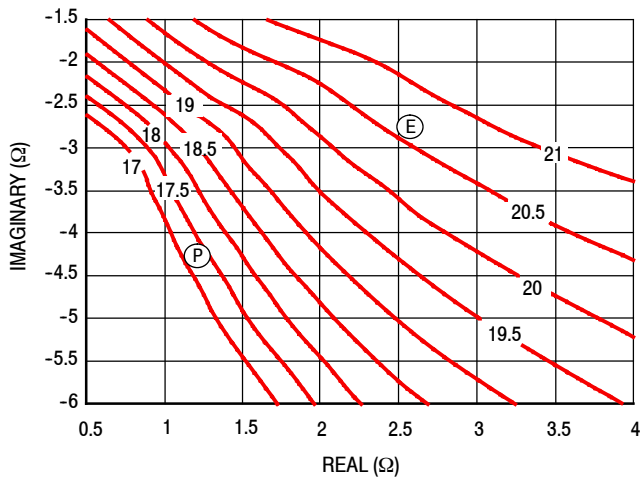

Figure 14. P1dB Load Pull Gain Contours (dB)

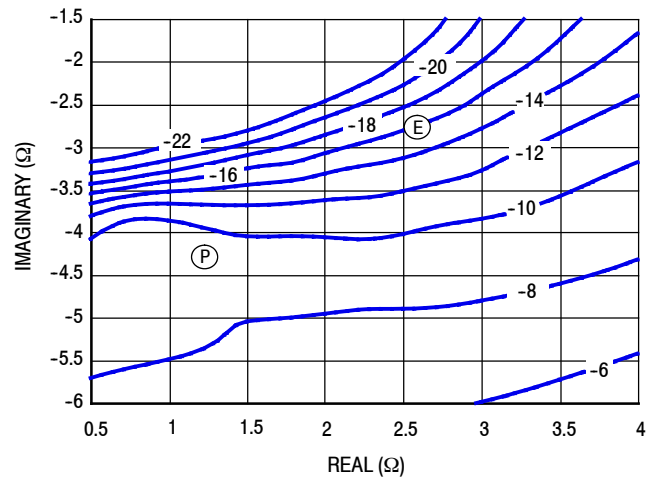

Figure 15. P1dB Load Pull AM/PM Contours (°)

NOTE: (P) = Maximum Output Power

(E) = Maximum Drain Efficiency

- Power Gain
- Drain Efficiency
- Linearity
- Output Power

P3dB - TYPICAL CARRIER SIDE LOAD PULL CONTOURS — 1840 MHz

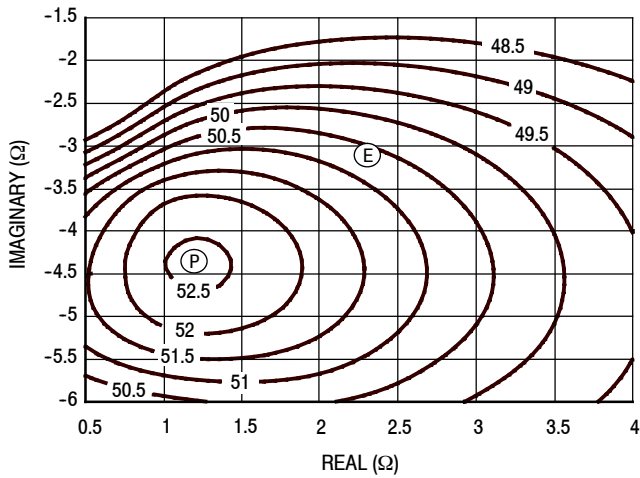

Figure 16. P3dB Load Pull Output Power Contours (dBm)

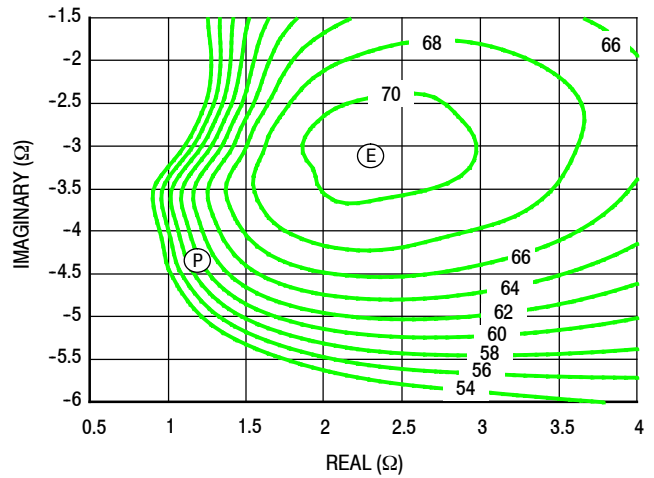

Figure 17. P3dB Load Pull Efficiency Contours (%)

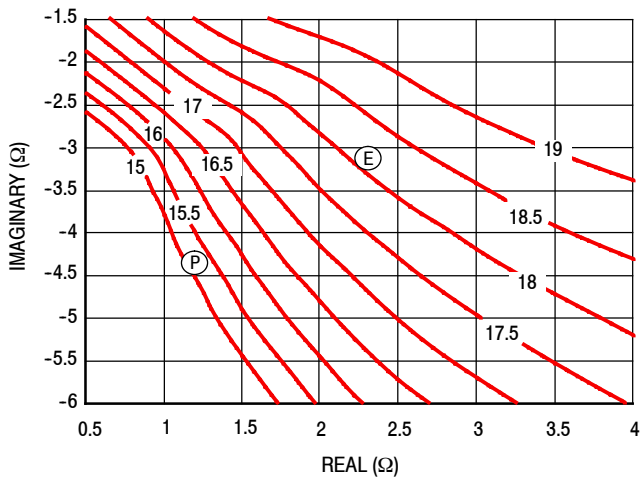

Figure 18. P3dB Load Pull Gain Contours (dB)

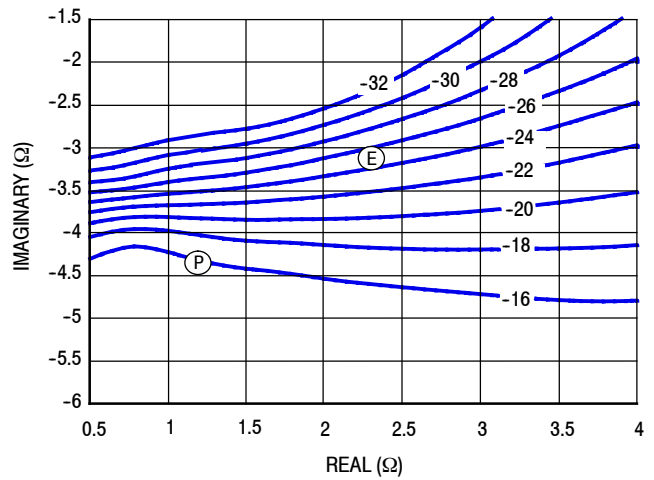

Figure 19. P3dB Load Pull AM/PM Contours (°)

NOTE: (P) = Maximum Output Power
 (E) = Maximum Drain Efficiency

- Power Gain
- Drain Efficiency
- Linearity
- Output Power

P1dB - TYPICAL PEAKING SIDE LOAD PULL CONTOURS — 1840 MHz

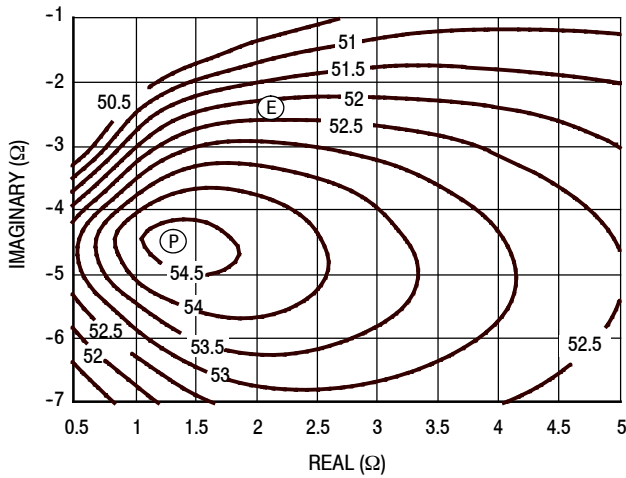

Figure 20. P1dB Load Pull Output Power Contours (dBm)

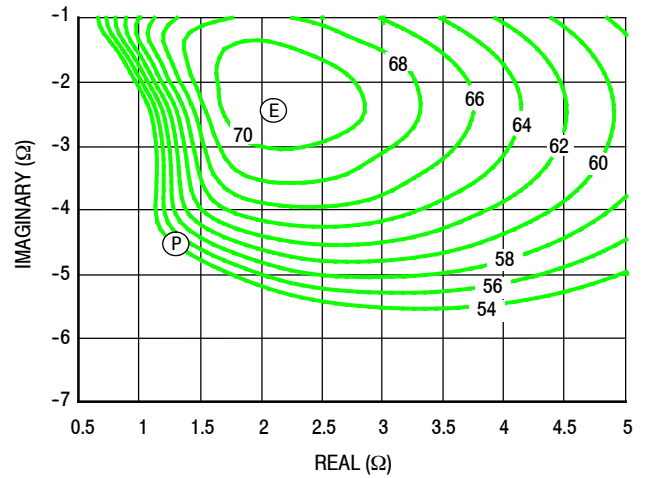

Figure 21. P1dB Load Pull Efficiency Contours (%)

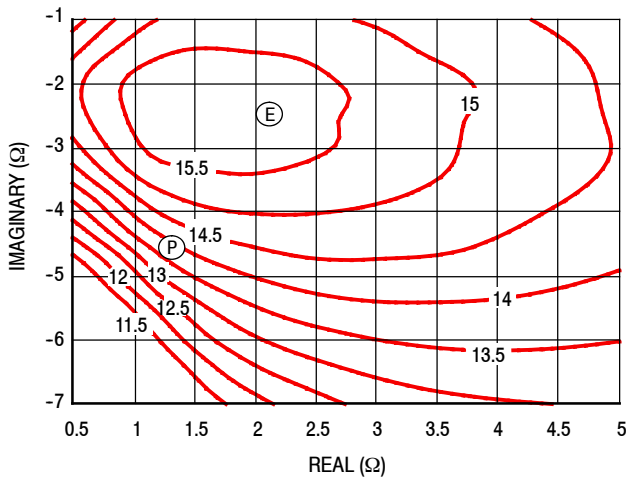

Figure 22. P1dB Load Pull Gain Contours (dB)

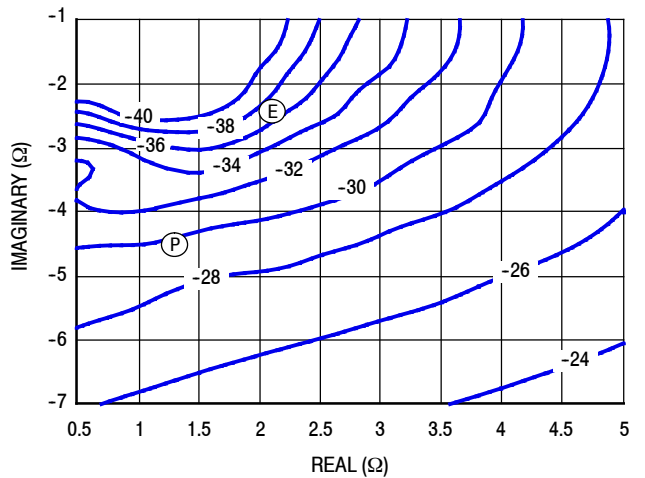

Figure 23. P1dB Load Pull AM/PM Contours (°)

NOTE: (P) = Maximum Output Power

(E) = Maximum Drain Efficiency

- Power Gain
- Drain Efficiency
- Linearity
- Output Power

P3dB - TYPICAL PEAKING SIDE LOAD PULL CONTOURS — 1840 MHz

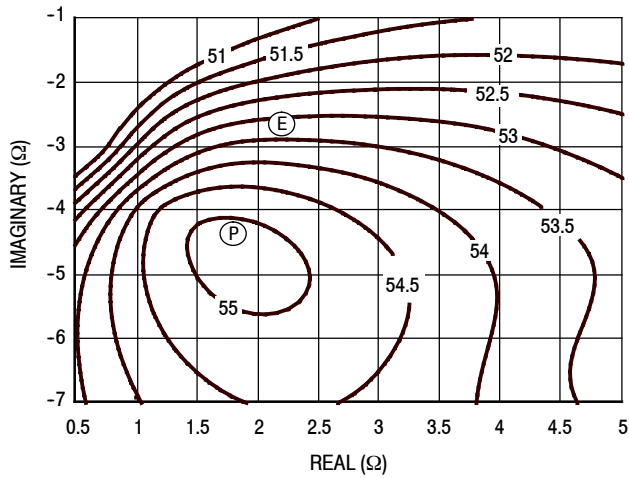

Figure 24. P3dB Load Pull Output Power Contours (dBm)

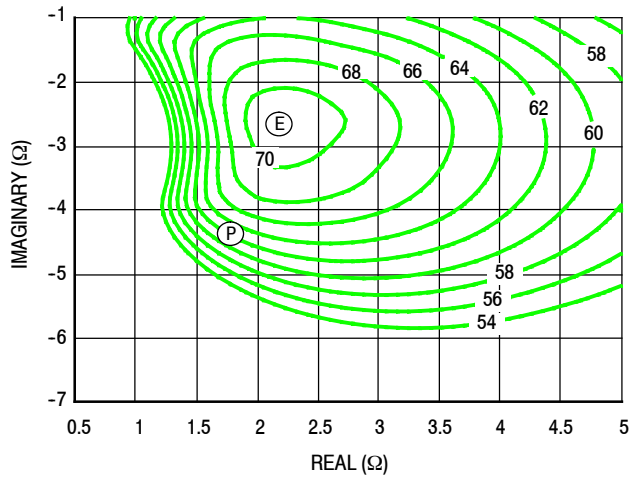

Figure 25. P3dB Load Pull Efficiency Contours (%)

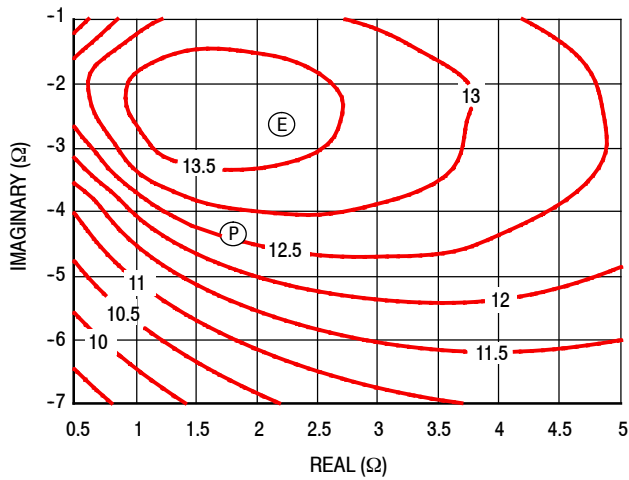

Figure 26. P3dB Load Pull Gain Contours (dB)

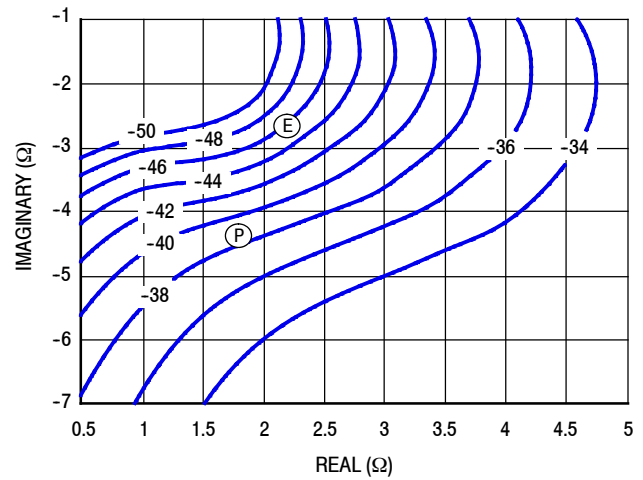
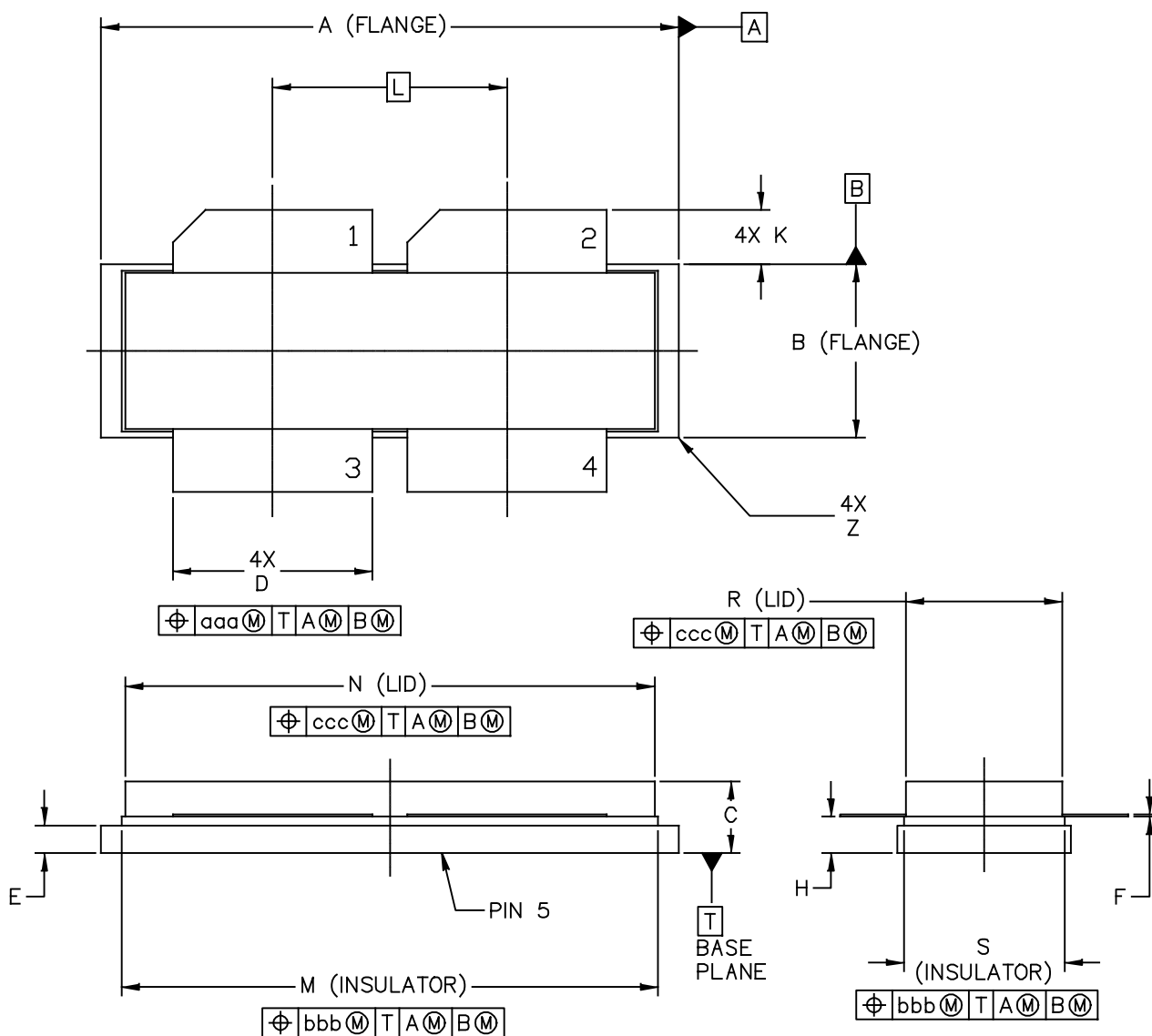

Figure 27. P3dB Load Pull AM/PM Contours (°)

NOTE: (P) = Maximum Output Power
 (E) = Maximum Drain Efficiency

- Power Gain
- Drain Efficiency
- Linearity
- Output Power

PACKAGE DIMENSIONS



© FREESCALE SEMICONDUCTOR, INC. ALL RIGHTS RESERVED.		MECHANICAL OUTLINE		PRINT VERSION NOT TO SCALE	
TITLE: NI-1230S		DOCUMENT NO: 98ARB18247C		REV: F	
		CASE NUMBER: 375E-04		05 AUG 2005	
		STANDARD: NON-JEDEC			

NOTES:

1. INTERPRET DIMENSIONS AND TOLERANCES PER ASME Y14.5M-1994.
2. CONTROLLING DIMENSION: INCH
3. DIMENSION H IS MEASURED .030 AWAY FROM PACKAGE BODY

STYLE 1:

- PIN 1 - DRAIN
- 2 - DRAIN
- 3 - GATE
- 4 - GATE
- 5 - SOURCE

DIM	INCHES		MILLIMETERS		DIM	INCHES		MILLIMETERS	
	MIN	MAX	MIN	MAX		MIN	MAX	MIN	MAX
A	1.265	1.275	32.13	32.38	R	.355	.365	9.01	9.27
B	.395	.405	10.03	10.29	S	.365	.375	9.27	9.53
C	.150	.200	3.81	5.08	Z	---	.040	---	1.02
D	.455	.465	11.56	11.81					
E	.062	.066	1.57	1.68	aaa	.013		0.33	
F	.004	.007	0.1	0.18	bbb	.010		0.25	
H	.082	.090	2.08	2.29	ccc	.020		0.51	
K	.117	.137	2.97	3.48					
L	.540 BSC		13.72 BSC						
M	1.219	1.241	30.96	31.52					
N	1.218	1.242	30.94	31.55					
© FREESCALE SEMICONDUCTOR, INC. ALL RIGHTS RESERVED.			MECHANICAL OUTLINE			PRINT VERSION NOT TO SCALE			
TITLE: NI-1230S					DOCUMENT NO: 98ARB18247C			REV: F	
					CASE NUMBER: 375E-04			05 AUG 2005	
					STANDARD: NON-JEDEC				

PRODUCT DOCUMENTATION, SOFTWARE AND TOOLS

Refer to the following documents, software and tools to aid your design process.

Application Notes

- AN1955: Thermal Measurement Methodology of RF Power Amplifiers

Engineering Bulletins

- EB212: Using Data Sheet Impedances for RF LDMOS Devices

Software

- Electromigration MTTF Calculator
- RF High Power Model
- .s2p File

Development Tools

- Printed Circuit Boards

For Software and Tools, do a Part Number search at <http://www.freescale.com>, and select the “Part Number” link. Go to the Software & Tools tab on the part’s Product Summary page to download the respective tool.

R5 TAPE AND REEL OPTION

The R5 tape and reel option for AFT18HW355S part will be available for 2 years after release of AFT18HW355S. Freescale Semiconductor, Inc. reserves the right to limit the quantities that will be delivered in the R5 tape and reel option. At the end of the 2 year period customers who have purchased this device in the R5 tape and reel option will be offered AFT18HW355S in the R6 tape and reel option.

REVISION HISTORY

The following table summarizes revisions to this document.

Revision	Date	Description
0	Jan. 2013	<ul style="list-style-type: none"> • Initial Release of Data Sheet
1	Jan. 2013	<ul style="list-style-type: none"> • Typical Performance frequency table: updated values to show statistical broadband performance, p. 1 • Maximum Ratings table: added CW operation showing 25°C maximum CW rating limitation, p. 2 • Functional Tests table: updated typical values to reflect 1880 MHz typical performance values from p. 1 Typical Performance frequency table, changed Power Gain minimum value from 42.0% to 45.0%, p. 3 • Load Mismatch table: updated VSWR output power rating to a higher 2-carrier W-CDMA value, p. 3 • Typical Performance table: added footnote 5 to align with data in table, p. 3 • Fig. 10, Peaking Side Load Pull Performance — Maximum P1dB Tuning: corrected V_{GSB} from 1.45 Vdc to 1.7 Vdc, p. 8 • Fig. 11, Peaking Side Load Pull Performance — Maximum Drain Efficiency Tuning: corrected V_{GSB} from 1.45 Vdc to 1.7 Vdc, p. 8

How to Reach Us:

Home Page:
freescale.com

Web Support:
freescale.com/support

Information in this document is provided solely to enable system and software implementers to use Freescale products. There are no express or implied copyright licenses granted hereunder to design or fabricate any integrated circuits based on the information in this document.

Freescale reserves the right to make changes without further notice to any products herein. Freescale makes no warranty, representation, or guarantee regarding the suitability of its products for any particular purpose, nor does Freescale assume any liability arising out of the application or use of any product or circuit, and specifically disclaims any and all liability, including without limitation consequential or incidental damages. "Typical" parameters that may be provided in Freescale data sheets and/or specifications can and do vary in different applications, and actual performance may vary over time. All operating parameters, including "typicals," must be validated for each customer application by customer's technical experts. Freescale does not convey any license under its patent rights nor the rights of others. Freescale sells products pursuant to standard terms and conditions of sale, which can be found at the following address: freescale.com/SalesTermsandConditions.

Freescale, the Freescale logo, Altivec, C-5, CodeTest, CodeWarrior, ColdFire, C-Ware, Energy Efficient Solutions logo, Kinetis, mobileGT, PowerQUICC, Processor Expert, QorIQ, Qorivva, StarCore, Symphony, and VortiQa are trademarks of Freescale Semiconductor, Inc., Reg. U.S. Pat. & Tm. Off. Airfast, BeeKit, BeeStack, ColdFire+, CoreNet, Flexis, MagniV, MXC, Platform in a Package, QorIQ Qonverge, QUICC Engine, Ready Play, SafeAssure, SMARTMOS, TurboLink, Vybrid, and Xtrinsic are trademarks of Freescale Semiconductor, Inc. All other product or service names are the property of their respective owners.

© 2013 Freescale Semiconductor, Inc.