



Chipsmall Limited consists of a professional team with an average of over 10 year of expertise in the distribution of electronic components. Based in Hongkong, we have already established firm and mutual-benefit business relationships with customers from,Europe,America and south Asia,supplying obsolete and hard-to-find components to meet their specific needs.

With the principle of “Quality Parts,Customers Priority,Honest Operation,and Considerate Service”,our business mainly focus on the distribution of electronic components. Line cards we deal with include Microchip,ALPS,ROHM,Xilinx,Pulse,ON,Everlight and Freescale. Main products comprise IC,Modules,Potentiometer,IC Socket,Relay,Connector.Our parts cover such applications as commercial,industrial, and automotives areas.

We are looking forward to setting up business relationship with you and hope to provide you with the best service and solution. Let us make a better world for our industry!



Contact us

Tel: +86-755-8981 8866 Fax: +86-755-8427 6832

Email & Skype: info@chipsmall.com Web: www.chipsmall.com

Address: A1208, Overseas Decoration Building, #122 Zhenhua RD., Futian, Shenzhen, China



IGLOO Low Power Flash FPGAs

with Flash*Freeze Technology

Features and Benefits

Low Power

- 1.2 V to 1.5 V Core Voltage Support for Low Power
- Supports Single-Voltage System Operation
- 5 μ W Power Consumption in Flash*Freeze Mode
- Low Power Active FPGA Operation
- Flash*Freeze Technology Enables Ultra-Low Power Consumption while Maintaining FPGA Content
- Easy Entry to / Exit from Ultra-Low Power Flash*Freeze Mode

High Capacity

- 15K to 1 Million System Gates
- Up to 144 Kbits of True Dual-Port SRAM
- Up to 300 User I/Os

Reprogrammable Flash Technology

- 130-nm, 7-Layer Metal, Flash-Based CMOS Process
- Instant On Level 0 Support
- Single-Chip Solution
- Retains Programmed Design When Powered Off
- 250 MHz (1.5 V systems) and 160 MHz (1.2 V systems) System Performance

In-System Programming (ISP) and Security

- ISP Using On-Chip 128-Bit Advanced Encryption Standard (AES) Decryption (except ARM®-enabled IGLOO® devices) via JTAG (IEEE 1532-compliant)[†]
- FlashLock® Designed to Secure FPGA Contents

High-Performance Routing Hierarchy

- Segmented, Hierarchical Routing and Clock Structure

Advanced I/O

- 700 Mbps DDR, LVDS-Capable I/Os (AGL250 and above)
- 1.2 V, 1.5 V, 1.8 V, 2.5 V, and 3.3 V Mixed-Voltage Operation

- Bank-Selectable I/O Voltages—up to 4 Banks per Chip
- Single-Ended I/O Standards: LVTTTL, LVCMOS 3.3 V / 2.5 V / 1.8 V / 1.5 V / 1.2 V, 3.3 V PCI / 3.3 V PCI-X[†], and LVCMOS 2.5 V / 5.0 V Input[†]
- Differential I/O Standards: LVPECL, LVDS, B-LVDS, and M-LVDS (AGL250 and above)
- Wide Range Power Supply Voltage Support per JESD8-B, Allowing I/Os to Operate from 2.7 V to 3.6 V
- Wide Range Power Supply Voltage Support per JESD8-12, Allowing I/Os to Operate from 1.14 V to 1.575 V
- I/O Registers on Input, Output, and Enable Paths
- Hot-Swappable and Cold-Sparing I/Os[‡]
- Programmable Output Slew Rate[†] and Drive Strength
- Weak Pull-Up/-Down
- IEEE 1149.1 (JTAG) Boundary Scan Test
- Pin-Compatible Packages across the IGLOO Family

Clock Conditioning Circuit (CCC) and PLL[‡]

- Six CCC Blocks, One with an Integrated PLL
- Configurable Phase Shift, Multiply/Divide, Delay Capabilities, and External Feedback
- Wide Input Frequency Range (1.5 MHz up to 250 MHz)

Embedded Memory

- 1 kbit of FlashROM User Nonvolatile Memory
- SRAMs and FIFOs with Variable-Aspect-Ratio 4,608-Bit[†] RAM Blocks ($\times 1$, $\times 2$, $\times 4$, $\times 9$, and $\times 18$ organizations)
- True Dual-Port SRAM (except $\times 18$)[†]

ARM Processor Support in IGLOO FPGAs

- M1 IGLOO Devices—Cortex®-M1 Soft Processor Available with or without Debug

IGLOO Devices	AGL015 ¹	AGL030	AGL060	AGL125	AGL250	AGL400	AGL600	AGL1000
ARM-Enabled IGLOO Devices ²					M1AGL250		M1AGL600	M1AGL1000
System Gates	15,000	30,000	60,000	125,000	250,000	400,000	600,000	1,000,000
Typical Equivalent Macrocells	128	256	512	1,024	2,048	—	—	—
VersaTiles (D-flip-flops)	384	768	1,536	3,072	6,144	9,216	13,824	24,576
Flash*Freeze Mode (typical, μ W)	5	5	10	16	24	32	36	53
RAM kbits (1,024 bits)	—	—	18	36	36	54	108	144
4,608-Bit Blocks	—	—	4	8	8	12	24	32
FlashROM Kbits (1,024 bits)	1	1	1	1	1	1	1	1
AES-Protected ISP ²	—	—	Yes	Yes	Yes	Yes	Yes	Yes
Integrated PLL in CCCs ³	—	—	1	1	1	1	1	1
VersaNet Globals ⁴	6	6	18	18	18	18	18	18
I/O Banks	2	2	2	2	4	4	4	4
Maximum User I/Os	49	81	96	133	143	194	235	300
Package Pins								
UC/CS		UC81, CS81	CS121 ³	CS196	CS196 ⁵	CS196	CS281	CS281
QFN	QN68	QN48, QN68, QN132 ⁶	QN132 ⁶	QN132 ⁶	QN132 ⁶			
VQFP		VQ100	VQ100	VQ100	VQ100			
FBGA				FG144	FG144	FG144, FG256, FG484	FG144, FG256, FG484	FG144, FG256, FG484

Notes:

1. AGL015 is not recommended for new designs
2. AES is not available for ARM-enabled IGLOO devices.
3. AGL060 in CS121 does not support the PLL.
4. Six chip (main) and twelve quadrant global networks are available for AGL060 and above.
5. The M1AGL250 device does not support this package.
6. Package not available.
7. The IGLOOe datasheet and IGLOOe FPGA Fabric User Guide provide information on higher densities and additional features.

[†] AGL015 and AGL030 devices do not support this feature.

[‡] Supported only by AGL015 and AGL030 devices.

I/Os Per Package¹

IGLOO Devices	AGL015 ²	AGL030	AGL060	AGL125	AGL250	AGL400	AGL600	AGL1000				
ARM-Enabled IGLOO Devices					M1AGL250		M1AGL600	M1AGL1000				
Package	I/O Type ³											
	Single-Ended I/O	Single-Ended I/O	Single-Ended I/O	Single-Ended I/O	Single-Ended I/O ⁴	Differential I/O Pairs	Single-Ended I/O ⁴	Differential I/O Pairs	Single-Ended I/O ⁴	Differential I/O Pairs	Single-Ended I/O ⁴	Differential I/O Pairs
QN48	-	34	-	-	-	-	-	-	-	-	-	-
QN68	49	49	-	-	-	-	-	-	-	-	-	-
UC81	-	66	-	-	-	-	-	-	-	-	-	-
CS81	-	66	-	-	-	-	-	-	-	-	-	-
CS121	-	-	96	96	-	-	-	-	-	-	-	-
VQ100	-	77	71	71	68	13	-	-	-	-	-	-
QN132 ⁶	-	81	80	84	-	-	-	-	-	-	-	-
CS196	-	-	-	133	143 ⁵	35 ⁵	143	35	-	-	-	-
FG144	-	-	-	97	97	24	97	25	97	25	97	25
FG256 ⁷	-	-	-	-	-	-	178	38	177	43	177	44
CS281	-	-	-	-	-	-	-	-	215	53	215	53
FG484 ⁷	-	-	-	-	-	-	194	38	235	60	300	74

Notes:

- When considering migrating your design to a lower- or higher-density device, refer to the IGLOO FPGA Fabric User Guide to ensure compliance with design and board migration requirements.
- AGL015 is not recommended for new designs.
- When the Flash*Freeze pin is used to directly enable Flash*Freeze mode and not used as a regular I/O, the number of single-ended user I/Os available is reduced by one.
- Each used differential I/O pair reduces the number of single-ended I/Os available by two.
- The M1AGL250 device does not support QN132 or CS196 packages.
- Package not available.
- FG256 and FG484 are footprint-compatible packages.

Table 1 • IGLOO FPGAs Package Sizes Dimensions

Package	UC81	CS81	CS121	QN48	QN68	QN132*	CS196	CS281	FG144	VQ100	FG256	FG484
Length x Width (mm\mm)	4 x 4	5 x 5	6 x 6	6 x 6	8 x 8	8 x 8	8 x 8	10 x 10	13 x 13	14 x 14	17 x 17	23 x 23
Nominal Area (mm ²)	16	25	36	36	64	64	64	100	169	196	289	529
Pitch (mm)	0.4	0.5	0.5	0.4	0.4	0.5	0.5	0.5	1.0	0.5	1.0	1.0
Height (mm)	0.80	0.80	0.99	0.90	0.90	0.75	1.20	1.05	1.45	1.00	1.60	2.23

Note: * Package not available.

IGLOO Ordering Information

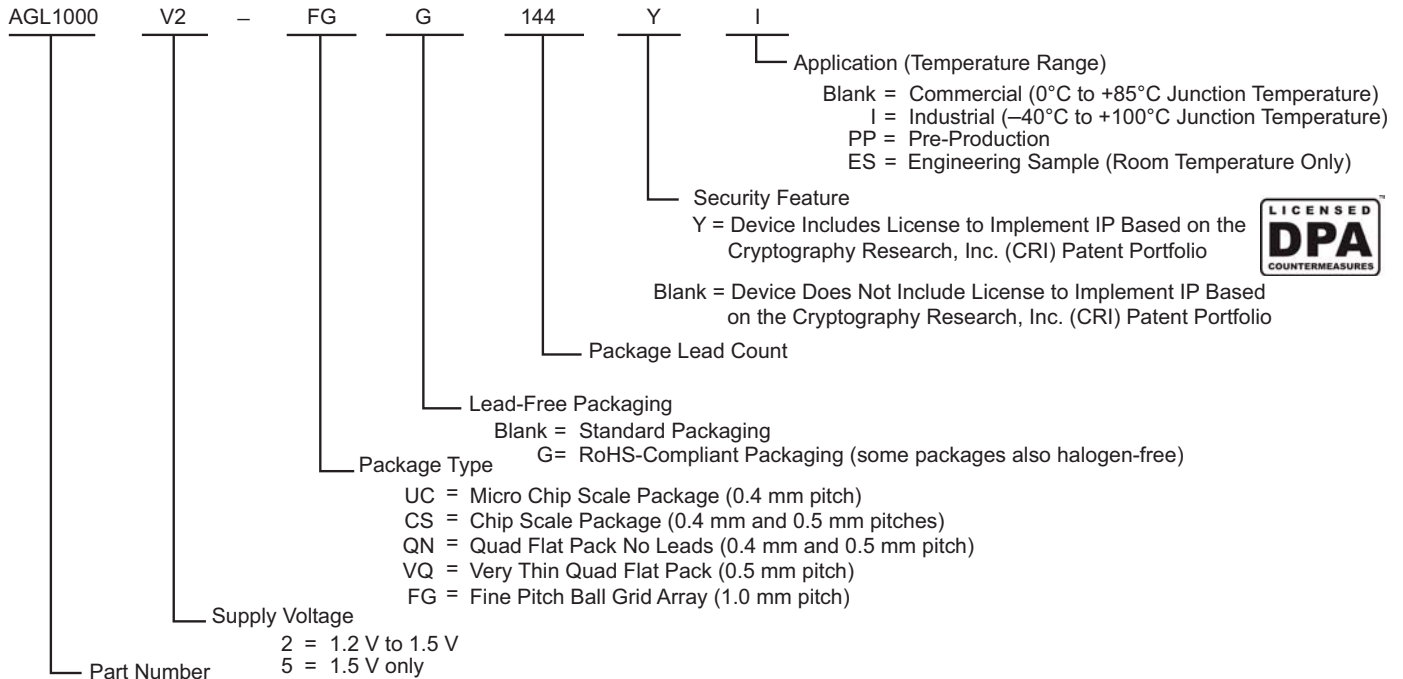

IGLOO Devices

AGL015 = 15,000 System Gates
 AGL030 = 30,000 System Gates
 AGL060 = 60,000 System Gates
 AGL125 = 125,000 System Gates
 AGL250 = 250,000 System Gates
 AGL400 = 400,000 System Gates
 AGL600 = 600,000 System Gates
 AGL1000 = 1,000,000 System Gates

IGLOO Devices with Cortex-M1

M1AGL250 = 250,000 System Gates
 M1AGL600 = 600,000 System Gates
 M1AGL1000 = 1,000,000 System Gates

Note: Marking Information: IGLOO V2 devices do not have V2 marking, but IGLOO V5 devices are marked accordingly.

Temperature Grade Offerings

Package	AGL015 ¹	AGL030	AGL060	AGL125	AGL250	AGL400	AGL600	AGL1000
					M1AGL250		M1AGL600	M1AGL1000
QN48	–	C, I	–	–	–	–	–	–
QN68	C, I	–	–	–	–	–	–	–
UC81	–	C, I	–	–	–	–	–	–
CS81	–	C, I	–	–	–	–	–	–
CS121	–	–	C, I	C, I	–	–	–	–
VQ100	–	C, I	C, I	C, I	C, I	–	–	–
QN132 ²	–	C, I	C, I ²	C, I	–	–	–	–
CS196	–	–	–	C, I	C, I	C, I	–	–
FG144	–	–	–	C, I	C, I	C, I	C, I	C, I
FG256	–	–	–	–	–	C, I	C, I	C, I
CS281	–	–	–	–	–	–	C, I	C, I
FG484	–	–	–	–	–	C, I	C, I	C, I

Notes:

1. AGL015 is not recommended for new designs.
 2. Package not available.
- C = Commercial temperature range: 0°C to 85°C junction temperature.
 I = Industrial temperature range: –40°C to 100°C junction temperature.

IGLOO Device Status

IGLOO Devices	Status	M1 IGLOO Devices	Status
AGL015	Not recommended for new designs.		
AGL030	Production		
AGL060	Production		
AGL125	Production		
AGL250	Production	M1AGL250	Production
AGL400	Production		
AGL600	Production	M1AGL600	Production
AGL1000	Production	M1AGL1000	Production

References made to IGLOO devices also apply to ARM-enabled IGLOOe devices. The ARM-enabled part numbers start with M1 (Cortex-M1).

Contact your local Microsemi SoC Products Group representative for device availability:
www.microsemi.com/soc/contact/default.aspx.

AGL015 and AGL030

The AGL015 and AGL030 are architecturally compatible; there are no RAM or PLL features.

Devices Not Recommended For New Designs

AGL015 is not recommended for new designs.

IGLOO Device Family Overview

General Description	1-1
---------------------------	-----

IGLOO DC and Switching Characteristics

General Specifications	2-1
Calculating Power Dissipation	2-7
Power Calculation Methodology	2-17
User I/O Characteristics	2-20
VersaTile Characteristics	2-100
Global Resource Characteristics	2-106
Clock Conditioning Circuits	2-115
Embedded SRAM and FIFO Characteristics	2-118
Embedded FlashROM Characteristics	2-132
JTAG 1532 Characteristics	2-133

Pin Descriptions

Supply Pins	3-1
User Pins	3-2
JTAG Pins	3-4
Special Function Pins	3-5
Packaging	3-5
Related Documents	3-5

Package Pin Assignments

UC81	4-1
CS81	4-3
CS121	4-6
CS196	4-9
CS281	4-16
QN48	4-23
QN68	4-25
QN132	4-28
VQ100	4-37
FG144	4-42
FG256	4-53
FG484	4-63

Datasheet Information

List of Changes	5-1
Datasheet Categories	5-13
Safety Critical, Life Support, and High-Reliability Applications Policy	5-13

1 – IGLOO Device Family Overview

General Description

The IGLOO family of flash FPGAs, based on a 130-nm flash process, offers the lowest power FPGA, a single-chip solution, small footprint packages, reprogrammability, and an abundance of advanced features.

The Flash*Freeze technology used in IGLOO devices enables entering and exiting an ultra-low power mode that consumes as little as 5 μ W while retaining SRAM and register data. Flash*Freeze technology simplifies power management through I/O and clock management with rapid recovery to operation mode.

The Low Power Active capability (static idle) allows for ultra-low power consumption (from 12 μ W) while the IGLOO device is completely functional in the system. This allows the IGLOO device to control system power management based on external inputs (e.g., scanning for keyboard stimulus) while consuming minimal power.

Nonvolatile flash technology gives IGLOO devices the advantage of being a secure, low power, single-chip solution that is Instant On. IGLOO is reprogrammable and offers time-to-market benefits at an ASIC-level unit cost.

These features enable designers to create high-density systems using existing ASIC or FPGA design flows and tools.

IGLOO devices offer 1 kbit of on-chip, reprogrammable, nonvolatile FlashROM storage as well as clock conditioning circuitry based on an integrated phase-locked loop (PLL). The AGL015 and AGL030 devices have no PLL or RAM support. IGLOO devices have up to 1 million system gates, supported with up to 144 kbits of true dual-port SRAM and up to 300 user I/Os.

M1 IGLOO devices support the high-performance, 32-bit Cortex-M1 processor developed by ARM for implementation in FPGAs. Cortex-M1 is a soft processor that is fully implemented in the FPGA fabric. It has a three-stage pipeline that offers a good balance between low power consumption and speed when implemented in an M1 IGLOO device. The processor runs the ARMv6-M instruction set, has a configurable nested interrupt controller, and can be implemented with or without the debug block. Cortex-M1 is available for free from Microsemi for use in M1 IGLOO FPGAs.

The ARM-enabled devices have ordering numbers that begin with M1AGL and do not support AES decryption.

Flash*Freeze Technology

The IGLOO device offers unique Flash*Freeze technology, allowing the device to enter and exit ultra-low power Flash*Freeze mode. IGLOO devices do not need additional components to turn off I/Os or clocks while retaining the design information, SRAM content, and registers. Flash*Freeze technology is combined with in-system programmability, which enables users to quickly and easily upgrade and update their designs in the final stages of manufacturing or in the field. The ability of IGLOO V2 devices to support a wide range of core voltage (1.2 V to 1.5 V) allows further reduction in power consumption, thus achieving the lowest total system power.

When the IGLOO device enters Flash*Freeze mode, the device automatically shuts off the clocks and inputs to the FPGA core; when the device exits Flash*Freeze mode, all activity resumes and data is retained.

The availability of low power modes, combined with reprogrammability, a single-chip and single-voltage solution, and availability of small-footprint, high pin-count packages, make IGLOO devices the best fit for portable electronics.

Flash Advantages

Low Power

Flash-based IGLOO devices exhibit power characteristics similar to those of an ASIC, making them an ideal choice for power-sensitive applications. IGLOO devices have only a very limited power-on current surge and no high-current transition period, both of which occur on many FPGAs.

IGLOO devices also have low dynamic power consumption to further maximize power savings; power is even further reduced by the use of a 1.2 V core voltage.

Low dynamic power consumption, combined with low static power consumption and Flash*Freeze technology, gives the IGLOO device the lowest total system power offered by any FPGA.

Security

Nonvolatile, flash-based IGLOO devices do not require a boot PROM, so there is no vulnerable external bitstream that can be easily copied. IGLOO devices incorporate FlashLock, which provides a unique combination of reprogrammability and design security without external overhead, advantages that only an FPGA with nonvolatile flash programming can offer.

IGLOO devices utilize a 128-bit flash-based lock and a separate AES key to provide the highest level of protection in the FPGA industry for intellectual property and configuration data. In addition, all FlashROM data in IGLOO devices can be encrypted prior to loading, using the industry-leading AES-128 (FIPS192) bit block cipher encryption standard. AES was adopted by the National Institute of Standards and Technology (NIST) in 2000 and replaces the 1977 DES standard. IGLOO devices have a built-in AES decryption engine and a flash-based AES key that make them the most comprehensive programmable logic device security solution available today. IGLOO devices with AES-based security provide a high level of protection for remote field updates over public networks such as the Internet, and are designed to ensure that valuable IP remains out of the hands of system overbuilders, system cloners, and IP thieves.

Security, built into the FPGA fabric, is an inherent component of the IGLOO family. The flash cells are located beneath seven metal layers, and many device design and layout techniques have been used to make invasive attacks extremely difficult. The IGLOO family, with FlashLock and AES security, is unique in being highly resistant to both invasive and noninvasive attacks. Your valuable IP is protected with industry-standard security, making remote ISP possible. An IGLOO device provides the best available security for programmable logic designs.

Single Chip

Flash-based FPGAs store their configuration information in on-chip flash cells. Once programmed, the configuration data is an inherent part of the FPGA structure, and no external configuration data needs to be loaded at system power-up (unlike SRAM-based FPGAs). Therefore, flash-based IGLOO FPGAs do not require system configuration components such as EEPROMs or microcontrollers to load device configuration data. This reduces bill-of-materials costs and PCB area, and increases security and system reliability.

Instant On

Flash-based IGLOO devices support Level 0 of the Instant On classification standard. This feature helps in system component initialization, execution of critical tasks before the processor wakes up, setup and configuration of memory blocks, clock generation, and bus activity management. The Instant On feature of flash-based IGLOO devices greatly simplifies total system design and reduces total system cost, often eliminating the need for CPLDs and clock generation PLLs. In addition, glitches and brownouts in system power will not corrupt the IGLOO device's flash configuration, and unlike SRAM-based FPGAs, the device will not have to be reloaded when system power is restored. This enables the reduction or complete removal of the configuration PROM, expensive voltage monitor, brownout detection, and clock generator devices from the PCB design. Flash-based IGLOO devices simplify total system design and reduce cost and design risk while increasing system reliability and improving system initialization time.

IGLOO flash FPGAs allow the user to quickly enter and exit Flash*Freeze mode. This is done almost instantly (within 1 μ s) and the device retains configuration and data in registers and RAM. Unlike SRAM-based FPGAs the device does not need to reload configuration and design state from external memory components; instead it retains all necessary information to resume operation immediately.

Reduced Cost of Ownership

Advantages to the designer extend beyond low unit cost, performance, and ease of use. Unlike SRAM-based FPGAs, Flash-based IGLOO devices allow all functionality to be Instant On; no external boot PROM is required. On-board security mechanisms prevent access to all the programming information and enable secure remote updates of the FPGA logic. Designers can perform secure remote in-system reprogramming to support future design iterations and

field upgrades with confidence that valuable intellectual property cannot be compromised or copied. Secure ISP can be performed using the industry-standard AES algorithm. The IGLOO family device architecture mitigates the need for ASIC migration at higher user volumes. This makes the IGLOO family a cost-effective ASIC replacement solution, especially for applications in the consumer, networking/communications, computing, and avionics markets.

Firm-Error Immunity

Firm errors occur most commonly when high-energy neutrons, generated in the upper atmosphere, strike a configuration cell of an SRAM FPGA. The energy of the collision can change the state of the configuration cell and thus change the logic, routing, or I/O behavior in an unpredictable way. These errors are impossible to prevent in SRAM FPGAs. The consequence of this type of error can be a complete system failure. Firm errors do not exist in the configuration memory of IGLOO flash-based FPGAs. Once it is programmed, the flash cell configuration element of IGLOO FPGAs cannot be altered by high-energy neutrons and is therefore immune to them. Recoverable (or soft) errors occur in the user data SRAM of all FPGA devices. These can easily be mitigated by using error detection and correction (EDAC) circuitry built into the FPGA fabric.

Advanced Flash Technology

The IGLOO family offers many benefits, including nonvolatility and reprogrammability, through an advanced flash-based, 130-nm LVCMOS process with seven layers of metal. Standard CMOS design techniques are used to implement logic and control functions. The combination of fine granularity, enhanced flexible routing resources, and abundant flash switches allows for very high logic utilization without compromising device routability or performance. Logic functions within the device are interconnected through a four-level routing hierarchy.

IGLOO family FPGAs utilize design and process techniques to minimize power consumption in all modes of operation.

Advanced Architecture

The proprietary IGLOO architecture provides granularity comparable to standard-cell ASICs. The IGLOO device consists of five distinct and programmable architectural features (Figure 1-1 on page 1-4 and Figure 1-2 on page 1-4):

- Flash*Freeze technology
- FPGA VersaTiles
- Dedicated FlashROM
- Dedicated SRAM/FIFO memory[†]
- Extensive CCCs and PLLs[†]
- Advanced I/O structure

The FPGA core consists of a sea of VersaTiles. Each VersaTile can be configured as a three-input logic function, a D-flip-flop (with or without enable), or a latch by programming the appropriate flash switch interconnections. The versatility of the IGLOO core tile as either a three-input lookup table (LUT) equivalent or a D-flip-flop/latch with enable allows for efficient use of the FPGA fabric. The VersaTile capability is unique to the ProASIC[®] family of third-generation-architecture flash FPGAs.

[†] The AGL015 and AGL030 do not support PLL or SRAM.

VersaTiles are connected with any of the four levels of routing hierarchy. Flash switches are distributed throughout the device to provide nonvolatile, reconfigurable interconnect programming. Maximum core utilization is possible for virtually any design.

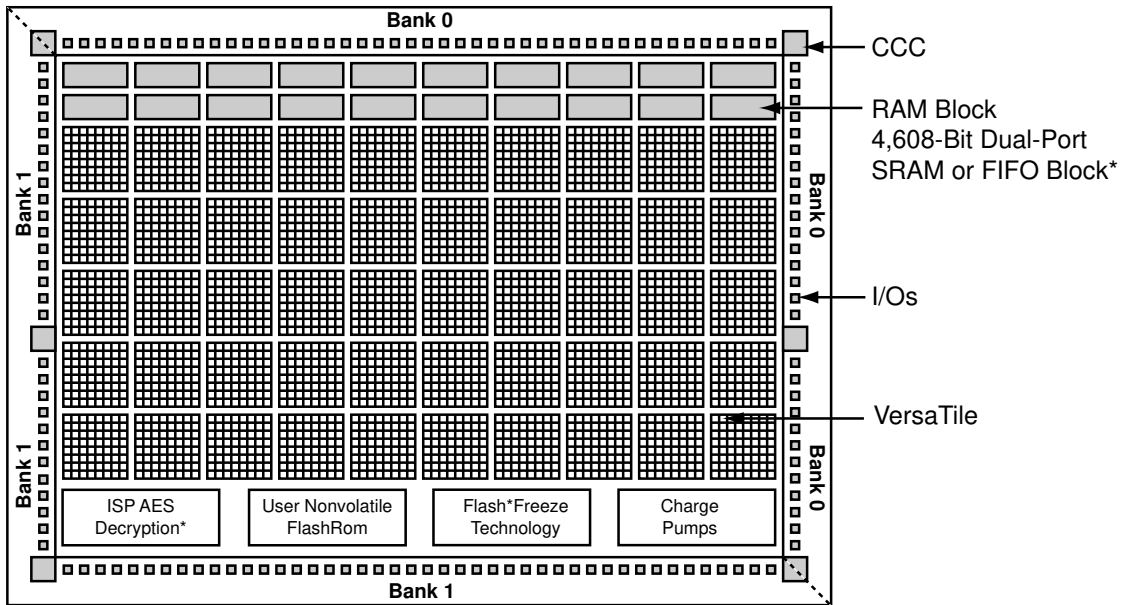

Note: *Not supported by AGL015 and AGL030 devices

Figure 1-1 • IGLOO Device Architecture Overview with Two I/O Banks (AGL015, AGL030, AGL060, and AGL125)

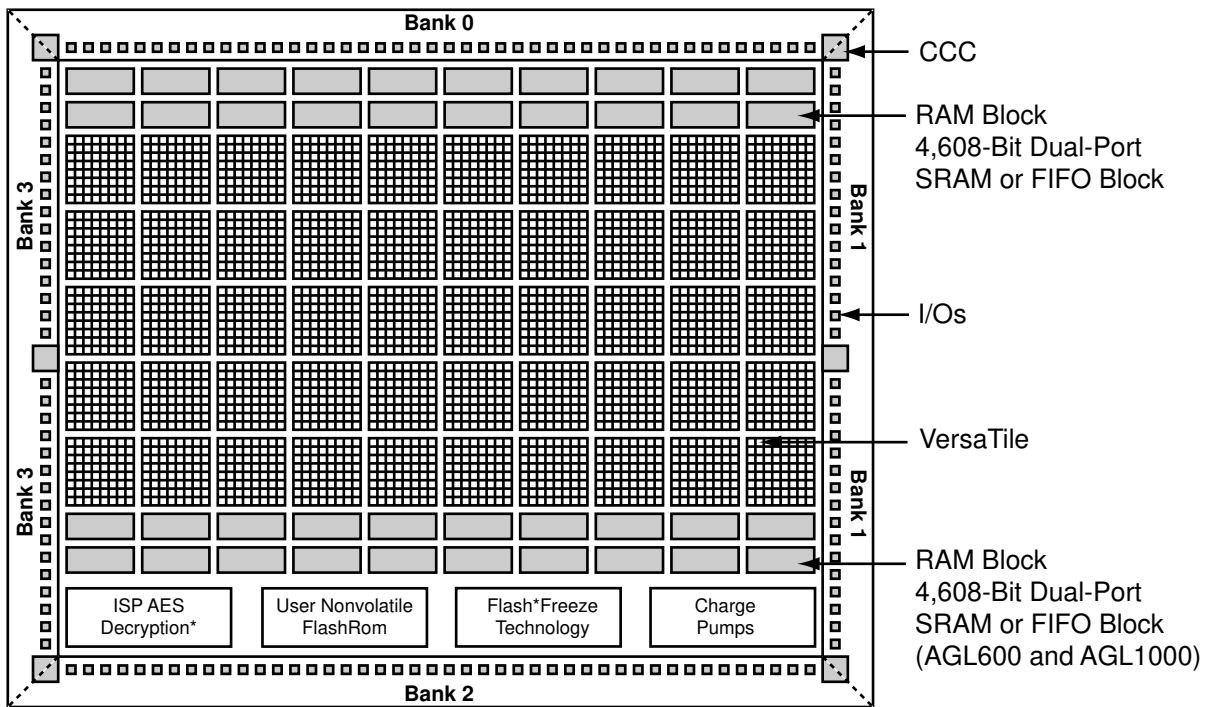

Figure 1-2 • IGLOO Device Architecture Overview with Four I/O Banks (AGL250, AGL600, AGL400, and AGL1000)

Flash*Freeze Technology

The IGLOO device has an ultra-low power static mode, called Flash*Freeze mode, which retains all SRAM and register information and can still quickly return to normal operation. Flash*Freeze technology enables the user to quickly (within 1 μ s) enter and exit Flash*Freeze mode by activating the Flash*Freeze pin while all power supplies are kept at their original values. In addition, I/Os and global I/Os can still be driven and can be toggling without impact on power consumption, clocks can still be driven or can be toggling without impact on power consumption, and the device retains all core registers, SRAM information, and states. I/O states are tristated during Flash*Freeze mode or can be set to a certain state using weak pull-up or pull-down I/O attribute configuration. No power is consumed by the I/O banks, clocks, JTAG pins, or PLL, and the device consumes as little as 5 μ W in this mode.

Flash*Freeze technology allows the user to switch to active mode on demand, thus simplifying the power management of the device.

The Flash*Freeze pin (active low) can be routed internally to the core to allow the user's logic to decide when it is safe to transition to this mode. It is also possible to use the Flash*Freeze pin as a regular I/O if Flash*Freeze mode usage is not planned, which is advantageous because of the inherent low power static (as low as 12 μ W) and dynamic capabilities of the IGLOO device. Refer to Figure 1-3 for an illustration of entering/exiting Flash*Freeze mode.

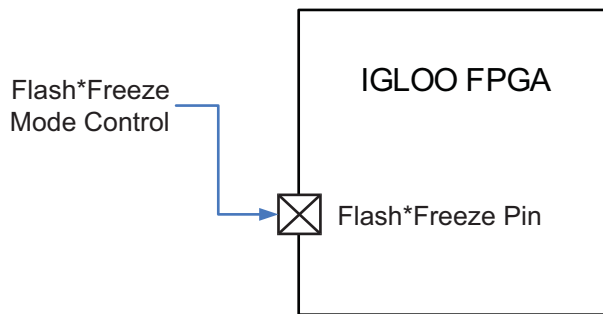

Figure 1-3 • IGLOO Flash*Freeze Mode

VersaTiles

The IGLOO core consists of VersaTiles, which have been enhanced beyond the ProASIC^{PLUS}® core tiles. The IGLOO VersaTile supports the following:

- All 3-input logic functions—LUT-3 equivalent
- Latch with clear or set
- D-flip-flop with clear or set
- Enable D-flip-flop with clear or set

Refer to Figure 1-4 for VersaTile configurations.

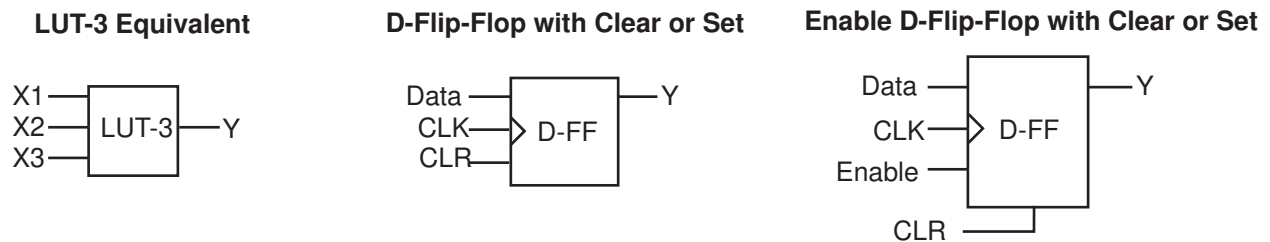

Figure 1-4 • VersaTile Configurations

User Nonvolatile FlashROM

IGLOO devices have 1 kbit of on-chip, user-accessible, nonvolatile FlashROM. The FlashROM can be used in diverse system applications:

- Internet protocol addressing (wireless or fixed)
- System calibration settings
- Device serialization and/or inventory control
- Subscription-based business models (for example, set-top boxes)
- Secure key storage for secure communications algorithms
- Asset management/tracking
- Date stamping
- Version management

The FlashROM is written using the standard IGLOO IEEE 1532 JTAG programming interface. The core can be individually programmed (erased and written), and on-chip AES decryption can be used selectively to securely load data over public networks (except in the AGL015 and AGL030 devices), as in security keys stored in the FlashROM for a user design.

The FlashROM can be programmed via the JTAG programming interface, and its contents can be read back either through the JTAG programming interface or via direct FPGA core addressing. Note that the FlashROM can only be programmed from the JTAG interface and cannot be programmed from the internal logic array.

The FlashROM is programmed as 8 banks of 128 bits; however, reading is performed on a byte-by-byte basis using a synchronous interface. A 7-bit address from the FPGA core defines which of the 8 banks and which of the 16 bytes within that bank are being read. The three most significant bits (MSBs) of the FlashROM address determine the bank, and the four least significant bits (LSBs) of the FlashROM address define the byte.

The Microsemi development software solutions, Libero® System-on-Chip (SoC) and Designer, have extensive support for the FlashROM. One such feature is auto-generation of sequential programming files for applications requiring a unique serial number in each part. Another feature allows the inclusion of static data for system version control. Data for the FlashROM can be generated quickly and easily using Libero SoC and Designer software tools. Comprehensive programming file support is also included to allow for easy programming of large numbers of parts with differing FlashROM contents.

SRAM and FIFO

IGLOO devices (except the AGL015 and AGL030 devices) have embedded SRAM blocks along their north and south sides. Each variable-aspect-ratio SRAM block is 4,608 bits in size. Available memory configurations are 256×18, 512×9, 1k×4, 2k×2, and 4k×1 bits. The individual blocks have independent read and write ports that can be configured with different bit widths on each port. For example, data can be sent through a 4-bit port and read as a single bitstream. The embedded SRAM blocks can be initialized via the device JTAG port (ROM emulation mode) using the UJTAG macro (except in the AGL015 and AGL030 devices).

In addition, every SRAM block has an embedded FIFO control unit. The control unit allows the SRAM block to be configured as a synchronous FIFO without using additional core VersaTiles. The FIFO width and depth are programmable. The FIFO also features programmable Almost Empty (AEMPTY) and Almost Full (AFULL) flags in addition to the normal Empty and Full flags. The embedded FIFO control unit contains the counters necessary for generation of the read and write address pointers. The embedded SRAM/FIFO blocks can be cascaded to create larger configurations.

PLL and CCC

IGLOO devices provide designers with very flexible clock conditioning circuit (CCC) capabilities. Each member of the IGLOO family contains six CCCs. One CCC (center west side) has a PLL. The AGL015 and AGL030 do not have a PLL.

The six CCC blocks are located at the four corners and the centers of the east and west sides. One CCC (center west side) has a PLL.

All six CCC blocks are usable; the four corner CCCs and the east CCC allow simple clock delay operations as well as clock spine access.

The inputs of the six CCC blocks are accessible from the FPGA core or from one of several inputs located near the CCC that have dedicated connections to the CCC block.

The CCC block has these key features:

- Wide input frequency range (f_{IN_CCC}) = 1.5 MHz up to 250 MHz
- Output frequency range (f_{OUT_CCC}) = 0.75 MHz up to 250 MHz
- 2 programmable delay types for clock skew minimization
- Clock frequency synthesis (for PLL only)

Additional CCC specifications:

- Internal phase shift = 0°, 90°, 180°, and 270°. Output phase shift depends on the output divider configuration (for PLL only).
- Output duty cycle = 50% ± 1.5% or better (for PLL only)
- Low output jitter: worst case < 2.5% × clock period peak-to-peak period jitter when single global network used (for PLL only)
- Maximum acquisition time is 300 μs (for PLL only)
- Exceptional tolerance to input period jitter—allowable input jitter is up to 1.5 ns (for PLL only)
- Four precise phases; maximum misalignment between adjacent phases of 40 ps × 250 MHz / f_{OUT_CCC} (for PLL only)

Global Clocking

IGLOO devices have extensive support for multiple clocking domains. In addition to the CCC and PLL support described above, there is a comprehensive global clock distribution network.

Each VersaTile input and output port has access to nine VersaNets: six chip (main) and three quadrant global networks. The VersaNets can be driven by the CCC or directly accessed from the core via multiplexers (MUXes). The VersaNets can be used to distribute low-skew clock signals or for rapid distribution of high-fanout nets.

I/Os with Advanced I/O Standards

The IGLOO family of FPGAs features a flexible I/O structure, supporting a range of voltages (1.2 V, 1.5 V, 1.8 V, 2.5 V, 3.0 V wide range, and 3.3 V). IGLOO FPGAs support many different I/O standards—single-ended and differential.

The I/Os are organized into banks, with two or four banks per device. The configuration of these banks determines the I/O standards supported (Table 1-1).

Table 1-1 • I/O Standards Supported

I/O Bank Type	Device and Bank Location	I/O Standards Supported		
		LVTTL/LVCMOS	PCI/PCI-X	LVPECL, LVDS, B-LVDS, M-LVDS
Advanced	East and west banks of AGL250 and larger devices	✓	✓	✓
Standard Plus	North and south banks of AGL250 and larger devices All banks of AGL060 and AGL125K	✓	✓	Not supported
Standard	All banks of AGL015 and AGL030	✓	Not supported	Not supported

Each I/O module contains several input, output, and enable registers. These registers allow the implementation of the following:

- Single-Data-Rate applications
- Double-Data-Rate applications—DDR LVDS, B-LVDS, and M-LVDS I/Os for point-to-point communications

IGLOO banks for the AGL250 device and above support LVPECL, LVDS, B-LVDS, and M-LVDS. B-LVDS and M-LVDS can support up to 20 loads.

Hot-swap (also called hot-plug, or hot-insertion) is the operation of hot-insertion or hot-removal of a card in a powered-up system.

Cold-sparing (also called cold-swap) refers to the ability of a device to leave system data undisturbed when the system is powered up, while the component itself is powered down, or when power supplies are floating.

Wide Range I/O Support

IGLOO devices support JEDEC-defined wide range I/O operation. IGLOO devices support both the JESD8-B specification, covering 3 V and 3.3 V supplies, for an effective operating range of 2.7 V to 3.6 V, and JESD8-12 with its 1.2 V nominal, supporting an effective operating range of 1.14 V to 1.575 V.

Wider I/O range means designers can eliminate power supplies or power conditioning components from the board or move to less costly components with greater tolerances. Wide range eases I/O bank management and provides enhanced protection from system voltage spikes, while providing the flexibility to easily run custom voltage applications.

Specifying I/O States During Programming

You can modify the I/O states during programming in FlashPro. In FlashPro, this feature is supported for PDB files generated from Designer v8.5 or greater. See the [FlashPro User Guide](#) for more information.

Note: PDB files generated from Designer v8.1 to Designer v8.4 (including all service packs) have limited display of Pin Numbers only.

1. Load a PDB from the FlashPro GUI. You must have a PDB loaded to modify the I/O states during programming.
2. From the FlashPro GUI, click PDB Configuration. A FlashPoint – Programming File Generator window appears.
3. Click the Specify I/O States During Programming button to display the Specify I/O States During Programming dialog box.
4. Sort the pins as desired by clicking any of the column headers to sort the entries by that header. Select the I/Os you wish to modify ([Figure 1-5 on page 1-9](#)).
5. Set the I/O Output State. You can set Basic I/O settings if you want to use the default I/O settings for your pins, or use Custom I/O settings to customize the settings for each pin. Basic I/O state settings:
 - 1 – I/O is set to drive out logic High
 - 0 – I/O is set to drive out logic Low
 - Last Known State – I/O is set to the last value that was driven out prior to entering the programming mode, and then held at that value during programming
 - Z -Tri-State: I/O is tristated

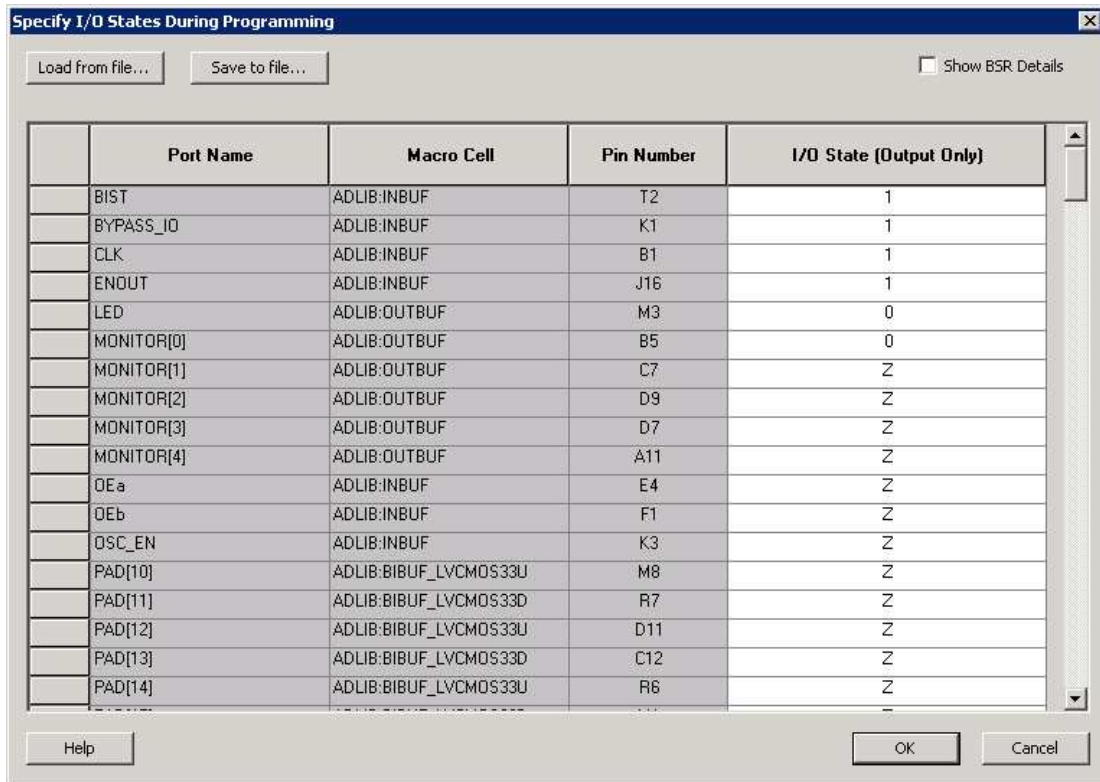

Figure 1-5 • I/O States During Programming Window

6. Click OK to return to the FlashPoint – Programming File Generator window.

Note: I/O States During programming are saved to the ADB and resulting programming files after completing programming file generation.

2 – IGLOO DC and Switching Characteristics

General Specifications

Operating Conditions

Stresses beyond those listed in [Table 2-1](#) may cause permanent damage to the device.

Exposure to absolute maximum rating conditions for extended periods may affect device reliability. Absolute Maximum Ratings are stress ratings only; functional operation of the device at these or any other conditions beyond those listed under the Recommended Operating Conditions specified in [Table 2-2](#) on [page 2-2](#) is not implied.

Table 2-1 • Absolute Maximum Ratings

Symbol	Parameter	Limits ¹	Units
VCC	DC core supply voltage	-0.3 to 1.65	V
VJTAG	JTAG DC voltage	-0.3 to 3.75	V
VPUMP	Programming voltage	-0.3 to 3.75	V
VCCPLL	Analog power supply (PLL)	-0.3 to 1.65	V
VCCI and VMV ²	DC I/O buffer supply voltage	-0.3 to 3.75	V
VI	I/O input voltage	-0.3 V to 3.6 V (when I/O hot insertion mode is enabled) -0.3 V to (VCCI + 1 V) or 3.6 V, whichever voltage is lower (when I/O hot-insertion mode is disabled)	V
T _{STG} ³	Storage Temperature	-65 to +150	°C
T _J ³	Junction Temperature	+125	°C

Notes:

1. The device should be operated within the limits specified by the datasheet. During transitions, the input signal may undershoot or overshoot according to the limits shown in [Table 2-4](#) on [page 2-3](#).
2. VMV pins must be connected to the corresponding VCCI pins. See the "Pin Descriptions" chapter of the [IGLOO FPGA Fabric User Guide](#) for further information.
3. For flash programming and retention, maximum limits refer to [Table 2-3](#) on [page 2-3](#), and for recommended operating limits, refer to [Table 2-2](#) on [page 2-2](#).

Table 2-2 • Recommended Operating Conditions¹

Symbol	Parameter		Commercial	Industrial	Units
T _J	Junction Temperature ²		0 to +85	-40 to +100	°C
VCC ³	1.5 V DC core supply voltage ⁵		1.425 to 1.575	1.425 to 1.575	V
	1.2 V–1.5 V wide range DC core supply voltage ^{4,6}		1.14 to 1.575	1.14 to 1.575	V
VJTAG	JTAG DC voltage		1.4 to 3.6	1.4 to 3.6	V
VPUMP	Programming voltage	Programming Mode	3.15 to 3.45	3.15 to 3.45	V
		Operation ⁷	0 to 3.6	0 to 3.6	V
VCCPLL ⁸	Analog power supply (PLL)	1.5 V DC core supply voltage ⁵	1.425 to 1.575	1.425 to 1.575	V
		1.2 V – 1.5 V DC core supply voltage ^{4,6}	1.14 to 1.575	1.14 to 1.575	V
VCCI and VMV ⁹	1.2 V DC core supply voltage ⁶		1.14 to 1.26	1.14 to 1.26	V
	1.2 V DC wide range DC supply voltage ⁶		1.14 to 1.575	1.14 to 1.575	V
	1.5 V DC supply voltage		1.425 to 1.575	1.425 to 1.575	V
	1.8 V DC supply voltage		1.7 to 1.9	1.7 to 1.9	V
	2.5 V DC supply voltage		2.3 to 2.7	2.3 to 2.7	V
	3.0 V DC supply voltage ¹⁰		2.7 to 3.6	2.7 to 3.6	V
	3.3 V DC supply voltage		3.0 to 3.6	3.0 to 3.6	V
	LVDS differential I/O		2.375 to 2.625	2.375 to 2.625	V
LVPECL differential I/O		3.0 to 3.6	3.0 to 3.6	V	

Notes:

- All parameters representing voltages are measured with respect to GND unless otherwise specified.
- Software Default Junction Temperature Range in the Libero SoC software is set to 0°C to +70°C for commercial, and -40°C to +85°C for industrial. To ensure targeted reliability standards are met across the full range of junction temperatures, Microsemi recommends using custom settings for temperature range before running timing and power analysis tools. For more information on custom settings, refer to the New Project Dialog Box in the [Libero SoC Online Help](#).
- The ranges given here are for power supplies only. The recommended input voltage ranges specific to each I/O standard are given in [Table 2-25 on page 2-24](#). VCCI should be at the same voltage within a given I/O bank.
- All IGLOO devices (V5 and V2) must be programmed with the VCC core voltage at 1.5 V. Applications using the V2 devices powered by 1.2 V supply must switch the core supply to 1.5 V for in-system programming.
- For IGLOO[®] V5 devices
- For IGLOO V2 devices only, operating at VCCI ≥ VCC.
- VPUMP can be left floating during operation (not programming mode).
- VCCPLL pins should be tied to VCC pins. See the "Pin Descriptions" chapter of the [IGLOO FPGA Fabric User Guide](#) for further information.
- VMV and VCCI must be at the same voltage within a given I/O bank. VMV pins must be connected to the corresponding VCCI pins. See the "VMVx I/O Supply Voltage (quiet)" on [page 3-1](#) for further information.
- 3.3 V wide range is compliant to the JESD-8B specification and supports 3.0 V VCCI operation.

Table 2-3 • Flash Programming Limits – Retention, Storage, and Operating Temperature¹

Product Grade	Programming Cycles	Program Retention (biased/unbiased)	Maximum Storage Temperature T _{STG} (°C) ²	Maximum Operating Junction Temperature T _J (°C) ²
Commercial	500	20 years	110	100
Industrial	500	20 years	110	100

Notes:

1. This is a stress rating only; functional operation at any condition other than those indicated is not implied.
2. These limits apply for program/data retention only. Refer to Table 2-1 on page 2-1 and Table 2-2 on page 2-2 for device operating conditions and absolute limits.

Table 2-4 • Overshoot and Undershoot Limits¹

VCCI	Average VCCI–GND Overshoot or Undershoot Duration as a Percentage of Clock Cycle ²	Maximum Overshoot/Undershoot ²
2.7 V or less	10%	1.4 V
	5%	1.49 V
3 V	10%	1.1 V
	5%	1.19 V
3.3 V	10%	0.79 V
	5%	0.88 V
3.6 V	10%	0.45 V
	5%	0.54 V

Notes:

1. Based on reliability requirements at junction temperature at 85°C.
2. The duration is allowed at one out of six clock cycles. If the overshoot/undershoot occurs at one out of two cycles, the maximum overshoot/undershoot has to be reduced by 0.15 V.
3. This table does not provide PCI overshoot/undershoot limits.

I/O Power-Up and Supply Voltage Thresholds for Power-On Reset (Commercial and Industrial)

Sophisticated power-up management circuitry is designed into every IGLOO device. These circuits ensure easy transition from the powered-off state to the powered-up state of the device. The many different supplies can power up in any sequence with minimized current spikes or surges. In addition, the I/O will be in a known state through the power-up sequence. The basic principle is shown in Figure 2-1 on page 2-4 and Figure 2-2 on page 2-5.

There are five regions to consider during power-up.

IGLOO I/Os are activated only if ALL of the following three conditions are met:

1. VCC and VCCI are above the minimum specified trip points (Figure 2-1 on page 2-4 and Figure 2-2 on page 2-5).
2. VCCI > VCC – 0.75 V (typical)
3. Chip is in the operating mode.

VCCI Trip Point:

Ramping up (V5 devices): 0.6 V < trip_point_up < 1.2 V

Ramping down (V5 Devices): 0.5 V < trip_point_down < 1.1 V

Ramping up (V2 devices): 0.75 V < trip_point_up < 1.05 V

Ramping down (V2 devices): 0.65 V < trip_point_down < 0.95 V

VCC Trip Point:

Ramping up (V5 devices): 0.6 V < trip_point_up < 1.1 V

Ramping down (V5 devices): 0.5 V < trip_point_down < 1.0 V

Ramping up (V2 devices): $0.65\text{ V} < \text{trip_point_up} < 1.05\text{ V}$
 Ramping down (V2 devices): $0.55\text{ V} < \text{trip_point_down} < 0.95\text{ V}$

VCC and VCCI ramp-up trip points are about 100 mV higher than ramp-down trip points. This specifically built-in hysteresis prevents undesirable power-up oscillations and current surges. Note the following:

- During programming, I/Os become tristated and weakly pulled up to VCCI.
- JTAG supply, PLL power supplies, and charge pump VPUMP supply have no influence on I/O behavior.

PLL Behavior at Brownout Condition

Microsemi recommends using monotonic power supplies or voltage regulators to ensure proper power-up behavior. Power ramp-up should be monotonic at least until VCC and VCCPLX exceed brownout activation levels (see Figure 2-1 and Figure 2-2 on page 2-5 for more details).

When PLL power supply voltage and/or VCC levels drop below the VCC brownout levels ($0.75\text{ V} \pm 0.25\text{ V}$ for V5 devices, and $0.75\text{ V} \pm 0.2\text{ V}$ for V2 devices), the PLL output lock signal goes low and/or the output clock is lost. Refer to the Brownout Voltage section in the "Power-Up/Down Behavior of Low Power Flash Devices" chapter of the ProASIC[®]3 and ProASIC3E FPGA fabric user guides for information on clock and lock recovery.

Internal Power-Up Activation Sequence

1. Core
2. Input buffers
3. Output buffers, after 200 ns delay from input buffer activation

To make sure the transition from input buffers to output buffers is clean, ensure that there is no path longer than 100 ns from input buffer to output buffer in your design.

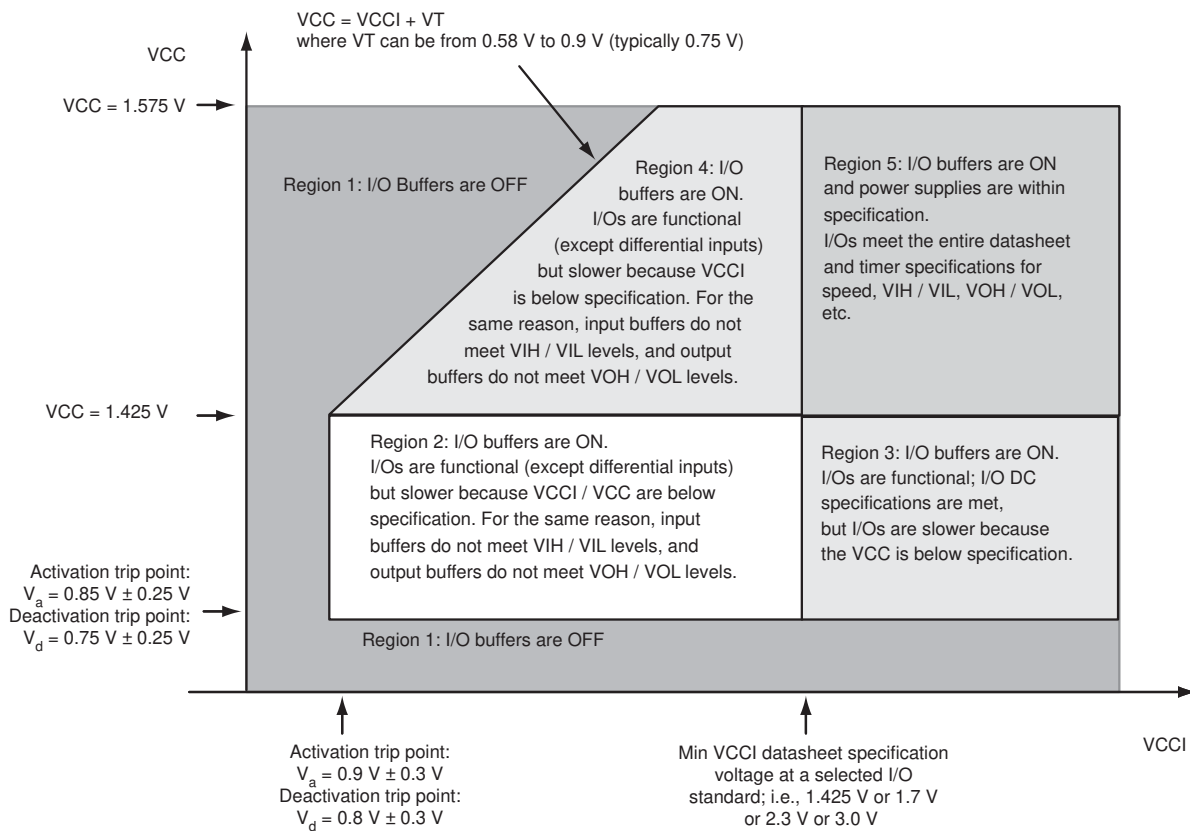

Figure 2-1 • V5 Devices – I/O State as a Function of VCCI and VCC Voltage Levels

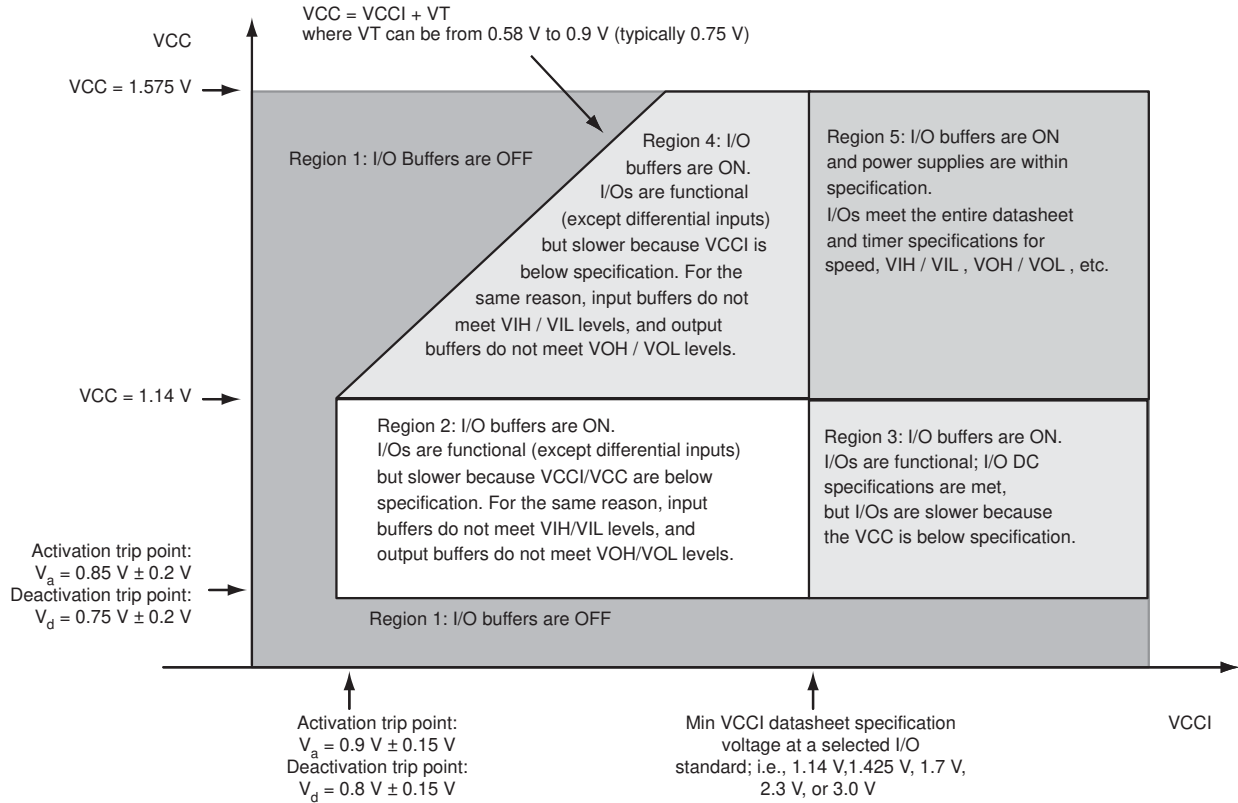

Figure 2-2 • V2 Devices – I/O State as a Function of VCCI and VCC Voltage Levels

Thermal Characteristics

Introduction

The temperature variable in the Designer software refers to the junction temperature, not the ambient temperature. This is an important distinction because dynamic and static power consumption cause the chip junction to be higher than the ambient temperature.

EQ 1 can be used to calculate junction temperature.

$$T_J = \text{Junction Temperature} = \Delta T + T_A$$

EQ 1

where:

T_A = Ambient Temperature

ΔT = Temperature gradient between junction (silicon) and ambient $\Delta T = \theta_{ja} * P$

θ_{ja} = Junction-to-ambient of the package. θ_{ja} numbers are located in Table 2-5 on page 2-6.

P = Power dissipation

Package Thermal Characteristics

The device junction-to-case thermal resistivity is θ_{jc} and the junction-to-ambient air thermal resistivity is θ_{ja} . The thermal characteristics for θ_{ja} are shown for two air flow rates. The absolute maximum junction temperature is 100°C. EQ 2 shows a sample calculation of the absolute maximum power dissipation allowed for the AGL1000-FG484 package at commercial temperature and in still air.

$$\text{Maximum Power Allowed} = \frac{\text{Max. junction temp. (}^\circ\text{C)} - \text{Max. ambient temp. (}^\circ\text{C)}}{\theta_{ja}(\text{}^\circ\text{C/W)}} = \frac{100^\circ\text{C} - 70^\circ\text{C}}{23.3^\circ\text{C/W}} = 1.28 \text{ W}$$

EQ 2

Table 2-5 • Package Thermal Resistivities

Package Type	Device	Pin Count	θ_{jc}	θ_{ja}			Unit
				Still Air	1 m/s	2.5 m/s	
Quad Flat No Lead (QN)	AGL030	132	13.1	21.4	16.8	15.3	C/W
	AGL060	132	11.0	21.2	16.6	15.0	C/W
	AGL125	132	9.2	21.1	16.5	14.9	C/W
	AGL250	132	8.9	21.0	16.4	14.8	C/W
	AGL030	68	13.4	68.4	45.8	43.1	C/W
Very Thin Quad Flat Pack (VQ)*		100	10.0	35.3	29.4	27.1	C/W
Chip Scale Package (CS)	AGL1000	281	6.0	28.0	22.8	21.5	C/W
	AGL400	196	7.2	37.1	31.1	28.9	C/W
	AGL250	196	7.6	38.3	32.2	30.0	C/W
	AGL125	196	8.0	39.5	33.4	31.1	C/W
	AGL030	81	12.4	32.8	28.5	27.2	C/W
	AGL060	81	11.1	28.8	24.8	23.5	C/W
	AGL250	81	10.4	26.9	22.3	20.9	C/W
Micro Chip Scale Package (UC)	AGL030	81	16.9	40.6	35.2	33.7	C/W
Fine Pitch Ball Grid Array (FG)	AGL060	144	18.6	55.2	49.4	47.2	C/W
	AGL1000	144	6.3	31.6	26.2	24.2	C/W
	AGL400	144	6.8	37.6	31.2	29.0	C/W
	AGL250	256	12.0	38.6	34.7	33.0	C/W
	AGL1000	256	6.6	28.1	24.4	22.7	C/W
	AGL1000	484	8.0	23.3	19.0	16.7	C/W

Note: *Thermal resistances for other device-package combinations will be posted in a later revision.

Disclaimer:

The simulation for determining the junction-to-air thermal resistance is based on JEDEC standards (JESD51) and assumptions made in building the model. Junction-to-case is based on SEMI G38-88. JESD51 is only used for comparing one package to another package, provided the two tests uses the same condition. They have little relevance in actual application and therefore should be used with a degree of caution.

Temperature and Voltage Derating Factors

**Table 2-6 • Temperature and Voltage Derating Factors for Timing Delays (normalized to $T_J = 70^\circ\text{C}$, $V_{CC} = 1.425\text{ V}$)
For IGLOO V2 or V5 devices, 1.5 V DC Core Supply Voltage**

Array Voltage VCC (V)	Junction Temperature ($^\circ\text{C}$)					
	-40°C	0°C	25°C	70°C	85°C	100°C
1.425	0.934	0.953	0.971	1.000	1.007	1.013
1.500	0.855	0.874	0.891	0.917	0.924	0.929
1.575	0.799	0.816	0.832	0.857	0.864	0.868

**Table 2-7 • Temperature and Voltage Derating Factors for Timing Delays (normalized to $T_J = 70^\circ\text{C}$, $V_{CC} = 1.14\text{ V}$)
For IGLOO V2, 1.2 V DC Core Supply Voltage**

Array Voltage VCC (V)	Junction Temperature ($^\circ\text{C}$)					
	-40°C	0°C	25°C	70°C	85°C	100°C
1.14	0.967	0.978	0.991	1.000	1.006	1.010
1.20	0.864	0.874	0.885	0.894	0.899	0.902
1.26	0.794	0.803	0.814	0.821	0.827	0.830

Calculating Power Dissipation

Quiescent Supply Current

Quiescent supply current (IDD) calculation depends on multiple factors, including operating voltages (V_{CC} , V_{CCI} , and V_{JTAG}), operating temperature, system clock frequency, and power modes usage. Microsemi recommends using the PowerCalculator and SmartPower software estimation tools to evaluate the projected static and active power based on the user design, power mode usage, operating voltage, and temperature.

Table 2-8 • Power Supply State per Mode

Modes/power supplies	Power Supply Configurations				
	VCC	VCCPLL	VCCI	VJTAG	VPUMP
Flash*Freeze	On	On	On	On	On/off/floating
Sleep	Off	Off	On	Off	Off
Shutdown	Off	Off	Off	Off	Off
No Flash*Freeze	On	On	On	On	On/off/floating

Note: Off: Power supply level = 0 V

Table 2-9 • Quiescent Supply Current (IDD) Characteristics, IGLOO Flash*Freeze Mode*

	Core Voltage	AGL015	AGL030	AGL060	AGL125	AGL250	AGL400	AGL600	AGL1000	Units
Typical (25°C)	1.2 V	4	4	8	13	20	27	30	44	μA
	1.5 V	6	6	10	18	34	51	72	127	μA

Note: *IDD includes VCC, VPUMP, VCCI, VCCPLL, and VMV currents. Values do not include I/O static contribution, which is shown in Table 2-13 on page 2-10 through Table 2-15 on page 2-11 and Table 2-16 on page 2-11 through Table 2-18 on page 2-12 (PDC6 and PDC7).

Table 2-10 • Quiescent Supply Current (IDD) Characteristics, IGLOO Sleep Mode*

	Core Voltage	AGL015	AGL030	AGL060	AGL125	AGL250	AGL400	AGL600	AGL1000	Units
VCCI/VJTAG = 1.2 V (per bank) Typical (25°C)	1.2 V	1.7	1.7	1.7	1.7	1.7	1.7	1.7	1.7	μA
VCCI/VJTAG = 1.5 V (per bank) Typical (25°C)	1.2 V / 1.5 V	1.8	1.8	1.8	1.8	1.8	1.8	1.8	1.8	μA
VCCI/VJTAG = 1.8 V (per bank) Typical (25°C)	1.2 V / 1.5 V	1.9	1.9	1.9	1.9	1.9	1.9	1.9	1.9	μA
VCCI/VJTAG = 2.5 V (per bank) Typical (25°C)	1.2 V / 1.5 V	2.2	2.2	2.2	2.2	2.2	2.2	2.2	2.2	μA
VCCI/VJTAG = 3.3 V (per bank) Typical (25°C)	1.2 V / 1.5 V	2.5	2.5	2.5	2.5	2.5	2.5	2.5	2.5	μA

Note: $IDD = N_{BANKS} \times ICCI$. Values do not include I/O static contribution, which is shown in Table 2-13 on page 2-10 through Table 2-15 on page 2-11 and Table 2-16 on page 2-11 through Table 2-18 on page 2-12 (PDC6 and PDC7).

Table 2-11 • Quiescent Supply Current (IDD) Characteristics, IGLOO Shutdown Mode

	Core Voltage	AGL015	AGL030	Units
Typical (25°C)	1.2 V / 1.5 V	0	0	μA

Table 2-12 • Quiescent Supply Current (IDD), No IGLOO Flash*Freeze Mode¹

	Core Voltage	AGL015	AGL030	AGL060	AGL125	AGL250	AGL400	AGL600	AGL1000	Units
ICCA Current²										
Typical (25°C)	1.2 V	5	6	10	13	18	25	28	42	μA
	1.5 V	14	16	20	28	44	66	82	137	μA
ICCI or IJTAG Current³										
VCCI/VJTAG = 1.2 V (per bank) Typical (25°C)	1.2 V	1.7	1.7	1.7	1.7	1.7	1.7	1.7	1.7	μA
VCCI/VJTAG = 1.5 V (per bank) Typical (25°C)	1.2 V / 1.5 V	1.8	1.8	1.8	1.8	1.8	1.8	1.8	1.8	μA
VCCI/VJTAG = 1.8 V (per bank) Typical (25°C)	1.2 V / 1.5 V	1.9	1.9	1.9	1.9	1.9	1.9	1.9	1.9	μA
VCCI/VJTAG = 2.5 V (per bank) Typical (25°C)	1.2 V / 1.5 V	2.2	2.2	2.2	2.2	2.2	2.2	2.2	2.2	μA
VCCI/VJTAG = 3.3 V (per bank) Typical (25°C)	1.2 V / 1.5 V	2.5	2.5	2.5	2.5	2.5	2.5	2.5	2.5	μA

Notes:

1. $IDD = N_{BANKS} \times ICCI + ICCA$. JTAG counts as one bank when powered.
2. Includes VCC, VPUMP, and VCCPLL currents.
3. Values do not include I/O static contribution (PDC6 and PDC7).

Power per I/O Pin

**Table 2-13 • Summary of I/O Input Buffer Power (per pin) – Default I/O Software Settings
Applicable to Advanced I/O Banks**

	VCCI (V)	Static Power PDC6 (mW) ¹	Dynamic Power PAC9 (μW/MHz) ²
Single-Ended			
3.3 V LVTTTL / 3.3 V LVCMOS	3.3	–	16.27
3.3 V LVCMOS Wide Range ³	3.3	–	16.27
2.5 V LVCMOS	2.5	–	4.65
1.8 V LVCMOS	1.8	–	1.61
1.5 V LVCMOS (JESD8-11)	1.5	–	0.96
1.2 V LVCMOS ⁴	1.2	–	0.58
1.2 V LVCMOS Wide Range ⁴	1.2	–	0.58
3.3 V PCI	3.3	–	17.67
3.3 V PCI-X	3.3	–	17.67
Differential			
LVDS	2.5	2.26	23.39
LVPECL	3.3	5.72	59.05

Notes:

1. P_{DC6} is the static power (where applicable) measured on VCCI.
2. P_{AC9} is the total dynamic power measured on VCCI.
3. All LVCMOS 3.3 V software macros support LVCMOS 3.3 V wide range as specified in the JESD-8B specification.
4. Applicable for IGLOO V2 devices only

**Table 2-14 • Summary of I/O Input Buffer Power (per pin) – Default I/O Software Settings
Applicable to Standard Plus I/O Banks**

	VCCI (V)	Static Power PDC6 (mW) ¹	Dynamic Power PAC9 (μW/MHz) ²
Single-Ended			
3.3 V LVTTTL / 3.3 V LVCMOS	3.3	–	16.41
3.3 V LVCMOS Wide Range ³	3.3	–	16.41
2.5 V LVCMOS	2.5	–	4.75
1.8 V LVCMOS	1.8	–	1.66
1.5 V LVCMOS (JESD8-11)	1.5	–	1.00
1.2 V LVCMOS ⁴	1.2	–	0.61
1.2 V LVCMOS Wide Range ⁴	1.2	–	0.61
3.3 V PCI	3.3	–	17.78
3.3 V PCI-X	3.3	–	17.78

Notes:

1. P_{DC6} is the static power (where applicable) measured on VCCI.
2. P_{AC9} is the total dynamic power measured on VCCI.
3. Applicable for IGLOO V2 devices only.
4. All LVCMOS 3.3 V software macros support LVCMOS 3.3 V wide range as specified in the JESD-8B specification.

**Table 2-15 • Summary of I/O Input Buffer Power (per pin) – Default I/O Software Settings
Applicable to Standard I/O Banks**

	VCCI (V)	Static Power PDC6 (mW) ¹	Dynamic Power PAC9 (μW/MHz) ²
Single-Ended			
3.3 V LVTTTL / 3.3 V LVCMOS	3.3	–	17.24
3.3 V LVCMOS Wide Range ³	3.3	–	17.24
2.5 V LVCMOS	2.5	–	5.64
1.8 V LVCMOS	1.8	–	2.63
1.5 V LVCMOS (JESD8-11)	1.5	–	1.97
1.2 V LVCMOS ⁴	1.2	–	0.57
1.2 V LVCMOS Wide Range ⁴	1.2	–	0.57

Notes:

1. PDC6 is the static power (where applicable) measured on VCCI.
2. PAC9 is the total dynamic power measured on VCCI.
3. All LVCMOS 3.3 V software macros support LVCMOS 3.3 V wide range as specified in the JESD-8B specification.
4. Applicable for IGLOO V2 devices only.

**Table 2-16 • Summary of I/O Output Buffer Power (per pin) – Default I/O Software Settings¹
Applicable to Advanced I/O Banks**

	C _{LOAD} (pF)	VCCI (V)	Static Power PDC7 (mW) ²	Dynamic Power PAC10 (μW/MHz) ³
Single-Ended				
3.3 V LVTTTL / 3.3 V LVCMOS	5	3.3	–	136.95
3.3 V LVCMOS Wide Range ⁴	5	3.3	–	136.95
2.5 V LVCMOS	5	2.5	–	76.84
1.8 V LVCMOS	5	1.8	–	49.31
1.5 V LVCMOS (JESD8-11)	5	1.5	–	33.36
1.2 V LVCMOS ⁵	5	1.2	–	16.24
1.2 V LVCMOS Wide Range ⁵	5	1.2	–	16.24
3.3 V PCI	10	3.3	–	194.05
3.3 V PCI-X	10	3.3	–	194.05
Differential				
LVDS	–	2.5	7.74	156.22
LVPECL	–	3.3	19.54	339.35

Notes:

1. Dynamic power consumption is given for standard load and software default drive strength and output slew.
2. PDC7 is the static power (where applicable) measured on VCCI.
3. PAC10 is the total dynamic power measured on VCCI.
4. All LVCMOS 3.3 V software macros support LVCMOS 3.3 V wide range as specified in the JESD-8B specification.
5. Applicable for IGLOO V2 devices only.

Table 2-17 • Summary of I/O Output Buffer Power (per pin) – Default I/O Software Settings¹
Applicable to Standard Plus I/O Banks

	C_{LOAD} (pF)	VCCI (V)	Static Power PDC7 (mW) ²	Dynamic Power PAC10 (μ W/MHz) ³
Single-Ended				
3.3 V LVTTTL / 3.3 V LVCMOS	5	3.3	–	122.16
3.3 V LVCMOS Wide Range ⁴	5	3.3	–	122.16
2.5 V LVCMOS	5	2.5	–	68.37
1.8 V LVCMOS	5	1.8	–	34.53
1.5 V LVCMOS (JESD8-11)	5	1.5	–	23.66
1.2 V LVCMOS ⁵	5	1.2	–	14.90
1.2 V LVCMOS Wide Range ⁵	5	1.2	–	14.90
3.3 V PCI	10	3.3	–	181.06
3.3 V PCI-X	10	3.3	–	181.06

Notes:

1. Dynamic power consumption is given for standard load and software default drive strength and output slew.
2. P_{DC7} is the static power (where applicable) measured on VCCI.
3. P_{AC10} is the total dynamic power measured on VCCI.
4. All LVCMOS 3.3 V software macros support LVCMOS 3.3 V wide range as specified in the JESD-8B specification.
5. Applicable for IGLOO V2 devices only.

Table 2-18 • Summary of I/O Output Buffer Power (per pin) – Default I/O Software Settings¹
Applicable to Standard I/O Banks

	C_{LOAD} (pF)	VCCI (V)	Static Power PDC7 (mW) ²	Dynamic Power PAC10 (μ W/MHz) ³
Single-Ended				
3.3 V LVTTTL / 3.3 V LVCMOS	5	3.3	–	104.38
3.3 V LVCMOS Wide Range ⁴	5	3.3	–	104.38
2.5 V LVCMOS	5	2.5	–	59.86
1.8 V LVCMOS	5	1.8	–	31.26
1.5 V LVCMOS (JESD8-11)	5	1.5	–	21.96
1.2 V LVCMOS ⁵	5	1.2	–	13.49
1.2 V LVCMOS Wide Range ⁵	5	1.2	–	13.49

Notes:

1. Dynamic power consumption is given for standard load and software default drive strength and output slew.
2. P_{DC7} is the static power (where applicable) measured on VCCI.
3. P_{AC10} is the total dynamic power measured on VCCI.
4. All LVCMOS 3.3 V software macros support LVCMOS 3.3 V wide range as specified in the JESD-8B specification.
5. Applicable for IGLOO V2 devices only.