



Chipsmall Limited consists of a professional team with an average of over 10 year of expertise in the distribution of electronic components. Based in Hongkong, we have already established firm and mutual-benefit business relationships with customers from,Europe,America and south Asia,supplying obsolete and hard-to-find components to meet their specific needs.

With the principle of “Quality Parts,Customers Priority,Honest Operation,and Considerate Service”,our business mainly focus on the distribution of electronic components. Line cards we deal with include Microchip,ALPS,ROHM,Xilinx,Pulse,ON,Everlight and Freescale. Main products comprise IC,Modules,Potentiometer,IC Socket,Relay,Connector.Our parts cover such applications as commercial,industrial, and automotives areas.

We are looking forward to setting up business relationship with you and hope to provide you with the best service and solution. Let us make a better world for our industry!



Contact us

Tel: +86-755-8981 8866 Fax: +86-755-8427 6832

Email & Skype: info@chipsmall.com Web: www.chipsmall.com

Address: A1208, Overseas Decoration Building, #122 Zhenhua RD., Futian, Shenzhen, China



Description

The AH1804 is a micropower Omnipolar Hall effect switch IC with a single output driver with internal pull up and pull down capability. Designed for portable and battery powered equipment such as cellular phones and portable PCs the average supply current is only 12 μ A at 3.3V. To support battery powered equipment the AH1804 can operate over the supply range of 2.5V to 3.6V and uses a hibernating clocking system to minimize the power consumption.

The output is activated with either a north or south pole of sufficient strength. When the magnetic flux density (**B**) is larger than operate point (**Bop**), the output will be turned on (pulled low) and held until **B** is lower than release point (**Brp**).

The AH1804 is available in SC59 and small low profile DFN1216-4 packages.

Features

- Omnipolar operation (North or South pole)
- Low supply voltage 2.5V to 3.6V
- Micropower operation
- No external pull up resistors required
- Chopper stabilized design
 - Superior temperature stability
 - Extremely Low Switch-Point Drift
 - Insensitive to Physical Stress
- Good RF noise immunity
- -40°C to 85°C operating temperature
- Small low profile DFN1216-4 and SC59 packages
- ESD (HBM) > 5KV
- "Green" Molding Compound

Pin Assignments

(Top View)

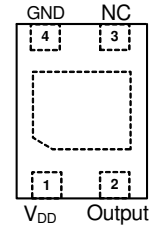

DFN1216-4

(Top View)

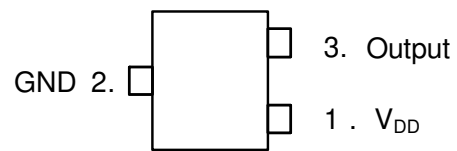

SC59

Applications

- Cover switch in clam-shell and slide cellular phones
- Cover switch in portable PC's, Tablets and PDA
- Display screen open/close detect in Digital camcorders
- Contact-less switch in portable battery powered consumer and industrial products

Typical Application Circuit

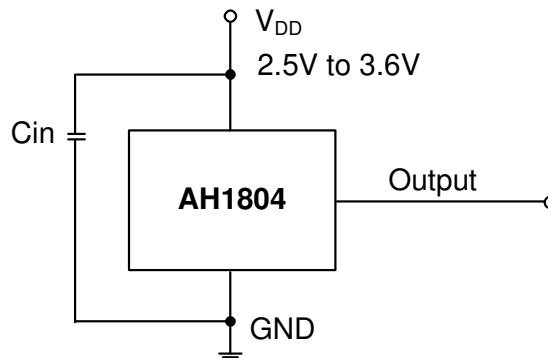

Note: Cin is for power stabilization and to strengthen the noise immunity, C = 100nF or higher must be used.

Pin Descriptions

Pin Name	P/I/O	Description
V _{DD}	P/I	Power Supply Input
GND	P/I	Ground
Output	O	Output Pin
NC	NC	No Connection (Note 1)

Notes: 1. NC is "No Connection" which is not connected internally. This pin can be left open or tied to ground.

Functional Block Diagram

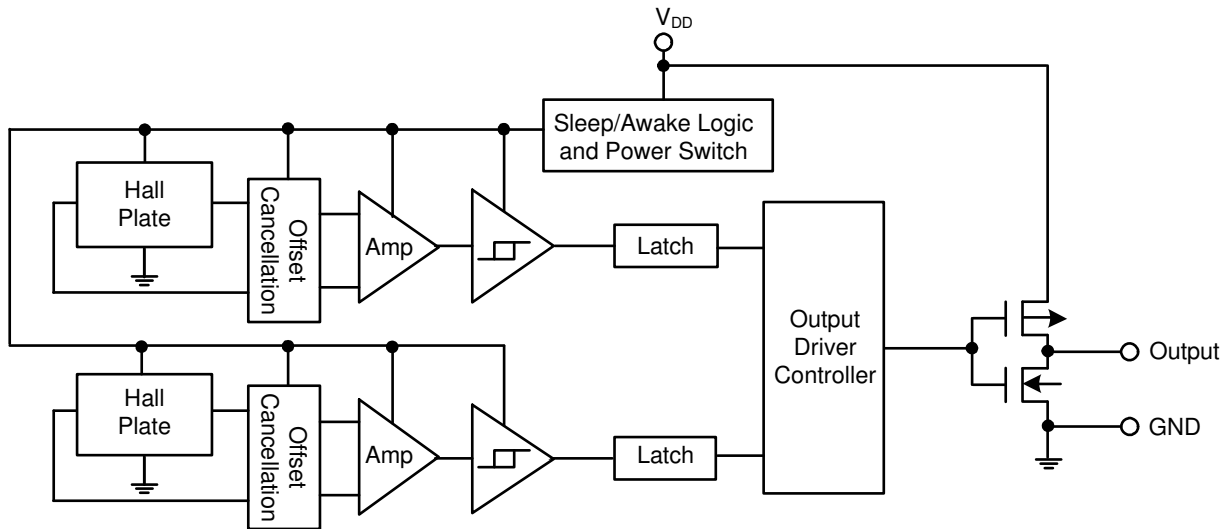

Absolute Maximum Ratings ($T_A = 25^\circ\text{C}$, Note 2)

Symbol	Characteristics	Values	Unit
V_{DD}	Supply voltage (Note 3)	5.0	V
$V_{DD\ rev}$	Reverse supply voltage	-0.3	V
B	Magnetic flux density	Unlimited	
T_s	Storage Temperature Range	-65 to +150	$^\circ\text{C}$
P_D	Package Power Dissipation	DFN1216-4	230
		SC59	270
T_J	Maximum Junction Temperature	150	$^\circ\text{C}$

- Notes:
- Stresses greater than the 'Absolute Maximum Ratings' specified above, may cause permanent damage to the device. These are stress ratings only; functional operation of the device at these or any other conditions exceeding those indicated in this specification is not implied. Device reliability may be affected by exposure to absolute maximum rating conditions for extended periods of time
 - The absolute maximum of 5V is a transient stress rating and is not meant as functional operating conditions. It is not recommended to operate the device at the absolute maximum rated conditions for any period of time.

Recommended Operating Conditions ($T_A = 25^\circ\text{C}$)

Symbol	Characteristics	Conditions	Rating	Unit
V_{DD}	Supply Voltage	$C_{IN} = 0.1\mu\text{F}$ (Note 4)	2.5 to 3.6	V
T_A	Operating Temperature Range	Operating	-40 to +85	$^\circ\text{C}$

- Notes:
- Decoupling capacitor $C_{IN} = 100\text{nF}$ or higher must be used for full 2.5V to 3.6V supply range.

Electrical Characteristics ($T_A = 25^\circ\text{C}$, $V_{DD} = 3.3\text{V}$, unless otherwise specified)

Symbol	Characteristics	Conditions	Min	Typ.	Max	Unit
V_{OL}	Output Low Voltage (on)	$I_{OUT} = 1\text{mA}$	—	0.1	0.2	V
V_{OH}	Output High Voltage (off)	$I_{OUT} = -1\text{mA}$	$V_{DD}-0.2$	$V_{DD}-0.1$	—	V
$I_{dd(en)}$	Supply current	Chip enable	—	4	—	mA
$I_{dd(dis)}$		Chip disable	—	8	—	μA
$I_{dd(avg)}$		Average supply current,	—	12	—	μA
T_{awake}	Awake Time	(Note 5)	—	50	100	μs
T_{period}	Period	(Note 5)	—	50	100	ms
D.C.	Duty Cycle		—	0.1	—	%

- Notes:
- When power is initially on, the operating V_{DD} (2.5V to 3.6V) must be applied to be guaranteed for the output sampling. The output state is valid after the second operating phase (typical 100ms).

Magnetic Characteristics ($T_A = 25^\circ\text{C}$, $V_{DD} = 3.3\text{V}$, Note 6)

(1mT=10 Gauss)

Symbol	Characteristics	Min	Typ.	Max	Unit
Bops(south pole to brand side)	Operation Point	20	40	60	Gauss
Bopn(north pole to brand side)		-60	-40	-20	
Brps(south pole to brand side)	Release Point	15	32	-	
Brpn(north pole to brand side)		-	-32	-15	
Bhy (Bopx - Brpx)	Hysteresis		8	-	

Notes: 6. The magnetic characteristics may vary with operating temperature and after soldering.

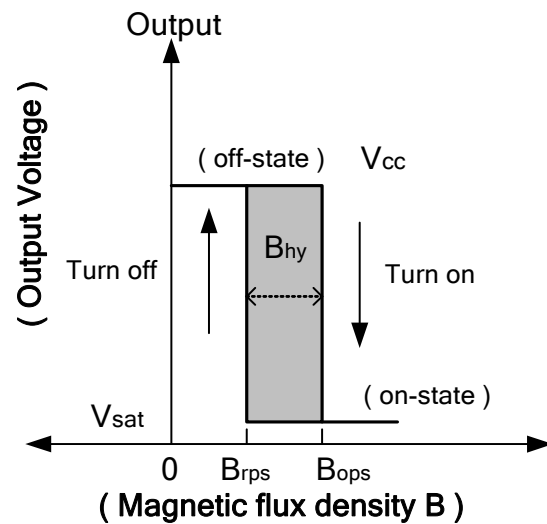
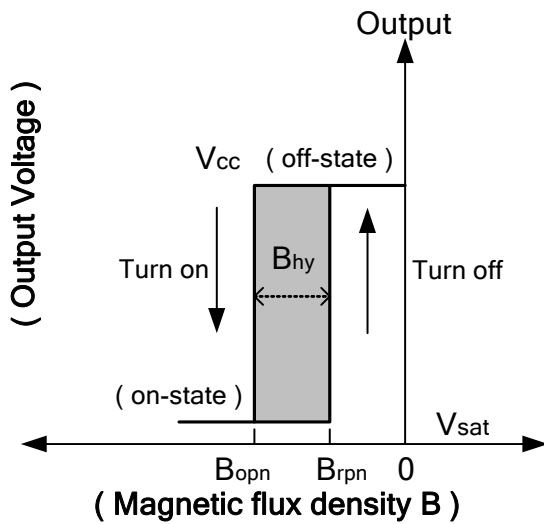

Typical Characteristics

Typical Switch Point Bop and Brp vs. Temperature

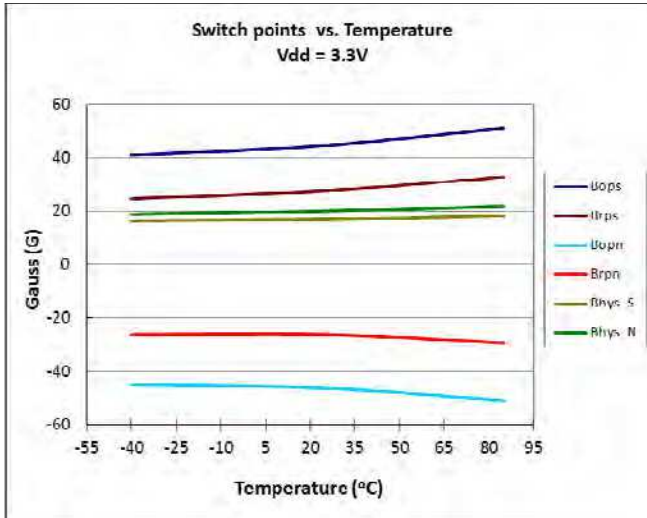

Typical Switch Points Bop and Brp vs. Supply Voltage

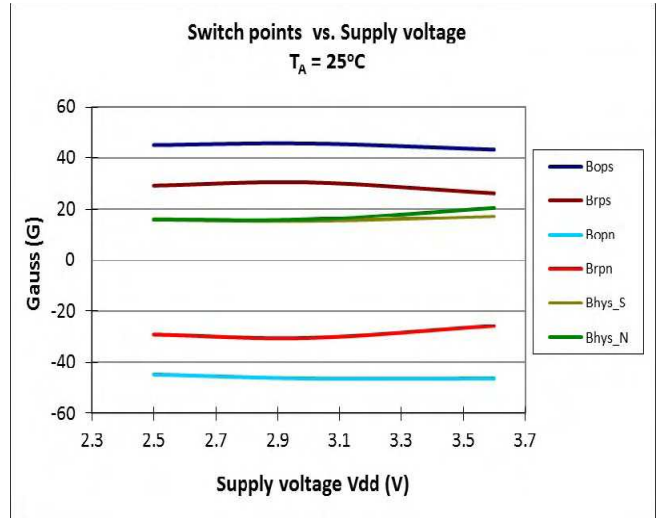

Average Supply Current vs. Temperature

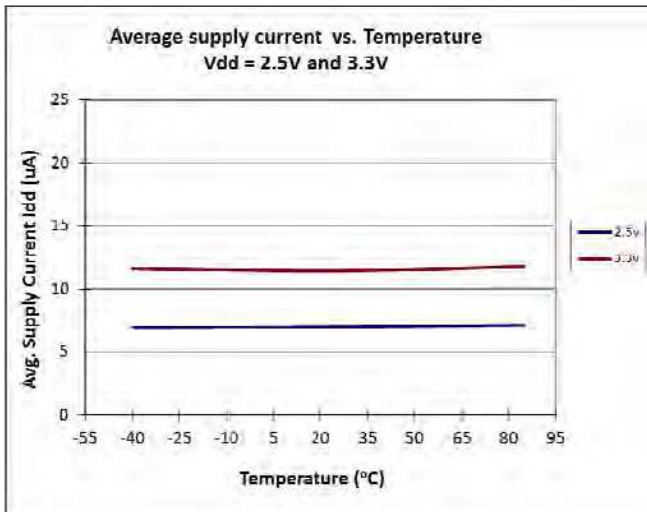

Average Supply Current vs. Supply Voltage

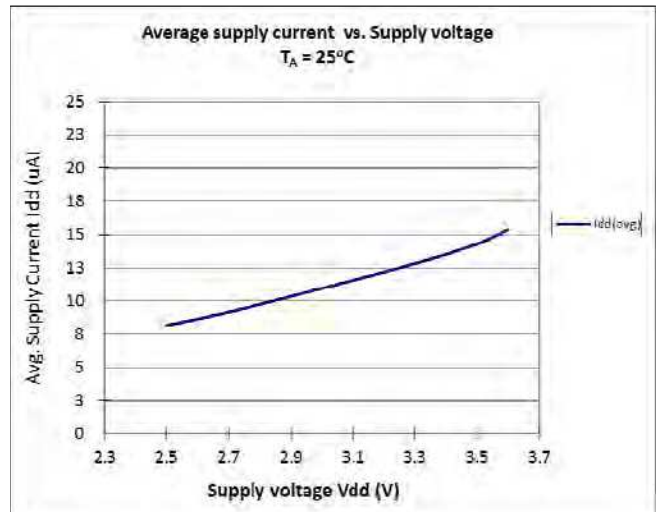

Ordering Information

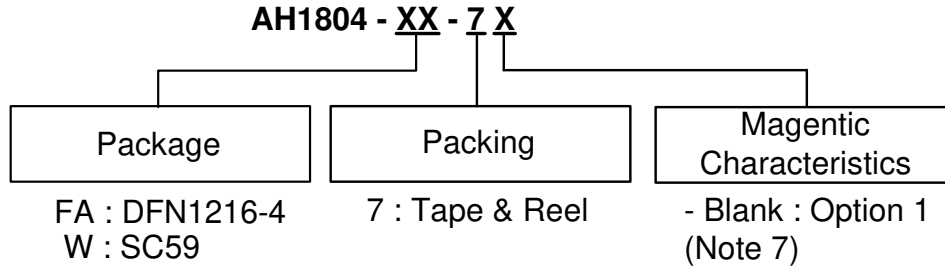

Device (Note 8)	Package Code	Packaging (Note 9)	7" Tape and Reel		Magnetic Characteristics (Note 7)
			Quantity	Part Number Suffix	
AH1804-FA-7	FA	DFN1216-4	3000/Tape & Reel	-7	-Blank
AH1804-W-7	W	SC59	3000/Tape & Reel	-7	-Blank

Notes: 7. Please refer the Magnetic Characteristics table.
 8. EU Directive 2002/95/EC (RoHS). All applicable RoHS exemptions applied. Please visit our website at http://www.diodes.com/products/lead_free.html.
 9. Pad layout as shown on Diodes Inc. suggested pad layout document AP02001, which can be found on our website at <http://www.diodes.com/datasheets/ap02001.pdf>

Marking Information

(1) DFN1216-4

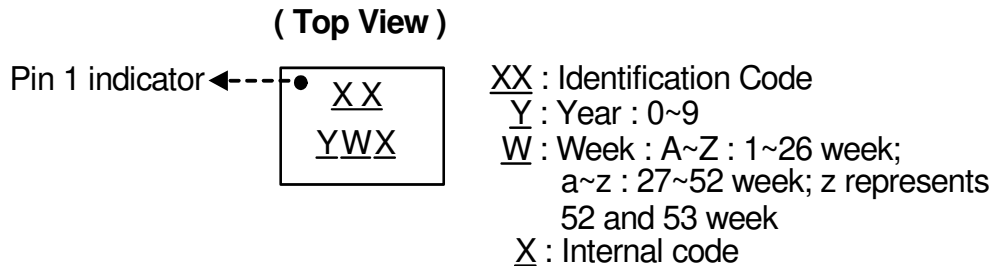

Part Number	Package	Identification Code
AH1804-FA-7	DFN1216-4	KJ

(2) SC59 (commonly known as SOT23 in Asia)

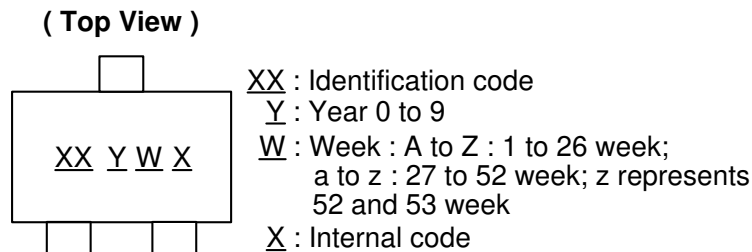

Part Number	Package	Identification Code
AH1804-W-7	SC59	WJ

Package Outline Dimensions (All Dimensions in mm)

(1) Package type: DFN1216-4

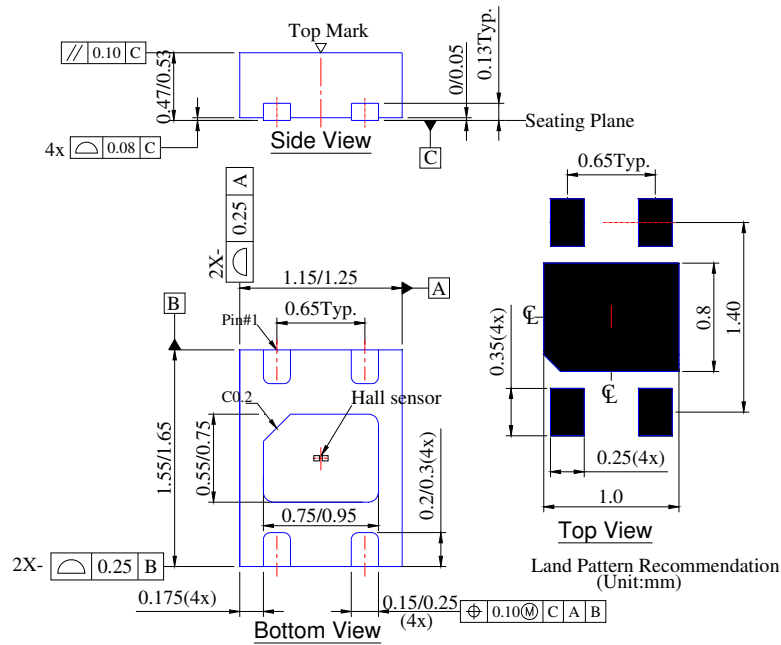

(2) Package Type: SC59 (commonly known as SOT23 in Asia)

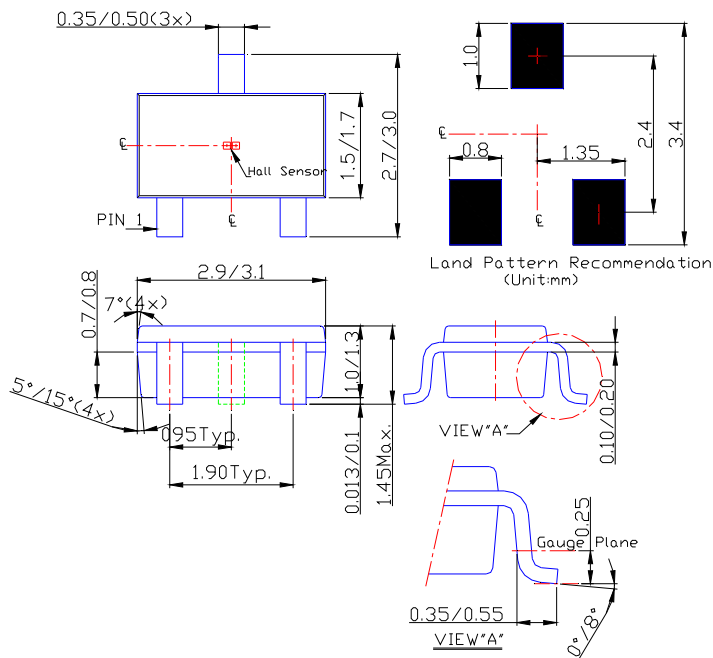

Taping Orientation (Note 10)

DFN1216-4

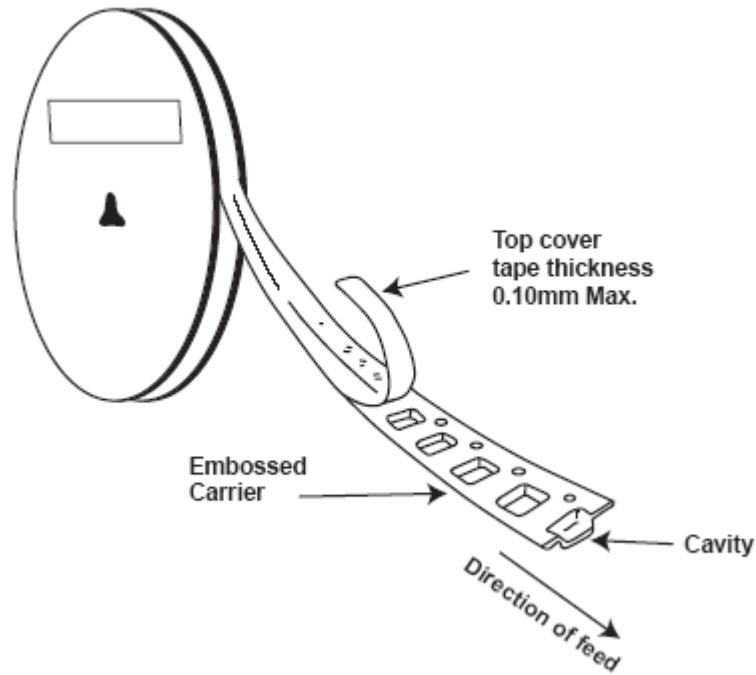
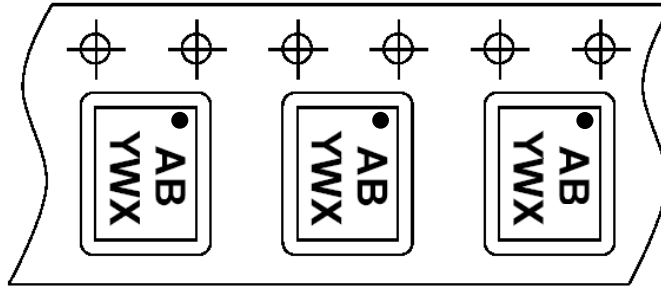

Notes: 10. The taping orientation of the other package type can be found on our website at <http://www.diodes.com/datasheets/ap02007.pdf>.

IMPORTANT NOTICE

DIODES INCORPORATED MAKES NO WARRANTY OF ANY KIND, EXPRESS OR IMPLIED, WITH REGARDS TO THIS DOCUMENT, INCLUDING, BUT NOT LIMITED TO, THE IMPLIED WARRANTIES OF MERCHANTABILITY AND FITNESS FOR A PARTICULAR PURPOSE (AND THEIR EQUIVALENTS UNDER THE LAWS OF ANY JURISDICTION).

Diodes Incorporated and its subsidiaries reserve the right to make modifications, enhancements, improvements, corrections or other changes without further notice to this document and any product described herein. Diodes Incorporated does not assume any liability arising out of the application or use of this document or any product described herein; neither does Diodes Incorporated convey any license under its patent or trademark rights, nor the rights of others. Any Customer or user of this document or products described herein in such applications shall assume all risks of such use and will agree to hold Diodes Incorporated and all the companies whose products are represented on Diodes Incorporated website, harmless against all damages.

Diodes Incorporated does not warrant or accept any liability whatsoever in respect of any products purchased through unauthorized sales channel.

Should Customers purchase or use Diodes Incorporated products for any unintended or unauthorized application, Customers shall indemnify and hold Diodes Incorporated and its representatives harmless against all claims, damages, expenses, and attorney fees arising out of, directly or indirectly, any claim of personal injury or death associated with such unintended or unauthorized application.

Products described herein may be covered by one or more United States, international or foreign patents pending. Product names and markings noted herein may also be covered by one or more United States, international or foreign trademarks.

LIFE SUPPORT

Diodes Incorporated products are specifically not authorized for use as critical components in life support devices or systems without the express written approval of the Chief Executive Officer of Diodes Incorporated. As used herein:

A. Life support devices or systems are devices or systems which:

1. are intended to implant into the body, or
2. support or sustain life and whose failure to perform when properly used in accordance with instructions for use provided in the labeling can be reasonably expected to result in significant injury to the user.

B. A critical component is any component in a life support device or system whose failure to perform can be reasonably expected to cause the failure of the life support device or to affect its safety or effectiveness.

Customers represent that they have all necessary expertise in the safety and regulatory ramifications of their life support devices or systems, and acknowledge and agree that they are solely responsible for all legal, regulatory and safety-related requirements concerning their products and any use of Diodes Incorporated products in such safety-critical, life support devices or systems, notwithstanding any devices- or systems-related information or support that may be provided by Diodes Incorporated. Further, Customers must fully indemnify Diodes Incorporated and its representatives against any damages arising out of the use of Diodes Incorporated products in such safety-critical, life support devices or systems.

Copyright © 2011, Diodes Incorporated

www.diodes.com