



Chipsmall Limited consists of a professional team with an average of over 10 year of expertise in the distribution of electronic components. Based in Hongkong, we have already established firm and mutual-benefit business relationships with customers from,Europe,America and south Asia,supplying obsolete and hard-to-find components to meet their specific needs.

With the principle of "Quality Parts,Customers Priority,Honest Operation,and Considerate Service",our business mainly focus on the distribution of electronic components. Line cards we deal with include Microchip,ALPS,ROHM,Xilinx,Pulse,ON,Everlight and Freescale. Main products comprise IC,Modules,Potentiometer,IC Socket,Relay,Connector.Our parts cover such applications as commercial,industrial, and automotives areas.

We are looking forward to setting up business relationship with you and hope to provide you with the best service and solution. Let us make a better world for our industry!



Contact us

Tel: +86-755-8981 8866 Fax: +86-755-8427 6832

Email & Skype: info@chipsmall.com Web: www.chipsmall.com

Address: A1208, Overseas Decoration Building, #122 Zhenhua RD., Futian, Shenzhen, China





AK09916

3-axis Electronic Compass

1. General Description

AK09916 is 3-axis electronic compass IC with high sensitive Hall sensor technology. Small package of AK09916 incorporates magnetic sensors for detecting terrestrial magnetism in the X-axis, Y-axis, and Z-axis, a sensor driving circuit, signal amplifier chain, and an arithmetic circuit for processing the signal from each sensor. Self-test function is also incorporated. From its compact foot print and thin package feature, it is suitable for map heading up purpose in Smart phone to realize pedestrian navigation function.

2. Features

- Functions:
 - 3-axis magnetometer device suitable for compass application
 - Built-in A to D Converter for magnetometer data out
 - 16-bit data out for each 3-axis magnetic component
 - Sensitivity: 0.15 μ T/LSB (typ.)
 - Serial interface
 - I²C bus interface
 - Standard and Fast modes compliant with Philips I²C specification Ver.2.1
 - Operation mode
 - Power-down, Single measurement, Continuous measurement and Self-test
 - DRDY function for measurement data ready
 - Magnetic sensor overflow monitor function
 - Built-in oscillator for internal clock source
 - Power on Reset circuit
 - Self-test function with internal magnetic source
 - Built-in magnetic sensitivity adjustment circuit
- Operating temperatures:
 - -30°C to +85°C
- Operating supply voltage:
 - +1.65V to +1.95V
- Current consumption:
 - Power-down: 1 μ A (typ.)
 - Measurement:
 - Average current consumption at 100 Hz repetition rate: 1.1mA (typ.)
- Package:
 - AK09916C 5-pin WL-CSP (BGA): 1.2 mm \times 0.8 mm \times 0.5mm

3. Table of Contents

1. General Description	1
2. Features	1
3. Table of Contents	2
4. Block Diagram and Functions.....	3
5. Pin Configurations and Functions	4
6. Absolute Maximum Ratings.....	4
7. Recommended Operating Conditions	4
8. Electrical Characteristics.....	5
8.1. DC Characteristics.....	5
8.2. AC Characteristics.....	6
8.3. Analog Circuit Characteristics.....	6
8.4. I ² C Bus Interface	7
9. Function Descriptions	8
9.1. Power States	8
9.2. Reset Functions	8
9.3. Operation Modes.....	9
9.4. Description of Each Operation Mode.....	10
9.4.1. Power-down Mode	10
9.4.2. Single Measurement Mode.....	10
9.4.3. Continuous Measurement Mode 1, 2, 3 and 4.....	11
9.4.4. Self-test Mode.....	14
10. Serial Interface	15
10.1. I ² C Bus Interface	15
10.1.1. Data Transfer	15
10.1.2. WRITE Instruction	17
10.1.3. READ Instruction.....	18
11. Registers.....	19
11.1. Description of Registers	19
11.2. Register Map	20
11.3. Detailed Description of Register	21
11.3.1. WIA: Who I Am	21
11.3.2. RSV: Reserved register.....	21
11.3.3. ST1: Status 1.....	21
11.3.4. HXL to HZH: Measurement data	22
11.3.5. TMPS: Dummy register.....	22
11.3.6. ST2: Status 2.....	23
11.3.7. CNTL1: Dummy register.....	23
11.3.8. CNTL2: Control 2.....	23
11.3.9. CNTL3: Control 3.....	24
11.3.10. TS1, TS2: Test register.....	24
12. Example of Recommended External Connection	25
13. Package	26
13.1. Marking.....	26
13.2. Pin Assignment.....	26
13.3. Outline Dimensions.....	27
13.4. Recommended Foot Print Pattern.....	27
14. Relationship between the Magnetic Field and Output Code.....	28
IMPORTANT NOTICE.....	29

4. Block Diagram and Functions

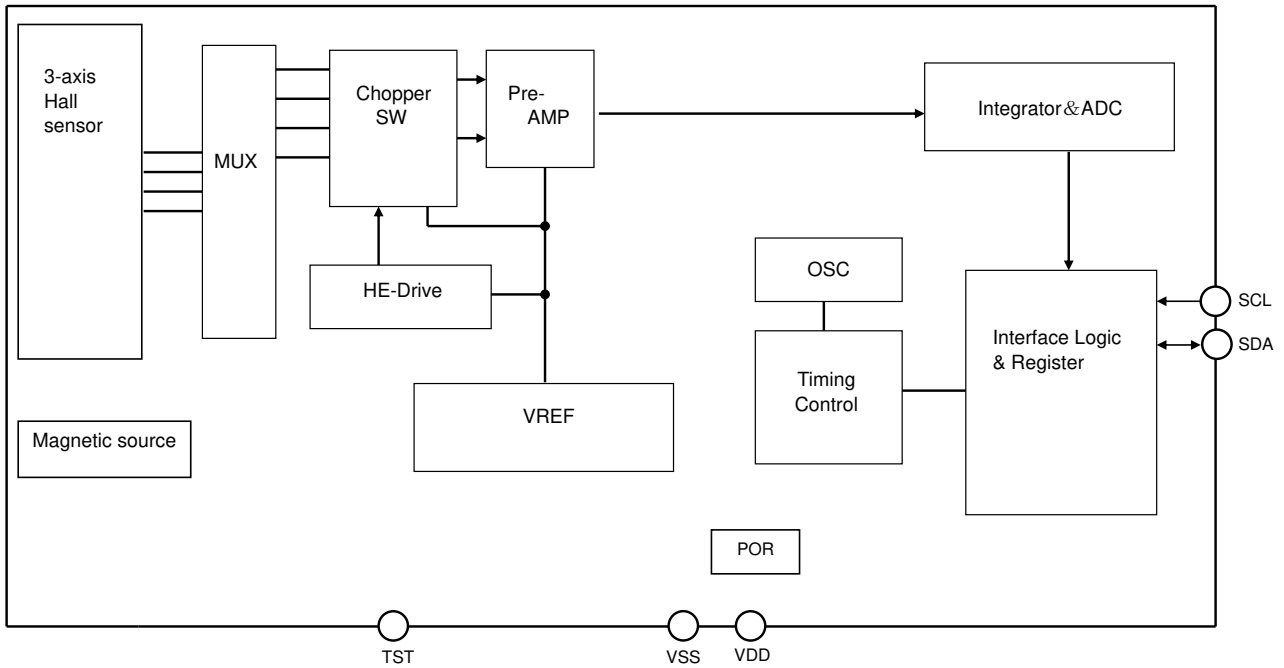

Block	Function
3-axis Hall sensor	Monolithic Hall elements.
MUX	Multiplexer for selecting Hall elements.
Chopper SW	Performs chopping.
HE-Drive	Magnetic sensor drive circuit for constant-current driving of sensor.
Pre-AMP	Fixed-gain differential amplifier used to amplify the magnetic sensor signal.
Integrator & ADC	Integrates and amplifies Pre-AMP output and performs analog-to-digital conversion.
OSC	Generates an operating clock for sensor measurement.
POR	Power On Reset circuit. Generates reset signal on rising edge of VDD.
VREF	Generates reference voltage and current.
Interface Logic & Register	Exchanges data with an external CPU. I ² C bus interface using two pins, namely, SCL and SDA. Standard and Fast modes are supported.
Timing Control	Generates a timing signal required for internal operation from a clock generated by the OSC.
Magnetic Source	Generates magnetic field for Self-test of magnetic sensor.

5. Pin Configurations and Functions

Pin No.	Pin name	I/O	Type	Function
A1	VSS	-	-	Ground pin.
A3	SCL	I	CMOS	Control data clock input pin. Input: Schmidt trigger
B1	VDD	-	Power	Positive power supply pin.
B2	TST	I/O	CMOS	Test pin. Connect to VSS or VDD or keep this pin non-connected.
B3	SDA	I/O	CMOS	Control data input/output pin. Input: Schmidt trigger, Output: Open-drain

6. Absolute Maximum Ratings

V_{SS} = 0V

Parameter	Symbol	Min.	Max.	Unit
Power supply voltage	V _{dd}	-0.3	+2.5	V
Input voltage (except for power supply pin)	V _{IN}	-0.3	+2.5	V
Input current (except for power supply pin)	I _{IN}	-	±10	mA
Storage temperature	T _{st}	-40	+125	°C

If the device is used in conditions exceeding these values, the device may be destroyed. Normal operations are not guaranteed in such exceeding conditions.

7. Recommended Operating Conditions

V_{SS} = 0V

Parameter	Symbol	Min.	Typ.	Max.	Unit
Operating temperature	T _a	-30		+85	°C
Power supply voltage	V _{dd}	1.65	1.8	1.95	V

8. Electrical Characteristics

The following conditions apply unless otherwise noted:

Vdd = 1.65V to 1.95V, Temperature range = -30°C to +85°C.

8.1. DC Characteristics

Parameter	Symbol	Pin	Condition	Min.	Typ.	Max.	Unit
High level input voltage	VIH	SCL SDA		70%Vdd			V
Low level input voltage	VIL	SCL SDA		-0.3		30%Vdd	V
Input current	IIN	SCL SDA	VIN = Vss or Vdd	-10		+10	μA
Hysteresis input voltage (Note 1)	VHS	SCL SDA		10%Vdd			V
Low level output voltage (Note 2)	VOL	SDA	IOL ≤ +3mA			20%Vdd	V
Current consumption (Note 3)	IDD1	VDD	Power-down mode Vdd = 1.95V		1	3	μA
	IDD2		When magnetic sensor is driven		1.5	3	mA
	IDD3		Self-test mode		2.5	4	mA

(Note 1) Schmitt trigger input (reference value for design)

(Note 2) Output is Open-drain. Connect a pull-up resistor externally. Maximum capacitive load: 400pF (Capacitive load of each bus line for I²C bus interface).

(Note 3) Without any resistance load. It does not include the current consumed by external loads (pull-down resistor, etc.). SDA = SCL = Vdd or 0V.

8.2. AC Characteristics

Parameter	Symbol	Pin	Condition	Min.	Typ.	Max.	Unit
Power supply rise time (Note 4)	PSUP	VDD	Period of time that VDD changes from 0.2V to Vdd.			50	ms
POR completion time (Note 4)	PORT		Period of time after PSUP to Power-down mode (Note 5)			100	μs
Power supply turn off voltage (Note 4)	SDV	VDD	Turn off voltage to enable POR to restart (Note 5)			0.2	V
Power supply turn on interval (Note 4)	PSINT	VDD	Period of time that voltage lower than SDV needed to be kept to enable POR to restart (Note 5)	100			μs
Wait time before mode setting	Twait			100			μs

(Note 4) Reference value for design.

(Note 5) When POR circuit detects the rise of VDD voltage, it resets internal circuits and initializes the registers. After reset, AK09916 transits to Power-down mode.

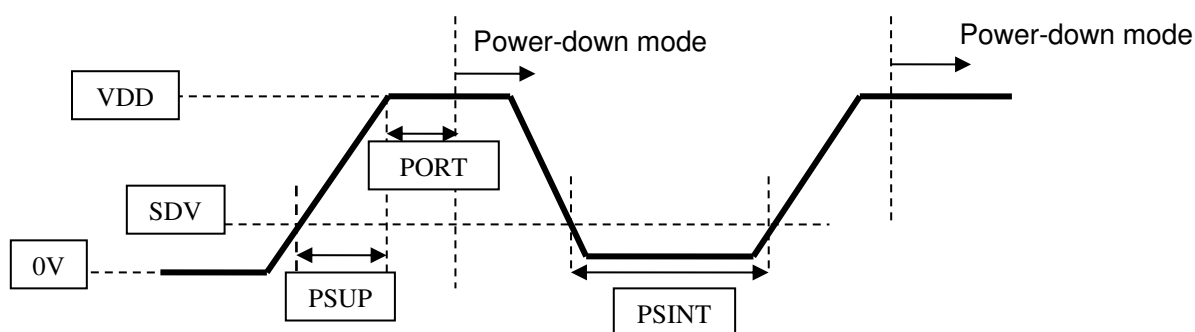

8.3. Analog Circuit Characteristics

Parameter	Symbol	Condition	Min.	Typ.	Max.	Unit
Measurement data output bit	DBIT		-	16	-	bit
Time for measurement	TSM	Single measurement mode		7.2	8.2	ms
Magnetic sensor sensitivity	BSE	Ta = 25 °C	0.1425	0.15	0.1575	μT/LSB
Magnetic sensor measurement range (Note 6)	BRG	Ta = 25 °C	±4670	±4912	±5160	μT
Magnetic sensor initial offset (Note 7)		Ta = 25 °C	-2000		+2000	LSB

(Note 6) Reference value for design

(Note 7) Value of measurement data register on shipment test without applying magnetic field on purpose.

8.4. I²C Bus Interface

I²C bus interface is compliant with Standard mode and Fast mode. Standard/Fast mode is selected automatically by fSCL.

Standard mode

$$f_{SCL} \leq 100\text{kHz}$$

Symbol	Parameter	Min.	Typ.	Max.	Unit
fSCL	SCL clock frequency			100	kHz
tHIGH	SCL clock "High" time	4.0			μs
tLOW	SCL clock "Low" time	4.7			μs
tR	SDA and SCL rise time			1.0	μs
tF	SDA and SCL fall time			0.3	μs
tHD:STA	Start Condition hold time	4.0			μs
tSU:STA	Start Condition setup time	4.7			μs
tHD:DAT	SDA hold time (vs. SCL falling edge)	0			μs
tSU:DAT	SDA setup time (vs. SCL rising edge)	250			ns
tSU:STO	Stop Condition setup time	4.0			μs
tBUF	Bus free time	4.7			μs

Fast mode

$$100\text{kHz} \leq f_{SCL} \leq 400\text{kHz}$$

Symbol	Parameter	Min.	Typ.	Max.	Unit
fSCL	SCL clock frequency			400	kHz
tHIGH	SCL clock "High" time	0.6			μs
tLOW	SCL clock "Low" time	1.3			μs
tR	SDA and SCL rise time			0.3	μs
tF	SDA and SCL fall time			0.3	μs
tHD:STA	Start Condition hold time	0.6			μs
tSU:STA	Start Condition setup time	0.6			μs
tHD:DAT	SDA hold time (vs. SCL falling edge)	0			μs
tSU:DAT	SDA setup time (vs. SCL rising edge)	100			ns
tSU:STO	Stop Condition setup time	0.6			μs
tBUF	Bus free time	1.3			μs
tSP	Noise suppression pulse width			50	ns

[I²C bus interface timing]

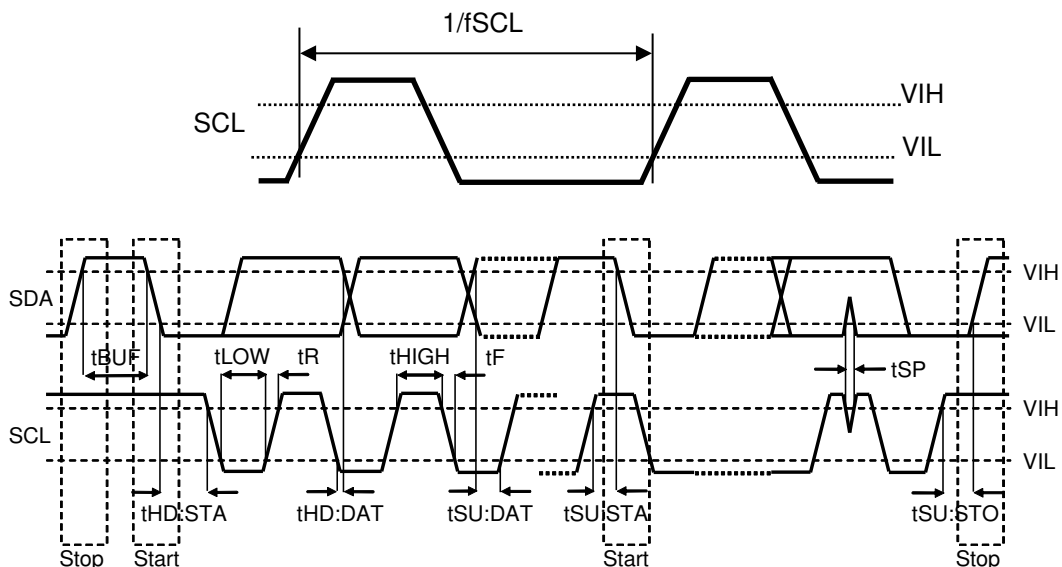

9. Function Descriptions

9.1. Power States

When VDD is turned on from Vdd = OFF (0V), all registers in AK09916 are initialized by POR circuit and AK09916 transits to Power-down mode.

Table 9.1. Power state

State	VDD	Power state
1	OFF (0V)	OFF It doesn't affect external interface.
2	1.65V to 1.95V	ON

9.2. Reset Functions

Power on Reset (POR) works until Vdd reaches to the operation effective voltage (about 1.1V: reference value for design) on power-on sequence. After POR is completed, all registers are initialized and AK09916 transits to Power-down mode.

When Vdd = 1.65 to 1.95V, POR circuit is active.

AK09916 has two types of reset;

- (1) Power on Reset (POR)
When Vdd rise is detected, POR circuit operates, and AK09916 is reset.
- (2) Soft reset
AK09916 is reset by setting SRST bit. When AK09916 is reset, all registers are initialized and AK09916 transits to Power-down mode.

9.3. Operation Modes

AK09916 has following seven operation modes:

- (1) Power-down mode
- (2) Single measurement mode
- (3) Continuous measurement mode 1
- (4) Continuous measurement mode 2
- (5) Continuous measurement mode 3
- (6) Continuous measurement mode 4
- (7) Self-test mode

By setting CNTL2 register MODE[4:0] bits, the operation set for each mode is started. A transition from one mode to another is shown below.

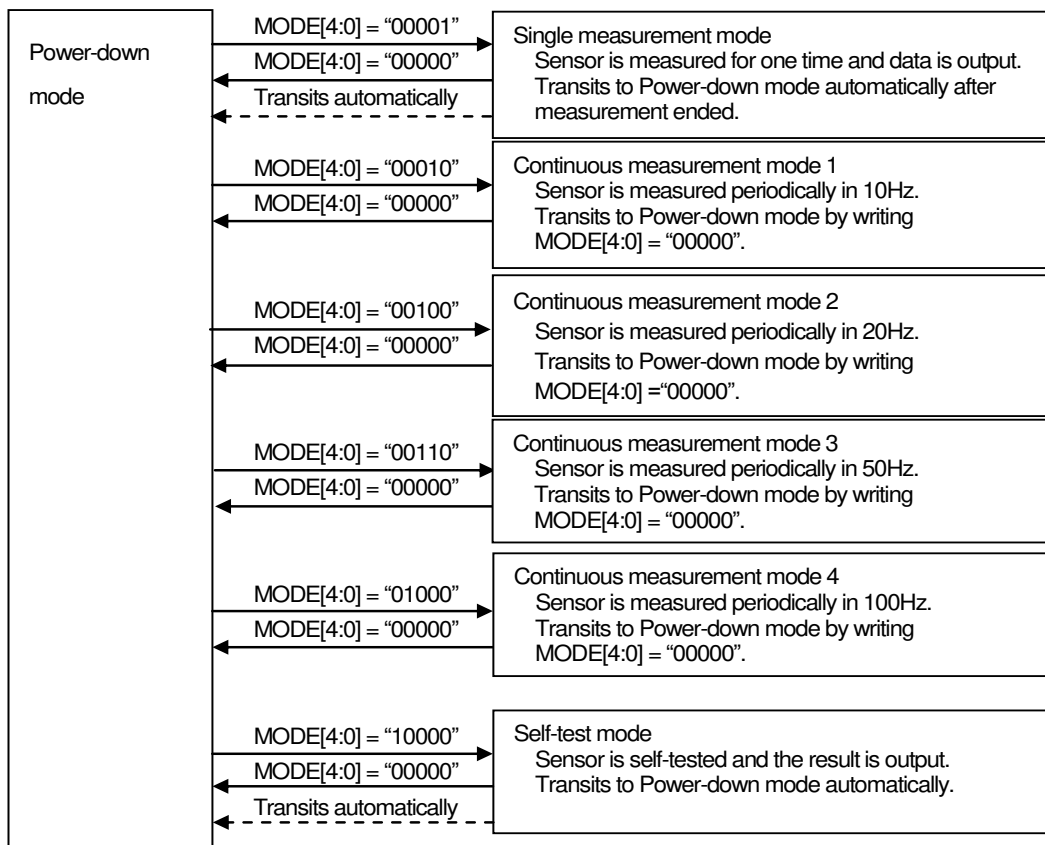

Figure 9.1. Operation mode

When power is turned ON, AK09916 is in Power-down mode. When a specified value is set to MODE[4:0] bits, AK09916 transits to the specified mode and starts operation. When user wants to change operation mode, transit to Power-down mode first and then transit to other modes. After Power-down mode is set, at least 100 μs (Twait) is needed before setting another mode

9.4. Description of Each Operation Mode

9.4.1. Power-down Mode

Power to almost all internal circuits is turned off. All registers are accessible in Power-down mode. Data stored in read/write registers are remained. They can be reset by soft reset.

9.4.2. Single Measurement Mode

When Single measurement mode (MODE[4:0] bits = "00001") is set, magnetic sensor measurement is started. After magnetic sensor measurement and signal processing is finished, measurement magnetic data is stored to measurement data registers (HXL to HZH), then AK09916 transits to Power-down mode automatically. On transition to Power-down mode, MODE[4:0] bits turns to "00000". At the same time, DRDY bit in ST1 register turns to "1". This is called "Data Ready". When any of measurement data register (HXL to TMPS) or ST2 register is read, DRDY bit turns to "0". It remains "1" on transition from Power-down mode to another mode. (Figure 9.2.)

When sensor is measuring (Measurement period), measurement data registers (HXL to TMPS) keep the previous data. Therefore, it is possible to read out data even in measurement period. Data read out in measurement period are previous data.(Figure 9.3.)

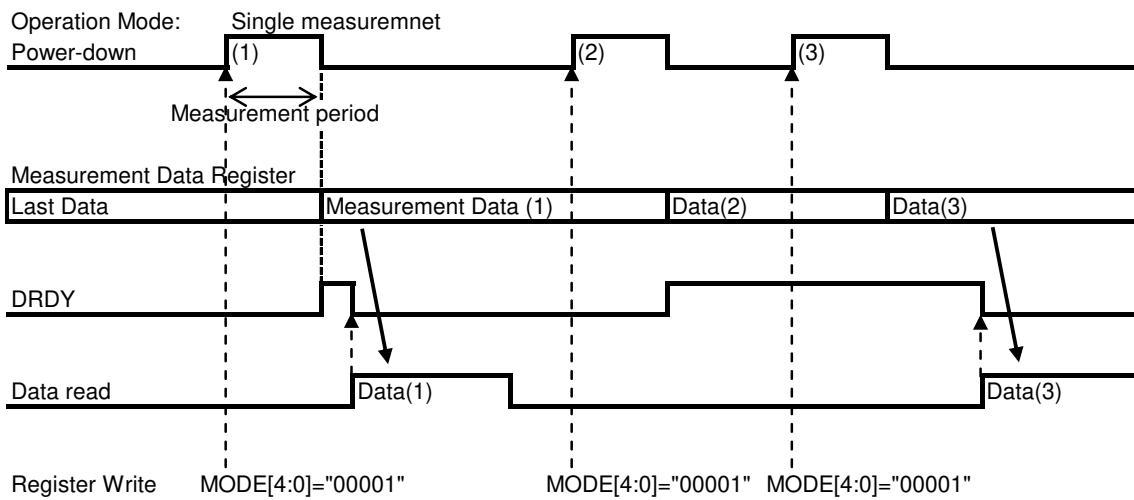

Figure 9.2. Single measurement mode when data is read out of measurement period

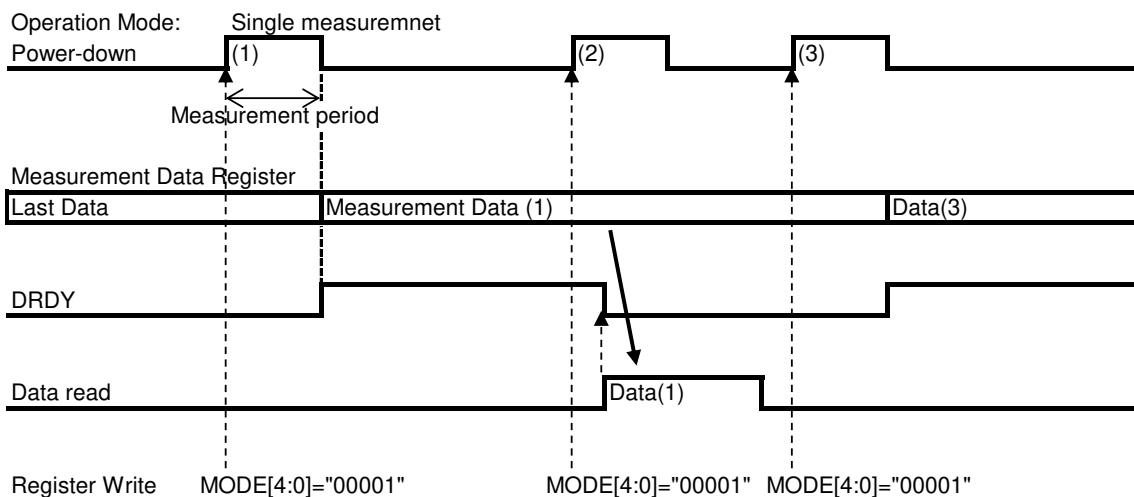

Figure 9.3. Single measurement mode when data read started during measurement period

9.4.3. Continuous Measurement Mode 1, 2, 3 and 4

When Continuous measurement mode 1 (MODE[4:0] bits = “00010”), 2 (MODE[4:0] bits = “00100”), 3 (MODE[4:0] bits = “00110”) or 4 (MODE[4:0] bits = “01000”) is set, magnetic sensor measurement is started periodically at 10 Hz, 20 Hz, 50 Hz or 100 Hz respectively. After magnetic sensor measurement and signal processing is finished, measurement magnetic data is stored to measurement data registers (HXL to HZH) and all circuits except for the minimum circuit required for counting cycle length are turned off (PD). When the next measurement timing comes, AK09916 wakes up automatically from PD and starts measurement again.

Continuous measurement mode ends when Power-down mode (MODE[4:0] bits = “00000”) is set. It repeats measurement until Power-down mode is set.

When Continuous measurement mode 1 (MODE[4:0] bits = “00010”), 2 (MODE[4:0] bits = “00100”), 3 (MODE[4:0] bits = “00110”) or 4 (MODE[4:0] bits = “01000”) is set again while AK09916 is already in Continuous measurement mode, a new measurement starts. ST1, ST2 and measurement data registers (HXL to TMPS) will not be initialized by this.

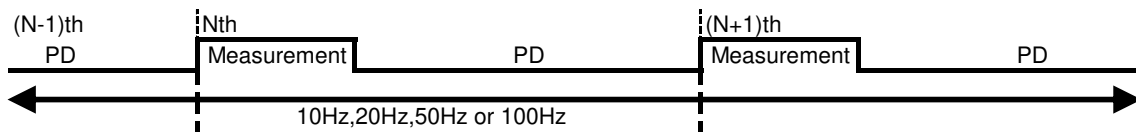

Figure 9.4. Continuous measurement mode

9.4.3.1. Data Ready

When measurement data is stored and ready to be read, DRDY bit in ST1 register turns to “1”. This is called “Data Ready”. When measurement is performed correctly, AK09916 becomes Data Ready on transition to PD after measurement.

9.4.3.2. Normal Read Sequence

- (1) Check Data Ready or not by polling DRDY bit of ST1 register
 - DRDY: Shows Data Ready or not. Not when “0”, Data Ready when “1”.
 - DOR: Shows if any data has been skipped before the current data or not. There are no skipped data when “0”, there are skipped data when “1”.
- (2) Read measurement data

When any of measurement data register (HXL to TMPS) or ST2 register is read, AK09916 judges that data reading is started. When data reading is started, DRDY bit and DOR bit turns to “0”.
- (3) Read ST2 register (required)
 - HOFL: Shows if magnetic sensor is overflowed or not. “0” means not overflowed, “1” means overflowed.

When ST2 register is read, AK09916 judges that data reading is finished. Stored measurement data is protected during data reading and data is not updated. By reading ST2 register, this protection is released. It is required to read ST2 register after data reading.

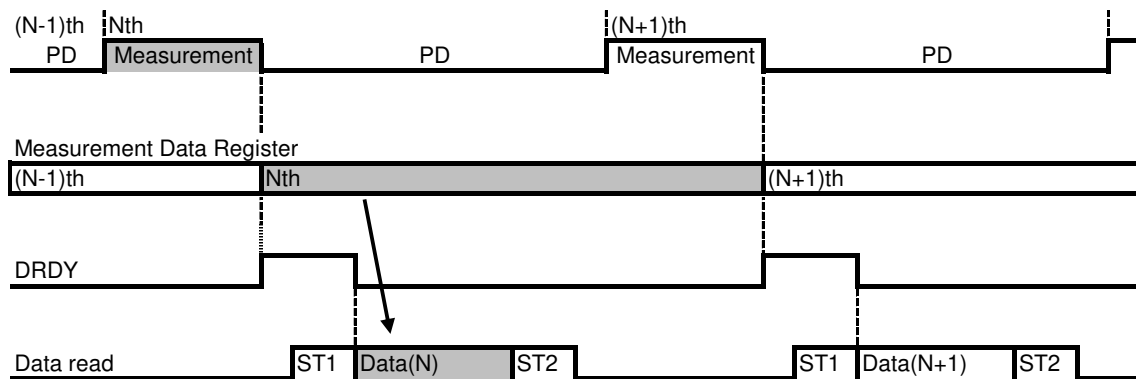

Figure 9.5. Normal read sequence

9.4.3.3. Data Read Start during Measurement

When sensor is measuring (Measurement period), measurement data registers (HXL to TMPS) keep the previous data. Therefore, it is possible to read out data even in measurement period. If data is started to be read during measurement period, previous data is read.

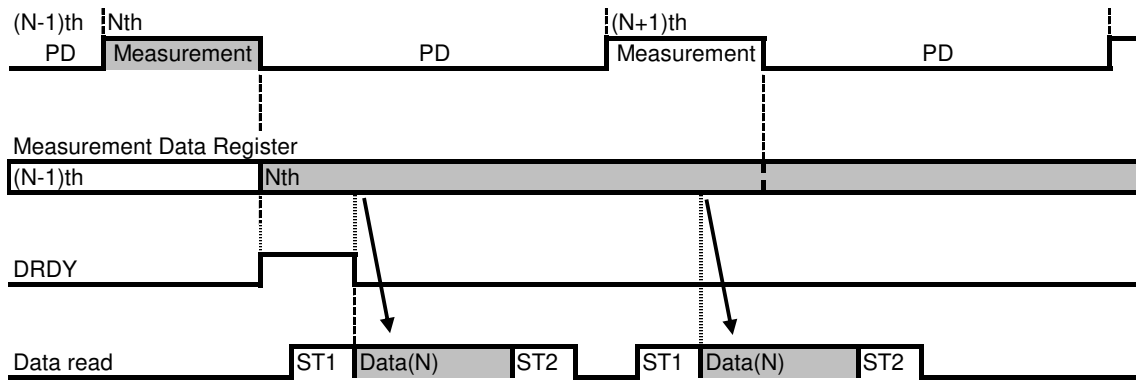

Figure 9.6. Data read start during measurement

9.4.3.4. Data Skip

When Nth data was not read before (N+1)th measurement ends, Data Ready remains until data is read. In this case, a set of measurement data is skipped so that DOR bit turns to “1”.

When data reading started after Nth measurement ended and did not finish reading before (N+1)th measurement ended, Nth measurement data is protected to keep correct data. In this case, a set of measurement data is skipped and not stored so that DOR bit turns to “1”.

In both case, DOR bit turns to “0” at the next start of data reading.

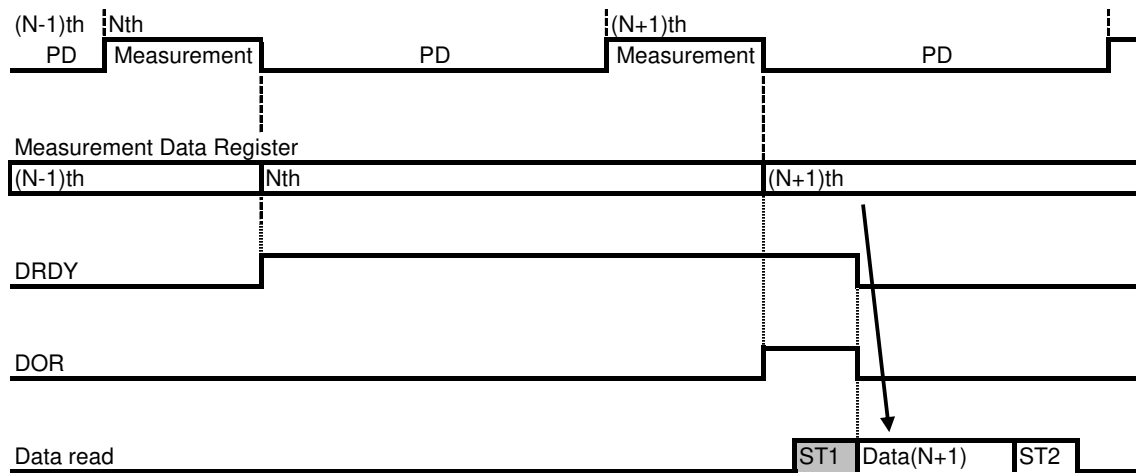

Figure 9.7. Data Skip: When data is not read

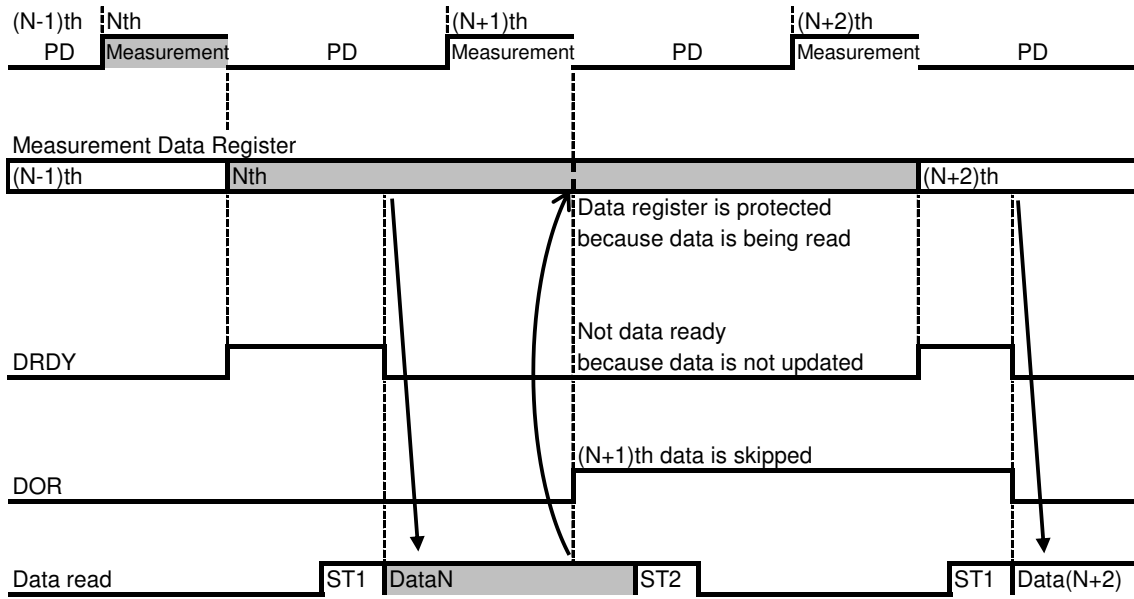

Figure 9.8. Data Skip: When data read has not been finished before the next measurement end

9.4.3.5. End Operation

Set Power-down mode (MODE[4:0] bits = “00000”) to end Continuous measurement mode.

9.4.3.6. Magnetic Sensor Overflow

AK09916 has the limitation for measurement range that the sum of absolute values of each axis should be smaller than 4912 μT . (Note 8)

$$|X| + |Y| + |Z| < 4912 \mu\text{T}$$

When the magnetic field exceeded this limitation, data stored at measurement data are not correct. This is called Magnetic Sensor Overflow.

When magnetic sensor overflow occurs, HOFL bit turns to “1”.

When measurement data register (HXL to HZH) is updated, HOFL bit is updated.

(Note 8) BRG: 0.15 $\mu\text{T}/\text{LSB}$

9.4.4. Self-test Mode

Self-test mode is used to check if the magnetic sensor is working normally.

When Self-test mode (MODE[4:0] bits = "10000") is set, magnetic field is generated by the internal magnetic source and magnetic sensor is measured. Measurement data is stored to measurement data registers (HXL to HZH), then AK09916 transits to Power-down mode automatically.

Data read sequence and functions of read-only registers in Self-test mode is the same as Single measurement mode.

9.4.4.1. Self-test Sequence

- (1) Set Power-down mode. (MODE[4:0] bits = "00000")
- (2) Set Self-test mode. (MODE[4:0] bits = "10000")
- (3) Check Data Ready or not by polling DRDY bit of ST1 register.
When Data Ready, proceed to the next step.
- (4) Read measurement data. (HXL to HZH)

9.4.4.2. Self-test Judgment

When measurement data read by the above sequence is in the range of following table, AK09916 is working normally.

	HX[15:0] bits	HY[15:0] bits	HZ[15:0] bits
Criteria	$-200 \leq HX \leq 200$	$-200 \leq HY \leq 200$	$-1000 \leq HZ \leq -200$

10. Serial Interface

10.1. I²C Bus Interface

The I²C bus interface of AK09916 supports the Standard mode (100 kHz max.) and the Fast mode (400 kHz max.).

10.1.1. Data Transfer

To access AK09916 on the bus, generate a start condition first.

Next, transmit a one-byte slave address including a device address. At this time, AK09916 compares the slave address with its own address. If these addresses match, AK09916 generates an acknowledgement, and then executes READ or WRITE instruction. At the end of instruction execution, generate a stop condition.

10.1.1.1. Change of Data

A change of data on the SDA line must be made during “Low” period of the clock on the SCL line. When the clock signal on the SCL line is “High”, the state of the SDA line must be stable. (Data on the SDA line can be changed only when the clock signal on the SCL line is “Low”.)

During the SCL line is “High”, the state of data on the SDA line is changed only when a start condition or a stop condition is generated.

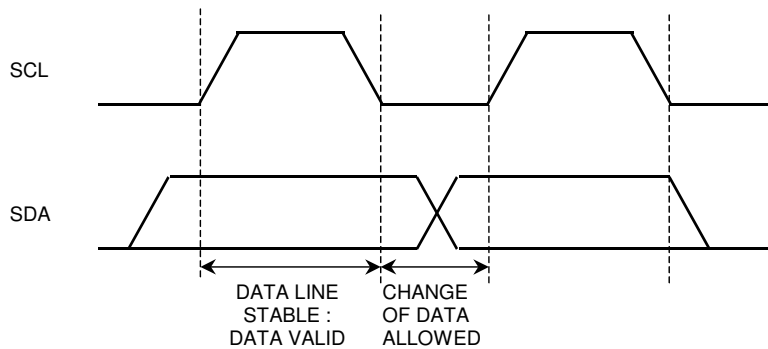

Figure 10.1. Data Change

10.1.1.2. Start/Stop Condition

If the SDA line is driven to “Low” from “High” when the SCL line is “High”, a start condition is generated. Every instruction starts with a start condition.

If the SDA line is driven to “High” from “Low” when the SCL line is “High”, a stop condition is generated. Every instruction stops with a stop condition.

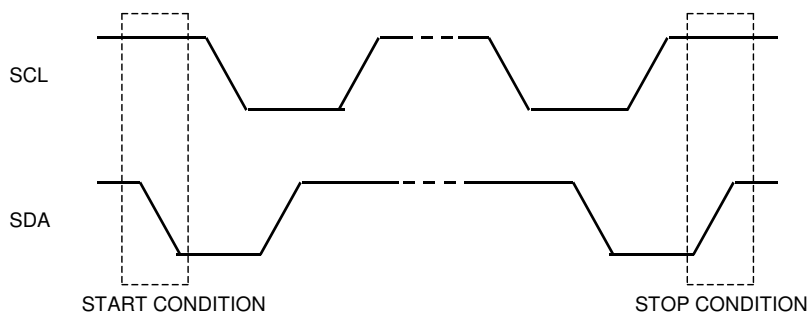

Figure 10.2. Start and Stop Condition

10.1.1.3. Acknowledge

The IC that is transmitting data releases the SDA line (in the “High” state) after sending 1-byte data. The IC that receives the data drives the SDA line to “Low” on the next clock pulse. This operation is referred as acknowledge. With this operation, whether data has been transferred successfully can be checked. AK09916 generates an acknowledge after reception of a start condition and slave address. When a WRITE instruction is executed, AK09916 generates an acknowledge after every byte is received. When a READ instruction is executed, AK09916 generates an acknowledge then transfers the data stored at the specified address. Next, AK09916 releases the SDA line then monitors the SDA line. If a master IC generates an acknowledge instead of a stop condition, AK09916 transmits the 8bit data stored at the next address. If no acknowledge is generated, AK09916 stops data transmission.

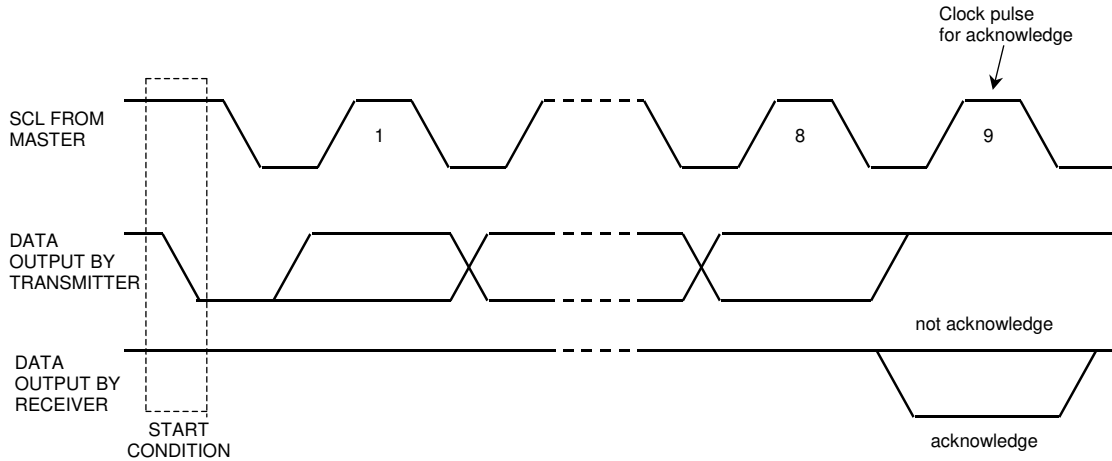

Figure 10.3. Generation of Acknowledge

10.1.1.4. Slave Address

The slave address of AK09916 is 0Ch.

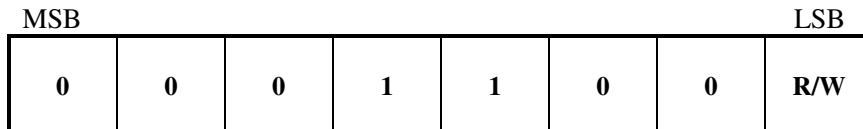

Figure 10.4. Slave Address

The first byte including a slave address is transmitted after a start condition, and an IC to be accessed is selected from the ICs on the bus according to the slave address. When a slave address is transferred, the IC whose device address matches the transferred slave address generates an acknowledge then executes an instruction. The 8th bit (least significant bit) of the first byte is a R/W bit. When the R/W bit is set to “1”, READ instruction is executed. When the R/W bit is set to “0”, WRITE instruction is executed.

10.1.2. WRITE Instruction

When the R/W bit is set to “0”, AK09916 performs write operation.

In write operation, AK09916 generates an acknowledge after receiving a start condition and the first byte (slave address) then receives the second byte. The second byte is used to specify the address of an internal control register and is based on the MSB-first configuration.

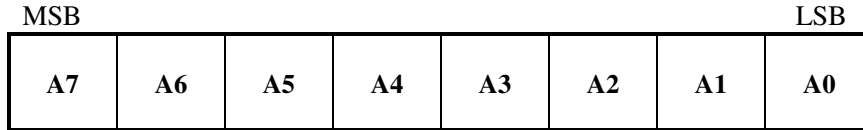

Figure 10.5. Register Address

After receiving the second byte (register address), AK09916 generates an acknowledge then receives the third byte.

The third and the following bytes represent control data. Control data consists of 8 bits and is based on the MSB-first configuration. AK09916 generates an acknowledge after every byte is received. Data transfer always stops with a stop condition generated by the master.

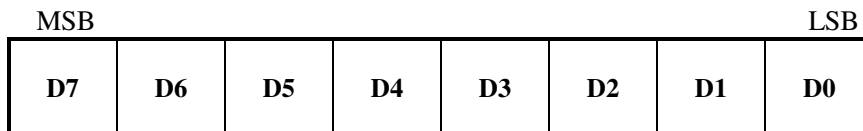

Figure 10.6. Control Data

AK09916 can write multiple bytes of data at a time.

After reception of the third byte (control data), AK09916 generates an acknowledge then receives the next data. If additional data is received instead of a stop condition after receiving one byte of data, the address counter inside the LSI chip is automatically incremented and the data is written at the next address.

The address is incremented from 00h to 18h, from 30h to 32h. When the address is 00h to 18h, the address is incremented 00h → 01h → 02h → 03h → 10h → 11h →... → 18h, and the address goes back to 00h after 18H. When the address is 30h to 32h, the address goes back to 30h after 32h.

Actual data is written only to Read/Write registers (Table 11.2.).

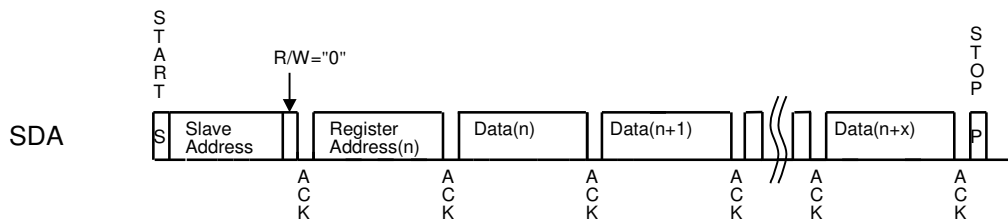

Figure 10.7. WRITE Instruction

10.1.3. READ Instruction

When the R/W bit is set to “1”, AK09916 performs read operation.

If a master IC generates an acknowledge instead of a stop condition after AK09916 transfers the data at a specified address, the data at the next address can be read.

Address can be 00h to 18h, 30h to 32h. When the address is 00h to 18h, the address is incremented 00h → 01h → 02h → 03h → 10h → 11h →... → 18h, and the address goes back to 00h after 18h. When the address is 30h to 32h, the address goes back to 30h after 32h. AK09916 supports current address read and random address read.

10.1.3.1. Current Address READ

AK09916 has an address counter inside the LSI chip. In current address read operation, the data at an address specified by this counter is read.

The internal address counter holds the next address of the most recently accessed address.

For example, if the address most recently accessed (for READ instruction) is address “n”, and a current address read operation is attempted, the data at address “n+1” is read.

In current address read operation, AK09916 generates an acknowledge after receiving a slave address for the READ instruction (R/W bit = “1”). Next, AK09916 transfers the data specified by the internal address counter starting with the next clock pulse, then increments the internal counter by one. If the master IC generates a stop condition instead of an acknowledge after AK09916 transmits one byte of data, the read operation stops.

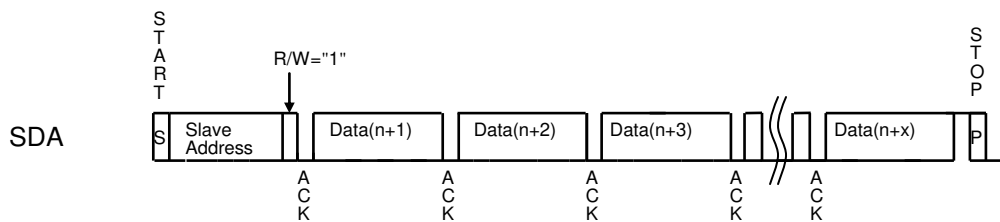

Figure 10.8. Current Address READ

10.1.3.2. Random Address READ

By random address read operation, data at an arbitrary address can be read.

The random address read operation requires to execute WRITE instruction as dummy before a slave address for the READ instruction (R/W bit = “1”) is transmitted. In random read operation, a start condition is first generated then a slave address for the WRITE instruction (R/W bit = “0”) and a read address are transmitted sequentially.

After AK09916 generates an acknowledge in response to this address transmission, a start condition and a slave address for the READ instruction (R/W bit = “1”) are generated again. AK09916 generates an acknowledge in response to this slave address transmission. Next, AK09916 transfers the data at the specified address then increments the internal address counter by one. If the master IC generates a stop condition instead of an acknowledge after data is transferred, the read operation stops.

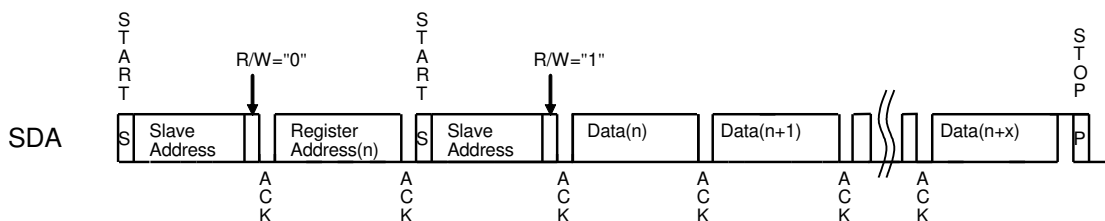

Figure 10.9. Random Address READ

11. Registers

11.1. Description of Registers

AK09916 has registers of 18 addresses as indicated in Table 11.1. . Every address consists of 8 bits data. Data is transferred to or received from the external CPU via the serial interface described previously.

Table 11.1. Register Table

Name	Address	READ/ WRITE	Description	Bit width	Remarks
WIA1	00h	READ	Company ID	8	
WIA2	01h	READ	Device ID	8	
RSV1	02h	READ	Reserved 1	8	
RSV2	03h	READ	Reserved 2	8	
ST1	10h	READ	Status 1	8	Data status
HXL	11h	READ	Measurement Magnetic Data	8	X-axis data
HXH	12h	READ		8	
HYL	13h	READ		8	Y-axis data
HYH	14h	READ		8	
HZL	15h	READ		8	Z-axis data
HZH	16h	READ		8	
TMPS	17h	READ	Dummy	8	Dummy
ST2	18h	READ	Status 2	8	Data status
CNTL1	30h	READ/ WRITE	Dummy	8	Dummy
CNTL2	31h	READ/ WRITE	Control 2	8	Control settings
CNTL3	32h	READ/ WRITE	Control 3	8	Control settings
TS1	33h	READ/ WRITE	Test	8	DO NOT ACCESS
TS2	34h	READ/ WRITE	Test	8	DO NOT ACCESS

Addresses 00h to 18h, 30h to 32h are compliant with automatic increment function of serial interface respectively. In other modes, read data is not correct. When the address is in 00h to 18h, the address is incremented 00h → 01h → 02h → 03h → 10h → 11h →... → 18h, and the address goes back to 00h after 18h. When the address is in 30h to 32h, the address goes back to 30h after 32h.

11.2. Register Map

Table 11.2. Register Map

Addr.	Register name	D7	D6	D5	D4	D3	D2	D1	D0
Read-only register									
00h	WIA1	0	1	0	0	1	0	0	0
01h	WIA2	0	0	0	0	1	0	0	1
02h	RSV1	RSV17	RSV16	RSV15	RSV14	RSV13	RSV12	RSV11	RSV10
03h	RSV2	RSV27	RSV26	RSV25	RSV24	RSV23	RSV22	RSV21	RSV20
10h	ST1	0	0	0	0	0	0	DOR	DRDY
11h	HXL	HX7	HX6	HX5	HX4	HX3	HX2	HX1	HX0
12h	HXH	HX15	HX14	HX13	HX12	HX11	HX10	HX9	HX8
13h	HYL	HY7	HY6	HY5	HY4	HY3	HY2	HY1	HY0
14h	HYH	HY15	HY14	HY13	HY12	HY11	HY10	HY9	HY8
15h	HZL	HZ7	HZ6	HZ5	HZ4	HZ3	HZ2	HZ1	HZ0
16h	HZH	HZ15	HZ14	HZ13	HZ12	HZ11	HZ10	HZ9	HZ8
17h	TMPS	0	0	0	0	0	0	0	0
18h	ST2	0	RSV30	RSV29	RSV28	HOFL	0	0	0
Read/Write register									
30h	CNTL1	0	0	0	0	0	0	0	0
31h	CNTL2	0	0	0	MODE4	MODE3	MODE2	MODE1	MODE0
32h	CNTL3	0	0	0	0	0	0	0	SRST
33h	TS1	-	-	-	-	-	-	-	-
34h	TS2	-	-	-	-	-	-	-	-

When VDD is turned ON, POR function works and all registers of AK09916 are initialized. TS1 and TS2 are test registers for shipment test. Do not access these registers.

11.3. Detailed Description of Register

11.3.1. WIA: Who I Am

Addr.	Register name	D7	D6	D5	D4	D3	D2	D1	D0
Read-only register									
00h	WIA1	0	1	0	0	1	0	0	0
01h	WIA2	0	0	0	0	1	0	0	1

WIA1[7:0] bits: Company ID of AKM. It is described in one byte and fixed value.

48h: fixed

WIA2[7:0] bits: Device ID of AK09916. It is described in one byte and fixed value.

09h: fixed

11.3.2. RSV: Reserved

Addr.	Register name	D7	D6	D5	D4	D3	D2	D1	D0
Read-only register									
02h	RSV1	RSV17	RSV16	RSV15	RSV14	RSV13	RSV12	RSV11	RSV10
03h	RSV2	RSV27	RSV26	RSV25	RSV24	RSV23	RSV22	RSV21	RSV20

RSV1[7:0] bits/ RSV2[7:0] bits: Reserved register for AKM.

11.3.3. ST1: Status 1

Addr.	Register name	D7	D6	D5	D4	D3	D2	D1	D0
Read-only register									
10h	ST1	0	0	0	0	0	0	DOR	DRDY
Reset		0	0	0	0	0	0	0	0

DRDY: Data Ready

“0”: Normal

“1”: Data is ready

DRDY bit turns to “1” when data is ready in Single measurement mode, Continuous measurement mode 1, 2, 3, 4 or Self-test mode. It returns to “0” when any one of ST2 register or measurement data register (HXL to TMPS) is read.

DOR: Data Overrun

“0”: Normal

“1”: Data overrun

DOR bit turns to “1” when data has been skipped in Continuous measurement mode 1, 2, 3, 4. It returns to “0” when any one of ST2 register or measurement data register (HXL to TMPS) is read.

11.3.4. HXL to HZH: Measurement Magnetic data

Addr.	Register name	D7	D6	D5	D4	D3	D2	D1	D0
Read-only register									
11h	HXL	HX7	HX6	HX5	HX4	HX3	HX2	HX1	HX0
12h	HXH	HX15	HX14	HX13	HX12	HX11	HX10	HX9	HX8
13h	HYL	HY7	HY6	HY5	HY4	HY3	HY2	HY1	HY0
14h	HYH	HY15	HY14	HY13	HY12	HY11	HY10	HY9	HY8
15h	HZL	HZ7	HZ6	HZ5	HZ4	HZ3	HZ2	HZ1	HZ0
16h	HZH	HZ15	HZ14	HZ13	HZ12	HZ11	HZ10	HZ9	HZ8
Reset		0	0	0	0	0	0	0	0

Measurement data of magnetic sensor X-axis/Y-axis/Z-axis

HXL[7:0] bits: X-axis measurement data lower 8-bit

HXH[15:8] bits: X-axis measurement data higher 8-bit

HYL[7:0] bits: Y-axis measurement data lower 8-bit

HYH[15:8] bits: Y-axis measurement data higher 8-bit

HZL[7:0] bits: Z-axis measurement data lower 8-bit

HZH[15:8] bits: Z-axis measurement data higher 8-bit

Measurement data is stored in two's complement and Little Endian format. Measurement range of each axis is -32752 to 32752 in 16-bit output.

Table 11.3. Measurement magnetic data format

Measurement data (each axis) [15:0] bits			Magnetic flux density [μ T]
Two's complement	Hex	Decimal	
0111 1111 1111 0000	7FF0	32752	4912(max.)
0000 0000 0000 0001	0001	1	0.15
0000 0000 0000 0000	0000	0	0
1111 1111 1111 1111	FFFF	-1	-0.15
1000 0000 0001 0000	8010	-32752	-4912(min.)

11.3.5. TMPS: Dummy

Addr.	Register name	D7	D6	D5	D4	D3	D2	D1	D0
Read-only register									
17h	TMPS	0	0	0	0	0	0	0	0
Reset		0	0	0	0	0	0	0	0

TMPS[7:0] bits: Dummy register.

11.3.6. ST2: Status 2

Addr.	Register name	D7	D6	D5	D4	D3	D2	D1	D0
Read-only register									
18h	ST2	0	RSV30	RSV29	RSV28	HOFL	0	0	0
Reset		0	0	0	0	0	0	0	0

ST2[6:4] bits: Reserved register for AKM.

HOFL: Magnetic sensor overflow

“0”: Normal

“1”: Magnetic sensor overflow occurred

In Single measurement mode, Continuous measurement mode 1, 2, 3, 4, and Self-test mode, magnetic sensor may overflow even though measurement data register is not saturated. In this case, measurement data is not correct and HOFL bit turns to “1”. When measurement data register is updated, HOFL bit is updated. Refer to 9.4.3.6 for detailed information.

ST2 register has a role as data reading end register, also. When any of measurement data register (HXL to TMPS) is read in Continuous measurement mode 1, 2, 3, 4, it means data reading start and taken as data reading until ST2 register is read. Therefore, when any of measurement data is read, be sure to read ST2 register at the end.

11.3.7. CNTL1: Dummy

Addr.	Register name	D7	D6	D5	D4	D3	D2	D1	D0
Read/Write register									
30h	CNTL1	0	0	0	0	0	0	0	0
Reset		0	0	0	0	0	0	0	0

CNTL1[7:0] bits: Dummy register.

11.3.8. CNTL2: Control 2

Addr.	Register name	D7	D6	D5	D4	D3	D2	D1	D0
Read/Write register									
31h	CNTL2	0	0	0	MODE4	MODE3	MODE2	MODE1	MODE0
Reset		0	0	0	0	0	0	0	0

MODE[4:0] bits: Operation mode setting

“00000”: Power-down mode

“00001”: Single measurement mode

“00010”: Continuous measurement mode 1

“00100”: Continuous measurement mode 2

“00110”: Continuous measurement mode 3

“01000”: Continuous measurement mode 4

“10000”: Self-test mode

Other code settings are prohibited

When each mode is set, AK09916 transits to the set mode. Refer to 9.3 for detailed information.

11.3.9. CNTL3: Control 3

Addr.	Register name	D7	D6	D5	D4	D3	D2	D1	D0
Read/Write register									
32h	CNTL3	0	0	0	0	0	0	0	SRST
Reset		0	0	0	0	0	0	0	0

SRST: Soft reset

“0”: Normal

“1”: Reset

When “1” is set, all registers are initialized. After reset, SRST bit turns to “0” automatically.

11.3.10. TS1, TS2: Test

Addr.	Register name	D7	D6	D5	D4	D3	D2	D1	D0
Read/Write register									
33h	TS1	-	-	-	-	-	-	-	-
34h	TS2	-	-	-	-	-	-	-	-
Reset		0	0	0	0	0	0	0	0

TS1 and TS2 registers are AKM internal test register. Do not access these registers.

12. Example of Recommended External Connection

