



Chipsmall Limited consists of a professional team with an average of over 10 year of expertise in the distribution of electronic components. Based in Hongkong, we have already established firm and mutual-benefit business relationships with customers from,Europe,America and south Asia,supplying obsolete and hard-to-find components to meet their specific needs.

With the principle of "Quality Parts,Customers Priority,Honest Operation,and Considerate Service",our business mainly focus on the distribution of electronic components. Line cards we deal with include Microchip,ALPS,ROHM,Xilinx,Pulse,ON,Everlight and Freescale. Main products comprise IC,Modules,Potentiometer,IC Socket,Relay,Connector.Our parts cover such applications as commercial,industrial, and automotives areas.

We are looking forward to setting up business relationship with you and hope to provide you with the best service and solution. Let us make a better world for our industry!



Contact us

Tel: +86-755-8981 8866 Fax: +86-755-8427 6832

Email & Skype: info@chipsmall.com Web: www.chipsmall.com

Address: A1208, Overseas Decoration Building, #122 Zhenhua RD., Futian, Shenzhen, China





AK2929

Zero Drift operational amplifiers

Feature

AK2929 is the dual channel CMOS operational amplifiers which is available to output with very low input offset voltage ($\pm 1.0\mu\text{V}$) and near zero input offset drift.

It's operated with very small current consumptions, $700\mu\text{A}$ typ./ch (VDD: $3.2\text{V} \pm 5\%$), which is available to operate full swing signals in output.

AK2929 is appropriated to Sensor Pre Amp. applications.

- Low Voltage, Single Supply Operation : $2.7\text{V} - 5.5\text{V}$
- Very Low Input Offset Voltage : $\pm 1.0\mu\text{V}$ typ.
- Near Zero Drift over time and temperature : $\pm 2.0\text{nV}/^\circ\text{C}$ typ.
- Full Swing Outputs to $10\text{k}\Omega$ Load
- Power Supply Current : $700\mu\text{A}$ typ./ch (VDD: $3.2\text{V} \pm 5\%$, No Load)
- Gain Bandwidth : 2MHz typ.
- Package : TMSOP8

Part Name	Channel Number	Package
AK2929T	2	TMSOP8

Pin Location

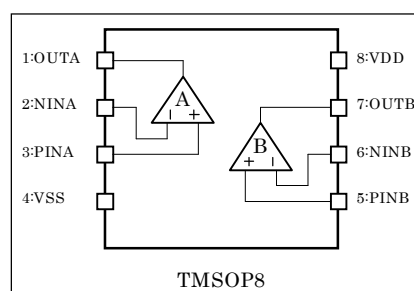

(AK2929T)

Pin Function Descriptions

Pin number	Name	I/O note)	Function
1	OUTA	AO	Amplifier A Output
2	NINA	AI	Amplifier A Inverted Input
3	PINA	AI	Amplifier A No Inverted Input
4	VSS	PWR	Power Supply Ground
5	PINB	AI	Amplifier B No Inverted Input
6	NINB	AI	Amplifier B Inverted Input
7	OUTB	AO	Amplifier B Output
8	VDD	PWR	Positive Power Supply

Note)

PWR : Power Supply
 AI : Analog Input
 AO : Analog Output

Absolute Maximum Ratings

VSS=0V ; Note

Parameter	Symbol	Min	Max	Units
Supply Voltage	VDD	-0.3	6.5	V
Input Voltage	V _{TD}	-0.3	VDD + 0.3	V
Input Current	I _{IN}	-10	+10	mA
Storage Temperature Range	T _{stg}	-55	150	°C

Note : All voltage with respect to ground

WARNING :

Operational at or beyond these limits may result in permanent damage to the device. Normal operation is not guaranteed at these extremes.

Recommended Operating Conditions

Parameter	Symbol	Min.	Typ.	Max.	Units	Conditions
Operating Temperature Range	T _a	-40		85	°C	
Supply Voltage	VDD	2.7		5.5	V	
Power Supply Current	I _{dd1}		0.7	1.1	mA/ch.	VDD=3.2V +/- 5%, No Load

*We assume no responsibility for the usage beyond the conditions in this datasheet.

Electrical Characteristics

 DC Characteristics

VDD:5V, Ta:-40 to 85°C, unless otherwise noted

Parameter	Min.	Typ.	Max.	Units	Conditions
Input Voltage Offset		+/- 1	+/- 10	μV	
Input Voltage Offset Drift		+/- 2	+/- 100	nV/°C	
Input Bias Current		+/- 20		pA	
Input Common Mode Range		0.0 – VDD-0.2		V	
Output Voltage Swing		0.03 – VDD-0.03		V	RL ≥10kΩ connected to VDD/2
Common Mode Rejection Ratio	90	130		dB	
Power Supply Rejection Ratio	100	130		dB	
Large Signal Voltage Gain	100	130		dB	RL ≥10kΩ connected to VDD/2
Short Circuit Current		+/- 40		mA	
Output Current		+/- 20		mA	

 AC Characteristics

VDD:5V, Ta:-40 to 85°C, unless otherwise noted

Parameter	Min.	Typ.	Max.	Units	Conditions
Gain Bandwidth		2		MHz	Av:1V/V
Slew Rate		1		V/μs	Av:1V/V
Input Voltage Noise		25		nVrms /√Hz	f:1kHz
	0.1 – 10Hz	0.5		μVpp	
	0.1 – 1Hz	0.2		μVpp	
Overload Recovery Time		0.05		msec	Av:1V/V
Input Capacitance	Differential	1.5		pF	
	Common Mode	12		PF	
Maximum Capacitance Loads			150	pF	

Typical Operating Characteristics

□ Supply Current vs. Temperature
($V_{in}: 1/2V_{DD}$)

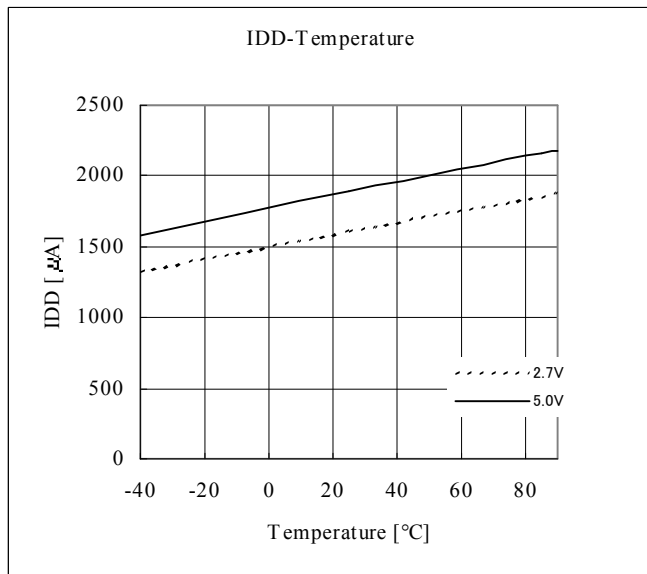

□ Supply Current vs. Supply Voltage
($V_{in}: 1/2V_{DD}$)

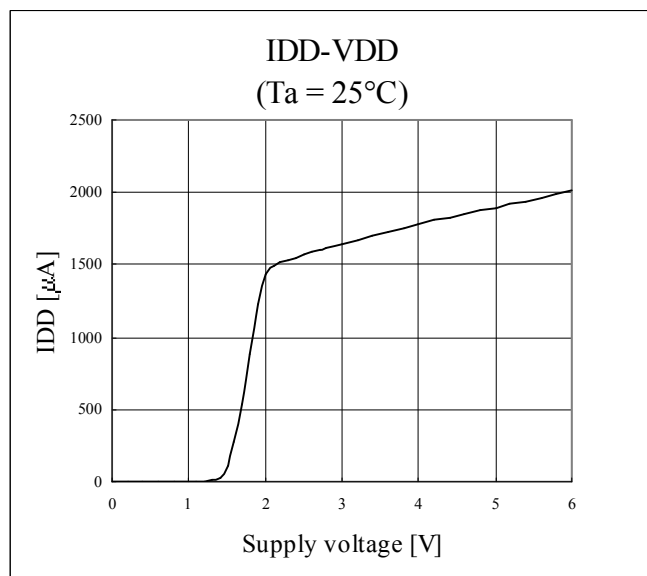

□ Output voltage vs. Load current
(VDD=2.7V, Ta=25°C)

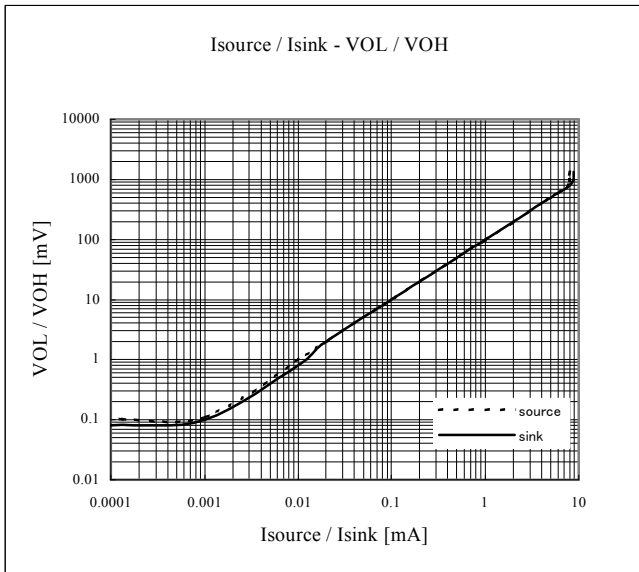

□ Output voltage vs. Load current
(VDD=5V, Ta=25°C)

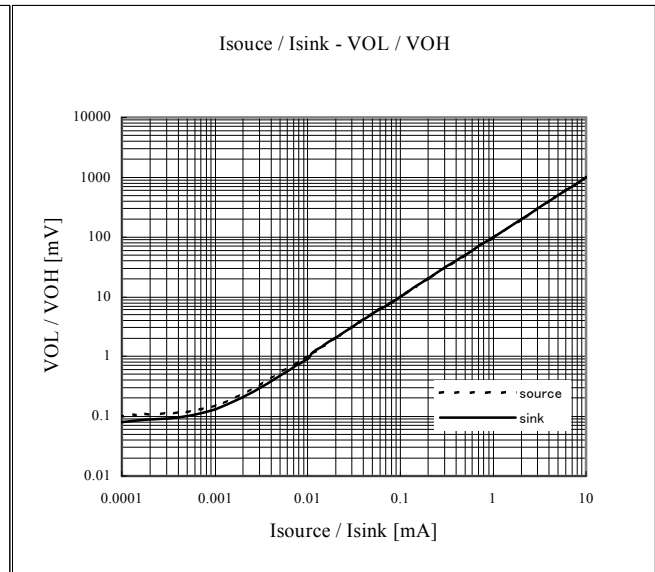

□ Closed loop gain vs. Frequency
(VDD=2.7V, Ta=25°C)

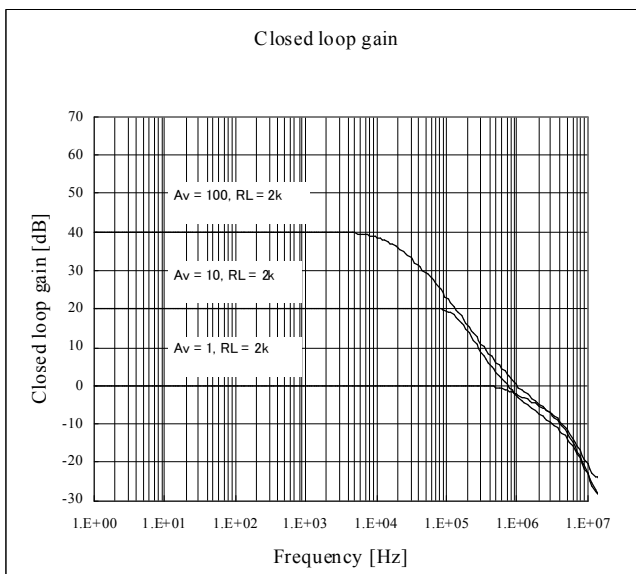

□ Closed loop gain vs. Frequency
(VDD=5V, Ta=25°C)

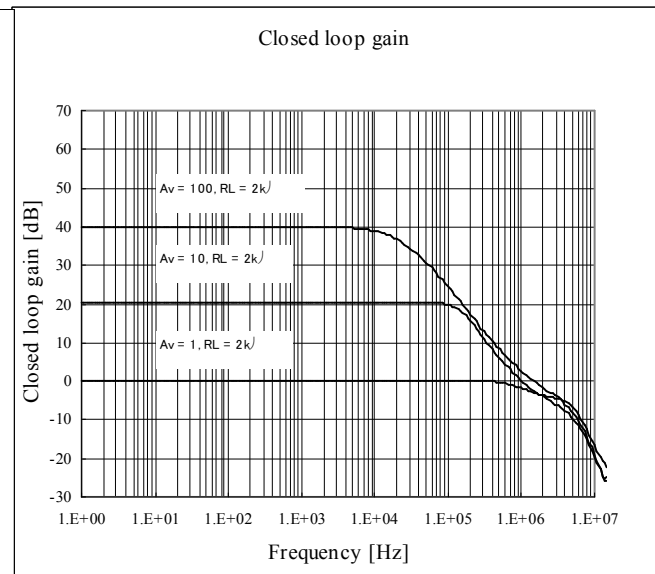

□ Open loop gain and Phase vs. Frequency
(VDD=2.7V, Ta=25°C)

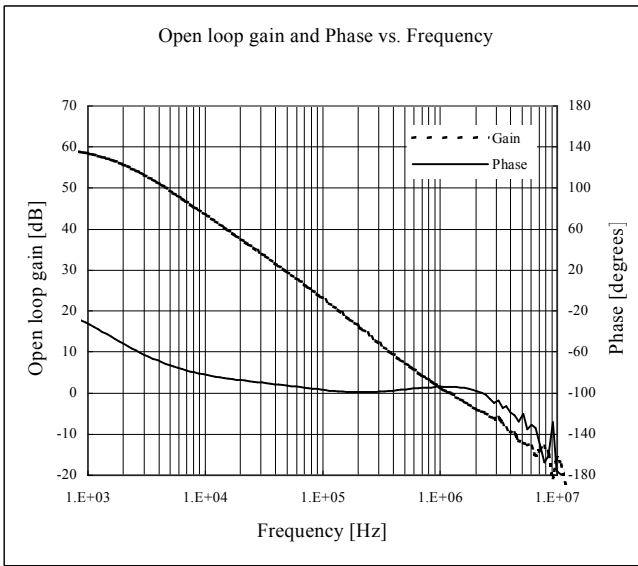

□ Open loop gain and Phase vs. Frequency
(VDD=5V, Ta=25°C)

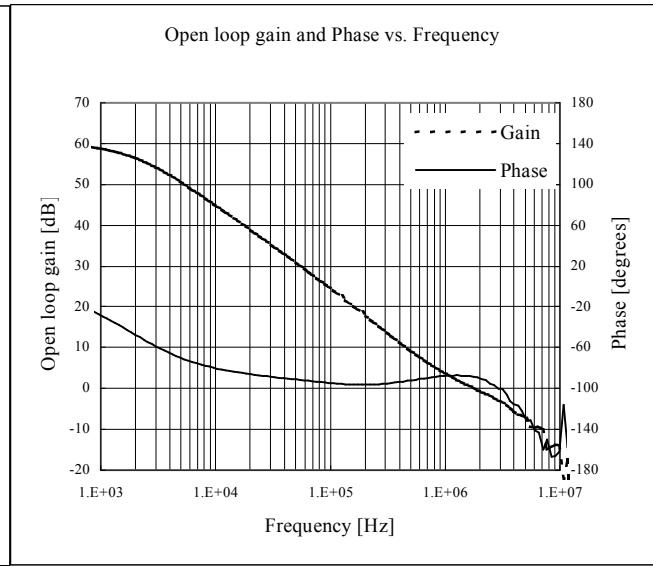

□ Output impedance vs. Frequency
(VDD=2.7V, Ta=25°C)

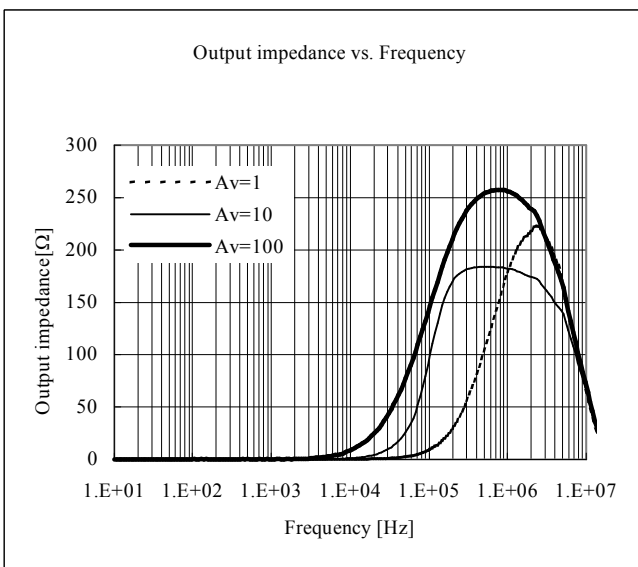

□ Output impedance vs. Frequency
(VDD=5V, Ta=25°C)

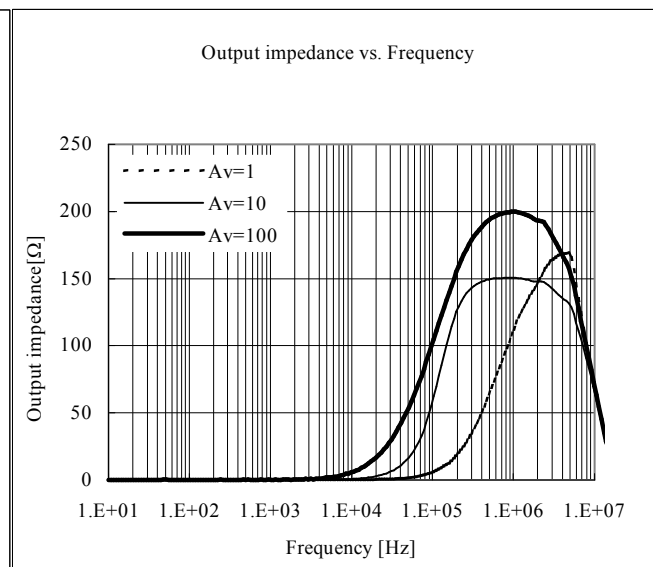

- Large signal transient response
(VDD/VSS = +1.35V/- 1.35V,
Ta = 25°C, CL = 150pF)

- Large signal transient response
(VDD/VSS = +2.5V/-2.5V
Ta = 25°C, CL = 150pF)

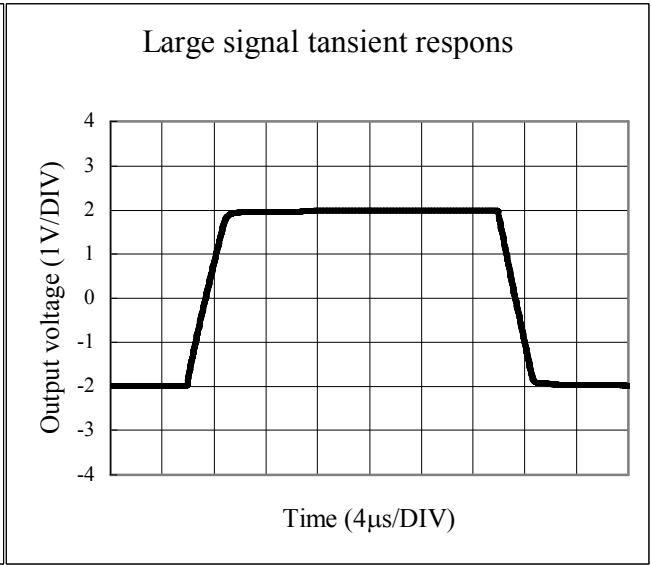
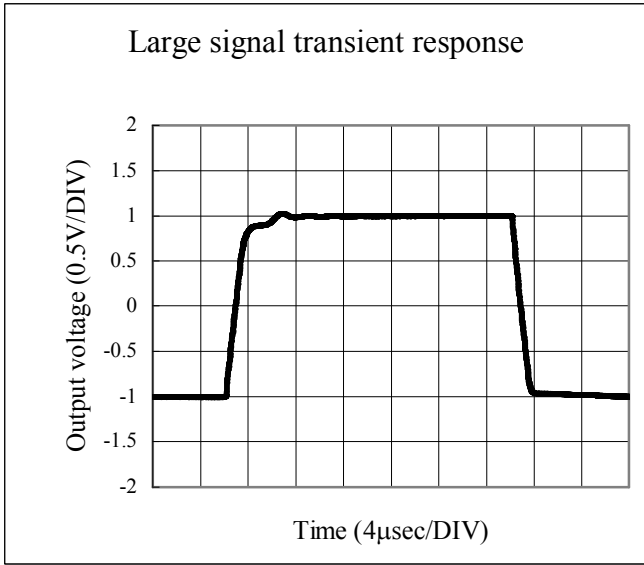

- Small signal transient response
(VDD/VSS = +1.35V/- 1.35V,
Ta = 25°C, CL = 150pF)

- Small signal transient response
(VDD/VSS = +2.5V/-2.5V
Ta = 25°C, CL = 150pF)

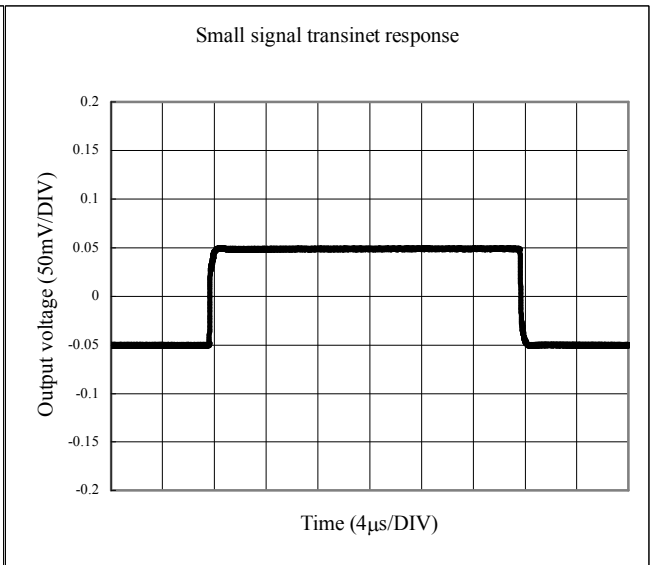
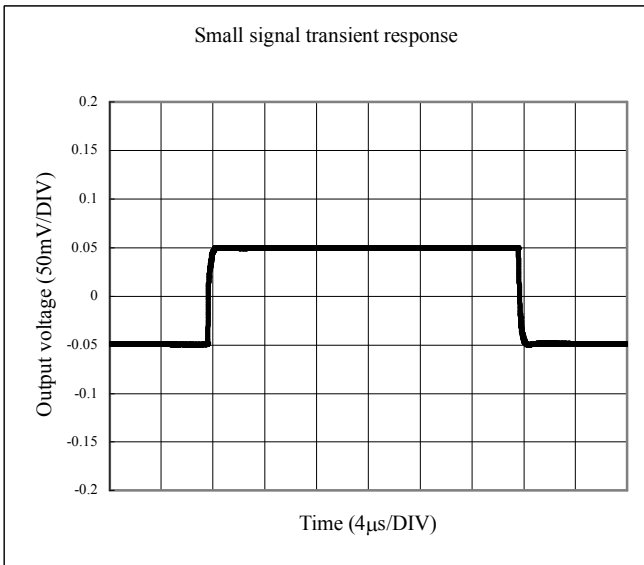

□ Small signal overshoot vs. Load Capacitance
(VDD=2.7V, Ta=25°C)

□ Small signal overshoot vs. Load Capacitance
(VDD=5V, Ta=25°C)

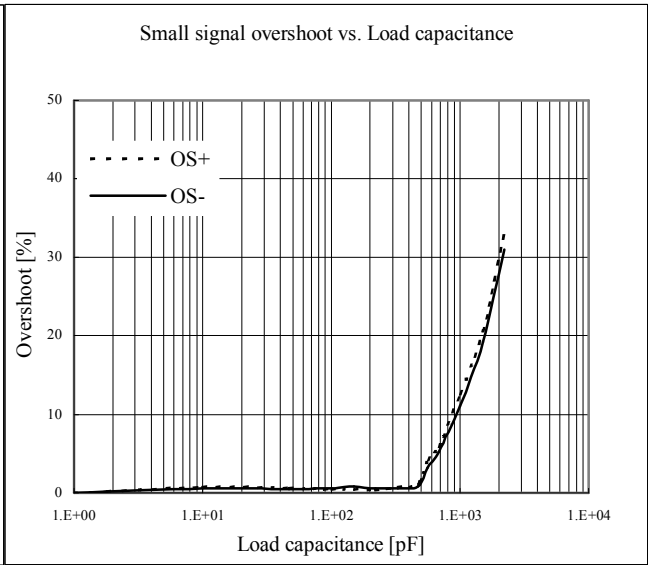
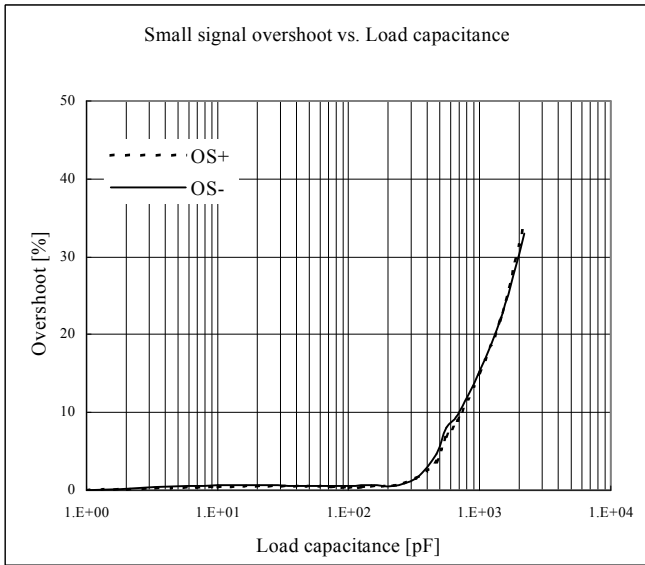

□ Positive overvoltage recovery
(VDD/VSS = +2.5V/-2.5V, Ta = 25°C)

□ Negative overvoltage recovery
(VDD/VSS = +2.5V/-2.5V, Ta = 25°C)

Positive overvoltage recovery

Negative overvoltage recovery

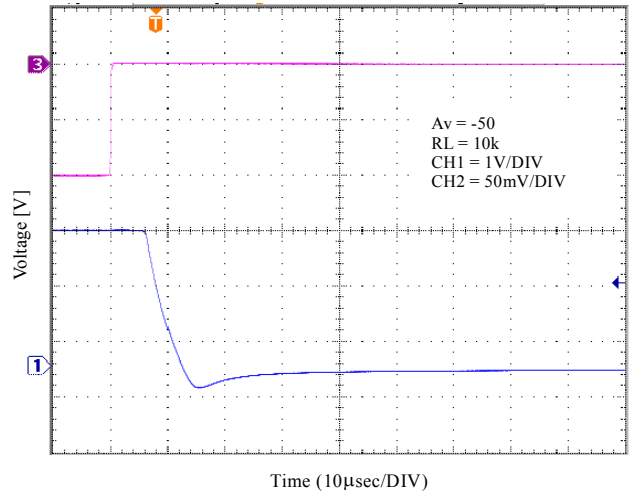
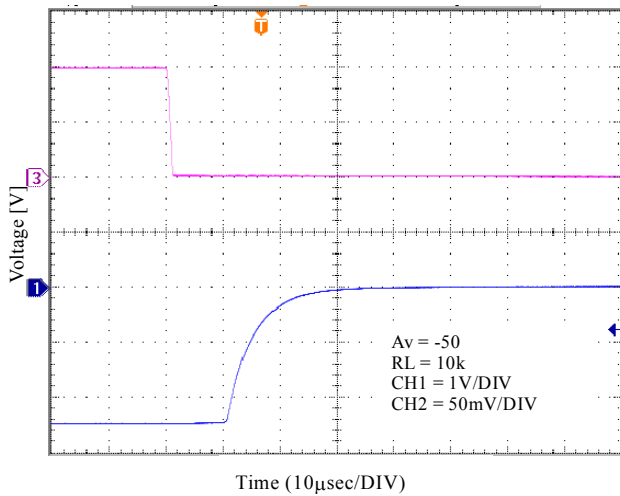

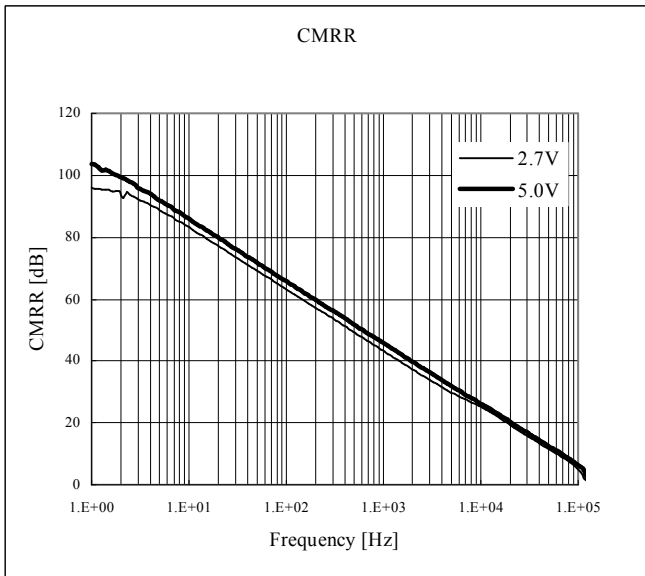

□ Common Mode Rejection Ratio vs. Frequency

□ Power Supply Rejection Ratio vs. Frequency
(VDD=2.7V, Ta=25°C)

□ Power Supply Rejection Ratio vs. Frequency
(VDD=5V, Ta=25°C)

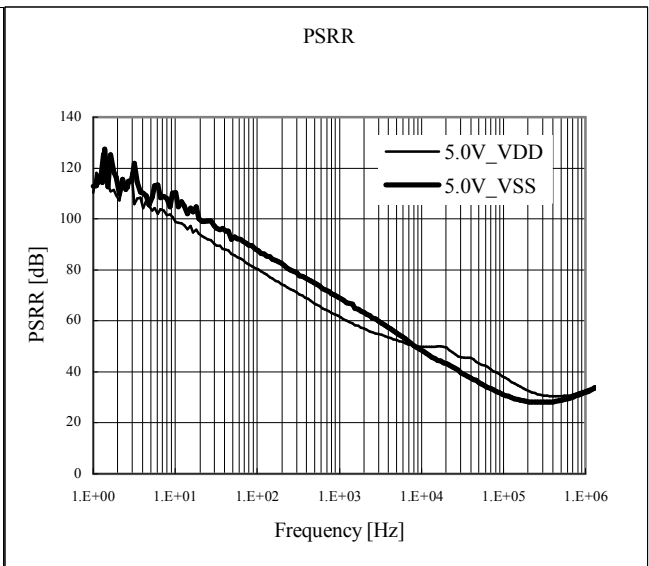
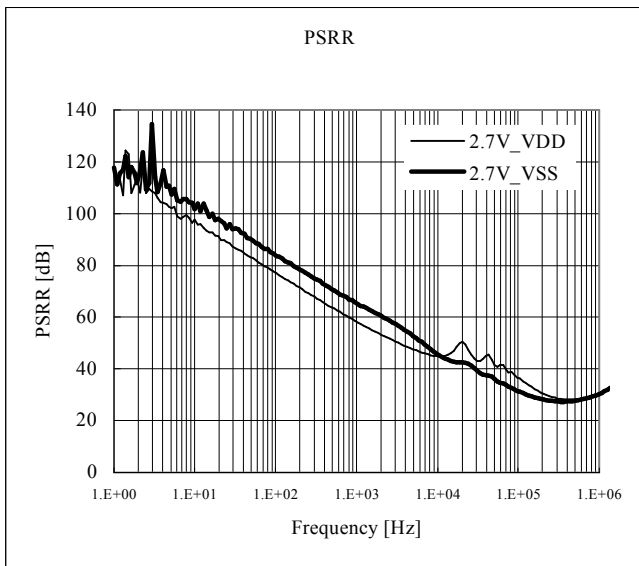

□ Power Supply Rejection Ratio vs. Temperature
(VDD=5V)

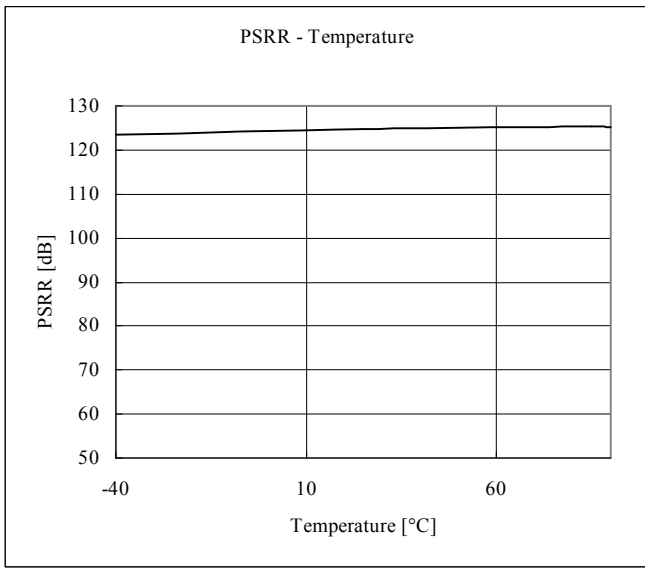

□ Maximum output swing vs. Frequency
(VDD=2.7V, Ta=25°C, Av = 1, RL = 10kΩ)

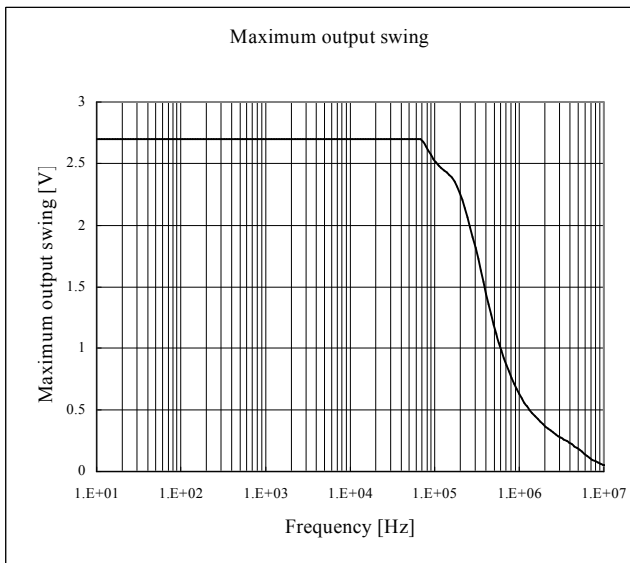

□ Maximum output swing vs. Frequency
(VDD=5V, Ta=25°C, Av = 1, RL = 10kΩ)

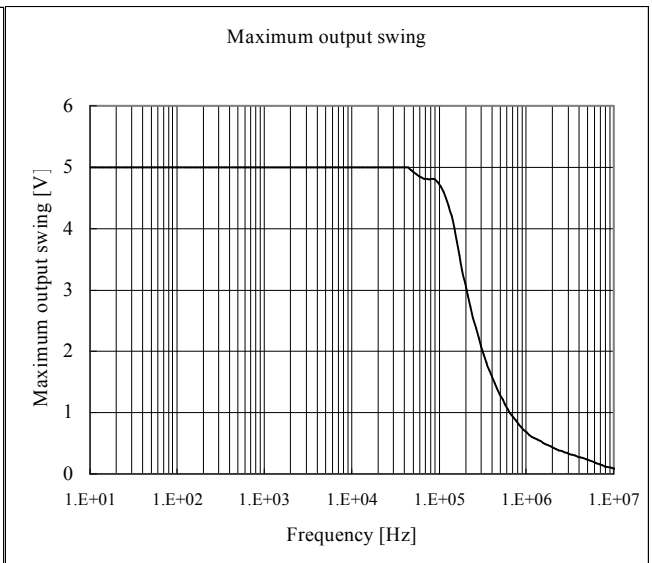

□ Voltage noise density
(VDD=2.7V, Ta=25°C, f=0~2.5kHz)

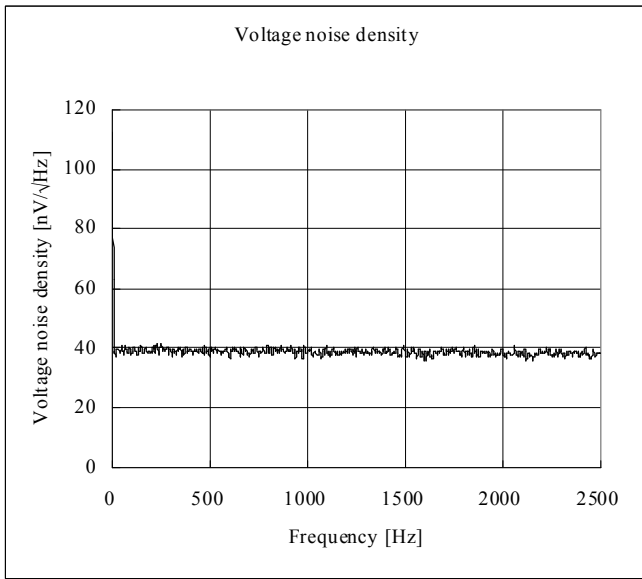

□ Voltage noise density
(VDD=5V, Ta=25°C, f=0~2.5kHz)

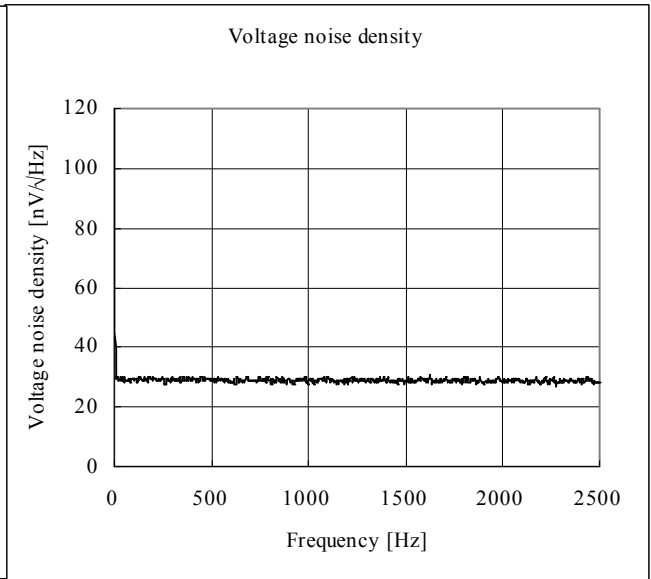

□ Voltage noise density
(VDD=2.7V, Ta=25°C, f=0~20kHz)

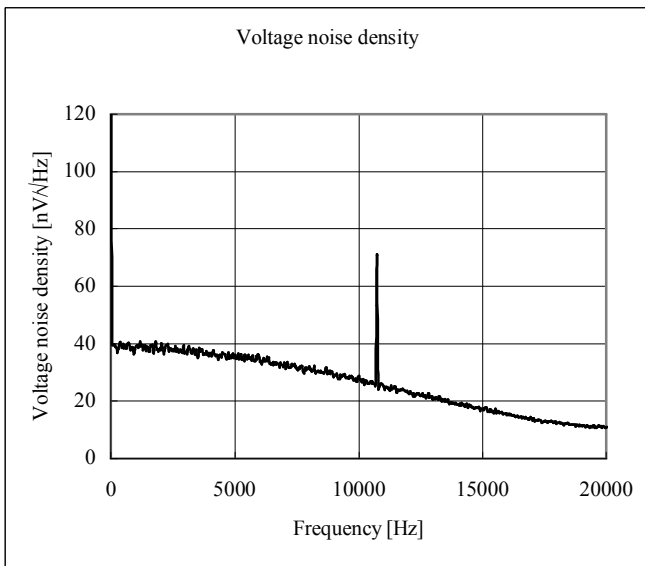

□ Voltage noise density
(VDD=5V, Ta=25°C, f=0~20kHz)

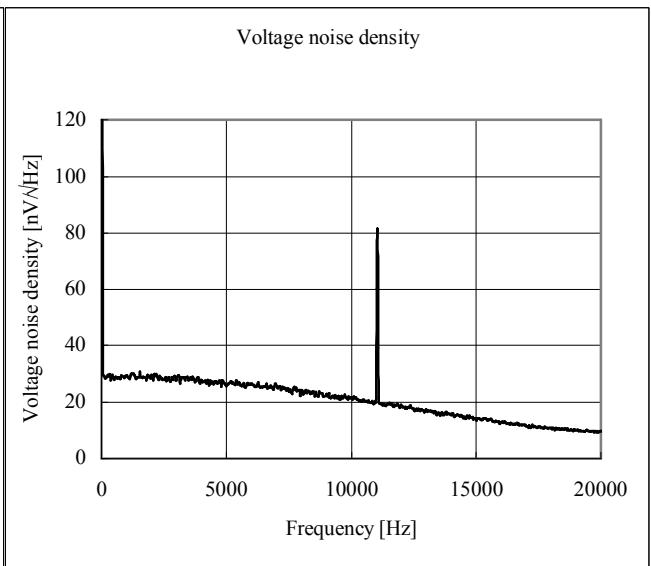

- Voltage noise density
(VDD=5V, Ta=25°C, f=1~10kHz)

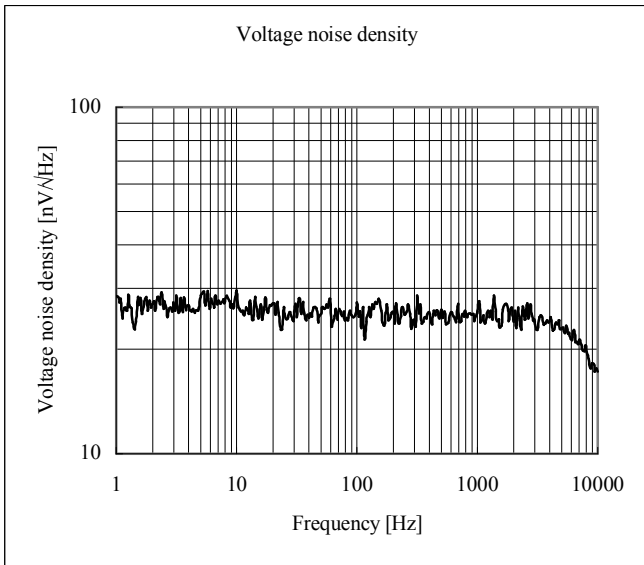

- Voltage noise
(VDD=2.7V, Ta=25°C, f=0.1~10Hz)

0.1Hz to 10Hz Noise

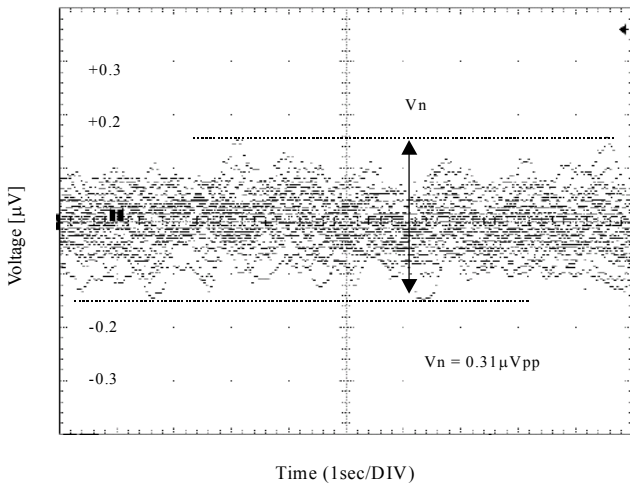

- Voltage noise
(VDD=5V, Ta=25°C, f=0.1~10Hz)

0.1Hz to 10Hz Noise

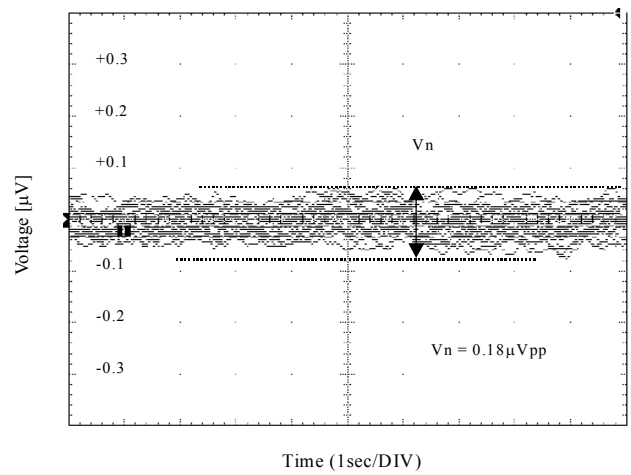

□ Output short-circuit current vs. Temperature
(VDD=2.7V, Ta=-40 to 85°C)

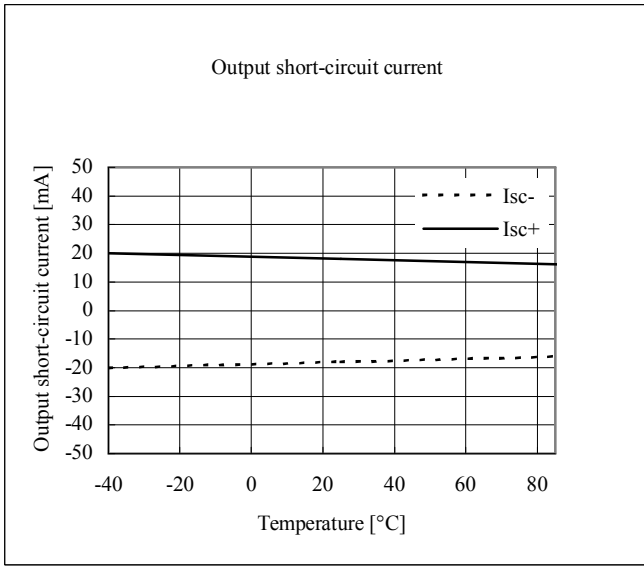

□ Maximum output swing vs. Frequency
(VDD=5V, Ta=25°C, Ta=-40 to 85°C)

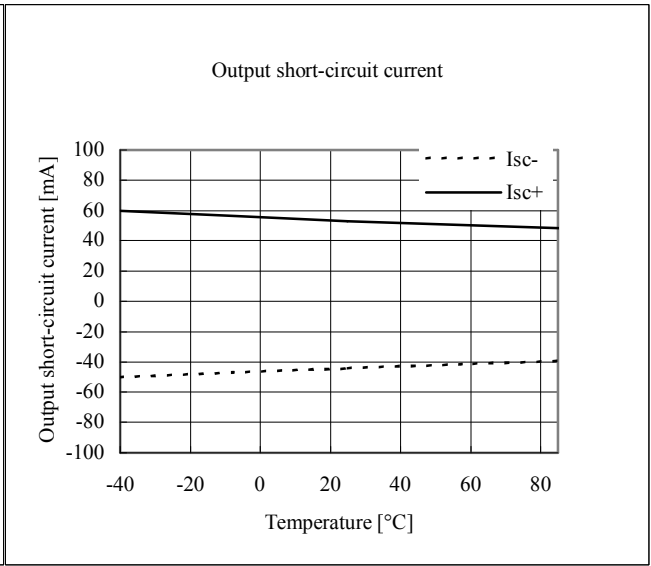

□ Input offset voltage drift(VDD=5V, Ta=25°C, Ta=-40 to 85°C)

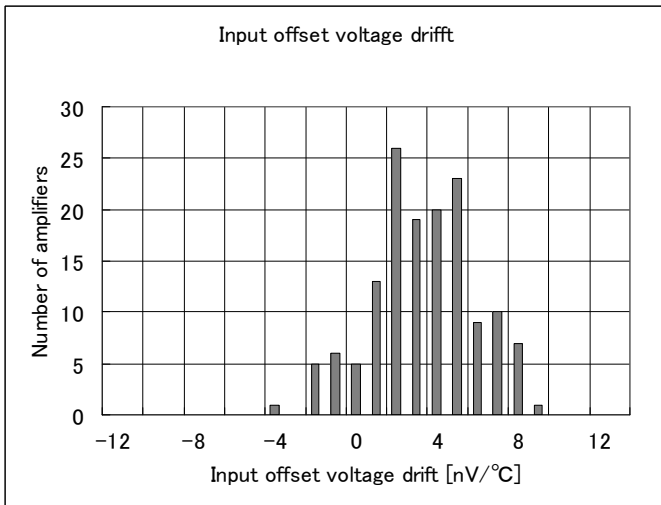

Package

1. Marking

1.1 TMSOP8

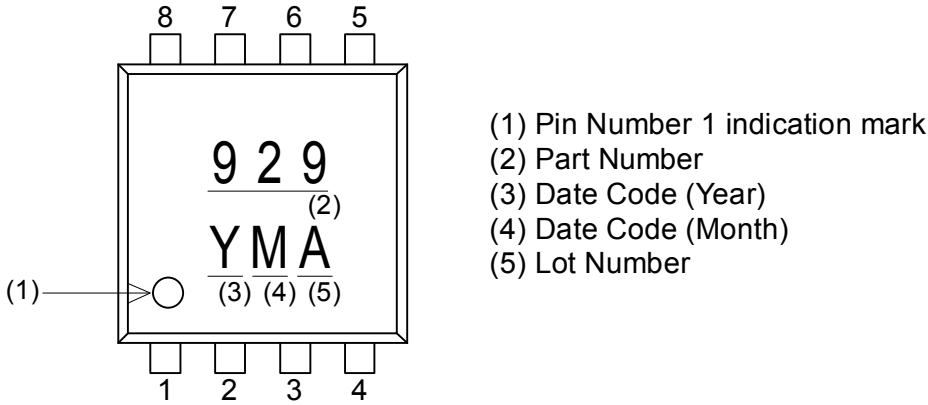

2. Outline Dimensions

2.1 TMSOP8 Package Outline

(UNIT:mm)

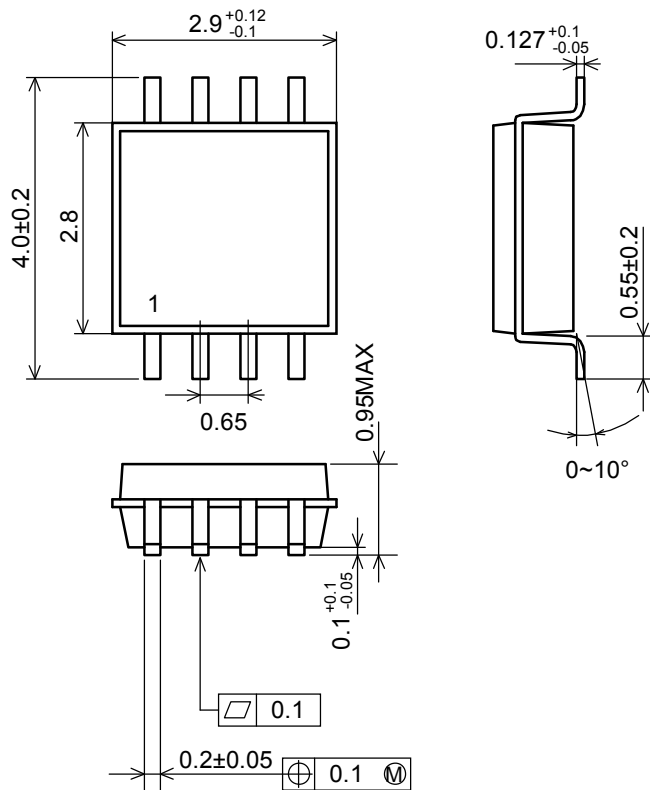

IMPORTANT NOTICE

- These products and their specifications are subject to change without notice. When you consider any use or application of these products, please make inquiries the sales office of Asahi Kasei Microdevices Corporation (AKM) or authorized distributors as to current status of the products.
- Descriptions of external circuits, application circuits, software and other related information contained in this document are provided only to illustrate the operation and application examples of the semiconductor products. You are fully responsible for the incorporation of these external circuits, application circuits, software and other related information in the design of your equipments. AKM assumes no responsibility for any losses incurred by you or third parties arising from the use of these information herein. AKM assumes no liability for infringement of any patent, intellectual property, or other rights in the application or use of such information contained herein.
- Any export of these products, or devices or systems containing them, may require an export license or other official approval under the law and regulations of the country of export pertaining to customs and tariffs, currency exchange, or strategic materials.
- AKM products are neither intended nor authorized for use as critical components^{Note1)} in any safety, life support, or other hazard related device or system^{Note2)}, and AKM assumes no responsibility for such use, except for the use approved with the express written consent by Representative Director of AKM. As used here:
 - Note1) A critical component is one whose failure to function or perform may reasonably be expected to result, whether directly or indirectly, in the loss of the safety or effectiveness of the device or system containing it, and which must therefore meet very high standards of performance and reliability.
 - Note2) A hazard related device or system is one designed or intended for life support or maintenance of safety or for applications in medicine, aerospace, nuclear energy, or other fields, in which its failure to function or perform may reasonably be expected to result in loss of life or in significant injury or damage to person or property.
- It is the responsibility of the buyer or distributor of AKM products, who distributes, disposes of, or otherwise places the product with a third party, to notify such third party in advance of the above content and conditions, and the buyer or distributor agrees to assume any and all responsibility and liability for and hold AKM harmless from any and all claims arising from the use of said product in the absence of such notification.