



Chipsmall Limited consists of a professional team with an average of over 10 year of expertise in the distribution of electronic components. Based in Hongkong, we have already established firm and mutual-benefit business relationships with customers from,Europe,America and south Asia,supplying obsolete and hard-to-find components to meet their specific needs.

With the principle of “Quality Parts,Customers Priority,Honest Operation,and Considerate Service”,our business mainly focus on the distribution of electronic components. Line cards we deal with include Microchip,ALPS,ROHM,Xilinx,Pulse,ON,Everlight and Freescale. Main products comprise IC,Modules,Potentiometer,IC Socket,Relay,Connector.Our parts cover such applications as commercial,industrial, and automotives areas.

We are looking forward to setting up business relationship with you and hope to provide you with the best service and solution. Let us make a better world for our industry!



Contact us

Tel: +86-755-8981 8866 Fax: +86-755-8427 6832

Email & Skype: info@chipsmall.com Web: www.chipsmall.com

Address: A1208, Overseas Decoration Building, #122 Zhenhua RD., Futian, Shenzhen, China



Quad Port 10/100BASE-T LAN Transformer for Auto MDI/MDIX Extended Temperature



27.55 x 16.20 x 7.35mm

ALAN-409

RoHS/RoHS II Compliant

FEATURES:

- Meet IEEE802.3 specification
- Extended Temperature (-40°C - +85°C)
- ROHS peak reflow temperature rating 240°C
- 1500Vrms Hi-Pot

APPLICATIONS:

- Designed for most leading PHY IC manufacturers such as Broadcom, Marvell, Micrel, & Microsemi
- 10/100Base-T Ethernet-LAN
- VoIP
- Symmetrical Tx & RX channles for Auto MDI/MDIX capability
- Provides signal conditioning, EMI suppression and signal isolation.
- Hubs/Switches/Routers/Servers/NIC Cards

STANDARD SPECIFICATIONS:

Parameters	Minimum	Typical	Maximum	Units	Notes
Operating Temperature	-40		+85	°C	
Storage Temperature	-40		+85	°C	
Turn Ratio (± 2%)		1CT:1CT			
Inductance (OCL)	350			μH	100KHz/0.1V@8mA
Leakage Inductance (LL)			0.5	μH	100KHz/0.1V
Cw/w		30		pF	100KHz/0.1V
DC Resistance			1.2	Ω	
Insertion Loss			-1.0	dB	0.1-100MHz
Return Loss	-18			dB	2-30MHz
	-14.4				40MHz
	-13.1				50MHz
	-12				60-80MHz
Cross Talk	-55			dB	1MHz
	-40				30MHz
	-35				60MHz
	-30				100MHz
Differential to Common Mode Rejection	-30			dB	1-100MHz
Common Mode Rejection	-35			dB	1-60MHz
	-25				60-200MHz
Hi-Pot	1500Vrms				

OUTLINE DIMENSIONS:

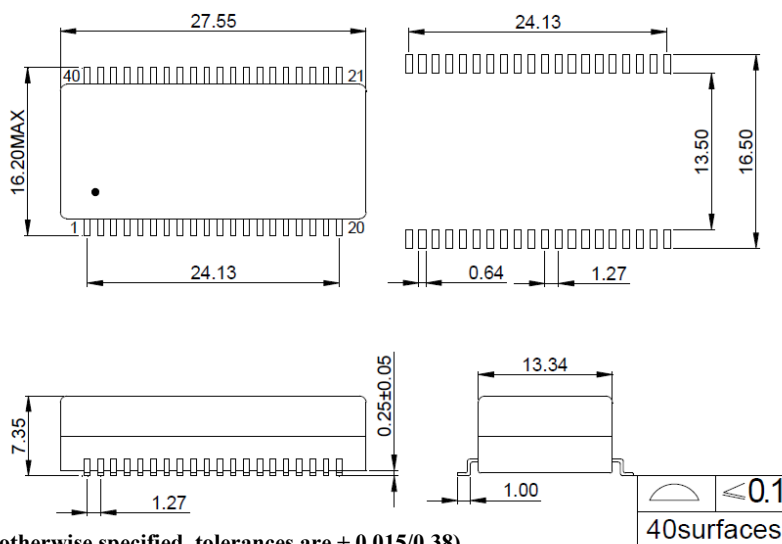

Dimensions: inch/mm (Unless otherwise specified, tolerances are ± 0.015/0.38)

ABRACON IS
ISO9001:2008
CERTIFIED

ABRACON[®]
The Power of Linking Together

2 Faraday, Suite# B | Irvine | CA 92618 **Revised: 03.25.15**
Ph. 949.546.8000 | Fax. 949.546.8001
Visit www.abracon.com for Terms and Conditions of Sale

Quad Port 10/100BASE-T LAN Transformer for Auto MDI/MDIX Extended Temperature



27.55 x 16.20 x 7.35mm

ALAN-409

RoHS/RoHS II Compliant

SCHEMATICS

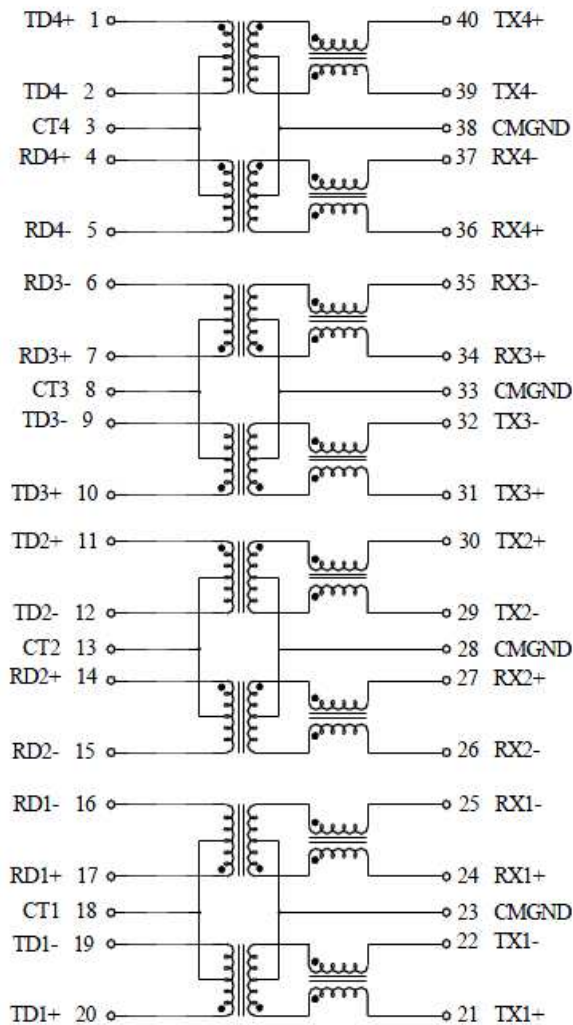

REFLOW PROFILE:

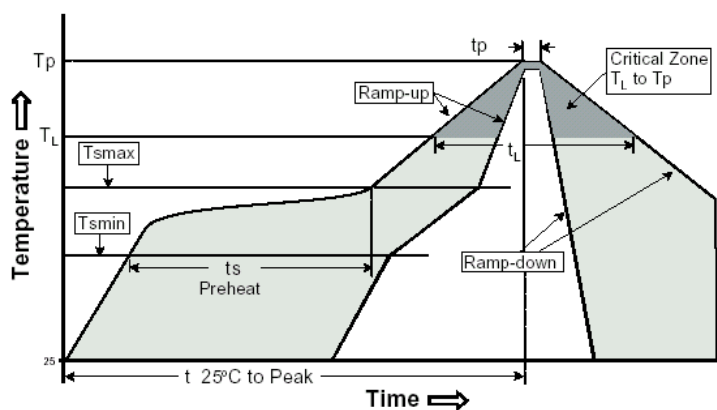

Profile Feature	Pb-Free Assembly
Average Ramp-Up Rate ($T_{s\max}$ to T_p)	3°C /second max.
Preheat -Temperature Min ($T_{s\min}$) -Temperature Max ($T_{s\max}$) -Time ($t_{s\min}$ to $t_{s\max}$)	150°C 200°C 60-120 seconds
Time maintained above: -Temperature (T_L) -Time (t_L)	217°C 60-150 seconds
Peak/Classification Temperature (T_p)	240±5°C
Time within 5°C of actual Peak Temperature (t_p)	20-40 seconds
Ramp-Down Rate	6°C /seconds max
Time 25°C to Peak Temperature	8 minutes max.

ABRACON IS
ISO9001:2008
CERTIFIED

ABRACON[®]
The Power of Linking Together LLC

2 Faraday, Suite# B | Irvine | CA 92618 **Revised: 03.25.15**
Ph. 949.546.8000 | Fax. 949.546.8001
Visit www.abracon.com for Terms and Conditions of Sale

Quad Port 10/100BASE-T LAN Transformer for Auto MDI/MDIX Extended Temperature



27.55 x 16.20 x 7.35mm

ALAN-409

RoHS/RoHS II Compliant

TAPE & REEL:

Packing 400 pcs / reel
Weight 2.7 grams / pcs

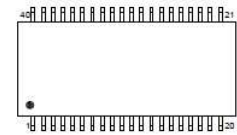

Mechanicals

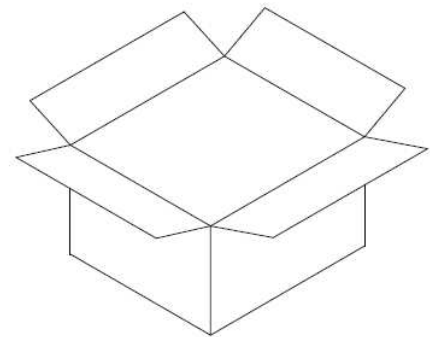
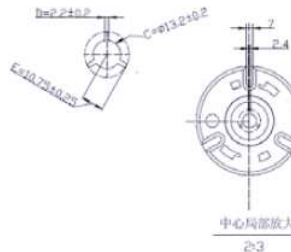
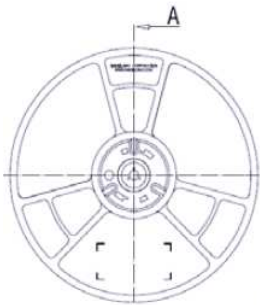
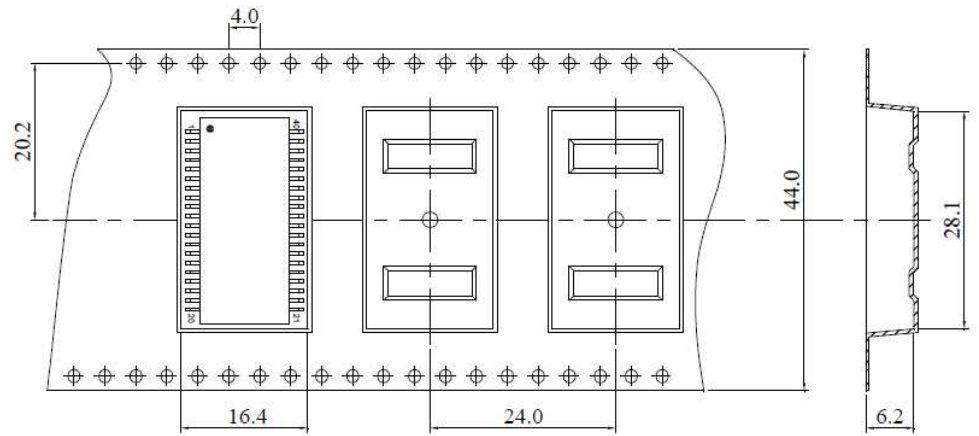

Dimensions: mm

ATTENTION: Abracon Corporation's products are COTS – Commercial-Off-The-Shelf products; suitable for Commercial, Industrial and, where designated, Automotive Applications. Abracon's products are not specifically designed for Military, Aviation, Aerospace, Life-dependant Medical applications or any application requiring high reliability where component failure could result in loss of life and/or property. For applications requiring high reliability and/or presenting an extreme operating environment, written consent and authorization from Abracon Corporation is required. Please contact Abracon Corporation for more information.

ABRACON IS
ISO9001:2008
CERTIFIED



2 Faraday, Suite# B | Irvine | CA 92618 **Revised: 03.25.15**
Ph. 949.546.8000 | Fax. 949.546.8001
Visit www.abracon.com for Terms and Conditions of Sale