



Chipsmall Limited consists of a professional team with an average of over 10 year of expertise in the distribution of electronic components. Based in Hongkong, we have already established firm and mutual-benefit business relationships with customers from,Europe,America and south Asia,supplying obsolete and hard-to-find components to meet their specific needs.

With the principle of “Quality Parts,Customers Priority,Honest Operation,and Considerate Service”,our business mainly focus on the distribution of electronic components. Line cards we deal with include Microchip,ALPS,ROHM,Xilinx,Pulse,ON,Everlight and Freescale. Main products comprise IC,Modules,Potentiometer,IC Socket,Relay,Connector.Our parts cover such applications as commercial,industrial, and automotives areas.

We are looking forward to setting up business relationship with you and hope to provide you with the best service and solution. Let us make a better world for our industry!



## Contact us

Tel: +86-755-8981 8866 Fax: +86-755-8427 6832

Email & Skype: info@chipsmall.com Web: www.chipsmall.com

Address: A1208, Overseas Decoration Building, #122 Zhenhua RD., Futian, Shenzhen, China



## New from Amphenol

### Introducing the NEW QuickSNAP™ Lightning Bushing

INTRODUCING  
The NEW QuickSNAP™ Lightning Bushing

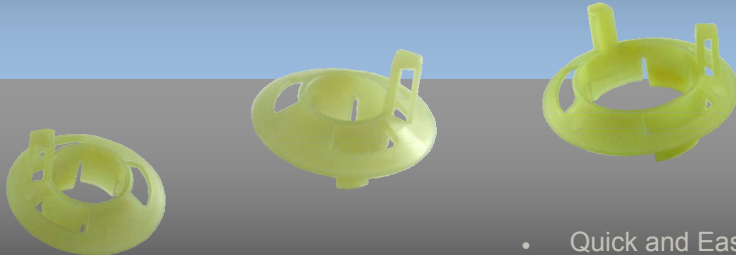

- Quick and Easy Installation.
- Reduces FOD.
- Lightweight.

### Other System Attachments



### High Performance Clamps



### Anchor Supports

Amphenol has over 30 years experience in System Attachment technology, serving the Aerospace, Military, Industrial and extreme environment markets. The company produces high quality products and prides itself on timely and accurate delivery.

Designed to help guide wired bundles through airframe stringers and frames, Amphenol's QuickSNAP™ Lightning Bushings were designed with lean manufacturing in mind. Unlike traditional lightning bushings, our products, whether it's our one-piece design or two-piece design, significantly reduce installation times and reduce the amount of FOD on the aircraft. The lightweight QuickSNAP's are made with smooth edges in order to reduce wire chaffing, and although they are available in various standard configurations and sizes, we offer custom-made product as well.

### Traditional Lightning Bushing

**15 MINUTES to INSTALL!**

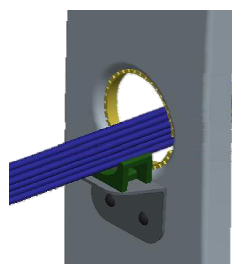

**Six Part Installation**

3 rivets	1 nylon part
1 caterpillar	1 sheet metal part

### Amphenol's QuickSNAP Lightning Bushing

**15 SECONDS to INSTALL!**

**A better way!**

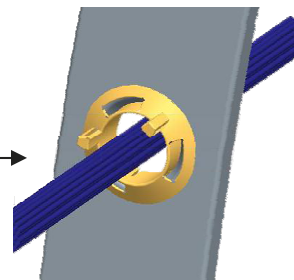

**One Part Installation**

1 Amphenol QuickSNAP Lightning Bushing

### Features & Benefits

- Snap-In design makes it quick and easy to install—no tools are required
- No glue or other hardware is necessary—reduces FOD!
- Made of lightweight material
- Smooth edges reduces wire chaffing
- Offered in two different designs: one piece or two pieces
- Custom variations are available upon request



## Additional Information

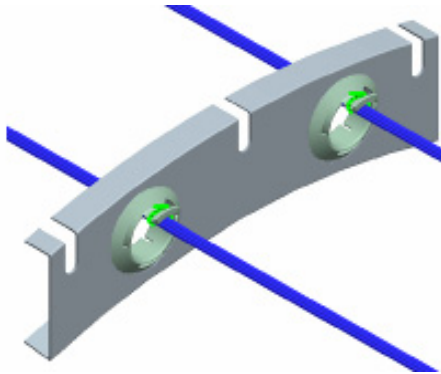

Depending upon what your requirements are, Amphenol can accommodate your needs.

Simply provide the hole diameter and frame thickness, and we'll take care of the rest.

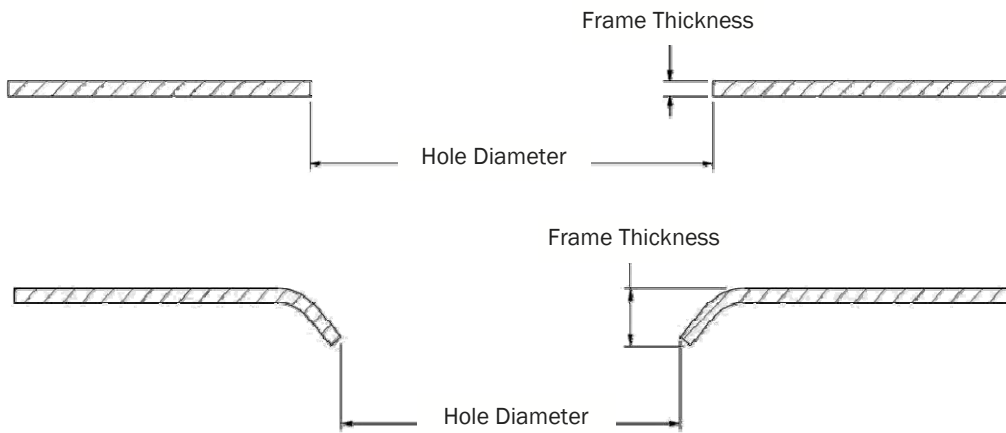

### CUSTOMIZATION LIGHTENING BUSHING

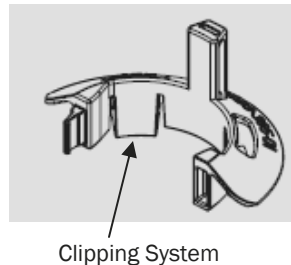
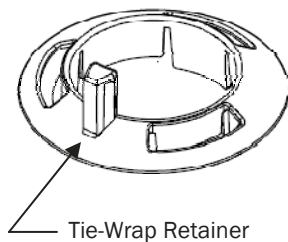

### TECHNICAL SPECIFICATIONS

Material	Polyamide 6/6 (Nylon)
Temperature Range	-55°C to 150°C
Flamability	FAR 25.853
Density	0.041185 lbs/in <sup>3</sup>

#### Product Customization

Amphenol AirLB NA welcomes inquiries for application-specific modifications to our QuickSNAP Lightning Bushings. Our products are continuously expanding to meet current and future customer needs.

### Related Amphenol Products



**JB™ Jig Board Clamps**



**Frame & Stringer Clip-On Supports**



**Raceways**

### Contact Information

#### Amphenol AirLB NA

3335 1ere Rue  
St-Hubert, Qc. J3Y 8Y6 Canada  
email: [info@amphenol-airlb.com](mailto:info@amphenol-airlb.com)  
Tel: 450-445-6007