



Chipsmall Limited consists of a professional team with an average of over 10 year of expertise in the distribution of electronic components. Based in Hongkong, we have already established firm and mutual-benefit business relationships with customers from,Europe,America and south Asia,supplying obsolete and hard-to-find components to meet their specific needs.

With the principle of “Quality Parts,Customers Priority,Honest Operation,and Considerate Service”,our business mainly focus on the distribution of electronic components. Line cards we deal with include Microchip,ALPS,ROHM,Xilinx,Pulse,ON,Everlight and Freescale. Main products comprise IC,Modules,Potentiometer,IC Socket,Relay,Connector.Our parts cover such applications as commercial,industrial, and automotives areas.

We are looking forward to setting up business relationship with you and hope to provide you with the best service and solution. Let us make a better world for our industry!



Contact us

Tel: +86-755-8981 8866 Fax: +86-755-8427 6832

Email & Skype: info@chipsmall.com Web: www.chipsmall.com

Address: A1208, Overseas Decoration Building, #122 Zhenhua RD., Futian, Shenzhen, China



QUAD/DUAL ELECTRICALLY PROGRAMMABLE ANALOG DEVICE (EPAD™)

GENERAL DESCRIPTION

ALD1108E/ALD1110E are monolithic quad/dual EPAD® (Electrically Programmable Analog Device) N-channel MOSFETs with electrically adjustable threshold (turn-on) voltage. The ALD1108E/ALD1110E are matched and adjusted (e-trimmed) at the factory resulting in quad/dual MOSFETs that are highly matched in threshold voltages and other electrical characteristics. For a given input voltage, the threshold voltage of a MOSFET device determines its drain on-current, resulting in an on-resistance characteristic that can be precisely preset and then controlled by the input voltage very accurately.

Using an ALD1108E/ALD1110E is simple and straight forward. The MOSFETs function as n-channel MOSFETs, except that all the devices have exceptional matching to each other in electrical characteristics. Since these devices are on the same monolithic chip, they also exhibit excellent tempco matching characteristics.

These MOSFET devices have very low input currents, and as a result a very high input impedance (>10¹² Ohm). The gate voltage from a control source can drive many MOSFET inputs with practically no loading effects. Used in precision current mirror or current multiplier applications, they can be used to provide a current source over a 100nA to 3mA range, and with either a positive, negative or zero tempco.

ORDERING INFORMATION (“L” suffix denotes lead-free (RoHS))

Operating Temperature Range*		
0°C to +70°C	0°C to +70°C	-55°C to +125°C
8-Pin SOIC Package	8-Pin Plastic Dip Package	8-Pin Cerdip Package
ALD1110ESAL	ALD1110EPAL	ALD1110EDA
16-Pin SOIC Package	16-Pin Plastic Dip Package	16-Pin Cerdip Package
ALD1108ESCL	ALD1108EPCL	ALD1108EDC

* Contact factory for leaded (non-RoHS) or high temperature versions.

BLOCK DIAGRAM

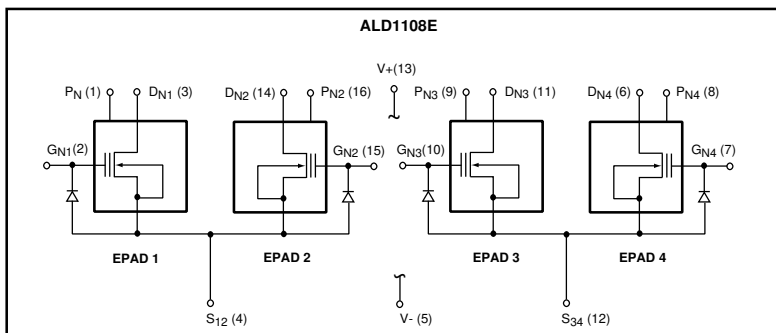

BENEFITS

- Precision matched electrically after packaging
- Simple, elegant single-chip user option to trim voltage/current values
- Excellent device matching characteristics with or without additional electrical trim
- Remotely and electrically trim parameters on circuits that are physically inaccessible

PIN CONFIGURATION

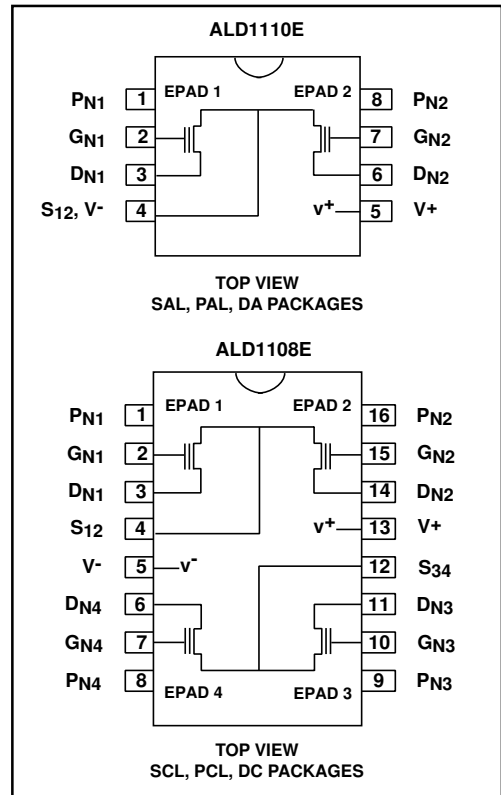

BLOCK DIAGRAM

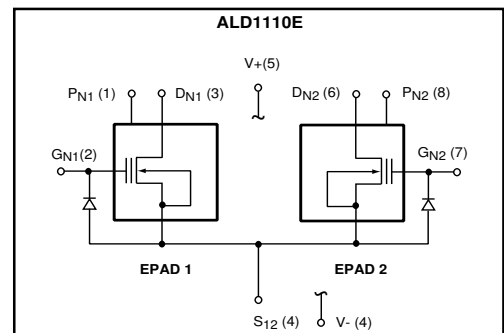

Optional EPAD Threshold Voltage Trimming by User

The basic EPAD MOSFET device is a monotonically adjustable device, which means the device can normally be e-trimmed to increase in threshold voltage and to decrease in drain-on current as a function of a given input bias voltage. Used as an in-circuit element for trimming or setting a combination of voltage, current and/or on-resistance characteristics, it can be set up to be e-trimmed remotely and automatically. Once e-trimmed, the set voltage and current levels are stored indefinitely inside the device as a nonvolatile stored charge, which is not affected during normal operation of the device, even when power is turned off. A given EPAD device can be adjusted many times to continually increase its threshold voltage. A pair of EPAD devices can also be connected differentially such that one device is used to adjust a parameter in one direction and the other device is used to adjust the same parameter in the other direction.

The ALD1108E/ALD1110E can be e-trimmed with an ALD EPAD programmer to obtain the desired voltage and current levels. They can also be e-trimmed as an active in-system element in a user system, via user designed interface circuitry. P_{N1} , P_{N2} , etc., are pins required for optional e-trim of respective MOSFET devices. If unused, these pins are to be connected to V- or ground. For more information, see Application Note AN1108.

APPLICATIONS

- Precision PC-based electronic calibration
- Automated voltage trimming or setting
- Remote voltage or current adjustment of inaccessible nodes
- PCMCIA based instrumentation trimming
- Electrically adjusted resistive load
- Temperature compensated current sources and current mirrors
- Electrically trimmed/calibrated current sources
- Permanent precision preset voltage level shifter
- Low temperature coefficient voltage and/or current bias circuits
- Multiple preset voltage bias circuits
- Multiple channel resistor pull-up or pull-down circuits
- Microprocessor based process control systems
- Portable data acquisition systems
- Battery operated terminals and instruments
- Remote telemetry systems
- E-trimmable gain amplifiers
- Low level signal conditioning
- Sensor and transducer bias currents
- Neural networks

BENEFITS (cont.)

- Usable in environmentally sealed circuits
- No mechanical moving parts -- high G-shock tolerance
- Improved reliability, dependability, dust and moisture resistance
- Cost and labor savings
- Small footprint for high board density applications

FEATURES

- Electrically Programmable Analog Device
- Proven, non-volatile CMOS technology
- Operates from 2V, 3V, 5V to 10V
- Flexible basic circuit building block and design element
- Very high resolution -- average e-trim voltage resolution of 0.1mV
- Wide dynamic range -- current levels from 0.1 μ A to 3000 μ A
- Voltage adjustment range from 1.000V to 3.000V in 0.1mV steps
- Typical 10-year drift of less than 2mV
- Usable in voltage mode or current mode
- High input impedance -- $10^{12}\Omega$
- Very high DC current gain -- greater than 10^9
- Device operating current has positive temperature coefficient range and negative temperature coefficient range with cross-over zero temperature coefficient current level at 68 μ A
- Tight matching and tracking of on-resistance between different devices with e-trim
- Very low input currents and leakage currents
- Low cost, monolithic technology
- Application-specific or in-system programming modes
- Optional user software-controlled automation
- Optional e-trim of any standard/custom configuration
- Micropower operation
- Available in standard PDIP, SOIC and hermetic CDIP packages
- Suitable for matched-pair balanced circuit configuration
- Suitable for both coarse and fine trimming, as well as matched MOSFET array applications
- RoHS compliant

ABSOLUTE MAXIMUM RATINGS

Supply voltage, V ⁺ referenced to V ⁻	-0.3V to +10.6V
Supply voltage, V _S referenced to V ⁻	±5.3V
Differential input voltage range	-0.3V to +0.3V
Power dissipation	600mW
Operating temperature range	SAL, PAL, SCL, PCL packages 0°C to +70°C
	DA, DC packages -55°C to +125°C
Storage temperature range	-65°C to +150°C
Lead temperature, 10 seconds	+260°C

CAUTION: ESD Sensitive Device. Use static control procedures in ESD controlled environment.

OPERATING ELECTRICAL CHARACTERISTICS

T_A = 25°C V⁺ = +5.0V unless otherwise specified

Parameter	Symbol	ALD1108E			ALD1110E			Unit	Test Conditions
		Min	Typ	Max	Min	Typ	Max		
Supply Voltage ¹	V ⁺			10.0			10.0	V	
Initial Threshold Voltage ²	V _{ti}	0.990	1.000	1.010	0.990	1.000	1.010	V	I _{DS} = 1μA T _A = 21°C
E-trim V _t Range	V _t	1.000		3.000	1.000		3.000	V	
Drain - Gate Connected Voltage Tempco	TCV _{DS}		-1.6 -0.3 0.0 +2.7			-1.6 -0.3 0.0 +2.7		mV/°C mV/°C mV/°C mV/°C	I _D = 5μA I _D = 50μA I _D = 68μA I _D = 500μA
Initial Offset Voltage ³	V _{OSi}		1	5		1	5	mV	
Tempco of V _{OS}	TCV _{OS}		5			5		μV/°C	V _{DS1} = V _{DS2}
Differential Threshold Voltage ⁴	DV _t			2.000			2.000	V	
Tempco of Differential Threshold Voltage ⁴	TCDV _t		0.033			0.033		mV/°C	
Long Term Drift	ΔV _t /Δt		-0.02	-0.05		-0.02	-0.05	mV	1000 Hours
Long Term Drift Match	ΔV _t /Δt		-5			-5		μV	1000 Hours
Drain Source On Current	I _{DS(ON)}		3.0			3.0		mA	V _G = V _D = 5V V _S = 0V V _t = 1.0
Drain Source On Current ⁴	I _{DS(ON)}		0.8			0.8		mA	V _G = V _D = 5V V _S = 0V V _t = 3.0
Initial Zero Tempco Voltage ³	V _{ZTCi}		1.52			1.52		V	V _t = 1.000V
Zero Tempco Current	I _{ZTC}		68			68		μA	
Initial On-Resistance ³	R _{ONi}		500			500		Ω	V _{GSj} = 5V V _{DS} = 0.1V
On-Resistance Match	ΔR _{ON}		0.5			0.5		%	

NOTES:

- Supply voltage is limited by Threshold Voltage. V⁺ must be the most positive supply rail and V⁻ must be at the most negative supply rail. Source terminals other than those labeled as V⁻ can be at any voltage between V⁻ and V⁺.
- Initial Threshold Voltage is set at the factory. If no EPAD V_t trimming is intended by user, then this is also the final or permanent threshold voltage value.
- Initial and Final values are the same unless deliberately changed by user.
- These parameters apply only when V_t of one or more of the devices are to be changed by user.

OPERATING ELECTRICAL CHARACTERISTICS (cont'd)

T_A = 25°C V₊ = +5.0V unless otherwise specified

Parameter	Symbol	ALD1108E			ALD1110E			Unit	Test Conditions
		Min	Typ	Max	Min	Typ	Max		
Transconductance	gm		1.4			1.4		mA/V	V _D = 10V, V _G = V _t + 4.0
Transconductance Match	Δgm		25			25		μA/V	V _D = 10V, V _G = V _t + 4.0
Low Level Output Conductance	g _{OL}		6			6		μA/V	V _G = V _t + 0.5V
High Level Output Conductance	g _{OH}		68			68		μA/V	V _G = V _t + 4.0V
Drain Off Leakage Current	I _{D(OFF)}		5	400 4		5	400 4	pA nA	T _A = 125°C
Gate Leakage Current	I _{GSS}		10	100 1		10	100 1	pA nA	T _A = 125°C
Input Capacitance	C _{ISS}		25			25		pF	
Cross Talk			60			60		dB	f = 100KHz
Relaxation Time Constant ⁴	t _{RLX}		2			2		Hours	
Relaxation Voltage ⁴	V _{RLX}		-0.3			-0.3		%	1.0V ≤ V _t ≤ 3.0V

E-TRIM CHARACTERISTICS

T_A = 25°C V₊ = +5.0V unless otherwise specified

Parameter	Symbol	ALD1108E			ALD1110E			Unit	Test Conditions
		Min	Typ	Max	Min	Typ	Max		
E-trim V _t Range ⁴	V _t	1.000		3.000	1.000		3.000	V	
Resolution of V _t E-trim Pulse Step ⁴	RV _t		0.1	1		0.1	1	mV	
Change in V _t Per E-trim Pulse ⁴	ΔV _t / N		0.5 0.05			0.5 0.05		mV/ pulse	V _t = 1.0V V _t = 2.5V
E-trim Pulse Voltage ⁴	V _p	11.75	12.00	12.25	11.75	12.00	12.25	V	
E-trim Pulse Current ⁴	I _p		2			2		mA	
Pulse Frequency ⁴	f pulse		50			50		KHz	

TYPICAL PERFORMANCE CHARACTERISTICS

OUTPUT CHARACTERISTICS

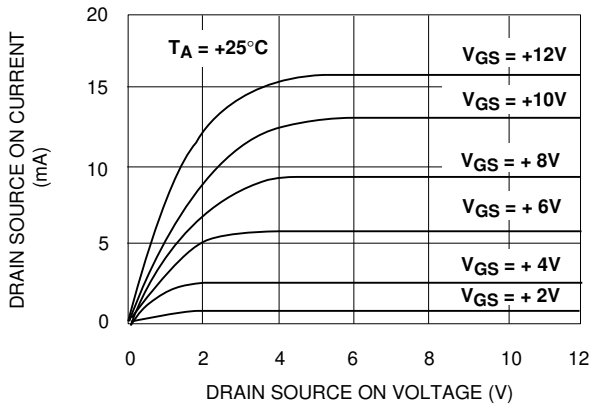

OUTPUT CHARACTERISTICS

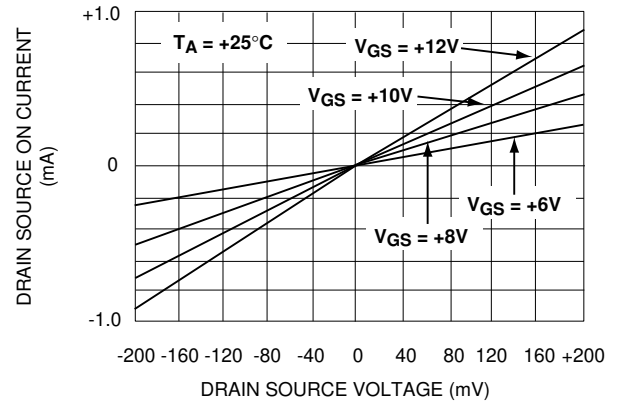

DRAIN SOURCE ON CURRENT vs. AMBIENT TEMPERATURE

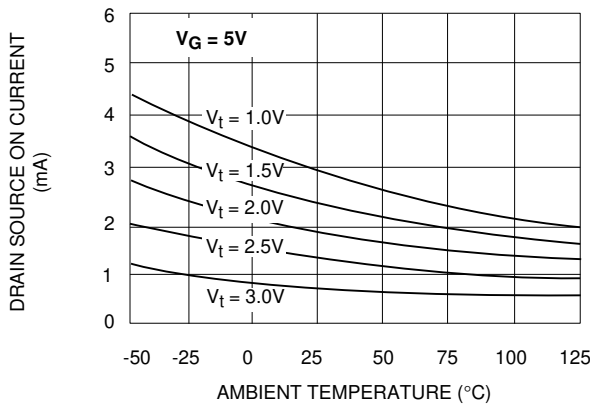

DRAIN SOURCE ON CURRENT vs. THRESHOLD VOLTAGE

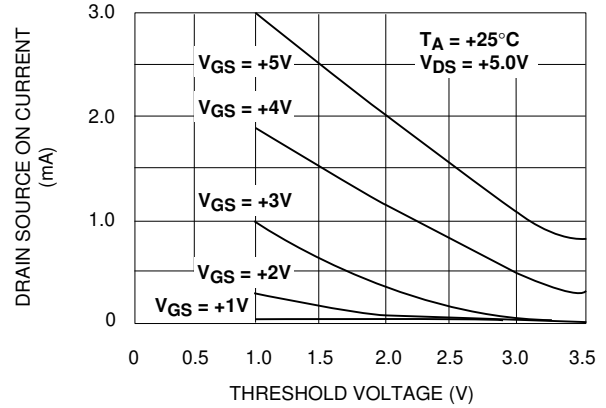

TRANSCONDUCTANCE vs. THRESHOLD VOLTAGE

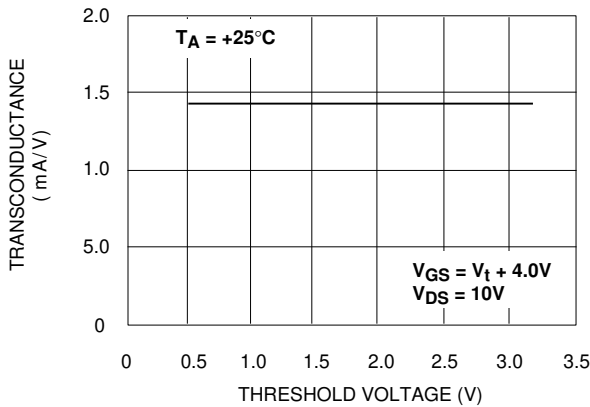

HIGH LEVEL OUTPUT CONDUCTANCE vs. THRESHOLD VOLTAGE

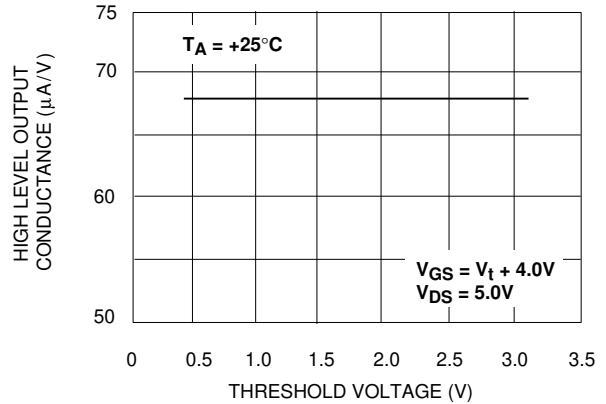

TYPICAL PERFORMANCE CHARACTERISTICS (cont.)

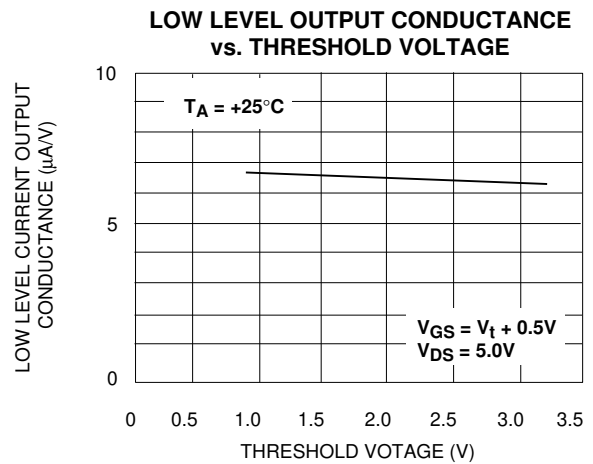
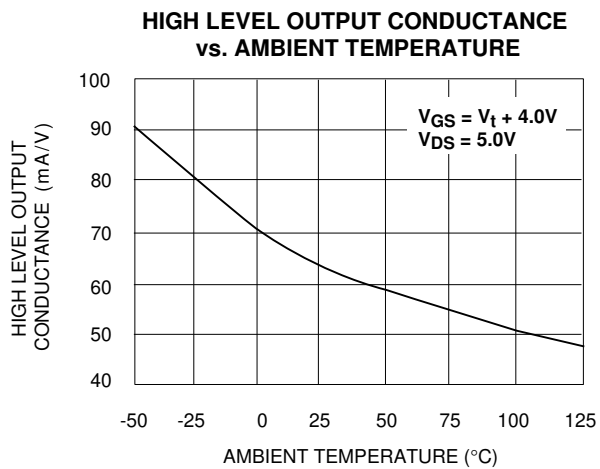
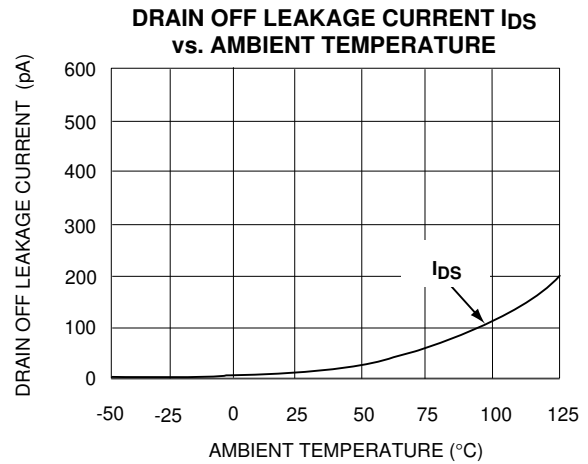
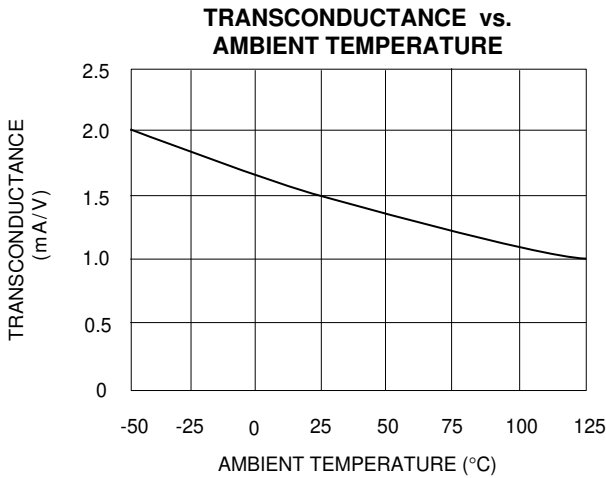
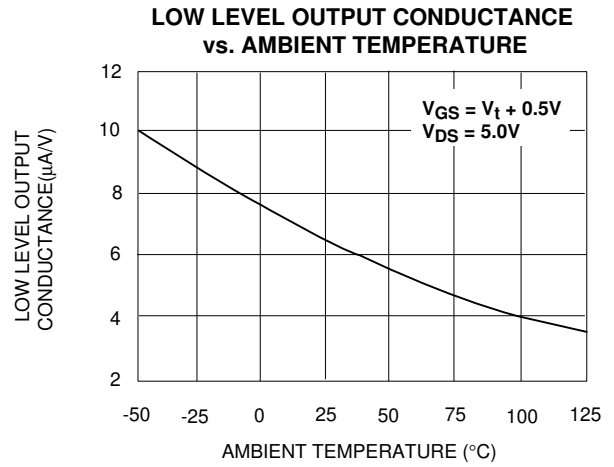
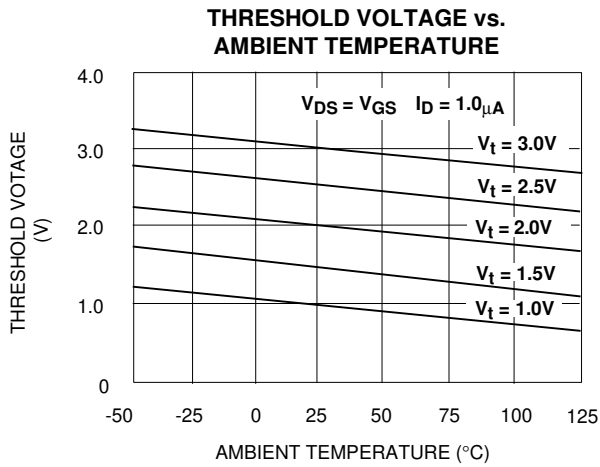

TYPICAL PERFORMANCE CHARACTERISTICS (cont.)

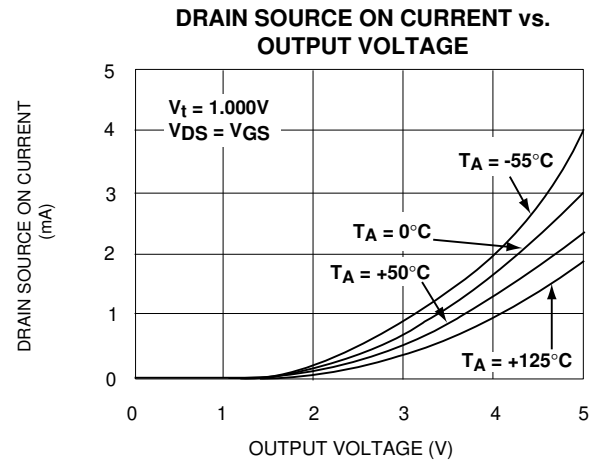
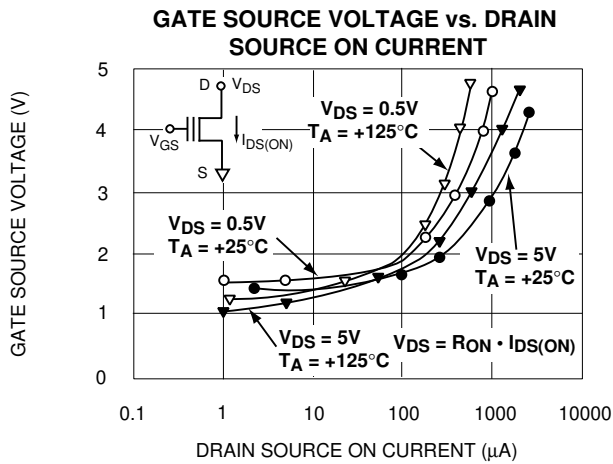
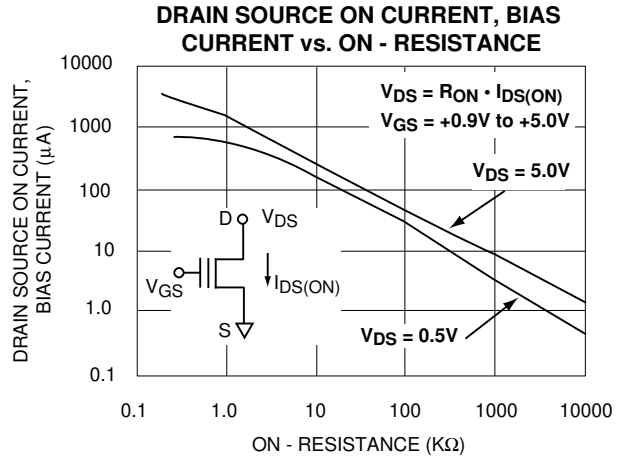
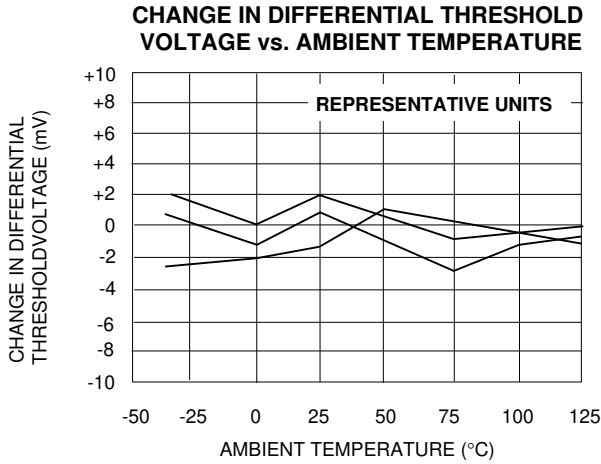
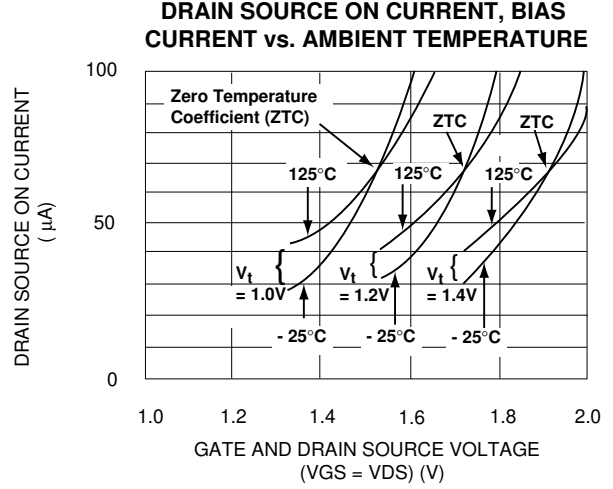
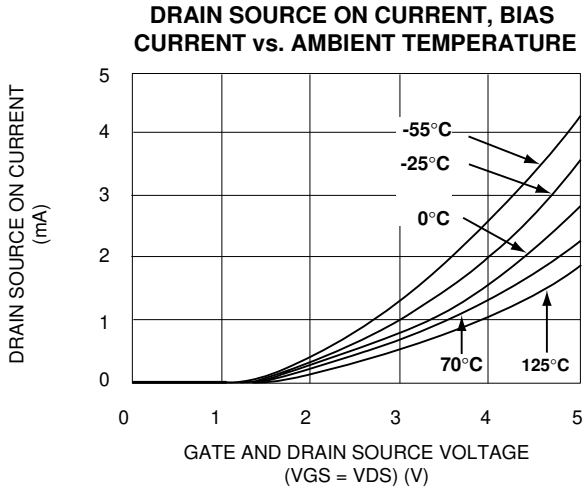

TYPICAL PERFORMANCE CHARACTERISTICS (cont.)

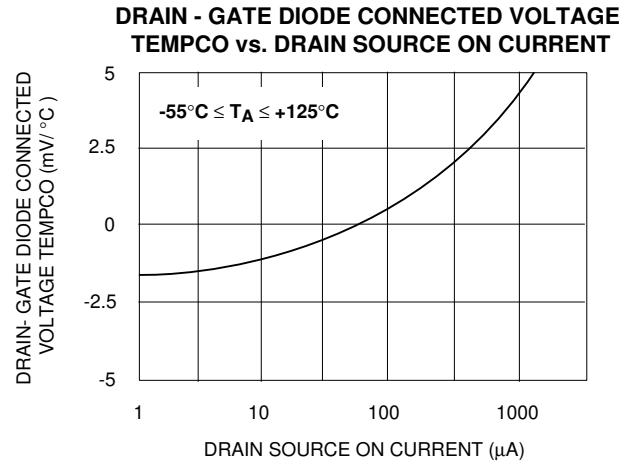
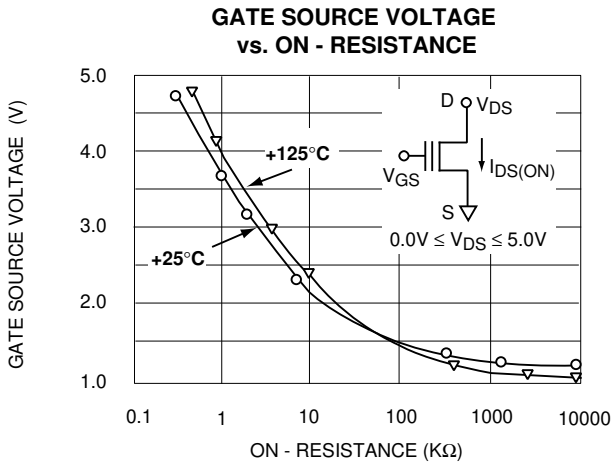
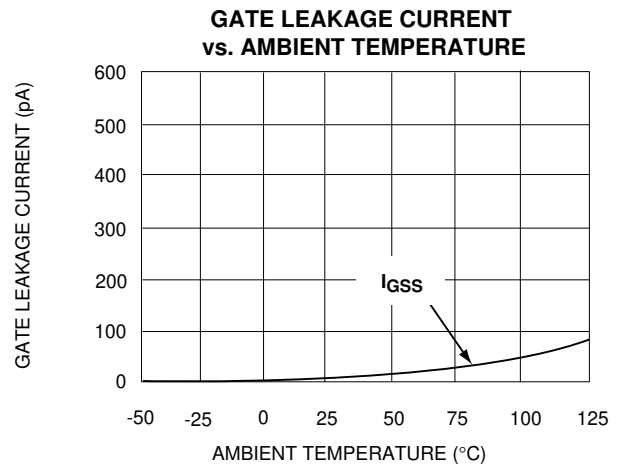
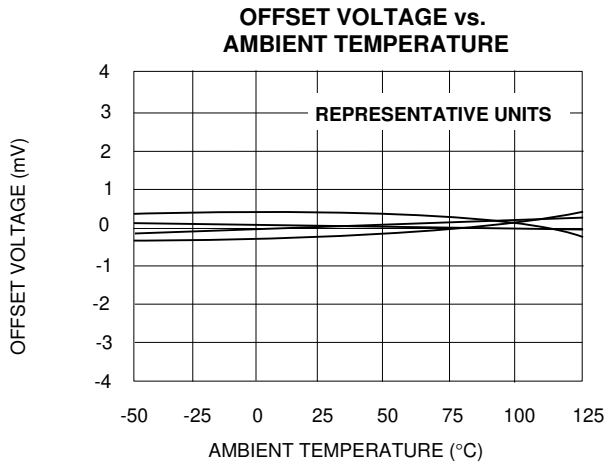

SOIC-8 PACKAGE DRAWING

8 Pin Plastic SOIC Package

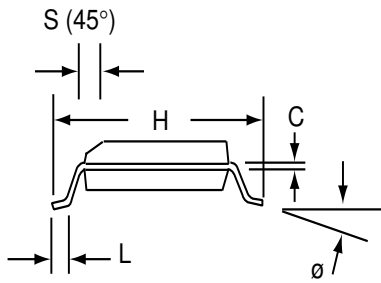
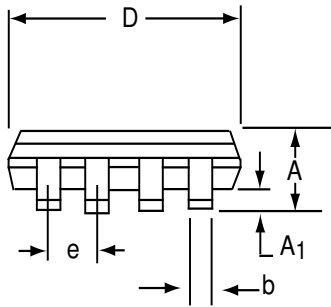
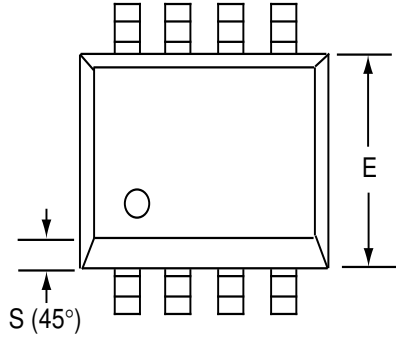

Dim	Millimeters		Inches	
	Min	Max	Min	Max
A	1.35	1.75	0.053	0.069
A ₁	0.10	0.25	0.004	0.010
b	0.35	0.45	0.014	0.018
C	0.18	0.25	0.007	0.010
D-8	4.69	5.00	0.185	0.196
E	3.50	4.05	0.140	0.160
e	1.27 BSC		0.050 BSC	
H	5.70	6.30	0.224	0.248
L	0.60	0.937	0.024	0.037
Ø	0°	8°	0°	8°
S	0.25	0.50	0.010	0.020

PDIP-8 PACKAGE DRAWING

8 Pin Plastic DIP Package

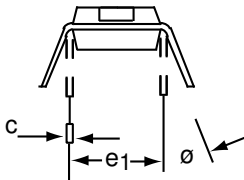
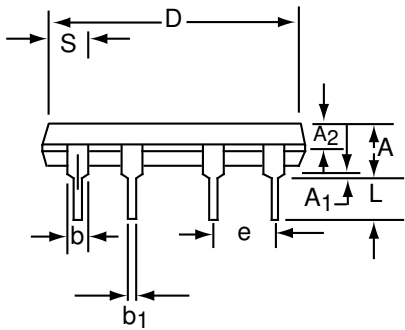
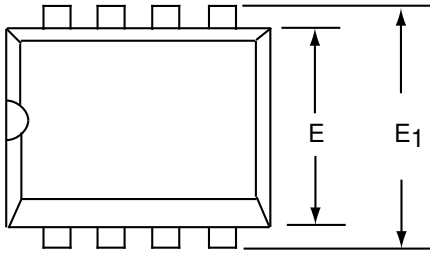

Dim	Millimeters		Inches	
	Min	Max	Min	Max
A	3.81	5.08	0.105	0.200
A ₁	0.38	1.27	0.015	0.050
A ₂	1.27	2.03	0.050	0.080
b	0.89	1.65	0.035	0.065
b ₁	0.38	0.51	0.015	0.020
c	0.20	0.30	0.008	0.012
D-8	9.40	11.68	0.370	0.460
E	5.59	7.11	0.220	0.280
E ₁	7.62	8.26	0.300	0.325
e	2.29	2.79	0.090	0.110
e ₁	7.37	7.87	0.290	0.310
L	2.79	3.81	0.110	0.150
S-8	1.02	2.03	0.040	0.080
θ	0°	15°	0°	15°

CERDIP-8 PACKAGE DRAWING

8 Pin CERDIP Package

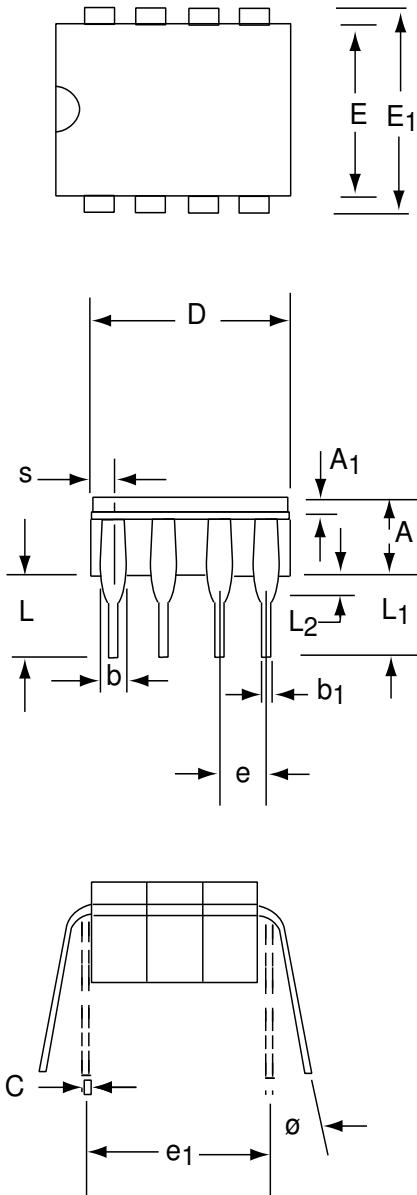

Dim	Millimeters		Inches	
	Min	Max	Min	Max
A	3.55	5.08	0.140	0.200
A₁	1.27	2.16	0.050	0.085
b	0.97	1.65	0.038	0.065
b₁	0.36	0.58	0.014	0.023
C	0.20	0.38	0.008	0.015
D-8	--	10.29	--	0.405
E	5.59	7.87	0.220	0.310
E₁	7.73	8.26	0.290	0.325
e	2.54 BSC		0.100 BSC	
e₁	7.62 BSC		0.300 BSC	
L	3.81	5.08	0.150	0.200
L₁	3.18	--	0.125	--
L₂	0.38	1.78	0.015	0.070
S	--	2.49	--	0.098
∅	0°	15°	0°	15°

SOIC-16 PACKAGE DRAWING

16 Pin Plastic SOIC Package

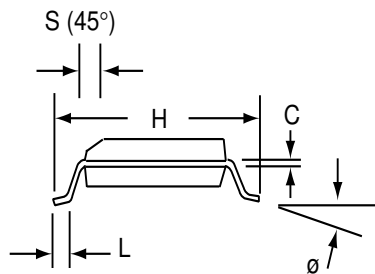
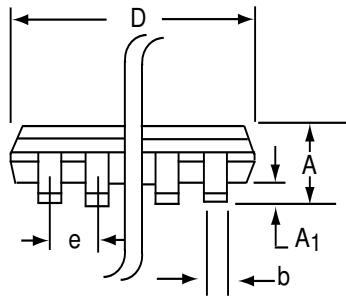
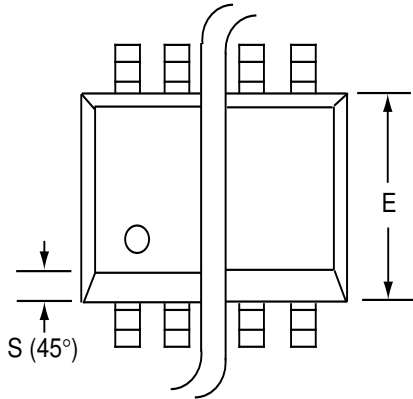

Dim	Millimeters		Inches	
	Min	Max	Min	Max
A	1.35	1.75	0.053	0.069
A ₁	0.10	0.25	0.004	0.010
b	0.35	0.45	0.014	0.018
C	0.18	0.25	0.007	0.010
D-16	9.80	10.00	0.385	0.394
E	3.50	4.05	0.140	0.160
e	1.27 BSC		0.050 BSC	
H	5.70	6.30	0.224	0.248
L	0.60	0.937	0.024	0.037
θ	0°	8°	0°	8°
S	0.25	0.50	0.010	0.020

PDIP-16 PACKAGE DRAWING

16 Pin Plastic DIP Package

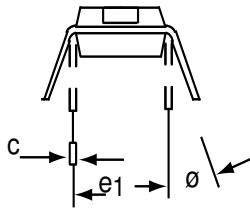
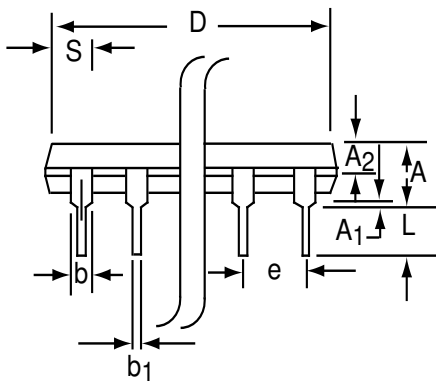
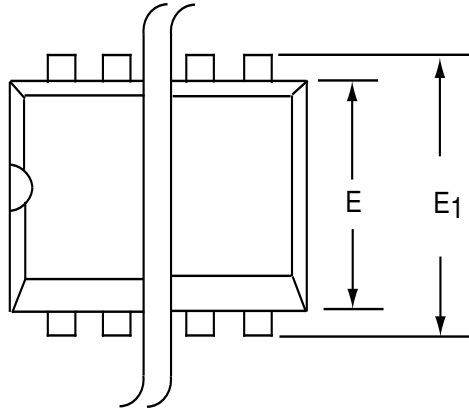

Dim	Millimeters		Inches	
	Min	Max	Min	Max
A	3.81	5.08	0.105	0.200
A₁	0.38	1.27	0.015	0.050
A₂	1.27	2.03	0.050	0.080
b	0.89	1.65	0.035	0.065
b₁	0.38	0.51	0.015	0.020
c	0.20	0.30	0.008	0.012
D-16	18.93	21.33	0.745	0.840
E	5.59	7.11	0.220	0.280
E₁	7.62	8.26	0.300	0.325
e	2.29	2.79	0.090	0.110
e₁	7.37	7.87	0.290	0.310
L	2.79	3.81	0.110	0.150
S-16	0.38	1.52	0.015	0.060
θ	0°	15°	0°	15°

CERDIP-16 PACKAGE DRAWING

16 Pin CERDIP Package

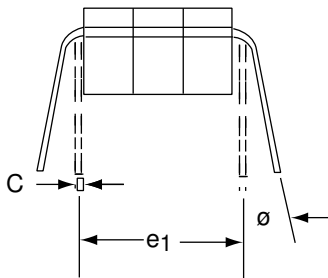
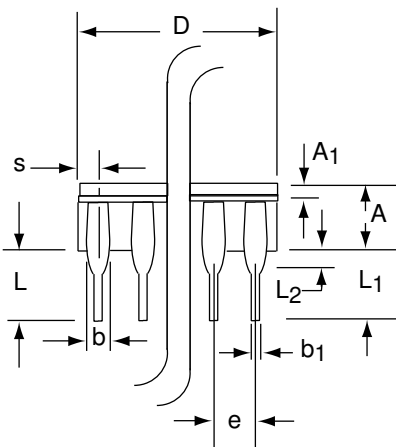
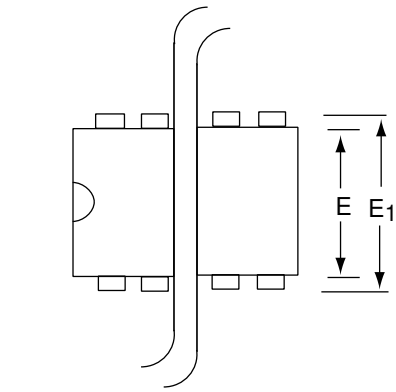

Dim	Millimeters		Inches	
	Min	Max	Min	Max
A	3.55	5.08	0.140	0.200
A₁	1.27	2.16	0.050	0.085
b	0.97	1.65	0.038	0.065
b₁	0.36	0.58	0.014	0.023
C	0.20	0.38	0.008	0.015
D-16	--	21.34	--	0.840
E	5.59	7.87	0.220	0.310
E₁	7.73	8.26	0.290	0.325
e	2.54 BSC		0.100 BSC	
e₁	7.62 BSC		0.300 BSC	
L	3.81	5.08	0.150	0.200
L₁	3.18	--	0.125	--
L₂	0.38	1.78	0.015	0.070
S	--	2.49	--	0.098
Ø	0°	15°	0°	15°