



Chipsmall Limited consists of a professional team with an average of over 10 year of expertise in the distribution of electronic components. Based in Hongkong, we have already established firm and mutual-benefit business relationships with customers from,Europe,America and south Asia,supplying obsolete and hard-to-find components to meet their specific needs.

With the principle of “Quality Parts,Customers Priority,Honest Operation,and Considerate Service”,our business mainly focus on the distribution of electronic components. Line cards we deal with include Microchip,ALPS,ROHM,Xilinx,Pulse,ON,Everlight and Freescale. Main products comprise IC,Modules,Potentiometer,IC Socket,Relay,Connector.Our parts cover such applications as commercial,industrial, and automotives areas.

We are looking forward to setting up business relationship with you and hope to provide you with the best service and solution. Let us make a better world for our industry!



Contact us

Tel: +86-755-8981 8866 Fax: +86-755-8427 6832

Email & Skype: info@chipsmall.com Web: www.chipsmall.com

Address: A1208, Overseas Decoration Building, #122 Zhenhua RD., Futian, Shenzhen, China



ALS50-24

Description:

The ALS50-24 is a single output power supply. It provides a DC output power in a cost-effective open frame package. Excellent performance specifications are provided, together with compliance to European EMC (EN55022, Class A), and Low Voltage directive (TUV EN60950).

Specifications (@25C)

Input Characteristics:

Input Voltage (5):	110/220Vac (90-260Vac, 120-370Vdc)
Input Frequency Range (1):	47-63Hz
Max Input Current:	1.0A @ 110Vac; 0.5A @ 220Vac
Max Inrush Current:	30A @ 220VAC
Hold-Up Time:	17ms typ @ 110Vac, 100% Load

Output Characteristics:

Output Voltage:	24.0Vdc
Output Current (1):	2.1A
Output Power (1):	50W
Ripple & Noise (20 MHz BW):	240mV
Line Regulation (4):	1.0%
Load Regulation (3):	2.0%
Temperature Drift:	0.02%/°C
Rise-up Time:	500ms max, 110Vac, 100% Load
Over Current Protection:	Shutdown, O.C.P Point>120%, recycle AC supply to recover
Over Voltage Protection:	>105% Zener across output
Short Circuit Protection:	Unit shutdown, recycle AC supply to recover
Adj. O/P Voltage Range (1,2):	±10%

Environmental Specifications:

EMI (Conducted RFI):	Built to comply with EN55022-B
EFT:	Built to comply with IEC61000-4-4
ESD:	Built to comply with IEC61000-4-2
Surge:	Built to comply with IEC61000-4-5
Operating Temperature:	Convection cooling 0 to 50°C:100%; 60°C:70%
Operating Humidity:	30% to 90% RH
Storage Temperature:	-25 to 85°C
Storage Humidity:	10% to 95% RH
Cooling:	Convection cooling
Vibration:	1min sweep 10-55Hz, 2G Amplitude, X,Y,Z axis 1hr each
Shock:	<20G

General Specifications:

Efficiency:	70% Typical
Dimensions (WxLxH):	76.20x127x35.56mm
Weight:	300g
Warranty:	2 years @ 40°C, 100% Load

Safety Standards:

Standard:	UL1950 (E204980) TUV EN60950 (50070245) Built to meet CSA 22.2
Dielectric Strength:	I/P-O/P:3kVac, I/P-FG:2.5kVac, <10mA, 1min
Insulation Resistance:	O/P-FG: 500VDC>100Mohms



DERATING CURVE

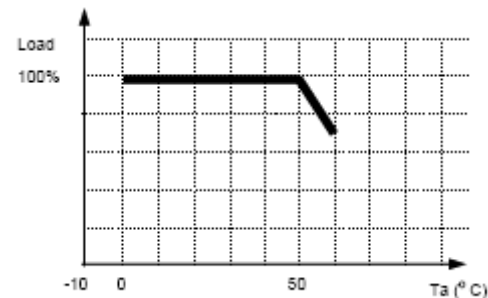

Technical Notes:

1. Throughout V_{in} range. V_{out} must be measured as near as possible to power supply.
2. Total output power by any combination of channel must not exceed $P_{ou(m)}$.
3. V_{out} deviation as I_{out} varies from $I_{o(min)}$ - $I_{o(max)}$.
4. V_{out} deviation as V_{in} varies from 90 – 260Vac.
5. Where UL and CSA is concerned, official rated input voltage range is 100-120Vac/200-240Vac.

Outline Dimensions (mm):

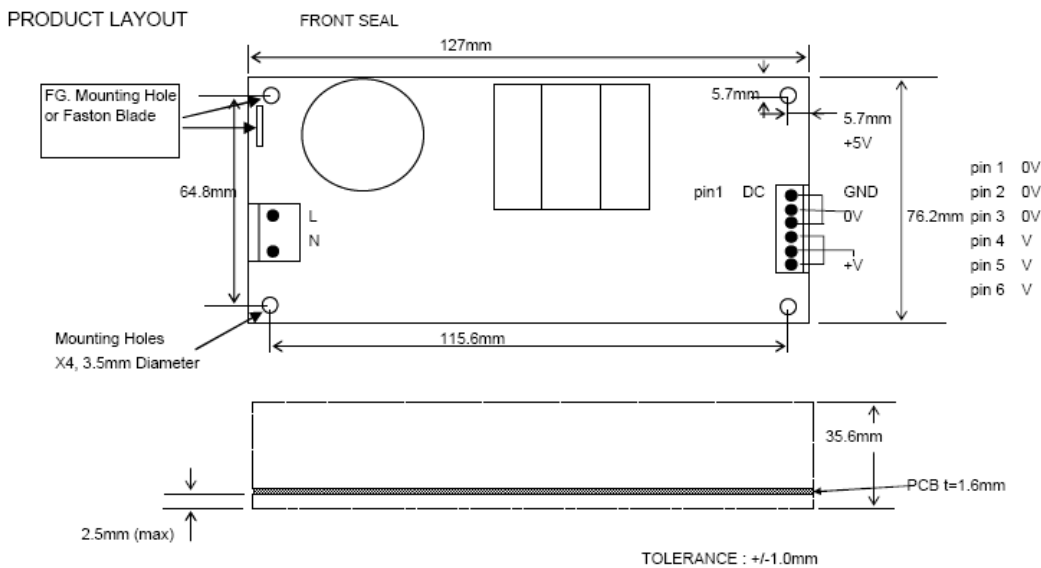

Mounting Method:

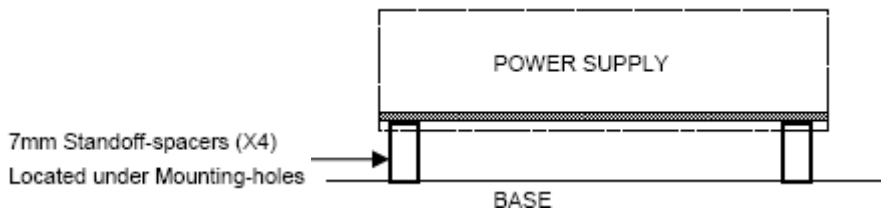

Connector Types:

AC Housing: Molex 09-50-3031
DC Housing: Molex 09-50-3061

Crimp Terminals: Molex 08-50-0105
Crimp Terminals: Molex 08-50-0105

RoHS Compliance: As of manufacturing date February 2005, all standard products meet the requirements of 2011/65/EU, known as the RoHS initiative.

* Upon printing, this document is considered "uncontrolled". Please contact Triad Magnetics' website for the most current version.