



Chipsmall Limited consists of a professional team with an average of over 10 year of expertise in the distribution of electronic components. Based in Hongkong, we have already established firm and mutual-benefit business relationships with customers from,Europe,America and south Asia,supplying obsolete and hard-to-find components to meet their specific needs.

With the principle of “Quality Parts,Customers Priority,Honest Operation,and Considerate Service”,our business mainly focus on the distribution of electronic components. Line cards we deal with include Microchip,ALPS,ROHM,Xilinx,Pulse,ON,Everlight and Freescale. Main products comprise IC,Modules,Potentiometer,IC Socket,Relay,Connector.Our parts cover such applications as commercial,industrial, and automotives areas.

We are looking forward to setting up business relationship with you and hope to provide you with the best service and solution. Let us make a better world for our industry!



Contact us

Tel: +86-755-8981 8866 Fax: +86-755-8427 6832

Email & Skype: info@chipsmall.com Web: www.chipsmall.com

Address: A1208, Overseas Decoration Building, #122 Zhenhua RD., Futian, Shenzhen, China





**Low profile:
15.7mm .618inch height
1a/1c 16A power relay**

LZ RELAYS (ALZ)



RoHS compliant

Protective construction: Flux-resistant type

FEATURES

- 1. Low profile type with height of 15.7 mm .618 inch**
Slim, low profile type with dimensions of 28.8 (L) × 12.5 (W) × 15.7 (H) mm 1.134 (L) × .492 (W) × .618 (H) inch.
- 2. High insulation resistance**
Superior insulation characteristics have been achieved by maintaining an insulation distance between coil and contacts of at least 10 mm for both creepage distance and clearances. Furthermore, anti-surge voltage is 10 kV and higher. (Supports European reinforced insulation requirement.)
- 3. Superior heat resistance**
Can be used in ambient temperatures up to 85°C 185°F for the class B and 105°C 221°F for the class F.
- 4. Low operating power**
Power saved with a nominal operating power of only 400 mW.

- 5. Conforms to the various safety standards:**
UL/C-UL, VDE approved.
- 6. Superior heat resistance and tracking resistance**
EN60335-1 GWT compliant (Tested by VDE) type available

TYPICAL APPLICATIONS

- 1. Household electrical appliances**
TV, CATV, Audio equipment, Microwave ovens, and Heaters, etc.
- 2. Office equipment**
Copy machines, Packaged air conditioners, and Vending machines
- 3. Industrial equipment**
Machine tools, Robots, and Temperature controllers

ORDERING INFORMATION

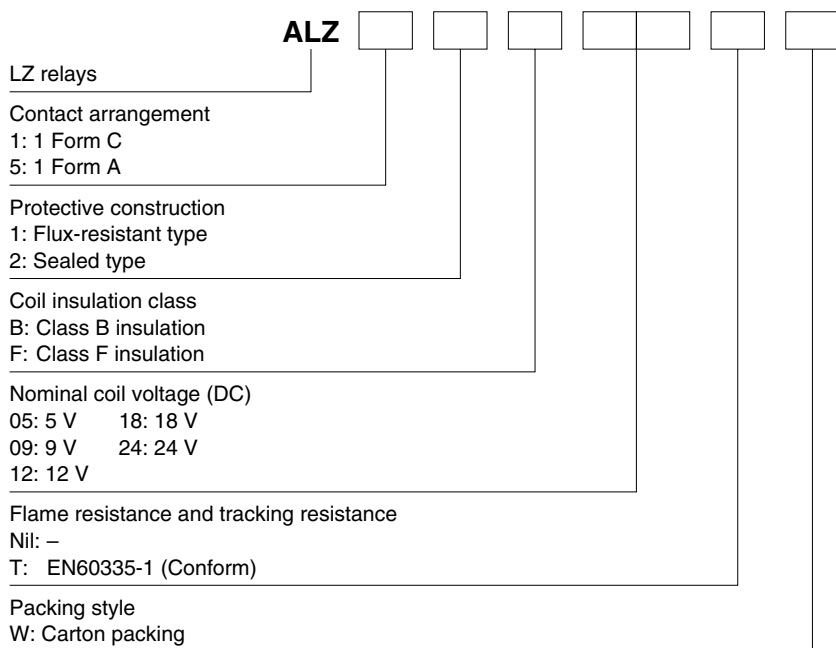

Notes: 1. Certified by UL/C-UL and VDE
2. Tube packing type is also available. Please consult us.

TYPES

| Contact arrangement | Coil voltage | Flux-resistant type | | Sealed type | |
|---------------------|--------------|---------------------|--------------------|--------------------|--------------------|
| | | Class B insulation | Class F insulation | Class B insulation | Class F insulation |
| | | Part No. | Part No. | Part No. | Part No. |
| 1 Form C | 5 V DC | ALZ11B05W | ALZ11F05W | ALZ12B05W | ALZ12F05W |
| | 9 V DC | ALZ11B09W | ALZ11F09W | ALZ12B09W | ALZ12F09W |
| | 12 V DC | ALZ11B12W | ALZ11F12W | ALZ12B12W | ALZ12F12W |
| | 18 V DC | ALZ11B18W | ALZ11F18W | ALZ12B18W | ALZ12F18W |
| | 24 V DC | ALZ11B24W | ALZ11F24W | ALZ12B24W | ALZ12F24W |
| 1 Form A | 5 V DC | ALZ51B05W | ALZ51F05W | ALZ52B05W | ALZ52F05W |
| | 9 V DC | ALZ51B09W | ALZ51F09W | ALZ52B09W | ALZ52F09W |
| | 12 V DC | ALZ51B12W | ALZ51F12W | ALZ52B12W | ALZ52F12W |
| | 18 V DC | ALZ51B18W | ALZ51F18W | ALZ52B18W | ALZ52F18W |
| | 24 V DC | ALZ51B24W | ALZ51F24W | ALZ52B24W | ALZ52F24W |

Standard packing: Carton: 100 pcs.; Case: 500 pcs.

Notes: 1. Tube packing type is also available. Please consult us.

2. Carton packing symbol "W" is not marked on the relay.

3. EN60335-1 GWT compliant types available. When ordering, please add suffix "T".

Ex. ALZ51F12TW

RATING

1. Coil data

| Nominal coil voltage | Pick-up voltage (at 20°C 68°F) | Drop-out voltage (at 20°C 68°F) | Nominal operating current [$\pm 10\%$] (at 20°C 68°F) | Coil resistance [$\pm 10\%$] (at 20°C 68°F) | Nominal operating power (at 20°C 68°F) | Max. applied voltage (at 20°C 68°F) |
|----------------------|-------------------------------------|-------------------------------------|---|---|--|-------------------------------------|
| 5 V DC | Max. 70%V nominal voltage (Initial) | Min. 10%V nominal voltage (Initial) | 80 mA | 63 Ω | 400 mW | 130%V of nominal voltage |
| 9 V DC | | | 44.4 mA | 203 Ω | | |
| 12 V DC | | | 33.3 mA | 360 Ω | | |
| 18 V DC | | | 22.2 mA | 810 Ω | | |
| 24 V DC | | | 16.7 mA | 1,440 Ω | | |

2. Specifications

| Characteristics | Item | Specifications | |
|--|---|---|--|
| Contact | Arrangement | 1 Form C, 1 Form A | |
| | Contact resistance (Initial) | Max. 100 m Ω (By voltage drop 6V DC 1A) | |
| | Contact material | AgSnO ₂ type | |
| Rating | Nominal switching capacity (resistive load) | 16A 250V AC | |
| | Max. switching power (resistive load) | 4,000V A | |
| | Max. switching voltage | 440V AC | |
| | Max. switching current | 16A | |
| | Nominal operating power | 400mW | |
| | Min. switching capacity (reference value)*1 | 100mA 5V DC | |
| Electrical characteristics | Insulation resistance (Initial) | Min. 1,000 M Ω (at 500V DC) Measurement at same location as "Breakdown voltage" section. | |
| | Breakdown voltage (Initial) | Between open contacts | 1,000 Vrms for 1 min. (Detection current: 10mA) |
| | | Between contacts and coil | 5,000 Vrms for 1 min. (Detection current: 10mA) |
| | Temperature rise (coil) | Max. 55°C 131°F [with nominal coil voltage and at 16A contact carrying current (resistance method) at 20°C 68°F] | |
| | Surge breakdown voltage*2 (Between contacts and coil) (Initial) | 10,000 V | |
| | Operate time (at nominal voltage) (at 20°C 68°F) | Max. 15ms (excluding contact bounce time) | |
| Release time (at nominal voltage) (at 20°C 68°F) | Max. 5ms (excluding contact bounce time, without diode) | | |
| Mechanical characteristics | Shock resistance | Functional | 100 m/s ² (Half-wave pulse of sine wave: 11ms; detection time: 10 μ s) |
| | | Destructive | 1,000 m/s ² (Half-wave pulse of sine wave: 6ms) |
| | Vibration resistance | Functional | 10 to 55Hz at double amplitude of 1.5mm (Detection time: 10 μ s) (Only the N.C. side of 1 Form C is 0.8mm) |
| | | Destructive | 10 to 55Hz at double amplitude of 1.5mm |
| Expected life | Mechanical (at 180 times/min.) | Min. 10 ⁷ | |
| | Electrical (at 20 times/min.)*3 | N.O.: Min. 10 ⁵ , N.C.: Min. 5 × 10 ⁴ | |
| Conditions | Conditions for operation, transport and storage*4, *5 | Ambient temperature: -40°C to +85°C -40°F to +185°F (Class B), Humidity: 5 to 85% R.H. (Not freezing and condensing at low temperature) | |
| | Max. operating speed | 20 times/min. (at nominal switching capacity) | |
| Unit weight | | Approx. 12 g .42 oz | |

Notes: *1. This value can change due to the switching frequency, environmental conditions, and desired reliability level, therefore it is recommended to check this with the actual load.

*2. Wave is standard shock voltage of $\pm 1.2 \times 50\mu$ s according to JEC-212-1981.

*3. In order to obtain the full rated life cycles, the relay should be properly vented by removing the vent nib. More detail, please look at caution for NOTES.

*4. Class F type is ambient temperature 105°C 221°F.

*5. The upper limit of the ambient temperature is the maximum temperature that can satisfy the coil temperature rise value. Refer to Usage, transport and storage conditions in NOTES.

*Please note that some of the specifications listed above may not comply with overseas standards.

REFERENCE DATA

1. Max. switching power (AC resistive load)

2. Max. switching power (DC resistive load)

3. Coil temperature rise
 Sample: ALZ11F12, 5pcs.
 Measured portion: coil inside
 Contact current: 0 A, 16 A

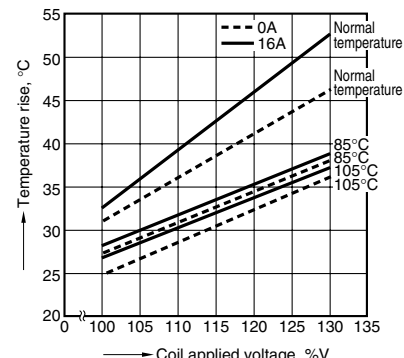
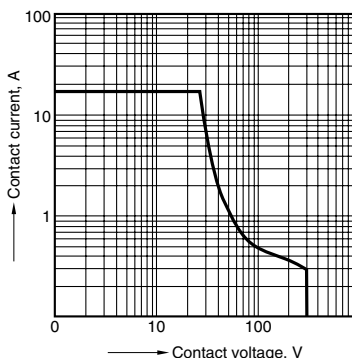
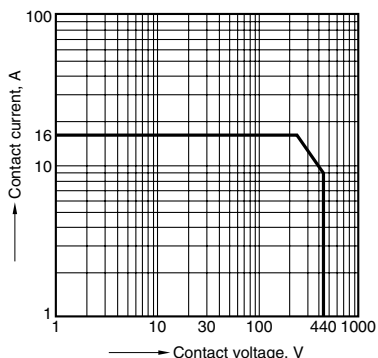

DIMENSIONS (mm inch)

The CAD data of the products with a **CAD Data** mark can be downloaded from: <http://industrial.panasonic.com/ac/e/>

1.1 Form A type

CAD Data



External dimensions

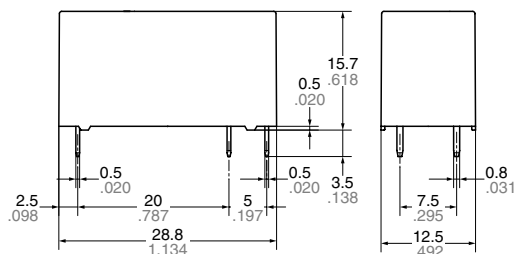

PC board pattern

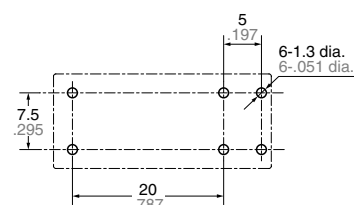

Tolerance: $\pm 0.1 \pm 0.004$

Schematic (Bottom view)

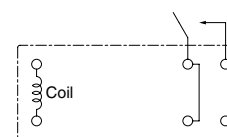

| | |
|--|---------------------|
| Dimension: | Tolerance |
| Less than 1mm .039inch: | $\pm 0.1 \pm 0.004$ |
| Min. 1mm .039inch less than 3mm .118 inch: | $\pm 0.2 \pm 0.008$ |
| Min. 3mm .118 inch: | $\pm 0.3 \pm 0.012$ |

2.1 Form C type

CAD Data



External dimensions

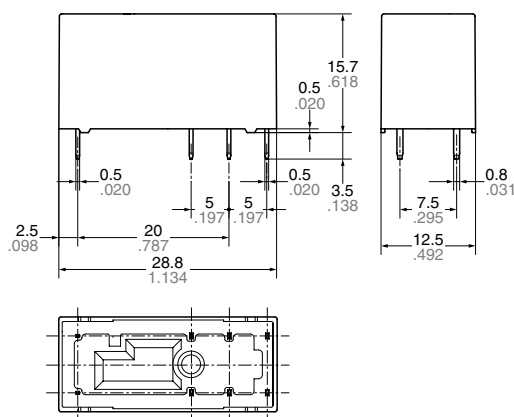

PC board pattern

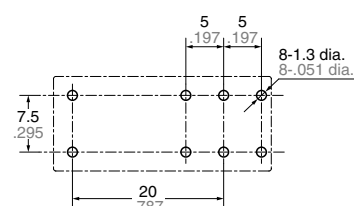

Tolerance: $\pm 0.1 \pm 0.004$

Schematic (Bottom view)

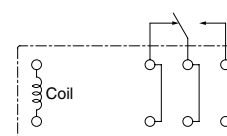

| | |
|--|---------------------|
| Dimension: | Tolerance |
| Less than 1mm .039inch: | $\pm 0.1 \pm 0.004$ |
| Min. 1mm .039inch less than 3mm .118 inch: | $\pm 0.2 \pm 0.008$ |
| Min. 3mm .118 inch: | $\pm 0.3 \pm 0.012$ |

SAFETY STANDARDS

| UL/C-UL (Recognized) | | VDE (Certified) | | TV rating (UL/CSA) | |
|----------------------|---|-----------------|-------------------------------|--------------------|--------|
| File No. | Contact rating | File No. | Contact rating | File No. | Rating |
| E43149 | 16A 277V AC, 34.8LRA/7.2FLA/120V AC, 15LRA/3FLA/120V AC 10LRA/3FLA 240V AC, 20A 240V AC (N.O. only) 16A 30V DC, 25A 240V AC, 15A 240V AC Resistive load 105°C 221°F (N.O. only) | 40000380 | 16A 250V AC (cos ϕ =1.0) | C-UL E43149 | TV-5 |

* CSA standard: Certified by C-UL

NOTES

1. For cautions for use, please read

“GENERAL APPLICATION

GUIDELINES” on page B-1.

2. Electrical life (Sealed type)

In order to obtain the full rated life cycles, the relay should be properly vented by removing the vent nib after the soldering/washing process.

