



Chipsmall Limited consists of a professional team with an average of over 10 year of expertise in the distribution of electronic components. Based in Hongkong, we have already established firm and mutual-benefit business relationships with customers from,Europe,America and south Asia,supplying obsolete and hard-to-find components to meet their specific needs.

With the principle of “Quality Parts,Customers Priority,Honest Operation,and Considerate Service”,our business mainly focus on the distribution of electronic components. Line cards we deal with include Microchip,ALPS,ROHM,Xilinx,Pulse,ON,Everlight and Freescale. Main products comprise IC,Modules,Potentiometer,IC Socket,Relay,Connector.Our parts cover such applications as commercial,industrial, and automotives areas.

We are looking forward to setting up business relationship with you and hope to provide you with the best service and solution. Let us make a better world for our industry!



Contact us

Tel: +86-755-8981 8866 Fax: +86-755-8427 6832

Email & Skype: info@chipsmall.com Web: www.chipsmall.com

Address: A1208, Overseas Decoration Building, #122 Zhenhua RD., Futian, Shenzhen, China



HW100F and HW100A Power Modules: dc-dc Converters; 36 Vdc to 75 Vdc Input, 3.3 Vdc or 5 Vdc Output; 100 W

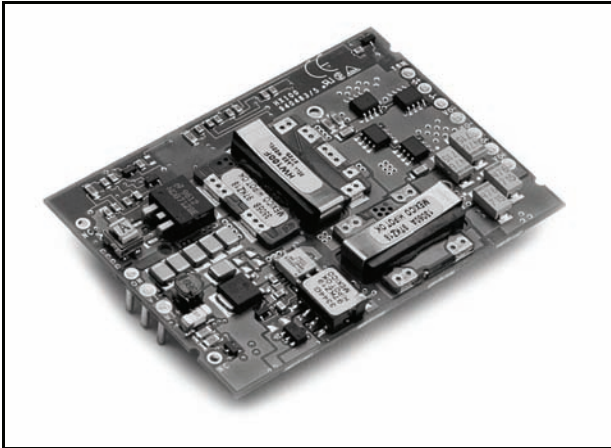

The HW100 Series Power Modules use advanced surface-mount technology and deliver high-quality, efficient, and compact dc-dc conversion.

Applications

- Distributed power architectures
- Telecommunications
- Electronic data processing
- Workstations

Options

- Choice of remote on/off logic configuration

Description

The HW100 Series Power Modules are open frame (no case, no potting) dc-dc converters that operate over an input voltage range of 36 Vdc to 75 Vdc and provide a precisely regulated dc output. The outputs are fully isolated from the inputs, allowing versatile polarity configurations and grounding connections. The modules have a maximum power rating of 100 W at a typical full-load efficiency of 90%.

Features

- Low profile: 10.7 mm (0.42 in.)
- Small size: 83.8 mm x 59.7 mm x 10.7 mm (3.30 in. x 2.35 in. x 0.42 in.)
- High power density
- High efficiency: 90% typical
- Low noise, low EMI
- Constant frequency
- Open frame design; no case or potting
- 2:1 input voltage range
- Overvoltage and overcurrent protection
- Overtemperature protection
- Remote sense
- Remote on/off
- Adjustable output voltage
- ISO9001 and ISO14001 Certified manufacturing facilities
- *UL** 1950 Recognized, *CSA*† C22.2 No. 950-95 Certified, VDE 0805 (EN60950, IEC950) Licensed
- CE mark meets 73/23/EEC and 93/68/EEC directives‡

* *UL* is a registered trademark of Underwriters Laboratories, Inc.

† *CSA* is a registered trademark of Canadian Standards Assn.

‡ This product is intended for integration into end-use equipment. All the required procedures for CE marking of end-use equipment should be followed. (The CE mark is placed on selected products.)

Absolute Maximum Ratings

Stresses in excess of the absolute maximum ratings can cause permanent damage to the device. These are absolute stress ratings only. Functional operation of the device is not implied at these or any other conditions in excess of those given in the operations sections of the data sheet. Exposure to absolute maximum ratings for extended periods can adversely affect device reliability.

Parameter	Symbol	Min	Max	Unit
Input Voltage: Continuous	V_I	—	75	Vdc
Transient	V_I	—	100	V
Operating Ambient Temperature (See Thermal Considerations section.)	T_A	-40	85*	°C
Storage Temperature	T_{stg}	-55	125	°C
I/O Isolation Voltage	—	—	1500	Vdc

* With derated output power. See Thermal Considerations section.

Electrical Specifications

Unless otherwise indicated, specifications apply over all operating input voltage, resistive load, and temperature conditions.

Table 1. Input Specifications

Parameter	Symbol	Min	Typ	Max	Unit
Operating Input Voltage	V_I	36	48	75	Vdc
Maximum Input Current ($V_I = 0\text{ V to }75\text{ V}$; $I_O = I_{O, max}$)	$I_{I, max}$	—	—	3.5	A
Inrush Transient	i^2t	—	—	2.0	A ² s
Input Reflected-ripple Current, Peak-to-peak (5 Hz to 20 MHz, 12 μ H source impedance; see Figure 8.)	—	—	—	100	mA _{p-p}
Input Ripple Rejection (120 Hz)	—	—	60	—	dB

Fusing Considerations

This power module is internally fused in the $V_I(+)$ leg.

Electrical Specifications (continued)

Table 2. Output Specifications

Parameter	Device	Symbol	Min	Typ	Max	Unit
Output Voltage Set Point ($V_I = 48\text{ V}$; $I_O = I_{O, \text{max}}$; $T_A = 25\text{ }^\circ\text{C}$)	F	$V_{O, \text{set}}$	3.25	3.3	3.35	Vdc
	A	$V_{O, \text{set}}$	4.92	5.0	5.08	Vdc
Output Voltage (Over all operating input voltage, resistive load, and temperature conditions until end of life. See Figure 10.)	F	V_O	3.20	—	3.40	Vdc
	A	V_O	4.85	—	5.15	Vdc
Output Regulation: Line ($V_I = 36\text{ V}$ to 75 V) Load ($I_O = I_{O, \text{min}}$ to $I_{O, \text{max}}$) Temperature ($T_A = -40\text{ }^\circ\text{C}$ to $+50\text{ }^\circ\text{C}$)	All	—	—	0.01	0.2	% V_O
	All	—	—	0.05	0.2	% V_O
	All	—	—	15	50	mV
Output Ripple and Noise Voltage (See Figure 9.): RMS Peak-to-peak (5 Hz to 20 MHz)	All	—	—	—	50	mVrms
	All	—	—	—	100	mVp-p
External Load Capacitance	All	—	0	—	—*	μF
Output Current (At $I_O < I_{O, \text{min}}$, the modules may exceed output ripple specifications.)	F	I_O	0.5	—	20	A
	A	I_O	0.5	—	20	A
Output Current-limit Inception (Shutdown threshold; see Electrical Descriptions section.)	F	$I_{O, \text{cli}}$	—	—	28 [†]	A
	A	$I_{O, \text{cli}}$	—	—	28 [†]	A
Efficiency ($V_I = 48\text{ V}$; $I_O = I_{O, \text{max}}$; $T_A = 25\text{ }^\circ\text{C}$)	F	η	—	88	—	%
	A	η	—	90	—	%
Switching Frequency	All	—	—	300	—	kHz
Dynamic Response ($\dot{I}_O/\dot{I}_T = 1\text{ A}/10\text{ } \mu\text{s}$, $V_I = 48\text{ V}$, $T_A = 25\text{ }^\circ\text{C}$; tested without any load capacitance.): Load Change from $I_O = 50\%$ to 75% of $I_{O, \text{max}}$: Peak Deviation Settling Time ($V_O < 10\%$ of peak deviation) Load Change from $I_O = 50\%$ to 25% of $I_{O, \text{max}}$: Peak Deviation Settling Time ($V_O < 10\%$ of peak deviation)	All	—	—	8	—	% $V_{O, \text{set}}$
	All	—	—	300	—	μs
	All	—	—	8	—	% $V_{O, \text{set}}$
	All	—	—	300	—	μs

* Please consult your sales representative or the factory.

† These are manufacturing test limits. In some situations, results may differ.

Table 3. Isolation Specifications

Parameter	Min	Typ	Max	Unit
Isolation Capacitance	—	2000	—	pF
Isolation Resistance	10	—	—	M Ω

General Specifications

Parameter	Min	Typ	Max	Unit
Calculated MTBF ($I_o = 80\%$ of $I_{o, max}$; $T_A = 20\text{ }^\circ\text{C}$)	2,800,000			hours
Weight	—	—	50 (1.8)	g (oz.)

Solder Ball and Cleanliness Requirements

The open frame (no case or potting) power module will meet the solder ball requirements per J-STD-001B. These requirements state that solder balls must neither be loose nor violate the power module minimum electrical spacing.

The cleanliness designator of the open frame power module is C00 (per J specification).

Feature Specifications

Unless otherwise indicated, specifications apply over all operating input voltage, resistive load, and temperature conditions. See Feature Descriptions for additional information.

Parameter	Device	Symbol	Min	Typ	Max	Unit
Remote On/Off Signal Interface ($V_i = 0\text{ V}$ to 75 V ; open collector or equivalent compatible; signal referenced to $V_i(-)$ terminal; see Figure 11 and Feature Descriptions.): HW100x1 Preferred Logic: Logic Low—Module On Logic High—Module Off HW100x Optional Logic: Logic Low—Module Off Logic High—Module On Logic Low: At $I_{on/off} = 1.0\text{ mA}$ At $V_{on/off} = 0.0\text{ V}$ Logic High: At $I_{on/off} = 0.0\text{ }\mu\text{A}$ Leakage Current Turn-on Time ($I_o = 80\%$ of $I_{o, max}$; V_o within $\pm 1\%$ of steady state; see Figure 7.)	All	$V_{on/off}$	0	—	1.2	V
	All	$I_{on/off}$	—	—	1.0	mA
	All	$V_{on/off}$	—	—	15	V
	All	$I_{on/off}$	—	—	50	μA
	All	—	10	30	50*	ms
Output Voltage Adjustment (See Feature Descriptions.): Output Voltage Remote-sense Range Output Voltage Set-point Adjustment Range (trim)	All	—	—	—	0.5	V
	F	—	90	—	110	$\%V_{O, nom}$
	A	—	60	—	110	$\%V_{O, nom}$
Output Overvoltage Protection (shutdown)	F	$V_{O, sd}$	4.0*	—	5.5*	V
	A	$V_{O, sd}$	5.6*	—	7.0*	V

* These are manufacturing test limits. In some situations, results may differ.

Characteristic Curves

The following figures provide typical characteristics for the power modules. The figures are identical for both on/off configurations.

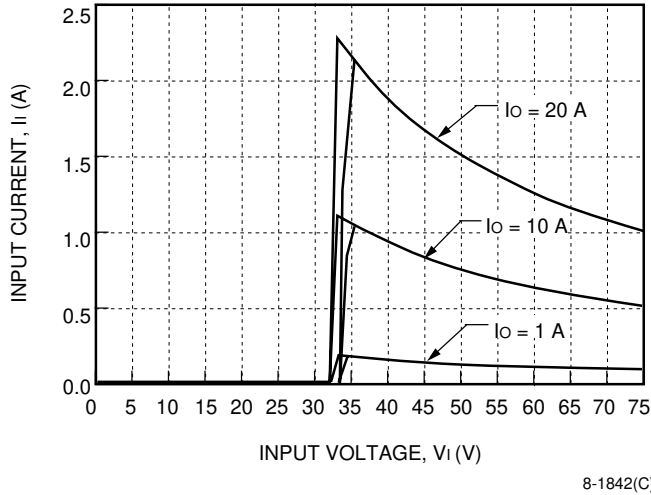

Figure 1. Typical HW100F1 Input Characteristics at Room Temperature

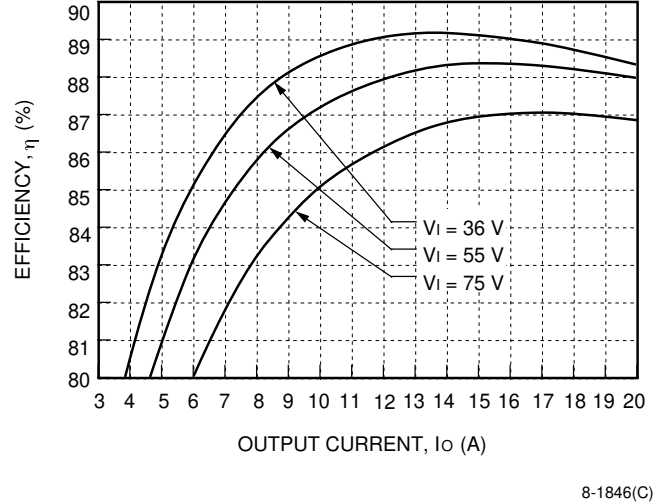

Figure 3. Typical HW100F1 Converter Efficiency vs. Output Current at Room Temperature

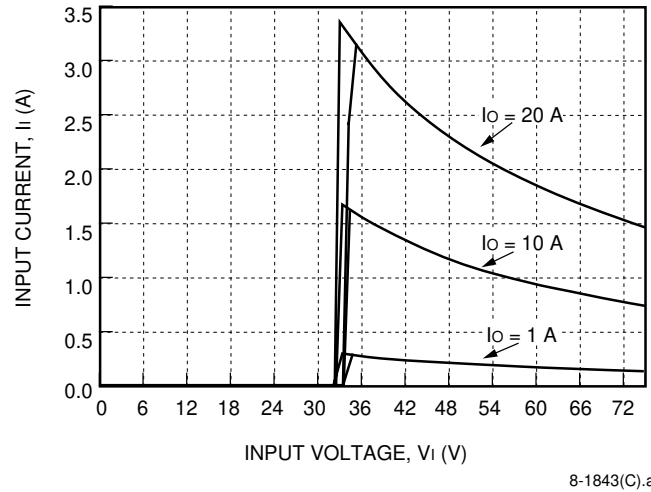

Figure 2. Typical HW100A1 Input Characteristics at Room Temperature

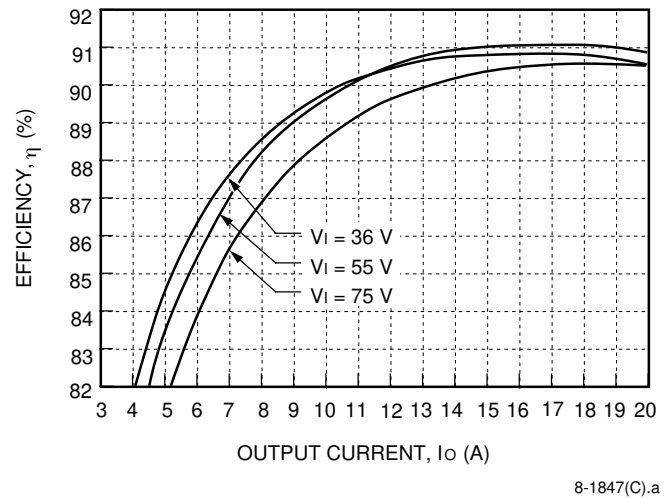
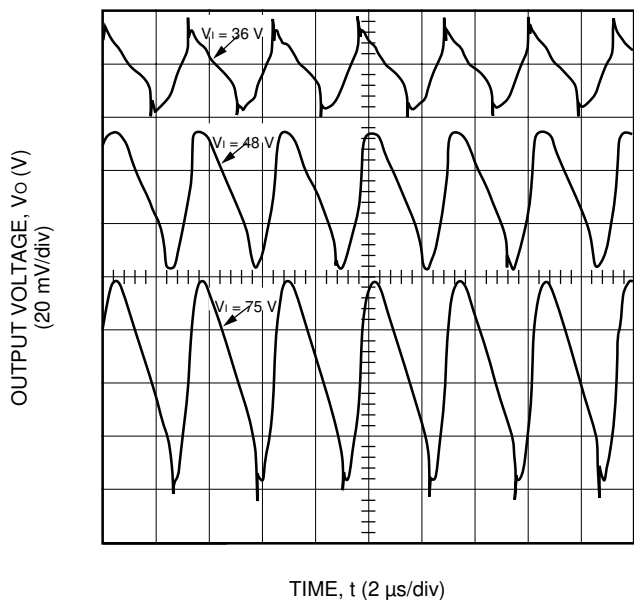

Figure 4. Typical HW100A1 Converter Efficiency vs. Output Current at Room Temperature

Characteristic Curves (continued)



8-2078(C)

Figure 5. Typical HW100F1 Output Ripple Voltage at Room Temperature and $I_o = I_{o,max}$

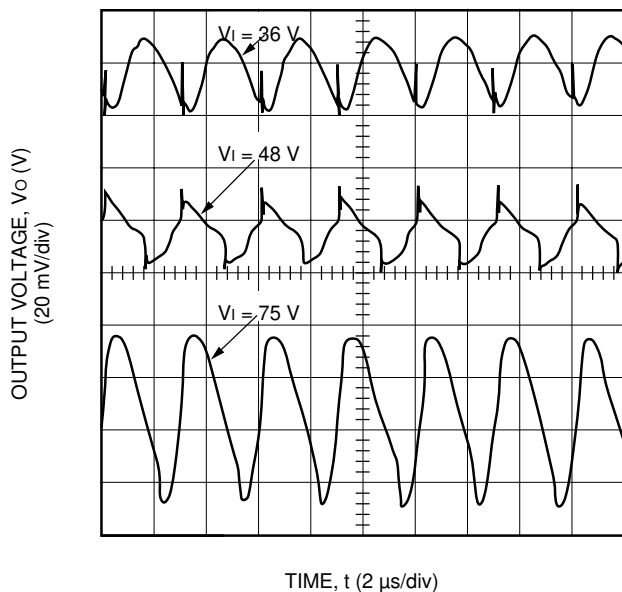

8-2079(C)

Figure 6. Typical HW100A1 Output Ripple Voltage at Room Temperature and $I_o = I_{o,max}$

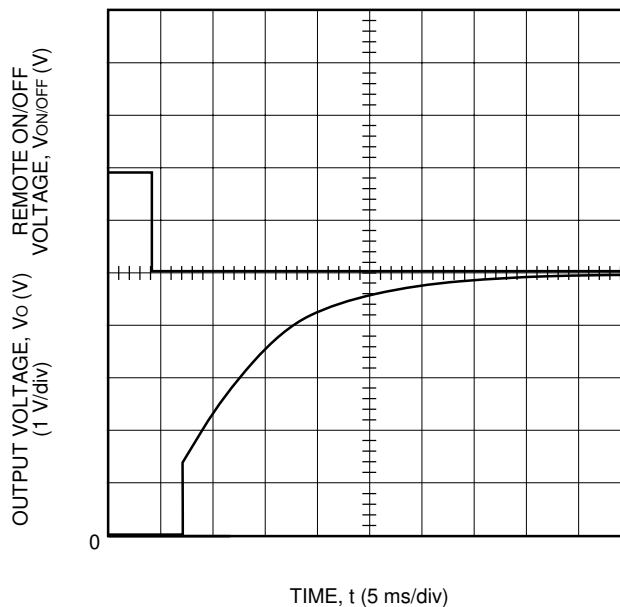

8-1848(C)

Note: Tested without any load capacitance.

Figure 7. Typical Start-Up from Remote On/Off HW100A1; $I_o = I_{o,max}$

Test Configurations

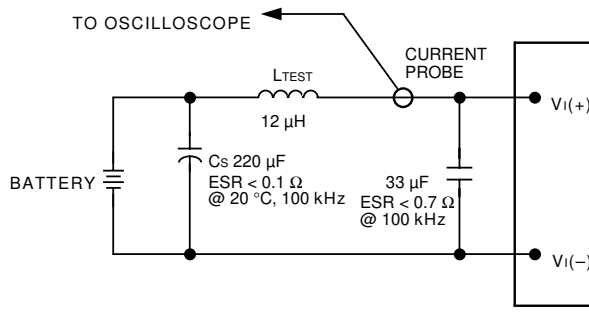

8-203(C).I

Note: Measure input reflected-ripple current with a simulated source inductance (L_{TEST}) of 12 μ H. Capacitor C_s offsets possible battery impedance. Measure current as shown above.

Figure 8. Input Reflected-Ripple Test Setup

Test Configurations (continued)

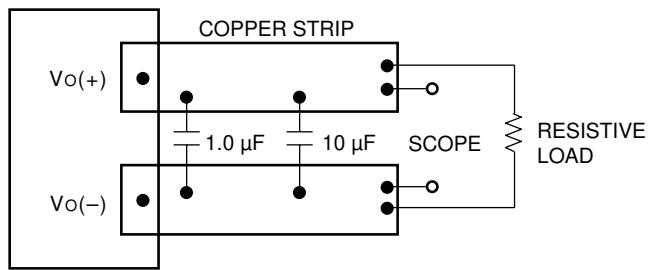

8-513(C).d

Note: Use a 1.0 µF ceramic capacitor and a 10 µF aluminum or tantalum capacitor. Scope measurement should be made using a BNC socket. Position the load between 51 mm and 76 mm (2 in. and 3 in.) from the module.

Figure 9. Peak-to-Peak Output Noise Measurement Test Setup

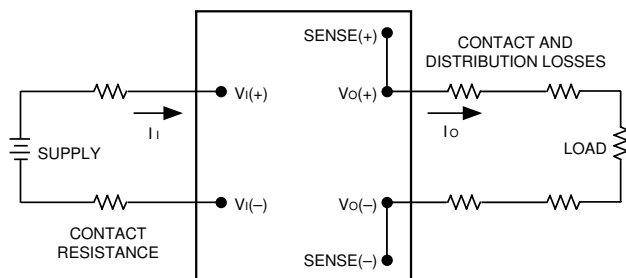

8-749(C)

Note: All measurements are taken at the module terminals. When socketing, place Kelvin connections at module terminals to avoid measurement errors due to socket contact resistance.

$$\eta = \left(\frac{[V_{O(+)} - V_{O(-)}]I_{O}}{[V_{I(+)} - V_{I(-)}]I_{I}} \right) \times 100 \quad \%$$

Figure 10. Output Voltage and Efficiency Measurement Test Setup

Design Considerations

Input Source Impedance

The power module should be connected to a low ac-impedance input source. Highly inductive source impedances can affect the stability of the power module. For the test configuration in Figure 8, a 33 µF electrolytic capacitor (ESR < 0.7 Ω at 100 kHz) mounted close to the power module helps ensure stability of the unit. For other highly inductive source impedances, consult the factory for further application guidelines.

Safety Considerations

For safety-agency approval of the system in which the power module is used, the power module must be installed in compliance with the spacing and separation requirements of the end-use safety agency standard, i.e., *UL 1950*, *CSA C22.2 No. 950-95*, and *VDE 0805 (EN60950, IEC950)*.

If the input source is non-SELV (ELV or a hazardous voltage greater than 60 Vdc and less than or equal to 75 Vdc), for the module's output to be considered meeting the requirements of safety extra-low voltage (SELV), all of the following must be true:

- The input source is to be provided with reinforced insulation from any other hazardous voltages, including the ac mains; and
- One VI pin and one VO pin are to be grounded or both the input and output pins are to be kept floating; and
- The input pins of the module are not operator accessible; and
- Another SELV reliability test is conducted on the whole system, as required by the safety agencies, on the combination of supply source and the subject module to verify that under a single fault, hazardous voltages do not appear at the module's output.

Note: Do not ground either of the input pins of the module without grounding one of the output pins. This may allow a non-SELV voltage to appear between the output pins and ground.

The power module has extra-low voltage (ELV) outputs when all inputs are ELV.

Feature Descriptions

Overcurrent Protection

To provide protection in a fault (output overload) condition, the unit is equipped with internal current-limiting circuitry and can endure current limiting for up to one second. If overcurrent exists for more than one second, the unit will latch in an off condition. The overcurrent latch is reset by either cycling the input power or by toggling the ON/OFF pin for one second. At the point of current-limit inception, the unit shifts from voltage control to current control. If the output voltage is pulled very low during a severe fault, the current-limit circuit can exhibit either foldback or tailout characteristics (output current decrease or increase).

Feature Descriptions (continued)

Remote On/Off

Two remote on/off options are available. Positive logic remote on/off turns the module on during a logic-high voltage on the ON/OFF pin, and off during a logic low. Negative logic remote on/off turns the module off during a logic high and on during a logic low. Negative logic, device code suffix "1," is the factory-preferred configuration.

To turn the power module on and off, the user must supply a switch to control the voltage between the on/off terminal and the $V_{I(-)}$ terminal ($V_{on/off}$). The switch can be an open collector or equivalent (see Figure 11). A logic low is $V_{on/off} = 0$ V to 1.2 V. The maximum $I_{on/off}$ during a logic low is 1 mA. The switch should maintain a logic-low voltage while sinking 1 mA.

During a logic high, the maximum $V_{on/off}$ generated by the power module is 15 V. The maximum allowable leakage current of the switch at $V_{on/off} = 15$ V is 50 μ A.

If not using the remote on/off feature, do one of the following:

- For negative logic, short ON/OFF pin to $V_{I(-)}$.
- For positive logic, leave ON/OFF pin open.

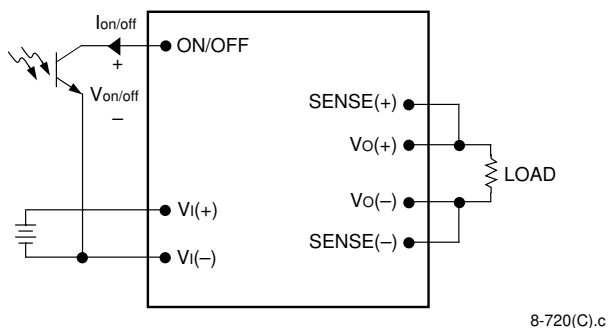

Figure 11. Remote On/Off Implementation

Remote Sense

Remote sense minimizes the effects of distribution losses by regulating the voltage at the remote-sense connections. The voltage between the remote-sense pins and the output terminals must not exceed the output voltage sense range given in the Feature Specifications table, i.e.:

$$[V_{o(+)} - V_{o(-)}] - [SENSE(+)] - SENSE(-)] \leq 0.5 \text{ V}$$

The voltage between the $V_{o(+)}$ and $V_{o(-)}$ terminals must not exceed the minimum output overvoltage shut-down voltage as indicated in the Feature Specifications table. This limit includes any increase in voltage due to remote-sense compensation and output voltage set-point adjustment (trim). See Figure 12.

If not using the remote-sense feature to regulate the output at the point of load, then connect SENSE(+) to $V_{o(+)}$ and SENSE(-) to $V_{o(-)}$ at the module.

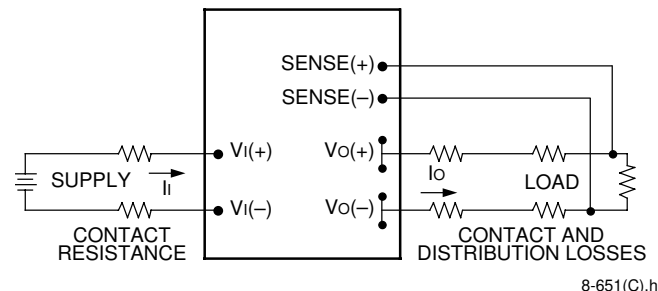

Figure 12. Effective Circuit Configuration for Single-Module Remote-Sense Operation

Output Voltage Set-Point Adjustment (Trim)

Output voltage trim allows the user to increase or decrease the output voltage set point of a module. This is accomplished by connecting an external resistor between the TRIM pin and either the SENSE(+) or SENSE(-) pins. The trim resistor should be positioned close to the module.

If not using the trim feature, leave the TRIM pin open.

With an external resistor between the TRIM and SENSE(-) pins ($R_{adj-down}$), the output voltage set point ($V_{o, adj}$) decreases (see Figure 13). The following equation determines the required external-resistor value to obtain a percentage output voltage change of $\Delta\%$.

$$R_{adj-down} = \left(\frac{510}{\Delta\%} - 10.2 \right) \text{ k}\Omega$$

The test results for this configuration are displayed in Figure 14. This figure applies to all output voltages.

With an external resistor connected between the TRIM and SENSE(+) pins (R_{adj-up}), the output voltage set point ($V_{o, adj}$) increases (see Figure 15).

The following equation determines the required external-resistor value to obtain a percentage output voltage change of $\Delta\%$.

$$R_{adj-up} = \left(\frac{5.1 V_o (100 + \Delta\%)}{1.225 \Delta\%} - \frac{510}{\Delta\%} - 10.2 \right) \text{ k}\Omega$$

Feature Descriptions (continued)

Output Voltage Set-Point Adjustment (Trim)
(continued)

The test results for this configuration are displayed in Figure 16.

The voltage between the Vo(+) and Vo(-) terminals must not exceed the minimum output overvoltage shut-down voltage as indicated in the Feature Specifications table. This limit includes any increase in voltage due to remote-sense compensation and output voltage set-point adjustment (trim). See Figure 12.

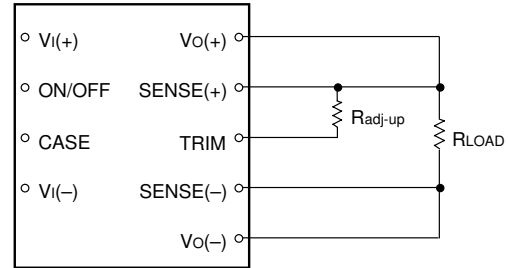

8-715(C).b

Figure 15. Circuit Configuration to Increase Output Voltage

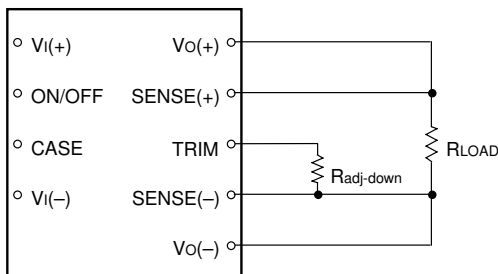

8-748(C).b

Figure 13. Circuit Configuration to Decrease Output Voltage

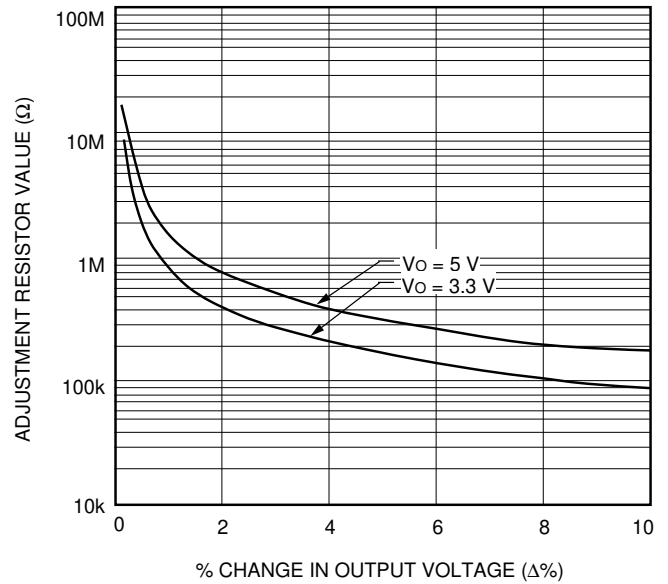

8-2046(C)

Figure 16. Resistor Selection for Increased Output Voltage

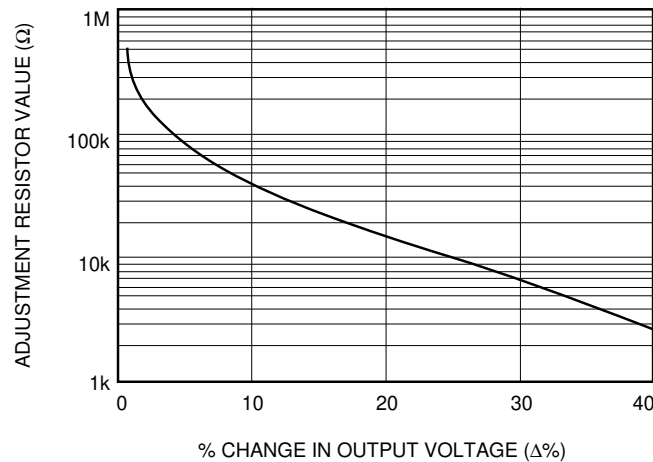

8-2045(C)

Figure 14. Resistor Selection for Decreased Output Voltage

Output Overvoltage Protection

The output overvoltage protection consists of circuitry that monitors the voltage on the output terminals. If the voltage on the output terminals exceeds the overvoltage protection threshold, then the module will shut down and latch off. The overvoltage latch is reset by either cycling the input power for one second or by toggling the ON/OFF pin for one second.

Feature Descriptions (continued)

Overtemperature Protection

To provide protection in a fault condition, the unit is equipped with a thermal shutdown circuit. The shutdown circuit will not engage unless the unit is operated above the maximum device temperature. Recovery for the thermal shutdown is accomplished by cycling the dc input power off for at least one second or toggling the primary referenced on/off signal for at least one second.

Thermal Considerations

The power modules operate in a variety of thermal environments; however, sufficient cooling should be provided to help ensure reliable operation of the unit. Heat is removed by convection and radiation to the surrounding environment.

The thermal data presented is based on measurements taken in a wind tunnel. The test setup shown in Figure 17 was used to collect data for Figures 23 through 26. Note that the orientation of the module with respect to airflow affects thermal performance. Two orientations are shown in Figures 18 and 19.

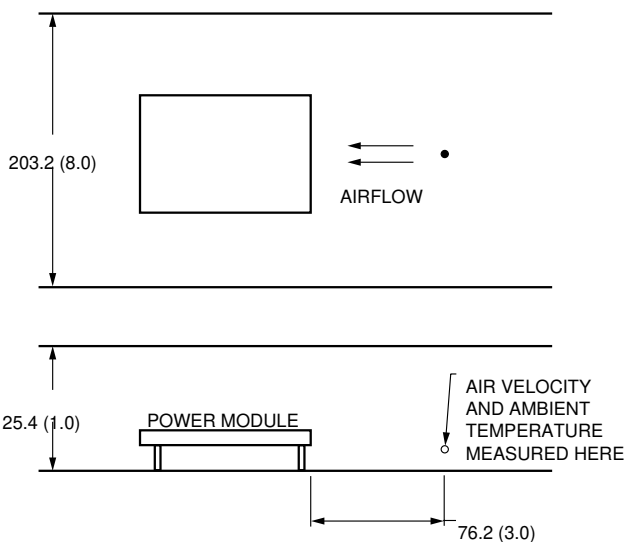

Note: Dimensions are in millimeters and (inches).

Figure 17. Thermal Test Setup

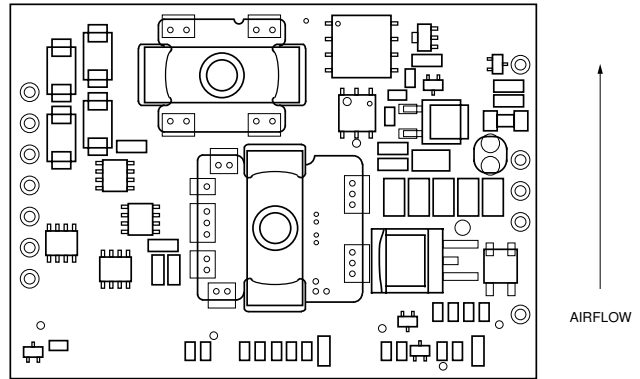

Figure 18. Best Orientation (Top View)

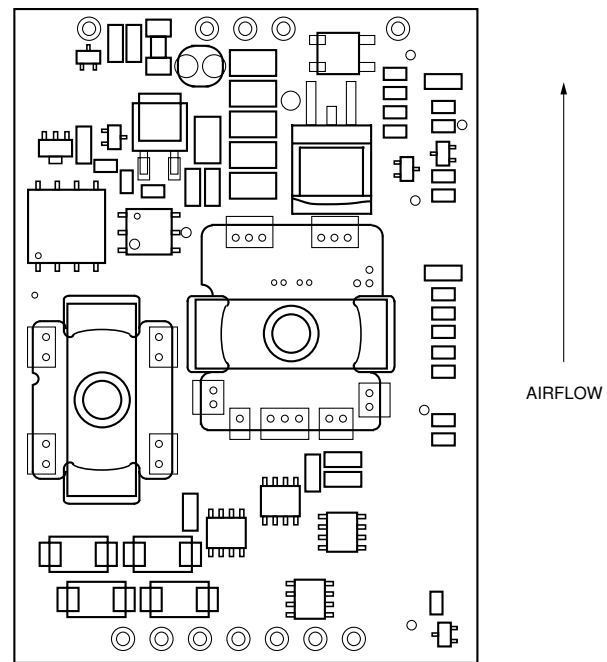

Figure 19. Worst Orientation (Top View)

Proper cooling can be verified by measuring the power module's temperature at the top center of the case of the optocoupler as shown in Figure 20.

Thermal Considerations (continued)

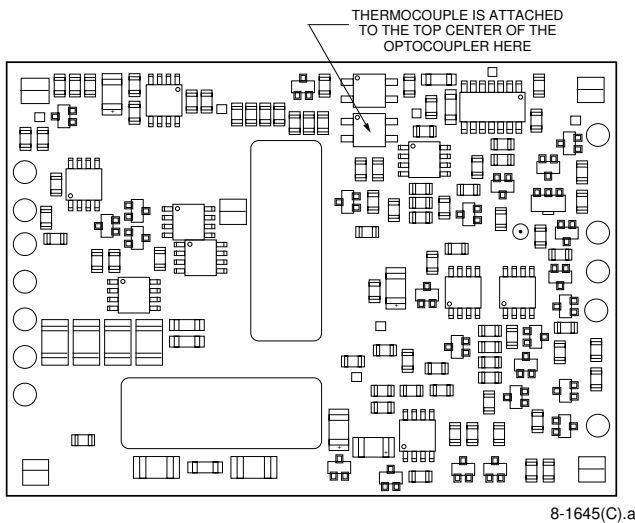

Figure 20. Temperature Measurement Location (Bottom View)

The temperature at this location should not exceed 100 °C. The output power of the module should not exceed the rated power.

Convection Requirements for Cooling

To predict the approximate cooling needed for the module, determine the power dissipated as heat by the unit for the particular application. Figures 21 and 22 show typical heat dissipation for the module over a range of output currents.

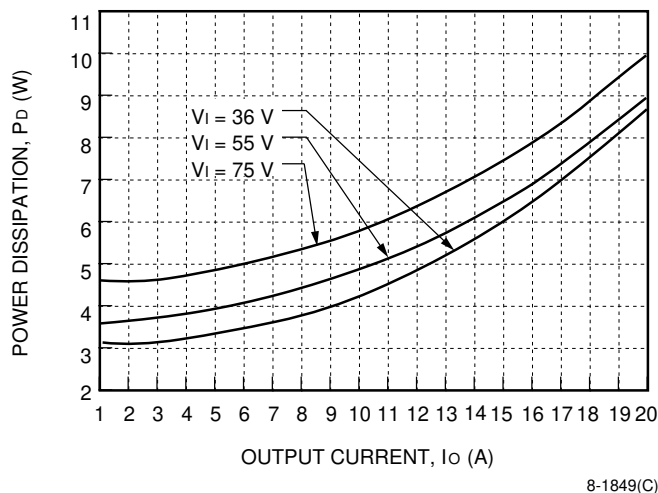

Figure 21. HW100F1 Power Dissipation vs. Output Current, $T_A = 25\text{ °C}$

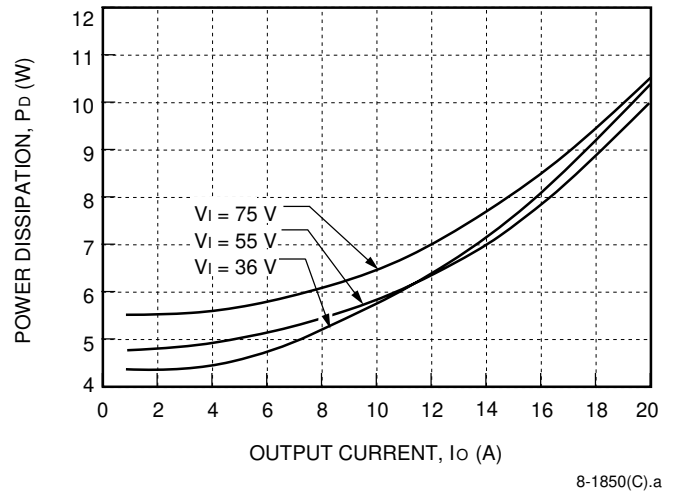

Figure 22. HW100A1 Power Dissipation vs. Output Current, $T_A = 25\text{ °C}$

With the known heat dissipation, module orientation with respect to airflow, and a given local ambient temperature, the minimum airflow can be chosen from the derating curves in Figures 23 through 26.

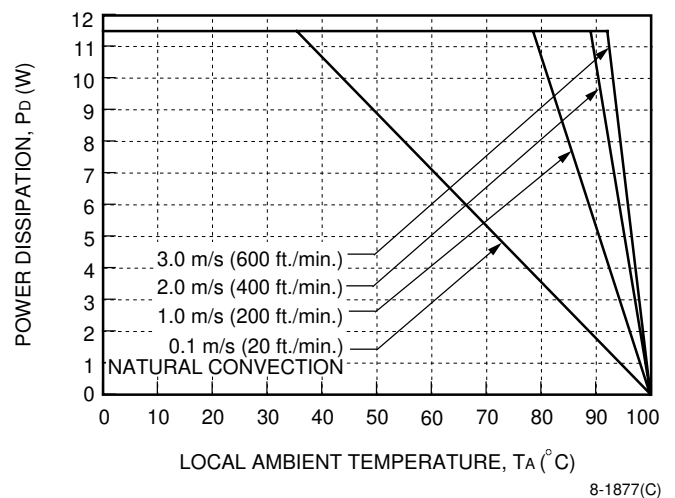

Figure 23. HW100F1 Power Derating vs. Local Ambient Temperature and Air Velocity; Best Orientation

Thermal Considerations (continued)

Convection Requirements for Cooling

(continued)

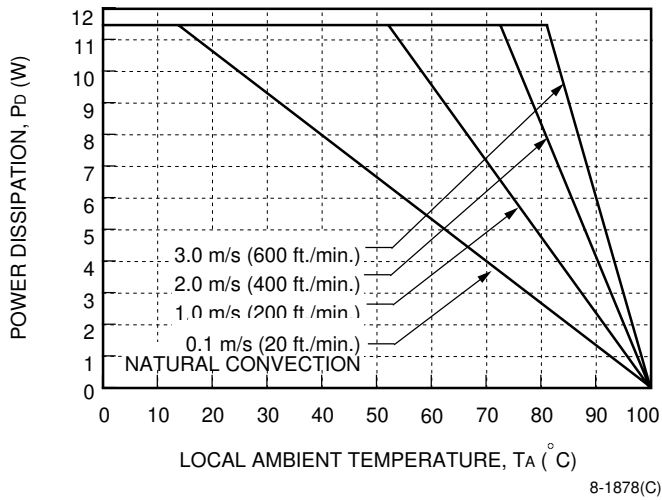

Figure 24. HW100F1 Power Derating vs. Local Ambient Temperature and Air Velocity; Worst Orientation

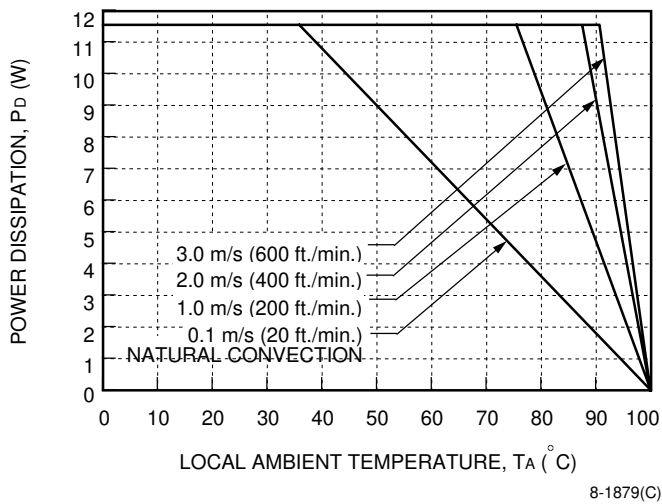

Figure 25. HW100A1 Power Derating vs. Local Ambient Temperature and Air Velocity; Best Orientation

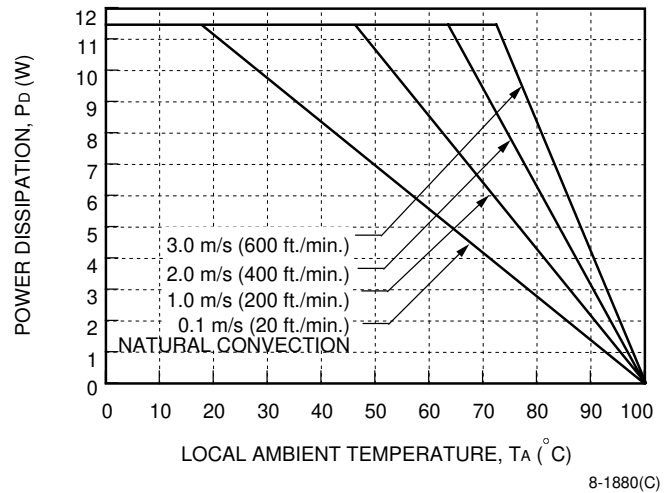

Figure 26. HW100A1 Power Derating vs. Local Ambient Temperature and Air Velocity; Worst Orientation

For example, if the HW100A1 dissipates 10.8 W of heat at 20 A full load, the minimum airflow for best module orientation in a 50 °C environment is 0.5 m/s (100 ft./min.).

Keep in mind that these derating curves are approximations of the ambient temperatures and airflows required to keep the power module temperature below its maximum rating. Once the module is assembled in the actual system, the module's temperature should be checked as shown in Figure 20 to ensure it does not exceed 100 °C.

Solder, Cleaning, and Drying Considerations

Post solder cleaning is usually the final circuit-board assembly process prior to electrical board testing. The result of inadequate circuit-board cleaning and drying can affect both the reliability of a power module and the testability of the finished circuit-board assembly. For guidance on appropriate soldering, cleaning, and drying procedures, refer to the *Board-Mounted Power Modules: Soldering and Cleaning* Application Note (AP97-021EPS).

EMC Considerations

For assistance with designing for EMC compliance, refer to the *FLTR100V10 Filter Module Data Sheet* (DS98-152EPS).

Layout Considerations

Copper paths must not be routed beneath the power module standoffs. For additional layout guidelines, refer to the *FLTR100V10 Filter Module* Data Sheet (DS98-152EPS).

Outline Diagram

Dimensions are in millimeters and (inches).

Tolerances: x.x mm \pm 0.5 mm (x.xx in. \pm 0.02 in.)
x.xx mm \pm 0.25 mm (x.xxx in. \pm 0.010 in.)

Top View

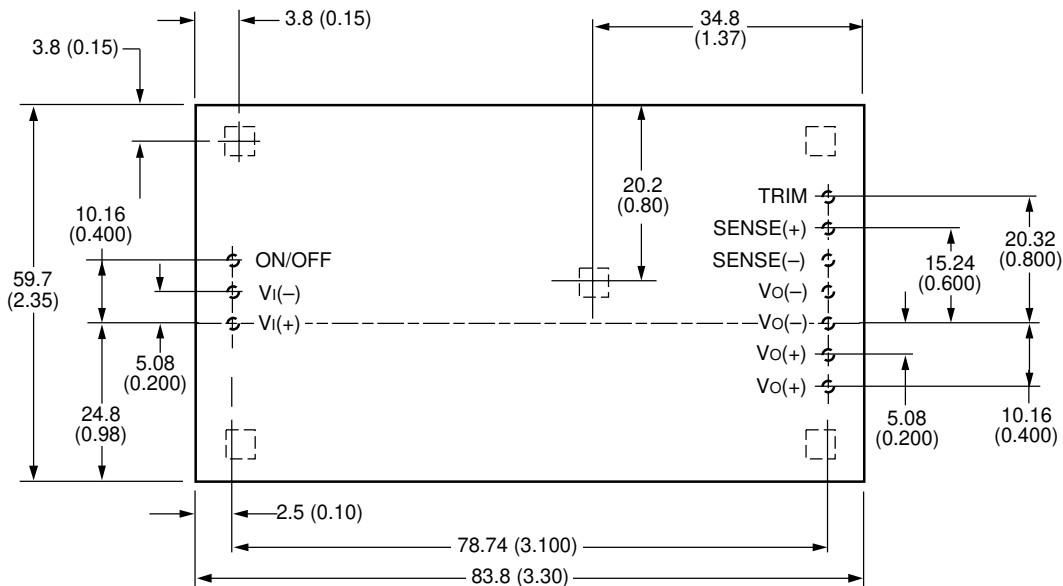

Side View

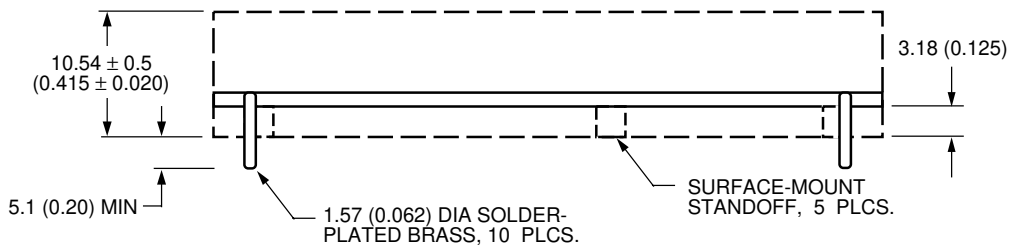

Bottom View

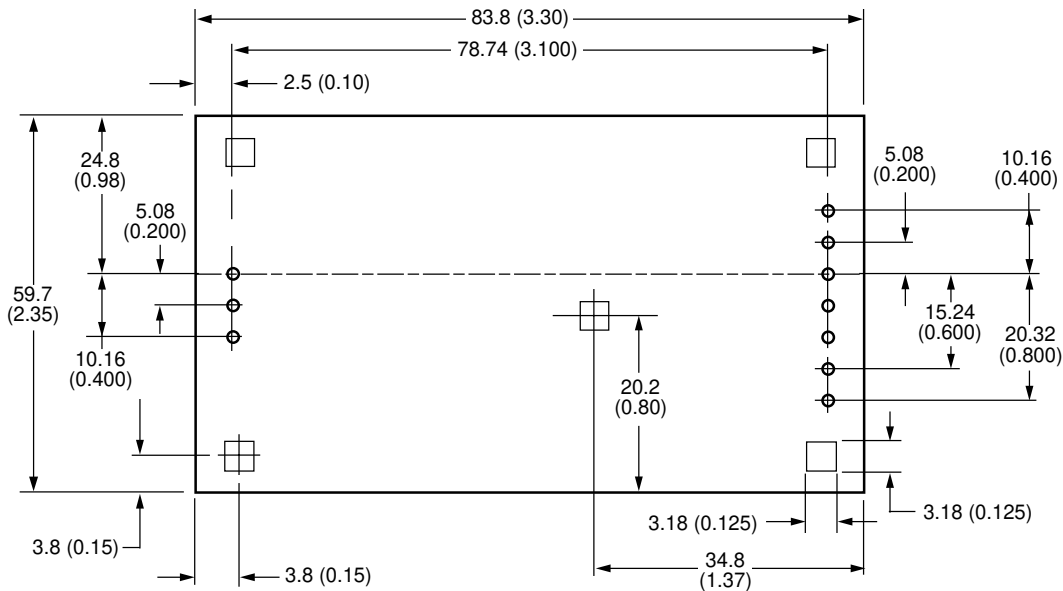

Recommended Hole Pattern

Component-side footprint.

Dimensions are in millimeters and (inches).

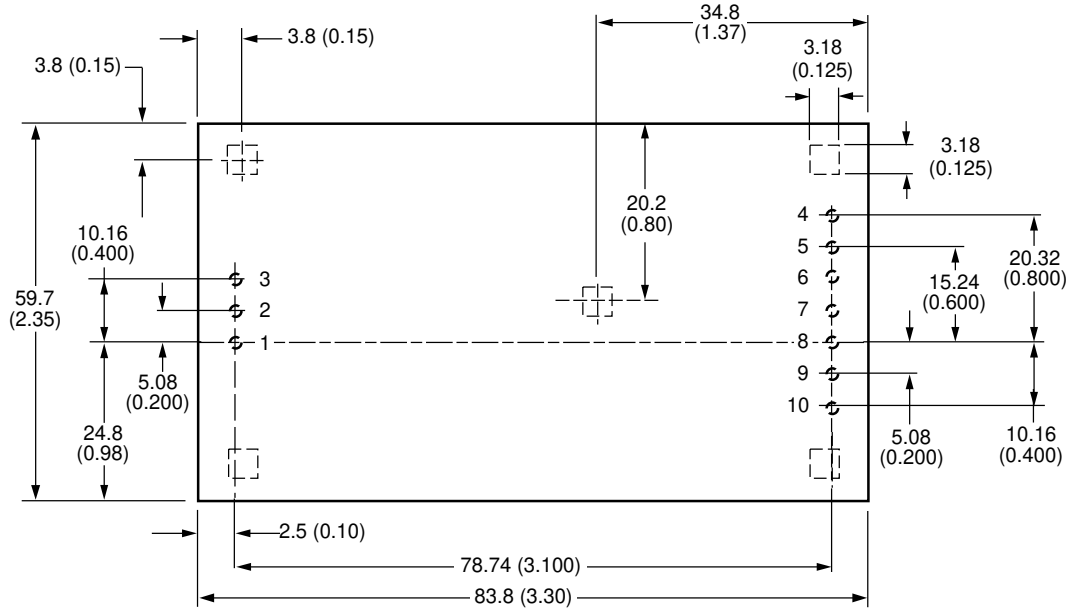

8-1301(C).b

Table 4. Pin Functions

Pin	Function	Pin	Function
1	V _I (+)	6	SENSE(-)
2	V _I (-)	7	V _O (-)
3	ON/OFF	8	V _O (-)
4	TRIM	9	V _O (+)
5	SENSE(+)	10	V _O (+)

Ordering Information

Please contact your Lineage Power Account Manager or Field Application Engineer for pricing and availability.

Input Voltage	Output Voltage	Output Power	Remote On/Off Logic*	Device Code	Comcode
48 V	3.3 V	66 W	Negative	HW100F1	107794257
48 V	5 V	100 W	Negative	HW100A1	107794240
48 V	3.3 V	66 W	Positive	HW100F	108015264
48 V	5 V	100 W	Positive	HW100A	108027350

* For an explanation of remote on/off, see the Feature Descriptions section.



LINEAGE POWER

World Wide Headquarters

Lineage Power Corporation

3000 Skyline Drive, Mesquite, TX 75149, USA

+1-800-526-7819

(Outside U.S.A.: **+1-972-284-2626**)

www.lineagepower.com

e-mail: techsupport1@lineagepower.com

Asia-Pacific Headquarters

Tel: +65 6416 4283

Europe, Middle-East and Africa Headquarters

Tel: +49 89 6089 286

India Headquarters

Tel: +91 80 28411633

Lineage Power reserves the right to make changes to the product(s) or information contained herein without notice. No liability is assumed as a result of their use or application. No rights under any patent accompany the sale of any such product(s) or information.

© 2008 Lineage Power Corporation, (Mesquite, Texas) All International Rights Reserved.