



Chipsmall Limited consists of a professional team with an average of over 10 year of expertise in the distribution of electronic components. Based in Hongkong, we have already established firm and mutual-benefit business relationships with customers from,Europe,America and south Asia,supplying obsolete and hard-to-find components to meet their specific needs.

With the principle of “Quality Parts,Customers Priority,Honest Operation,and Considerate Service”,our business mainly focus on the distribution of electronic components. Line cards we deal with include Microchip,ALPS,ROHM,Xilinx,Pulse,ON,Everlight and Freescale. Main products comprise IC,Modules,Potentiometer,IC Socket,Relay,Connector.Our parts cover such applications as commercial,industrial, and automotives areas.

We are looking forward to setting up business relationship with you and hope to provide you with the best service and solution. Let us make a better world for our industry!



Contact us

Tel: +86-755-8981 8866 Fax: +86-755-8427 6832

Email & Skype: info@chipsmall.com Web: www.chipsmall.com

Address: A1208, Overseas Decoration Building, #122 Zhenhua RD., Futian, Shenzhen, China



Surface Mount WLAN / Bluetooth Chip Antenna (2450MHz)

AMCA31-2R450G-S1F-T



RoHS / RoHS II Compliant

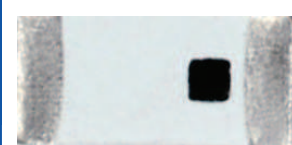

3.2 x 1.6 x 1.2mm

Moisture Sensitivity Level (MSL) – MSL = 1

FEATURES:

- 2450MHz, Bandwidth ≥ 90 MHz
- Suitable for RoHS compliant reflow
- Gain 0.5dBi (Peak) / -1dBi (Average)
- VSWR $< 2:1$
- Small size – 3.2 x 1.6 x 1.2mm (0.125 x 0.62 x 0.047 inch)
- Non Ground Mounting type.
- Power Handling 3W Max
- Matched to 50 Ohm.

APPLICATIONS:

- Wireless application - Bluetooth / WiFi (2.445GHz)
- High density applications
- Bluetooth headsets or ear pieces
- Computer mouse and keyboards
- PROFINET – Industrial automation
- Video Game systems
- Alternative to larger PCB solution

STANDARD SPECIFICATIONS

Maximum Ratings

Item	Value
Operating Temperature Range	-40°C to + 85°C
Storage Temperature Range	-10°C ~ +40 and RH °C 70% (Max.)

Electrical Characteristics

Item	Spec
Frequency	2450MHz
Bandwidth	≥ 90 MHz
Peak Gain	0.5 dBi typ.
Average Gain	-1 dBi typ
VSWR	$< 2:1$
Impedance	50 Ohm
Power Capability	3W max

PART IDENTIFICATION:

AMCA31-2R450G-S1F-T3

↓
Packaging

Blank: Bulk or Cut Tape

T3 : T/R 3000pcs per reel

Surface Mount WLAN / Bluetooth Chip Antenna (2450MHz)

AMCA31-2R450G-S1F-T

 RoHS / RoHS II Compliant

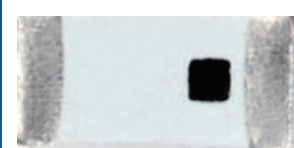

3.2 x 1.6 x 1.2mm

OUTLINE DIMENSIONS:

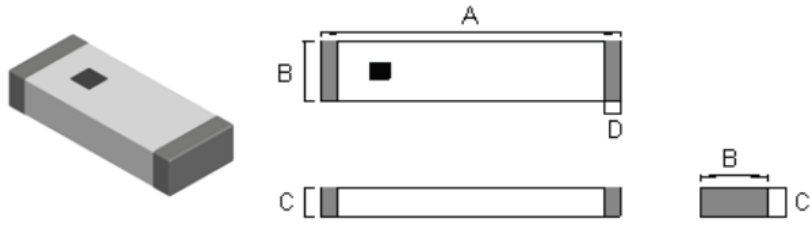

Recommended Land Pattern

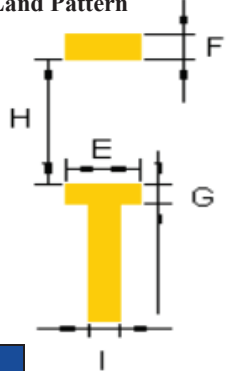

Series	A	B	C	D	E	F	G	H	I
AMCA31	3.2±0.2	1.6±0.2	1.2±0.2	0.5±0.2	1.6±0.2	0.8±0.2	0.8±0.2	2.6±0.2	3.5±0.2

(Dimensions: mm)

REFLOW PROFILE:

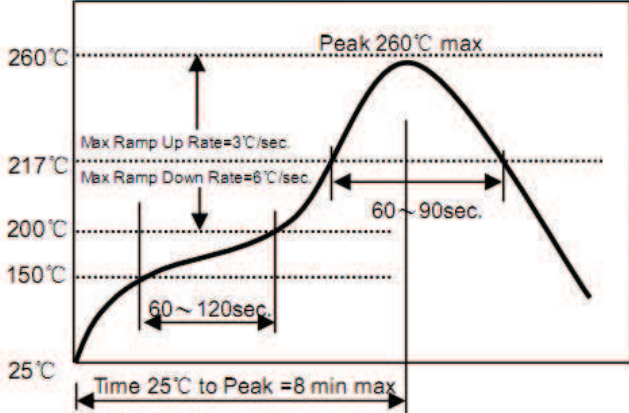

- Preheat condition: 150 ~200 /60~120°C sec.
- Allowed time above 217°C: 60~90sec.
- Max temp: 260°C
- Max time at max temp: 10sec.
- Solder paste: Sn/3.0Ag/0.5Cu
- Allowed Reflow time: 2x max

[Note: The reflow profile in the above table is only for qualification and is not meant to specify board assembly profiles. Actual board assembly profiles must be based on the customer's specific board design, solder paste and process, and should not exceed the parameters as the Reflow profile shows.]

MANUAL SOLDERING

Pre-heating Temperature: 120°C, 60°C ~ 300 sec.

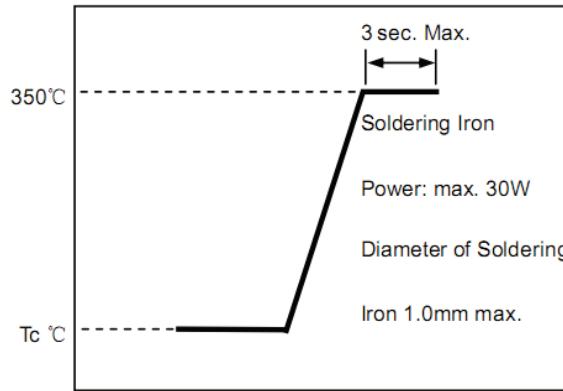

- Iron soldering power: Max.30W.
- Pre-heating: 150 / 60 sec. °C.
- Soldering Tip temperature: 350 Max. °C.
- Soldering time: 3 sec Max.
- Solder paste: Sn/3.0Ag/0.5Cu.
- Max 1 times for iron soldering.
- Soldering Temperature: 340°C±5°C, 5sec max per each terminal.

[Note: Take care not to apply the tip of the soldering iron to the terminal electrodes.]

Surface Mount WLAN / Bluetooth Chip Antenna (2450MHz)

AMCA31-2R450G-S1F-T

 RoHS / RoHS II Compliant

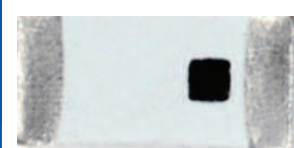

3.2 x 1.6 x 1.2mm

TAPE & REEL:

Packaging: 3000 Units per reel

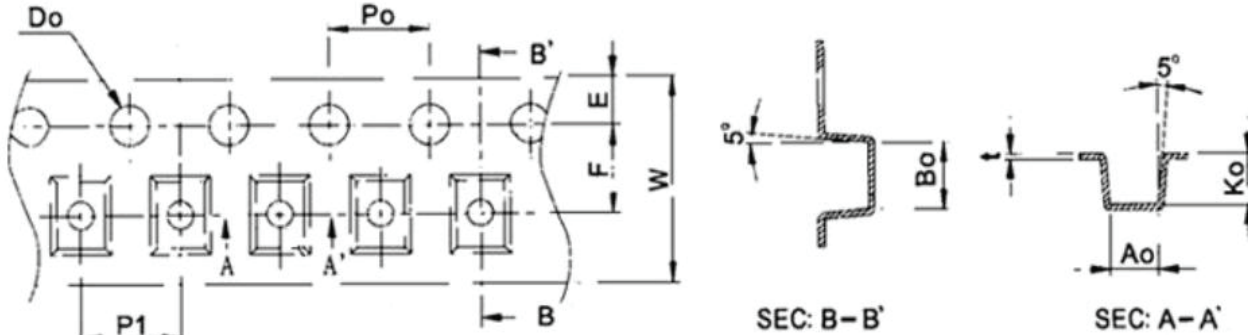

W	8.0±0.10	D0	1.50 +0.10 / -0.0
P1	4.0±0.10	P0	4.0±0.10
E	1.75±0.10	K0	1.50±0.10
F	3.50±0.15	A0	1.80±0.10
B0	3.50±0.10	t	0.22±0.10

Reel Dimensions

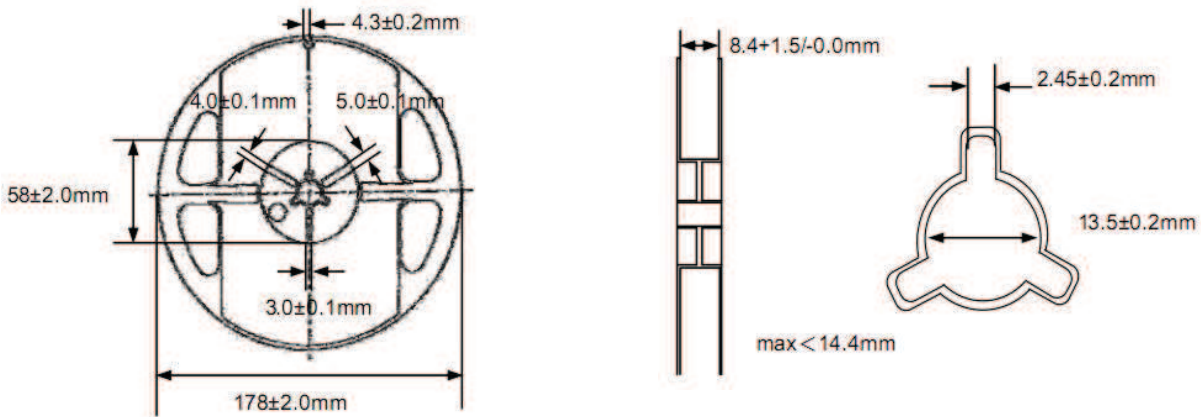

Mounting Direction of Tape on Reel

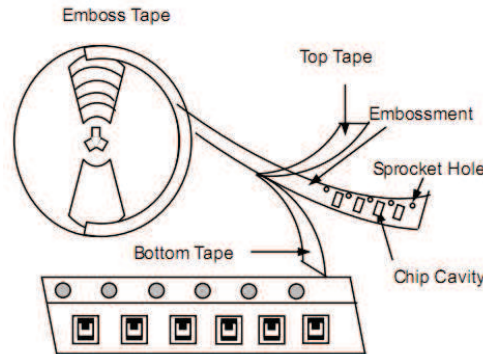

Note: The sprocket holes are to the right as the tape is pulled toward the user.

(Dimensions: mm)

ATTENTION: Abracon Corporation's products are COTS – Commercial-Off-The-Shelf products; suitable for Commercial, Industrial and, where designated, Automotive Applications. Abracon's products are not specifically designed for Military, Aviation, Aerospace, Life-dependant Medical applications or any application requiring high reliability where component failure could result in loss of life and/or property. For applications requiring high reliability and/or presenting an extreme operating environment, written consent and authorization from Abracon Corporation is required. Please contact Abracon Corporation for more information.