



Chipsmall Limited consists of a professional team with an average of over 10 year of expertise in the distribution of electronic components. Based in Hongkong, we have already established firm and mutual-benefit business relationships with customers from,Europe,America and south Asia,supplying obsolete and hard-to-find components to meet their specific needs.

With the principle of “Quality Parts,Customers Priority,Honest Operation,and Considerate Service”,our business mainly focus on the distribution of electronic components. Line cards we deal with include Microchip,ALPS,ROHM,Xilinx,Pulse,ON,Everlight and Freescale. Main products comprise IC,Modules,Potentiometer,IC Socket,Relay,Connector.Our parts cover such applications as commercial,industrial, and automotives areas.

We are looking forward to setting up business relationship with you and hope to provide you with the best service and solution. Let us make a better world for our industry!



Contact us

Tel: +86-755-8981 8866 Fax: +86-755-8427 6832

Email & Skype: info@chipsmall.com Web: www.chipsmall.com

Address: A1208, Overseas Decoration Building, #122 Zhenhua RD., Futian, Shenzhen, China



Data Sheet

Description

The AMMC-5025 MMIC is a 30KHz to 80GHz ultra broadband traveling wave amplifier. In this operational frequency band, AMMC-5025 provides 8dB gain with better than 10dB input and output return losses. This performance is suitable for instrumentation and high speed digital communications.

Component Image

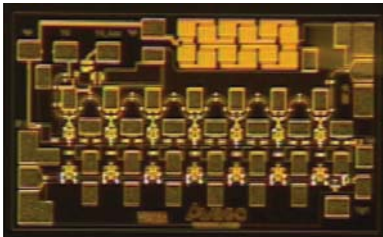

Chip Size: 1600 x 950 μm (63 x 37 mils)

Chip Size Tolerance: $\pm 10 \mu\text{m}$ (± 0.4 mils)

Chip Thickness: 100 $\pm 10 \mu\text{m}$ (4 ± 0.4 mils)

Pad Dimensions: 75 x 75 μm (3 x 3 ± 0.4 mils)

Features

- 50 Ω match on input and output
- ESD protection, 70V MM and 300V HBM

Typical Performance (Vd=5V, Idsq=0.1A)

- Frequency range 30KHz to 80 GHz
- Small signal Gain: 8dB
- P-1dB: 15 dBm @ 40 GHz
- Input/Output return loss of -10dB/-10dB

Applications

- Microwave Radio systems
- Satellite VSAT, Up/Down Link
- Optical fiber laser driver

Note:

1. This MMIC uses depletion mode pHEMT devices. Negative supply is used for DC gate biasing.



Attention: Observe Precautions for handling electrostatic sensitive devices.

ESD Machine Model (Class A): 70V

ESD Human Body Model (Class 1A): 300V

Refer to Avago Application Note A004R:

Electrostatic Discharge Damage and Control.

Absolute Maximum Ratings^[1,2,3, and 4]

Symbol	Parameters	Unit	Max
V _d	Positive Supply Voltage ^[2]	V	7
V _{g1}	Gate Supply Voltage	V	-3.6 to 0
V _{g2}	Gate Supply Voltage	V	-2.5 to +2.5
P _D	Power Dissipation ^[2]	W	0.8
P _{in}	CW Input Power	dBm	23
T _{ch}	Operating Channel Temp.	°C	+150
T _{stg}	Storage Case Temp.	°C	-65 to +155
T _{max}	Maximum Assembly Temp (30 sec max)	°C	+320

Notes:

1. Operation in excess of any one of these conditions may result in permanent damage to this device.
2. Combinations of supply voltage and drain current shall not exceed P_D.
3. The operating channel temperature will directly affect the device MTTF. For maximum life, it is recommended that junction temperatures be maintained at the lowest possible levels.

DC Specifications/ Physical Properties^[5]

Symbol	Parameters and Test Conditions	Unit	Min	Typ	Max
V _d	Drain Supply Voltage	V		5	
I _{d(q)}	Drain Supply Current (V _d =5 V, V _g set for I _{d(q)} Typical)	mA		100	
V _{g1}	Gate Supply Operating Voltage (I _{d(q)} = 100 mA)	V	-3.6	-2.0	-1.2
V _{g2}	Gain control voltage. Open on the V _{g2} makes highest gain.	V	-2.5	+1.2	+2.5
R _{θjc}	Thermal Resistance ^[5] (Channel-to-Backside)	°C/W		12.8	
T _{ch}	Channel Temperature @85°C Backside	°C		91.4	

RF Specifications^[1,2]

T_A = 25°C, V_{dd} = 5 V, I_{dq} = 0.1 A, Z_o = 50 Ω

Symbol	Parameters and Test Conditions	Units	Minimum	Typical	Maximum
Freq	Operational Frequency	GHz	30KHz		80
Gain	Small-signal Gain Freq = 2, 10, 20, 30, 40 GHz	dB	7.5	8	
P _{-1dB}	Output Power at 1dB Gain Compression Freq = 40GHz	dBm	13	15	
OIP3	Third Order Output Intercept Point@20GHz Δf = 10MHz, Po = +10dBm, SCL	dBm		20	
RL _{in}	Input Return Loss	dB		10	
RL _{out}	Output Return Loss	dB		15	
Isolation	Reverse Isolation	dB		27	

Notes:

1. Small/Large -signal data measured from an on-wafer tester at T_A = 25°C.
2. 100% on-wafer RF test of Gain, Return Losses and Reverse Isolation is done at frequencies: 2, 10, 20, 30, and 40 GHz.

Typical Performance (Data obtained from on-wafer condition)

($T_A = 25^\circ\text{C}$, $V_{dd} = 5\text{V}$, $I_{dq} = 0.1\text{A}$, $V_g = -1.8\text{V}$, $Z_{in} = Z_{out} = 50\ \Omega$)

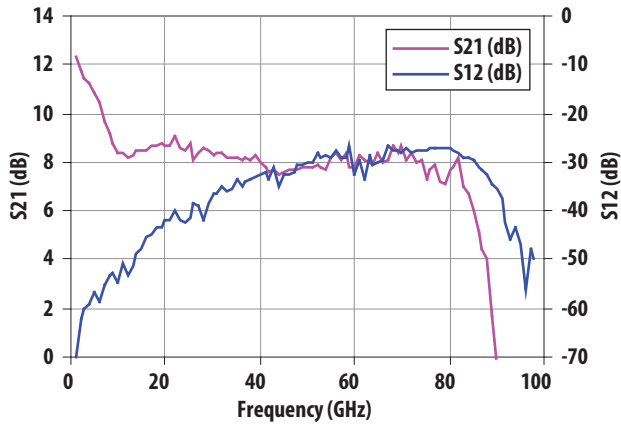

Figure 1. Typical Gain and Reverse Isolation

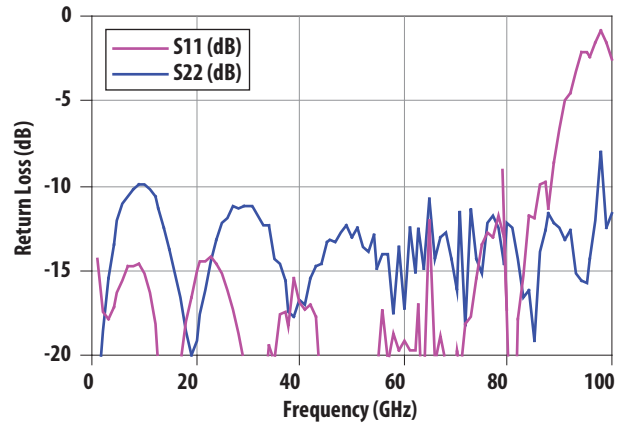

Figure 2. Typical Return Loss (Input and Output)

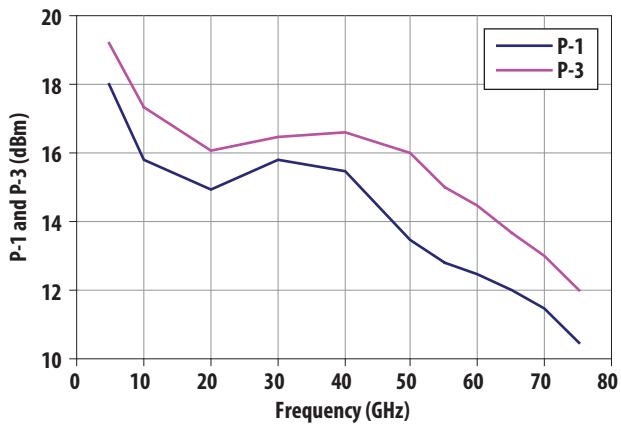

Figure 3. Typical Output Power vs. Frequency

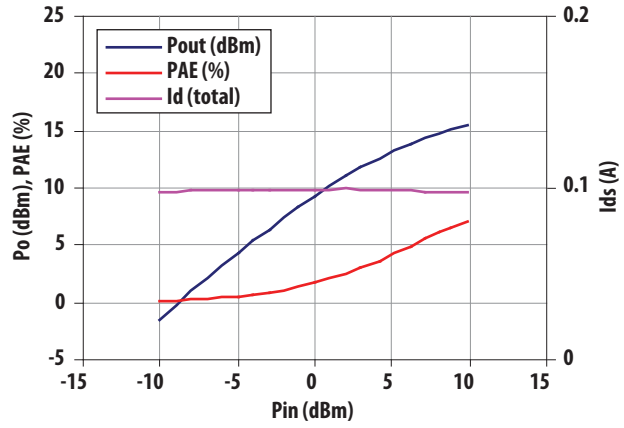

Figure 4. Typical Output Power, PAE, and Total Drain Current versus Input Power at 50GHz

Typical Bias Dependency (Data obtained from on-wafer condition)

($T_A = 25^\circ\text{C}$, $V_{dd} = 5\text{V}$, $Z_{in} = Z_{out} = 50\ \Omega$)

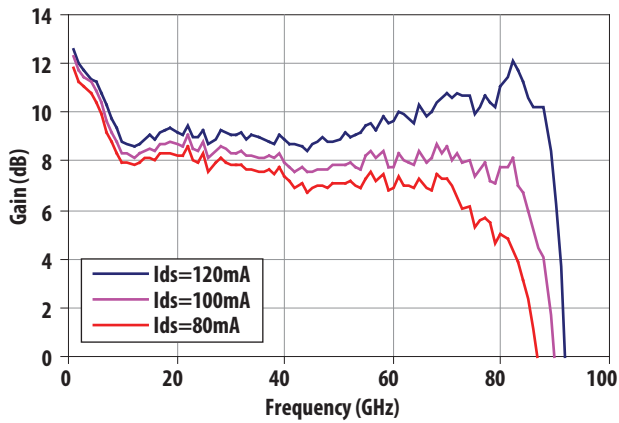

Figure 5. Typical Gain bias dependency at $V_{ds}=5\text{V}$

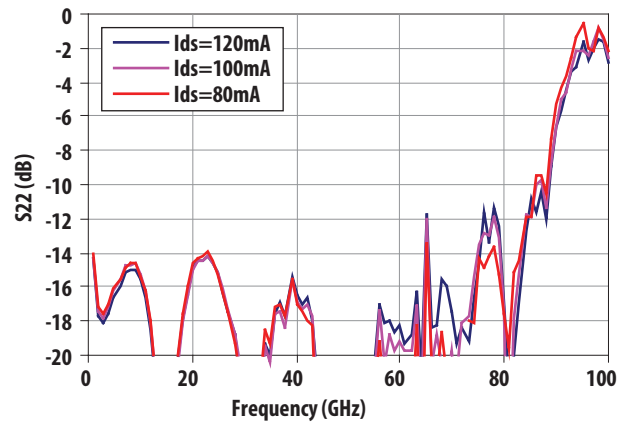

Figure 6. Typical S_{22} bias dependency at $V_{ds}=5\text{V}$

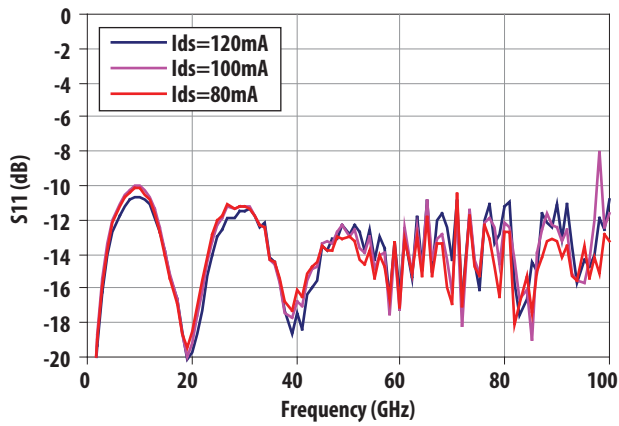

Figure 7. Typical S_{11} bias dependency at $V_{ds}=5\text{V}$

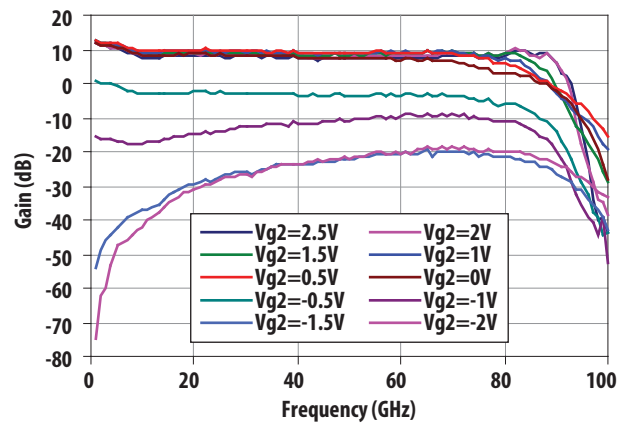
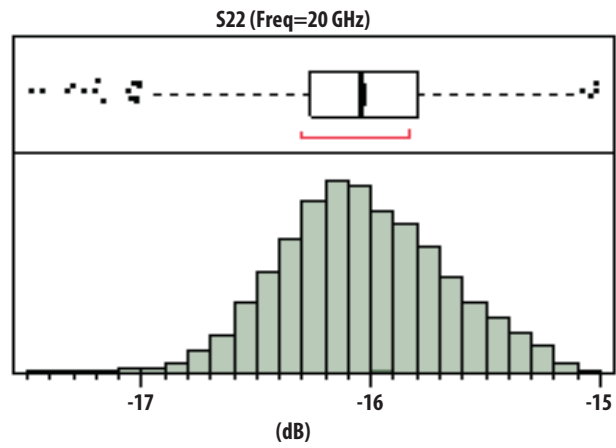
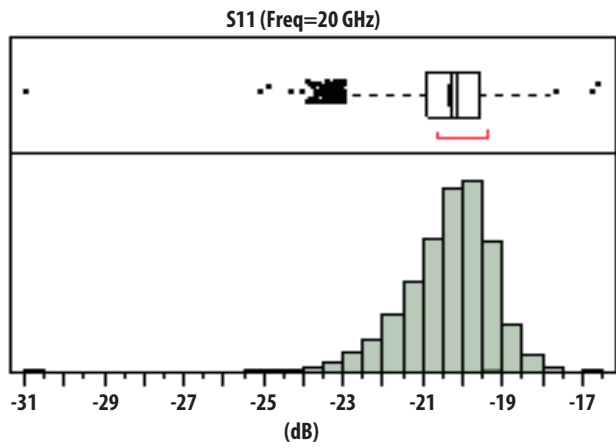
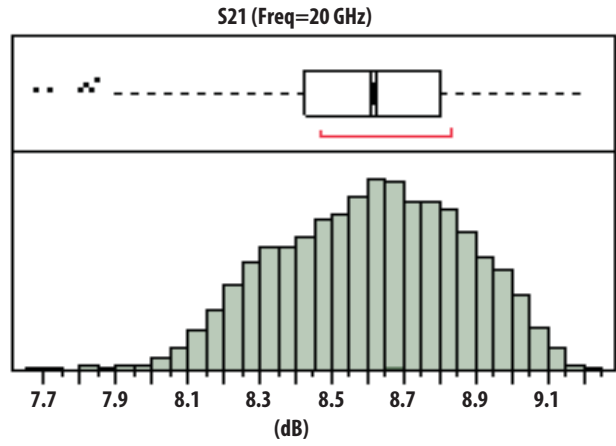
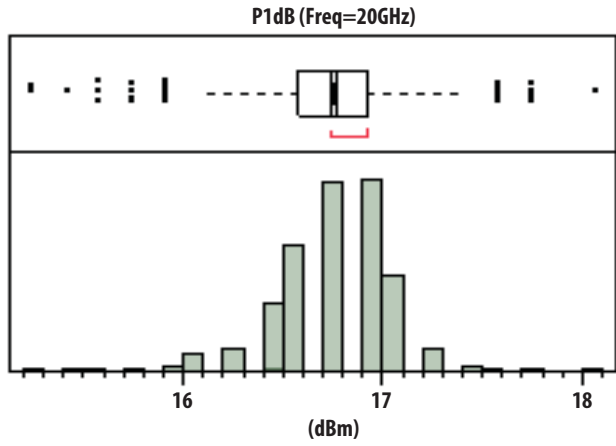

Figure 8. Gain control using V_{g2} voltage at $V_{ds}=5\text{V}$

AMMC-5025 Performance Distributions Sample Size= 6,876



Typical Scattering Parameters [1], ($T_A = 25^\circ\text{C}$, $V_d = 5\text{ V}$, $I_D = 0.1\text{ A}$, $Z_{in} = Z_{out} = 50\ \Omega$)

Freq [GHz]	S11			S21			S12			S22		
	dB	Mag	Phase	dB	Mag	Phase	dB	Mag	Phase	dB	Mag	Phase
1	-23.99	0.06	-73.62	12.31	4.12	145.45	-69.87	3.21E-04	-56.06	-14.28	0.19	-96.92
2	-18.65	0.12	-94.96	11.73	3.86	125.95	-62.19	7.77E-04	42.58	-17.44	0.13	-116.92
3	-15.45	0.17	-108.86	11.44	3.73	103.10	-60.07	9.92E-04	16.73	-17.83	0.13	-125.57
4	-13.42	0.21	-119.17	11.21	3.64	80.66	-59.29	1.09E-03	13.76	-17.20	0.14	-130.80
5	-12.03	0.25	-129.52	10.89	3.50	56.99	-56.48	1.50E-03	9.53	-16.28	0.15	-137.14
6	-11.11	0.28	-139.24	10.41	3.31	35.49	-58.61	1.17E-03	-9.71	-15.61	0.17	-145.25
7	-10.58	0.30	-148.77	9.69	3.05	14.16	-55.23	1.73E-03	-35.56	-14.78	0.18	-152.92
8	-10.23	0.31	-156.02	9.22	2.89	-6.61	-53.10	2.21E-03	-56.51	-14.69	0.18	-160.55
9	-10.00	0.32	-164.67	8.76	2.74	-28.44	-52.66	2.33E-03	-87.14	-14.65	0.19	-170.92
10	-9.98	0.32	-171.35	8.34	2.61	-48.35	-54.79	1.82E-03	-98.55	-15.23	0.17	178.16
11	-10.27	0.31	-177.66	8.34	2.61	-68.27	-50.71	2.91E-03	-101.79	-16.28	0.15	168.15
12	-10.64	0.29	176.54	8.16	2.56	-89.02	-53.25	2.17E-03	-116.45	-18.10	0.12	161.44
13	-11.41	0.27	171.28	8.29	2.60	-107.30	-51.39	2.69E-03	-130.97	-21.07	0.09	154.55
14	-12.43	0.24	166.56	8.44	2.64	-126.33	-49.01	3.54E-03	-138.45	-24.75	0.06	158.47
15	-13.75	0.21	163.42	8.47	2.65	-145.14	-47.72	4.11E-03	-158.18	-29.78	0.03	-153.13
16	-15.13	0.18	159.33	8.44	2.64	-166.53	-45.17	5.51E-03	175.62	-25.88	0.05	-123.66
17	-16.59	0.15	162.90	8.69	2.72	171.17	-44.82	5.74E-03	155.52	-20.77	0.09	-117.97
18	-18.59	0.12	171.69	8.71	2.73	150.24	-43.32	6.82E-03	135.56	-17.99	0.13	-120.53
19	-19.95	0.10	-173.49	8.76	2.74	128.84	-43.20	6.92E-03	111.61	-16.53	0.15	-125.92
20	-19.18	0.11	-154.71	8.68	2.72	106.41	-42.05	7.90E-03	89.64	-15.05	0.18	-134.47
21	-17.62	0.13	-142.23	8.65	2.71	85.73	-42.14	7.81E-03	74.32	-14.45	0.19	-142.80
22	-16.19	0.16	-138.96	9.07	2.84	64.35	-40.01	9.99E-03	57.07	-14.44	0.19	-151.66
23	-14.50	0.19	-140.00	8.53	2.67	40.98	-41.72	8.20E-03	30.87	-14.17	0.20	-159.25
24	-13.26	0.22	-141.73	8.44	2.64	19.92	-42.21	7.75E-03	10.66	-14.57	0.19	-163.44
25	-12.24	0.24	-143.90	8.82	2.76	-1.95	-41.31	8.60E-03	-12.92	-15.12	0.18	-170.40
26	-11.92	0.25	-149.24	8.11	2.54	-24.68	-38.31	1.21E-02	-33.09	-16.15	0.16	-177.73
27	-11.27	0.27	-153.35	8.41	2.63	-46.27	-39.03	1.12E-02	-49.00	-17.25	0.14	-177.36
28	-11.34	0.27	-158.37	8.60	2.69	-65.32	-41.74	8.18E-03	-51.65	-18.78	0.12	174.70
29	-11.23	0.27	-162.71	8.47	2.65	-86.91	-38.69	1.16E-02	-67.54	-20.71	0.09	178.70
30	-11.19	0.28	-168.87	8.31	2.60	-108.37	-36.72	1.46E-02	-98.62	-21.14	0.09	-178.81
31	-11.17	0.28	-171.85	8.36	2.62	-131.62	-36.29	1.53E-02	-116.44	-21.06	0.09	-173.56
32	-11.71	0.26	-178.55	8.38	2.62	-153.01	-34.84	1.81E-02	-144.42	-21.44	0.08	-167.22
33	-12.31	0.24	177.15	8.23	2.58	-174.09	-35.81	1.62E-02	-169.49	-23.56	0.07	-164.19
34	-12.39	0.24	178.75	8.21	2.57	164.71	-35.30	1.72E-02	162.06	-19.46	0.11	-143.08
35	-14.33	0.19	178.41	8.15	2.56	142.95	-33.65	2.08E-02	153.31	-20.37	0.10	-135.61
36	-14.63	0.19	174.11	8.13	2.55	120.78	-35.22	1.73E-02	134.39	-17.53	0.13	-144.76
37	-15.66	0.16	179.07	8.20	2.57	99.36	-33.96	2.01E-02	110.88	-17.39	0.13	-144.66
38	-17.38	0.14	-172.55	8.09	2.54	79.99	-33.63	2.08E-02	86.39	-18.34	0.12	-143.70
39	-17.73	0.13	175.32	8.33	2.61	56.48	-32.90	2.26E-02	75.36	-15.50	0.17	-168.59
40	-16.72	0.15	-162.20	7.98	2.51	35.53	-32.53	2.36E-02	44.17	-16.92	0.14	-160.05
41	-17.01	0.14	-159.26	7.77	2.45	14.46	-31.99	2.52E-02	28.89	-17.35	0.14	-174.76

Typical Scattering Parameters [1], (Continued)

Freq [GHz]	S11			S21			S12			S22		
	dB	Mag	Phase	dB	Mag	Phase	dB	Mag	Phase	dB	Mag	Phase
42	-15.50	0.17	-158.31	7.61	2.40	-8.30	-33.42	2.13E-02	-0.50	-16.97	0.14	179.67
43	-14.80	0.18	-153.02	7.73	2.44	-34.27	-31.12	2.78E-02	-20.36	-17.73	0.13	-175.55
44	-14.68	0.18	-140.97	7.52	2.38	-53.64	-34.84	1.81E-02	8.78	-22.75	0.07	146.52
45	-13.31	0.22	-154.87	7.61	2.40	-74.69	-32.76	2.30E-02	-15.11	-20.52	0.09	171.71
46	-13.20	0.22	-149.60	7.70	2.43	-97.71	-32.73	2.31E-02	-55.67	-22.30	0.08	140.76
47	-13.40	0.21	-157.37	7.67	2.42	-119.57	-32.12	2.48E-02	-93.36	-25.95	0.05	169.29
48	-12.76	0.23	-164.27	7.69	2.42	-141.65	-30.78	2.89E-02	-99.61	-24.46	0.06	147.05
49	-12.35	0.24	-165.03	7.82	2.46	-164.67	-30.54	2.97E-02	-131.38	-34.20	0.02	159.74
50	-12.98	0.22	-178.67	7.81	2.46	172.08	-29.89	3.20E-02	-156.76	-25.26	0.05	175.77
51	-12.51	0.24	-173.74	7.83	2.46	149.86	-30.18	3.10E-02	-178.78	-33.52	0.02	-130.51
52	-13.61	0.21	-172.01	7.93	2.49	128.77	-28.27	3.86E-02	171.08	-31.57	0.03	-115.78
53	-13.92	0.20	177.60	7.77	2.45	105.87	-29.13	3.50E-02	136.16	-23.15	0.07	-132.42
54	-12.94	0.23	-179.13	7.71	2.43	80.50	-28.55	3.74E-02	109.76	-21.67	0.08	-114.64
55	-14.85	0.18	-177.74	8.22	2.58	58.11	-28.87	3.60E-02	93.24	-21.71	0.08	-147.76
56	-14.00	0.20	-172.76	8.41	2.63	37.15	-27.83	4.06E-02	73.29	-17.35	0.14	-132.07
57	-13.98	0.20	-174.58	8.12	2.55	13.47	-28.94	3.57E-02	40.39	-20.62	0.09	-128.62
58	-17.56	0.13	-164.98	8.39	2.63	-6.90	-28.90	3.59E-02	29.47	-18.73	0.12	168.41
59	-13.68	0.21	178.77	7.77	2.45	-31.83	-26.85	4.54E-02	7.31	-19.77	0.10	170.62
60	-17.29	0.14	-162.12	7.79	2.45	-54.89	-32.45	2.38E-02	-9.89	-19.16	0.11	139.41
61	-12.46	0.24	-178.85	8.33	2.61	-80.24	-29.70	3.27E-02	-42.64	-19.72	0.10	134.43
62	-15.19	0.17	-173.34	8.05	2.53	-103.95	-33.29	2.17E-02	-71.74	-19.74	0.10	89.74
63	-12.41	0.24	-161.80	7.96	2.50	-130.10	-28.76	3.65E-02	-71.24	-16.99	0.14	61.67
64	-14.96	0.18	162.01	7.90	2.48	-152.97	-30.55	2.97E-02	-92.14	-24.01	0.06	75.15
65	-10.79	0.29	-154.54	8.43	2.64	-177.52	-29.94	3.19E-02	-126.69	-12.03	0.25	32.27
66	-14.34	0.19	158.99	7.94	2.49	159.47	-29.50	3.35E-02	-150.30	-20.43	0.10	76.21
67	-13.08	0.22	-134.82	8.11	2.54	131.55	-26.52	4.72E-02	177.09	-18.80	0.11	-51.51
68	-12.81	0.23	-173.73	8.69	2.72	107.29	-27.56	4.19E-02	158.17	-20.56	0.09	-43.17
69	-14.26	0.19	172.94	8.37	2.62	83.04	-27.65	4.15E-02	123.32	-24.54	0.06	-140.20
70	-16.20	0.15	-173.41	8.64	2.70	58.43	-28.20	3.89E-02	104.25	-19.68	0.10	-124.67
71	-11.56	0.26	-171.73	8.08	2.54	26.64	-26.98	4.48E-02	86.83	-21.32	0.09	178.78
72	-18.26	0.12	126.51	8.35	2.62	2.92	-28.07	3.95E-02	62.28	-18.15	0.12	136.89
73	-11.30	0.27	172.49	7.98	2.51	-24.03	-27.77	4.09E-02	36.07	-17.75	0.13	96.33
74	-14.30	0.19	-169.17	8.07	2.53	-51.96	-27.62	4.16E-02	17.47	-15.45	0.17	58.31
75	-15.13	0.18	160.81	7.34	2.33	-80.22	-27.46	4.24E-02	-7.47	-13.49	0.21	23.56
76	-12.17	0.25	170.35	7.64	2.41	-108.51	-27.29	4.32E-02	-31.56	-12.78	0.23	20.08
77	-11.84	0.26	-175.68	7.92	2.49	-137.63	-27.16	4.39E-02	-55.43	-12.98	0.22	8.02
78	-12.45	0.24	164.14	7.22	2.30	-166.12	-27.09	4.42E-02	-72.41	-11.83	0.26	-20.15
79	-14.60	0.19	157.52	7.11	2.27	165.62	-26.96	4.49E-02	-99.83	-13.06	0.22	-30.35
80	-12.21	0.25	147.32	7.73	2.43	133.90	-27.24	4.34E-02	-124.77	-17.30	0.14	-25.89
81	-12.46	0.24	159.37	7.77	2.45	106.11	-27.48	4.23E-02	-155.86	-28.28	0.04	-30.33
82	-14.32	0.19	161.28	8.14	2.55	74.42	-28.06	3.96E-02	173.77	-17.84	0.13	60.41

Typical Scattering Parameters [1], (Continued)

Freq [GHz]	S11			S21			S12			S22		
	dB	Mag	Phase	dB	Mag	Phase	dB	Mag	Phase	dB	Mag	Phase
83	-16.64	0.15	152.72	6.96	2.23	43.86	-28.93	3.58E-02	143.86	-15.28	0.17	36.42
84	-16.13	0.16	144.48	6.75	2.18	11.94	-28.86	3.61E-02	114.26	-11.71	0.26	20.29
85	-19.10	0.11	166.48	5.98	1.99	-15.86	-29.68	3.28E-02	76.14	-11.91	0.25	11.38
86	-13.97	0.20	134.55	5.16	1.81	-48.54	-31.27	2.73E-02	49.12	-9.97	0.32	-0.26
87	-12.56	0.24	135.11	4.43	1.67	-79.68	-31.35	2.71E-02	10.38	-9.78	0.32	-6.24
88	-11.57	0.26	131.84	4.03	1.59	-115.31	-32.51	2.37E-02	-19.05	-11.31	0.27	-1.38
89	-12.25	0.24	120.86	1.67	1.21	-149.46	-34.59	1.86E-02	-63.31	-8.64	0.37	-2.01
90	-12.49	0.24	126.24	-0.80	0.91	168.79	-35.60	1.66E-02	-93.76	-6.63	0.47	0.98
91	-13.24	0.22	111.67	-3.93	0.64	139.06	-37.67	1.31E-02	-137.97	-4.99	0.56	-3.49
92	-12.60	0.23	116.82	-7.69	0.41	99.48	-42.20	7.76E-03	-120.24	-4.60	0.59	-7.41
93	-15.19	0.17	115.46	-12.24	0.24	70.72	-45.98	5.03E-03	-167.53	-3.23	0.69	-14.77
94	-15.57	0.17	98.36	-15.43	0.17	40.10	-43.49	6.69E-03	148.42	-2.13	0.78	-17.32
95	-15.73	0.16	82.30	-18.17	0.12	15.26	-46.84	4.55E-03	137.70	-2.13	0.78	-29.11
96	-14.37	0.19	97.00	-21.79	0.08	-13.16	-55.96	1.59E-03	153.58	-2.46	0.75	-35.83
97	-12.01	0.25	81.38	-24.88	0.06	-34.33	-48.03	3.97E-03	110.84	-1.60	0.83	-40.19
98	-7.91	0.40	75.00	-27.42	0.04	-66.49	-49.87	3.21E-03	38.33	-0.85	0.91	-52.74
99	-12.46	0.24	65.38	-31.17	0.03	-91.90	-103.00	7.08E-06	92.96	-1.52	0.84	-55.74
100	-11.59	0.26	68.80	-34.78	0.02	-113.10	-71.50	2.66E-04	-26.59	-2.62	0.74	-41.36

Note:

1. Data obtained from an on-wafer condition.

Application and Usage

AMMC-5025 is biased with a single positive drain supply (V_{dd}), a negative gate supply (V_{g1}), and has a positive control gate supply (V_{g2}). For best overall performance, the recommended bias condition for the AMMC-5025 is $V_{dd} = 5\text{ V}$ and $I_{dd} = 100\text{ mA}$. To achieve this drain current level, V_{g1} is typically -1.8 V . Typically, DC current flow for V_{g1} is -10 mA . Open circuit is the default setting for V_{g2} when not utilizing gain control. Minor improvements in performance are possible depending on the application. The drain bias voltage range is 3 to 6V and the quiescent drain current biasing range is 80mA to 120mA.

Input and output RF ports are DC coupled; therefore, DC decoupling capacitors are required if there are DC paths. RF bond connections should be kept as short as possible to reduce RF lead inductance which will degrade performance above 20 GHz.

Ground connections are made with plated through-holes to the backside of the device; therefore, ground wires are not needed.

Using the simplest form of assembly (Figure 11), the device is capable of delivering flat gain over a 2-80 GHz range with a minimum of gain slope and ripple. Figure 11 shows a typical assembly application.

However, this device is designed with DC coupled RF I/O ports, and operation may be extended to lower frequencies (<2 GHz) through the use of off-chip low-frequency extension circuitry and proper external biasing components. With low frequency bias extension it may be used in a variety of time-domain applications (through 80 Gb/s).

Refer to the low frequency extension section of Avago Applications Note 5359 "AMMC-5024 30KHz-40GHz TWA Operational Guide" for detailed information on use below 2 GHz.

Note:

1. Eutectic attach is not recommended and may jeopardize reliability of the device.

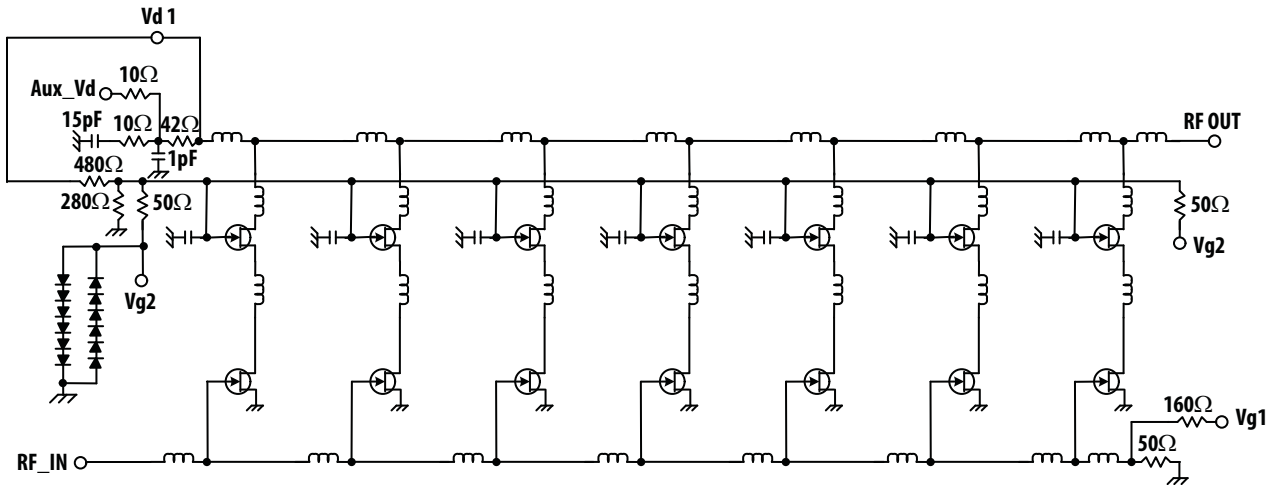

Figure 9. Simplified schematic for AMMC5025

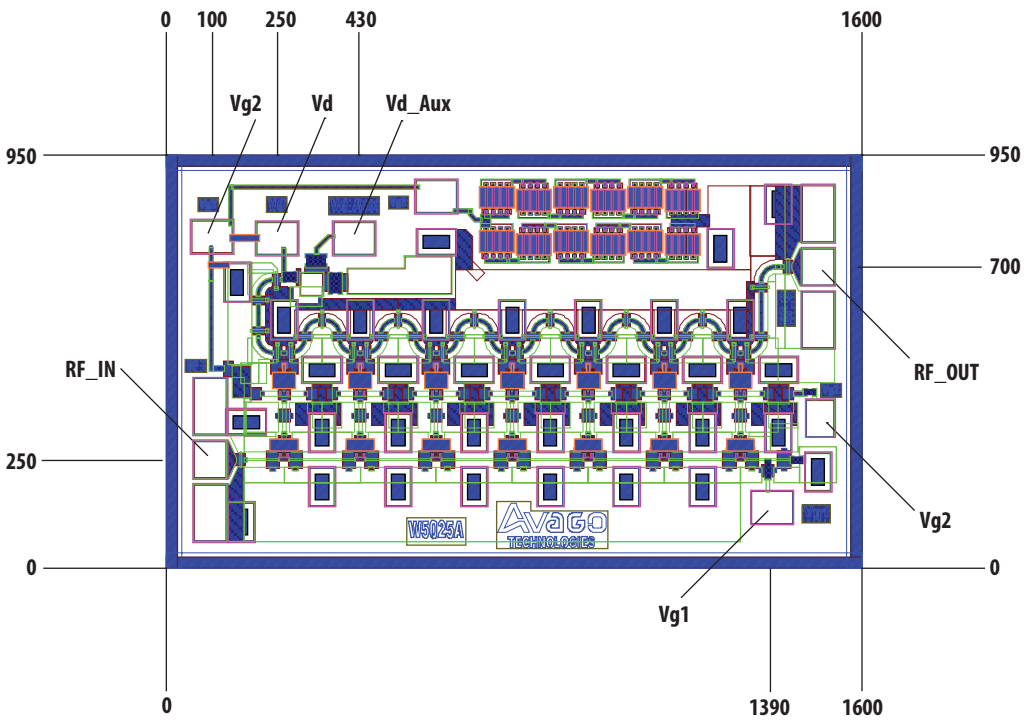

Figure 10. Bonding pad location

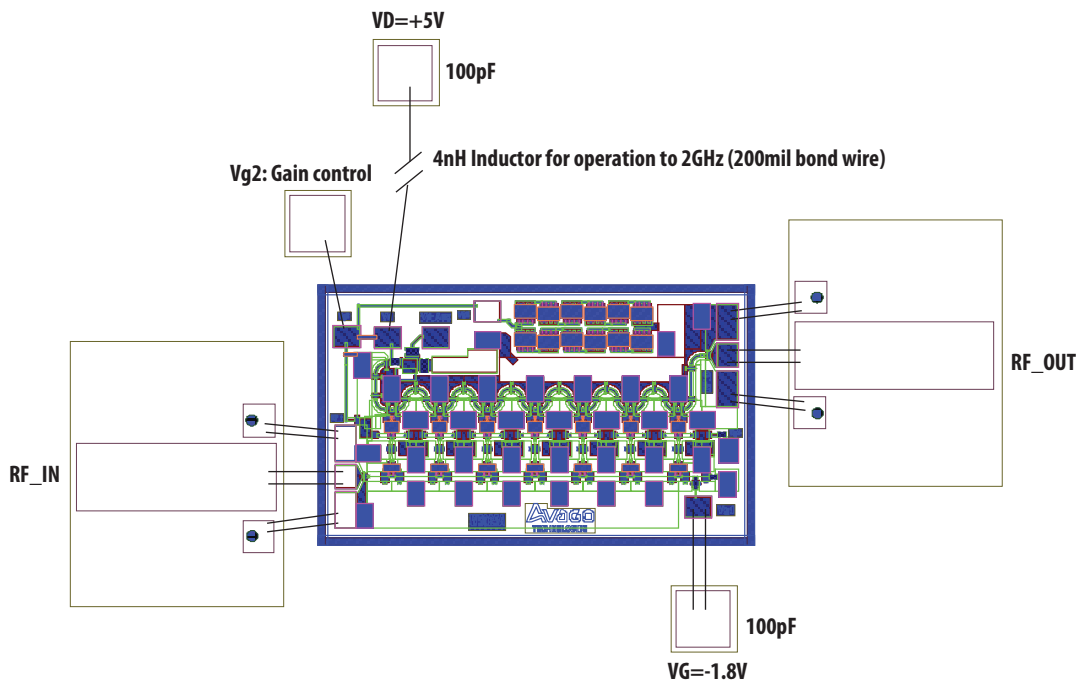

Figure 11. Recommended assemble example

Note: No RF performance degradation is seen due to ESD up to 300V HBM and 70V MM. The user is reminded that this device is ESD sensitive and needs to be handled with all necessary ESD protocols.



Names and Contents of the Toxic and Hazardous Substances or Elements in the Products
 产品中有毒有害物质或元素的名称及含量

Part Name 部件名称	Toxic and Hazardous Substances or Elements 有毒有害物质或元素					
	Lead (Pb) 铅 (Pb)	Mercury (Hg) 汞 (Hg)	Cadmium (Cd) 镉 (Cd)	Hexavalent (Cr(VI)) 六价铬 (Cr(VI))	Polybrominated biphenyl (PBB) 多溴联苯 (PBB)	Polybrominated diphenylether (PBDE) 多溴二苯醚 (PBDE)
100pF capacitor	x	o	o	o	o	o

o: indicates that the content of the toxic and hazardous substance in all the homogeneous materials of the part is below the concentration limit requirement as described in SJ/T 11363-2006.
 x: indicates that the content of the toxic and hazardous substance in at least one homogeneous material of the part exceeds the concentration limit requirement as described in SJ/T 11363-2006.
 (The enterprise may further explain the technical reasons for the "x" indicated portion in the table in accordance with the actual situations.)

o: 表示该有毒有害物质在该部件所有均质材料中的含量均在 SJ/T 11363-2006 标准规定的限量要求以下。
 x: 表示该有毒有害物质至少在该部件的某一均质材料中的含量超出 SJ/T 11363-2006 标准规定的限量要求。
 (企业可在此处, 根据实际情况对上表中打"x"的技术原因进行进一步说明。)

Note: EU RoHS compliant under exemption clause of "lead in electronic ceramic parts (e.g. piezoelectronic devices)"

For product information and a complete list of distributors, please go to our web site: www.avagotech.com

Avago, Avago Technologies, and the A logo are trademarks of Avago Technologies in the United States and other countries.
 Data subject to change. Copyright © 2005-2009 Avago Technologies. All rights reserved.
 AV02-2200EN - October 14, 2009

