



Chipsmall Limited consists of a professional team with an average of over 10 year of expertise in the distribution of electronic components. Based in Hongkong, we have already established firm and mutual-benefit business relationships with customers from,Europe,America and south Asia,supplying obsolete and hard-to-find components to meet their specific needs.

With the principle of “Quality Parts,Customers Priority,Honest Operation,and Considerate Service”,our business mainly focus on the distribution of electronic components. Line cards we deal with include Microchip,ALPS,ROHM,Xilinx,Pulse,ON,Everlight and Freescale. Main products comprise IC,Modules,Potentiometer,IC Socket,Relay,Connector.Our parts cover such applications as commercial,industrial, and automotives areas.

We are looking forward to setting up business relationship with you and hope to provide you with the best service and solution. Let us make a better world for our industry!



## Contact us

Tel: +86-755-8981 8866 Fax: +86-755-8427 6832

Email & Skype: info@chipsmall.com Web: www.chipsmall.com

Address: A1208, Overseas Decoration Building, #122 Zhenhua RD., Futian, Shenzhen, China



# AMMC-6140

## 20 – 40 GHz Output x2 Active Frequency Multiplier



### Data Sheet

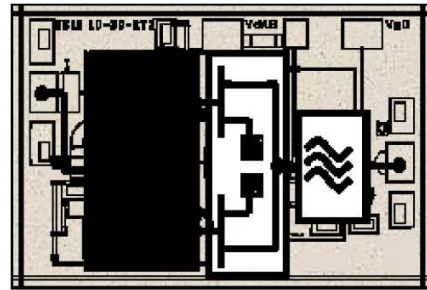

Chip Size:	1300 x 900 $\mu\text{m}$ (51 x 35 mils)
Chip Size Tolerance:	$\pm 10 \mu\text{m}$ ( $\pm 0.4$ mils)
Chip Thickness:	100 $\pm 10 \mu\text{m}$ (4 $\pm 0.4$ mils)
Pad Dimensions:	120 x 80 $\mu\text{m}$ (5x3 $\pm 0.4$ mils)

### Description

Avago's AMMC-6140 is an easy-to-use x2 active frequency multiplier MMIC designed for commercial communication systems. The MMIC takes a 10 to 20 GHz input signal and doubles it to 20 to 40 GHz. It could also be used between 9–10 GHz and 20–22 GHz with slight degradation in Conversion Loss or Fundamental Suppression. It has an integrated matching, harmonic suppression, and bias network. The input/output are matched to 50 $\Omega$  and fully DC blocked. The MMIC is fabricated using PHEMT technology. The backside of this die is both RF and DC ground. This helps simplify the assembly process and reduces assembly-related performance variations and costs. For improved reliability and moisture protection, the die is passivated at the active areas. This MMIC is a cost effective alternative to bulky hybrid FET and diode doublers that require high input drive levels, have high conversion loss and poor fundamental suppression.

### Absolute Maximum Ratings<sup>[1]</sup>

Symbol	Parameters/Conditions	Units	Min.	Max.
V <sub>d</sub>	Positive Drain Voltage	V		7
V <sub>g</sub>	Gate Supply Voltage	V	-3.0	0.5
I <sub>d</sub>	Drain Current	mA		-3
P <sub>in</sub>	CW Input Power	dBm		15
T <sub>ch</sub>	Operating Channel Temperature	°C		+150
T <sub>stg</sub>	Storage Case Temperature	°C	-65	+150
T <sub>max</sub>	Maximum Assembly Temp (60 sec max)	°C		+300

#### Note:

1. Operation in excess of any one of these conditions may result in permanent damage to this device.

### Features

- Input frequency range: 10–20 GHz
- Broad input power range: -9 to +7 dBm
- Output power: -1 to 0 dBm (Pin = +4dB)
- Fundamental suppression of 25 dBc
- 50 $\Omega$  input and output match
- Supply bias of -1.2V, 4.5V and 27 mA

### Applications

- Microwave radio systems
- Satellite VSAT, DBS Up/Down Link
- LMDS & Pt-Pt mmW Long Haul
- Broadband Wireless Access  
(including 802.16 and 802.20 WiMax)
- WLL and MMDS loops



#### Attention: Observe precautions for handling electrostatic sensitive devices.

ESD Machine Model (Class A)  
ESD Human Body Model (Class 0)  
Refer to Avago Application Note A004R:  
*Electrostatic Discharge Damage and Control.*

## AMMC-6140 DC Specifications/Physical Properties<sup>[1]</sup>

Symbol	Parameters and Test Conditions	Units	Min.	Typ.	Max.
$I_d$	Drain Supply Current (under any RF power drive and temperature) ( $V_d = 4.5V$ )	mA		27	40
$V_g$	Gate Supply Operating Voltage	V	-1.5	-1.2	-1.0
$\theta_{ch-b}$	Thermal Resistance <sup>[2]</sup> (Backside Temp. $T_b = 25^\circ C$ )	$^\circ C/W$		25	

### Notes:

1. Ambient operational temperature  $T_A = 25^\circ C$  unless otherwise noted.
2. Channel-to-backside Thermal Resistance ( $\theta_{ch-b}$ ) =  $26^\circ C/W$  at  $T_{channel}$  ( $T_c$ ) =  $34^\circ C$  as measured using infrared microscopy. Thermal Resistance at backside temperature ( $T_b$ ) =  $25^\circ C$  calculated from measured data.

## RF Specifications<sup>[3,4,5]</sup> ( $T_A = 25^\circ C$ , $V_d = 4.5 V$ , $I_{d(Q)} = 27 mA$ , $Z_0 = 50\Omega$ )

Symbol	Parameters and Test Conditions	Units	Minimum	Typical	Sigma
$f_{in}$	Input Frequency	GHz		10 to 20	
$f_{out}$	Output Frequency	GHz		20 to 40	
$P_o$	Output Power <sup>[6]</sup>	dBm	-2	-1	0.4
$f_o$	Fundamental Isolation (referenced to $P_o$ ):	20–36 GHz	20	30	5.0
		36–40 GHz	14	16	1.0
$3f_o$	3 <sup>rd</sup> Harmonic Isolation (referenced to $P_o$ )	dBc		25	1.2
$P_{-1dB}$	Output Power at 1dB Gain Compression	dBm		+5	
RLin	Input Return Loss <sup>[6]</sup>	dB		-15	
RLout	Output Return Loss <sup>[6]</sup>	dB		-10	
SSB	Single Sideband Phase Noise (100 KHz offset)	dBc/Hz		-135	

### Notes:

3. Small/large signal data measured in wafer form  $T_A = 25^\circ C$ .
4. 100% on-wafer RF test is done at  $P_{in} = +4 dBm$  and output frequency = 20, 28, 36 and 40 GHz.
5. Specifications are derived from measurements in a  $50\Omega$  test environment. Aspects of the multiplier performance may be improved over a narrower bandwidth by application of additional matching.

## Typical distribution of $P_{out}$ , 2<sup>nd</sup> Harmonic and 3<sup>rd</sup> Harmonic Suppression ( $f_{in} = 14 GHz$ ). Based on 2500 parts sampled over several production lots.

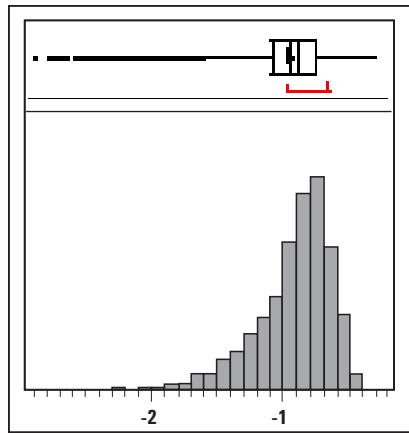

2Fo Pout (dBm) @ 28G Hz

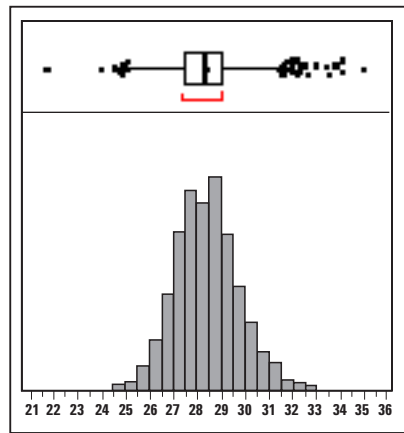

Fo Suppression (dBm) @ 14 GHz

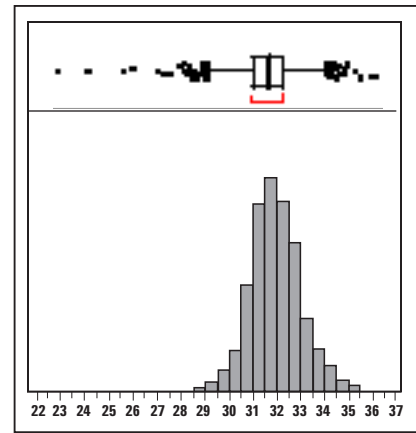

3Fo Suppression (dBm) @ 42 GHz



**AMMC-6140 Typical Performances** ( $T_A = 25^\circ\text{C}$ ,  $V_d = 4.5\text{V}$ ,  $I_D = 27\text{mA}$ ,  $V_g = -1.2\text{V}$ ,  $Z_{in} = Z_{out} = 50\Omega$  unless otherwise stated)

NOTE: These measurements are in a  $50\Omega$  test environment. Aspects of the multiplier performance may be improved over a narrower bandwidth by application of additional conjugate, linearity, or low noise ( $\Gamma_{opt}$ ) matching.

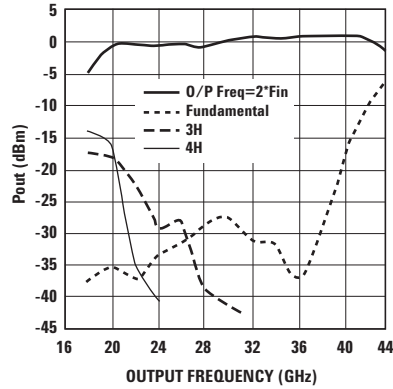

Figure 1. Typical Output Power against Fundamental, 3<sup>rd</sup>, and 4<sup>th</sup> Harmonic suppression ( $P_{in}=3\text{ dBm}$ ) vs. Frequency.

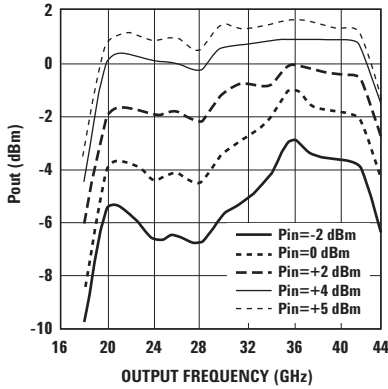

Figure 2. Typical Output Power at different Fundamental Input Power vs. Frequency.

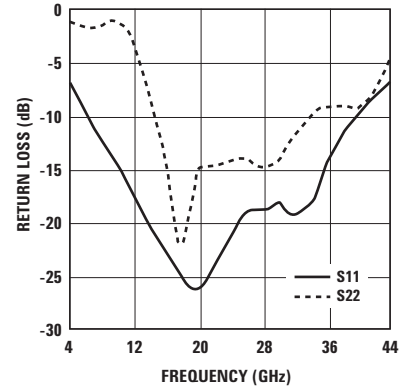

Figure 3. Typical Input & Output Return Loss.

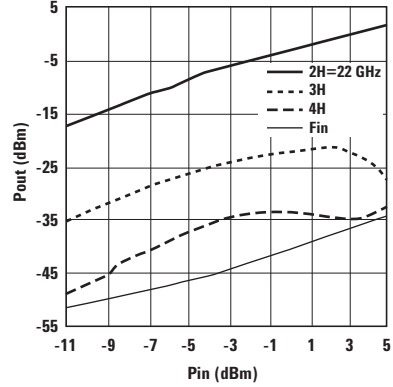

Figure 4. Typical Output Power against Fundamental 3<sup>rd</sup> and 4<sup>th</sup> Harmonic suppression vs.  $P_{in}$  (2H=22 GHz).

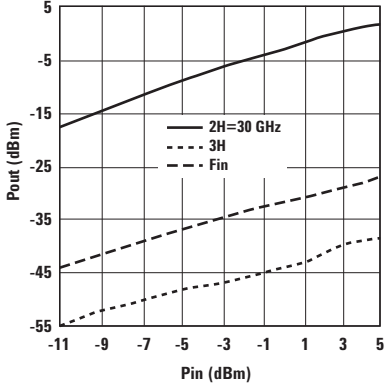

Figure 5. Typical Output Power against Fundamental and 3<sup>rd</sup> Harmonic vs.  $P_{in}$  (2H=30 GHz).

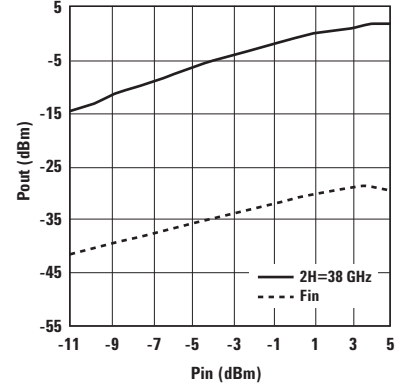

Figure 6. Typical Output Power against Fundamental vs.  $P_{in}$  (2H=38 GHz).

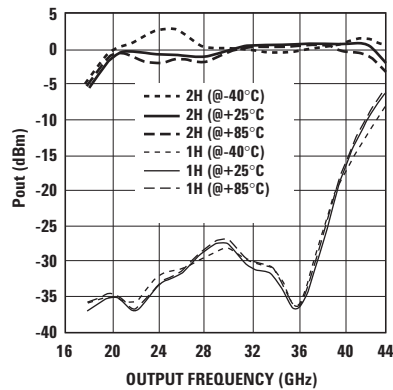

Figure 7. Typical Output Power and Fundamental Suppression vs. Temperature.

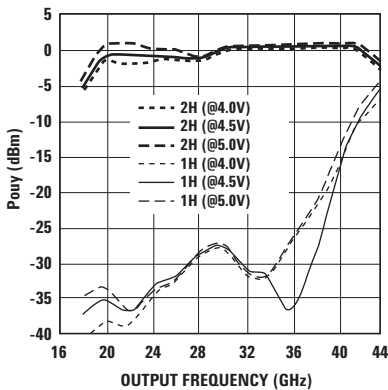

Figure 8. Typical Output Power and Fundamental Suppression vs.  $V_{dd}$ .

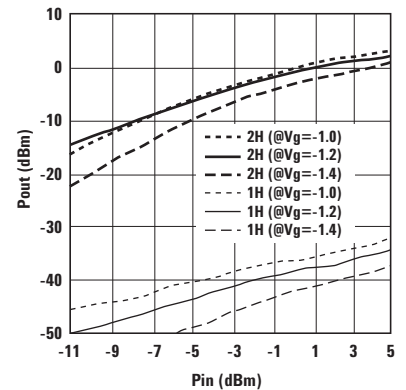
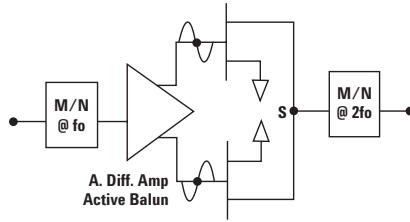

Figure 9. Typical Pout and Fundamental Suppression vs.  $V_g$  ( $F_{out}=38\text{ GHz}$ ).

## Biasing and Operation



The frequency doubler MMIC consists of a differential amplifier circuit that acts as an active balun. The outputs of this balun feed the gates of balanced FETs and the drains are connected to form the single-ended output. This results in the fundamental frequency and odd harmonics canceling and the even harmonic drain currents (in phase) adding in superposition. Node 'S' acts as a virtual ground. An input matching network (M/N) is designed to provide good match at fundamental frequencies and produces high impedance mismatch at higher harmonics.

AMMC-6140 is biased with a single positive drain supply and single negative gate supply using separate bypass capacitors. It is normally biased with the drain supply connected to the  $V_{DD}$  bond pad and the gate supply connected to the  $V_{gg}$  bond pad. It is important to have the 100 pF bypass capacitor and it should be placed as close to the die as possible. Typical bias connections are shown in Figure 12. For most of the application it is recommended to use a  $V_g = -1.2V$  and  $V_d = 4.5V$ .

The AMMC-6140 performance changes very slightly with Drain ( $V_d$ ) and Gate bias ( $V_g$ ) as shown in Figures 8 and 9. Minor improvements in performance are possible for output power or fundamental suppression by optimizing the  $V_g$  from  $-1.0V$  to  $-1.4V$  and/or  $V_d$  from  $4.0$  to  $5.0V$ .

The RF input and output ports are AC coupled, thus no DC voltage is present at either port. However, the RF output port has an internal output matching circuit that presents a DC short. Proper care should be taken while biasing a sequential circuit to the AMMC-6140 as it might cause a DC short (Use a DC block if sub sequential circuit is not AC coupled). No ground wires are needed since ground connections are made with plated through-holes to the backside of the device.

Refer to the Absolute Maximum Ratings table for allowed DC and thermal conditions.

## Assembly Techniques

The backside of the MMIC chip is RF ground. For microstrip applications the chip should be attached directly to the ground plane (e.g. circuit carrier or heatsink) using electrically conductive epoxy<sup>[1,2]</sup>.

For best performance, the topside of the MMIC should be brought up to the same height as the circuit surrounding it. This can be accomplished by mounting a gold plate metal shim (same length and width as the MMIC) under the chip which is of correct thickness to make the chip and adjacent circuit the same height. The amount of epoxy used for the chip and/or shim attachment should be just enough to provide a thin fillet around the bottom perimeter of the chip or shim. The ground plane should be free of any residue that may jeopardize electrical or mechanical attachment.

The location of the RF bond pads is shown in Figure 12. Note that all the RF input and output ports are in a Ground-Signal-Ground configuration.

RF connections should be kept as short as reasonable to minimize performance degradation due to undesirable series inductance. A single bond wire is normally sufficient for signal connections, however double bonding with 0.7 mil gold wire or use of gold mesh is recommended for best performance, especially near the high end of the frequency band.

Thermosonic wedge bonding is the preferred method for wire attachment to the bond pads. Gold mesh can be attached using a 2 mil round tracking tool and a tool force of approximately 22 grams and an ultrasonic power of roughly 55 dB for a duration of  $76 \pm 8$  mS. The guided wedge at an ultrasonic power level of 64 dB can be used for 0.7 mil wire. The recommended wire bond stage temperature is  $150 \pm 2^\circ C$ .

Caution should be taken to not exceed the Absolute Maximum Rating for assembly temperature and time.

The chip is 100  $\mu m$  thick and should be handled with care. This MMIC has exposed air bridges on the top surface and should be handled by the edges or with a custom collet (do not pick up the die with a vacuum on die center).

This MMIC is also static sensitive and ESD precautions should be taken.

### Notes:

1. Ablebond 84-1 LM1 silver epoxy is recommended.
2. Eutectic attach is not recommended and may jeopardize reliability of the device

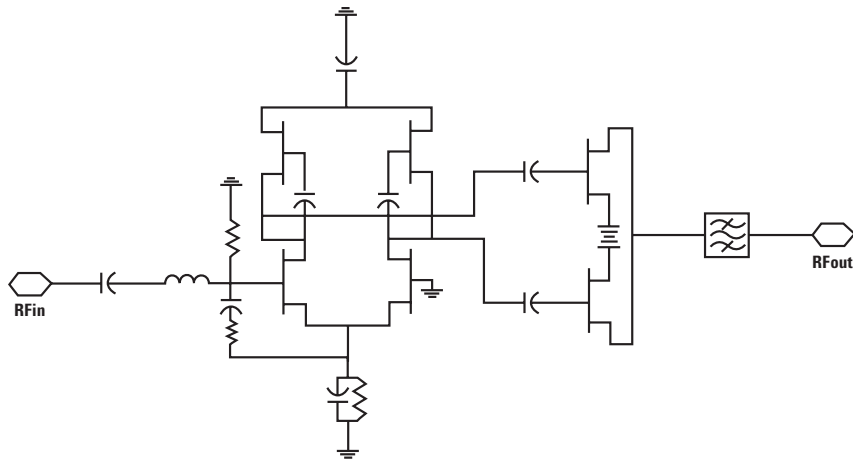

Figure 10. AMMC-6140 simplified schematic.

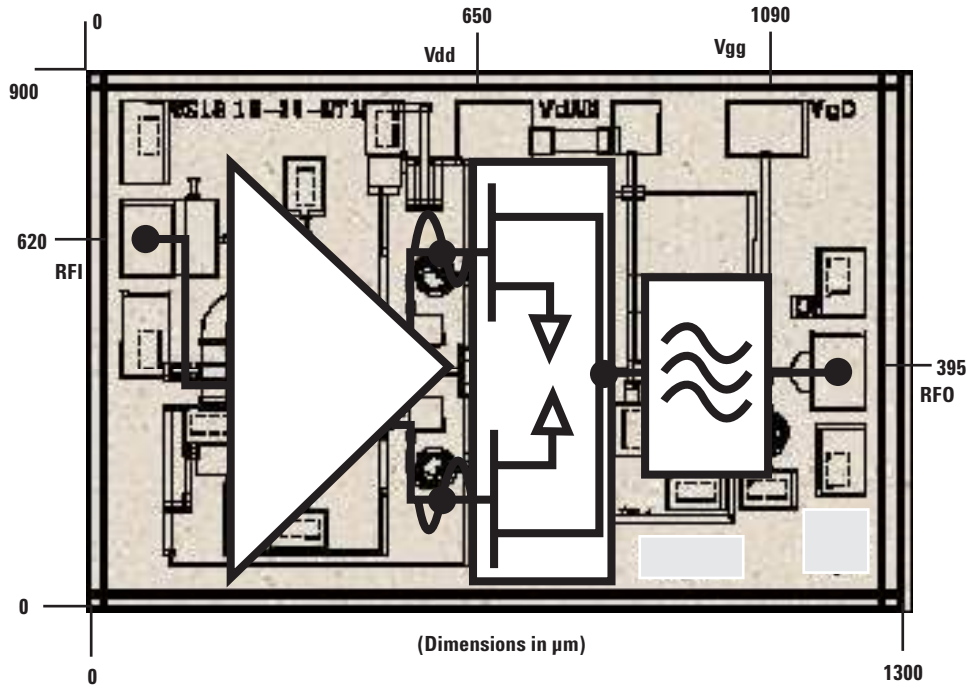
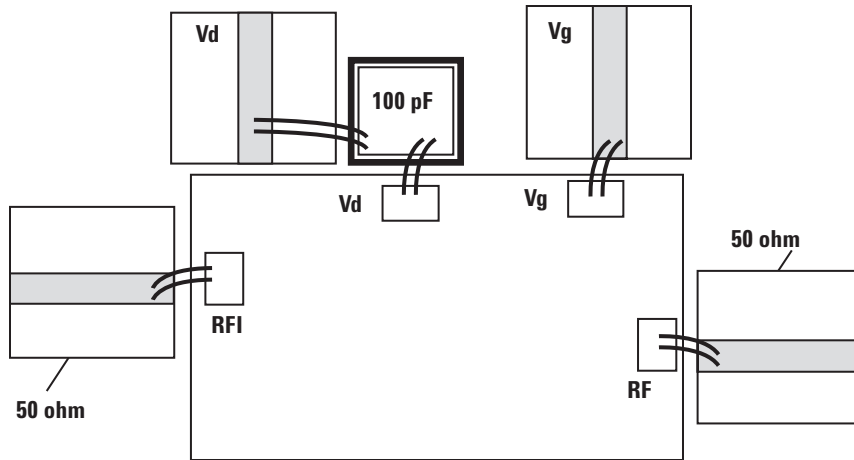

Figure 11. AMMC-6140 Bonding Pad Locations.



**Figure 12. AMMC-6140 Assembly Diagram.**

Note: 0.1uF capacitors on gate and drain lines, not shown, required.

**Ordering Information**

AMMC-6140-W10 = 10 devices per tray

AMMC-6140-W50 = 50 devices per tray

For product information and a complete list of distributors, please go to our web site: [www.avagotech.com](http://www.avagotech.com)

Avago, Avago Technologies, and the A logo are trademarks of Avago Technologies Limited in the United States and other countries. Data subject to change. Copyright © 2005-2008 Avago Technologies Limited. All rights reserved. Obsoletes 5989-3946EN AV02-0701EN - June 23, 2008

