



Chipsmall Limited consists of a professional team with an average of over 10 year of expertise in the distribution of electronic components. Based in Hongkong, we have already established firm and mutual-benefit business relationships with customers from,Europe,America and south Asia,supplying obsolete and hard-to-find components to meet their specific needs.

With the principle of “Quality Parts,Customers Priority,Honest Operation,and Considerate Service”,our business mainly focus on the distribution of electronic components. Line cards we deal with include Microchip,ALPS,ROHM,Xilinx,Pulse,ON,Everlight and Freescale. Main products comprise IC,Modules,Potentiometer,IC Socket,Relay,Connector.Our parts cover such applications as commercial,industrial, and automotives areas.

We are looking forward to setting up business relationship with you and hope to provide you with the best service and solution. Let us make a better world for our industry!



Contact us

Tel: +86-755-8981 8866 Fax: +86-755-8427 6832

Email & Skype: info@chipsmall.com Web: www.chipsmall.com

Address: A1208, Overseas Decoration Building, #122 Zhenhua RD., Futian, Shenzhen, China



AMMC - 6220

6 - 20 GHz Low Noise Amplifier



Data Sheet

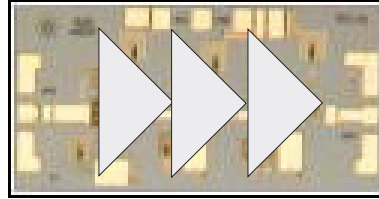

Chip Size: 1700 x 800 μm (67 x 31.5 mils)
Chip Size Tolerance: $\pm 10 \mu\text{m}$ (± 0.4 mils)
Chip Thickness: $100 \pm 10 \mu\text{m}$ (4 ± 0.4 mils)
Pad Dimensions: $100 \times 100 \mu\text{m}$ (4 ± 0.4 mils)

Description

Avago Technologies' AMMC-6220 is a high gain, low-noise amplifier that operates from 6 GHz to 20 GHz. This LNA provides a wide-band solution for system design since it covers several bands, thus, reduces part inventory. The device has input / output match to 50 Ohm, is unconditionally stable and can be used as either primary or sub-sequential low noise gain stage. By eliminating the complex tuning and assembly processes typically required by hybrid (discrete-FET) amplifiers, the AMMC-6220 is a cost-effective alternative in the 6 - 20 GHz communications receivers. The backside of the chip is both RF and DC ground. This helps simplify the assembly process and reduces assembly related performance variations and costs. It is fabricated in a PHEMT process to provide exceptional noise and gain performance. For improved reliability and moisture protection, the die is passivated at the active areas.

Features

- Wide frequency range: 6 - 20 GHz
- High gain: 23 dB
- Low 50 Ω Noise Figure: 2.0 dB
- 50 Ω Input and Output Match
- Single 3V Supply Bias

Applications

- Microwave Radio systems
- Satellite VSAT, DBS Up/Down Link
- LMDS & Pt-Pt mmW Long Haul
- Broadband Wireless Access (including 802.16 and 802.20 WiMax)
- WLL and MMDS loops

AMMC-6220 Absolute Maximum Ratings^[1]

Symbol	Parameters/Conditions	Units	Min.	Max.
V_d	Positive Drain Voltage	V		7
V_g	Gate Supply Voltage	V		NA
I_d	Drain Current	mA		100
P_{in}	CW Input Power	dBm		15
T_{ch}	Operating Channel Temp.	$^{\circ}\text{C}$		+150
T_{stg}	Storage Case Temp.	$^{\circ}\text{C}$	-65	+150
T_{max}	Maximum Assembly Temp (60 sec max)	$^{\circ}\text{C}$		+300

Note:

1. Operation in excess of any one of these conditions may result in permanent damage to this device



Note: These devices are ESD sensitive. The following precautions are strongly recommended. Ensure that an ESD approved carrier is used when dice are transported from one destination to another. Personal grounding is to be worn at all times when handling these devices

AMMC-6220 DC Specifications/Physical Properties [1]

Symbol	Parameters and Test Conditions	Units	Min.	Typ.	Max.
I_d	Drain Supply Current (under any RF power drive and temperature) ($V_d=3.0V$)	mA		55	70
V_g	Gate Supply Operating Voltage ($I_{d(Q)} = 800$ (mA))	V		NA	
q_{ch-b}	Thermal Resistance ^[2] (Backside temperature, $T_b = 25^\circ C$)	$^\circ C/W$		25	

Notes:

1. Ambient operational temperature $T_A=25^\circ C$ unless otherwise noted.
2. Channel-to-backside Thermal Resistance (q_{ch-b}) = $26^\circ C/W$ at $T_{channel} (T_c) = 34^\circ C$ as measured using infrared microscopy. Thermal Resistance at backside temperature (T_b) = $25^\circ C$ calculated from measured data.

AMMC-6220 RF Specifications [3, 4, 5] ($T_A= 25^\circ C$, $V_d=3.0V$, $I_{d(Q)}=55$ mA, $Z_0=50 \Omega$)

Symbol	Parameters and Test Conditions	Units	Minimum	Typical	Maximum	Sigma
Gain	Small-signal Gain ^[6]	dB	21	23		0.30
NF	Noise Figure into 50Ω	dB		7-10 GHz = 2.1 10-16 GHz = 1.8 16-20 GHz = 2.0	8 GHz = 2.4 12 GHz = 2.2 18 GHz = 2.4	0.10
P_{-1dB}	Output Power at 1dB Gain Compression	dBm		+9		0.87
OIP3	Third Order Intercept Point; $\Delta f=100MHz$; $P_{in}=-35dBm$	dBm		+19		1.20
RLin	Input Return Loss ^[6]	dB		-12	-10	0.31
RLout	Output Return Loss ^[6]	dB		-16	-10	0.68
Isol	Reverse Isolation ^[6]	dB		-45		0.50

Notes:

3. Small/Large -signal data measured in wafer form $T_A = 25^\circ C$.
4. 100% on-wafer RF test is done at frequency = 8, 12, and 18 GHz.
5. Specifications are derived from measurements in a 50Ω test environment. Aspects of the amplifier performance may be improved over a more narrow bandwidth by application of additional conjugate, linearity, or low noise (Γ_{opt}) matching.
6. As derived from measured s-parameters

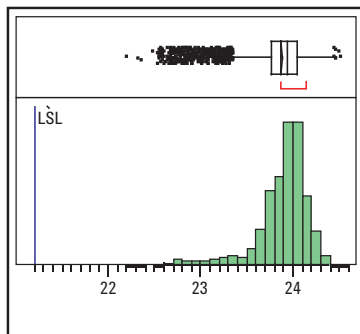

Gain at 12 GHz

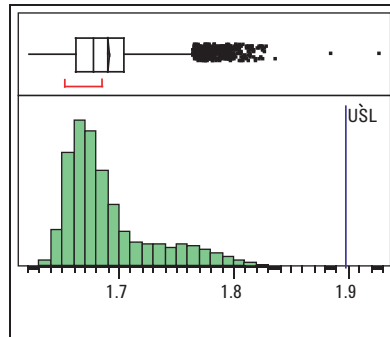

Noise Figure at 12 GHz

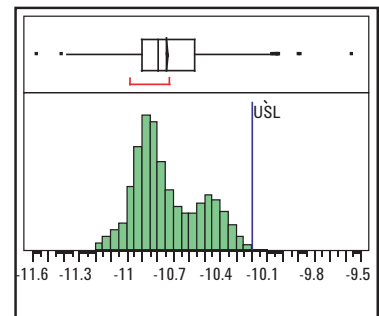

Return Loss at 12 GHz

Typical distribution of Small Signal Gain, Noise Figure, and Return Loss. Based on 1500 part sampled over several production lots.

AMMC-6220 Typical Performances

($T_A = 25^\circ\text{C}$, $V_d = 3.0\text{ V}$, $I_D = 55\text{ mA}$, $Z_{in} = Z_{out} = 50\ \Omega$ unless otherwise stated)

NOTE: These measurements are in a $50\ \Omega$ test environment. Aspects of the amplifier performance may be improved over a more narrow bandwidth by application of additional conjugate, linearity, or low noise (Γ_{opt}) matching. Figure 1. Typical Gain

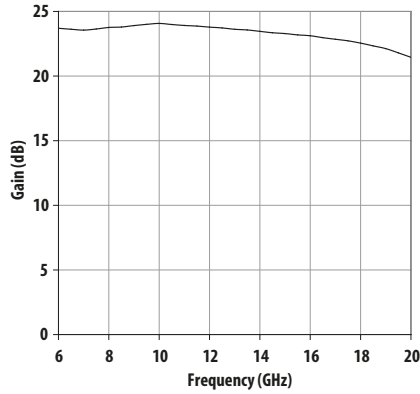

Figure 1. Typical Gain

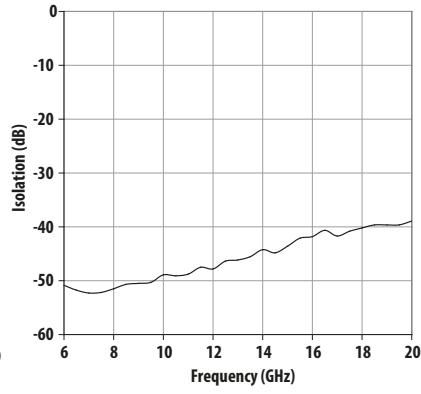

Figure 2. Typical Isolation

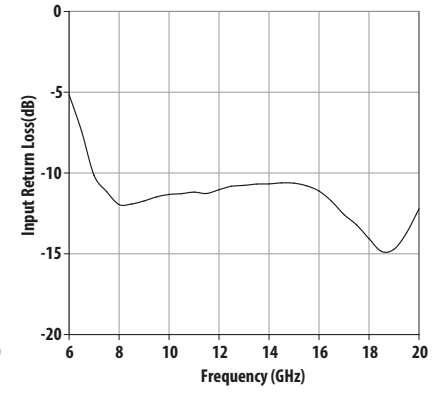

Figure 3. Typical Input Return Loss

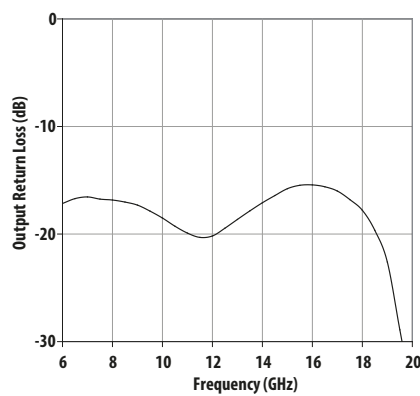

Figure 4. Typical Output Return Loss

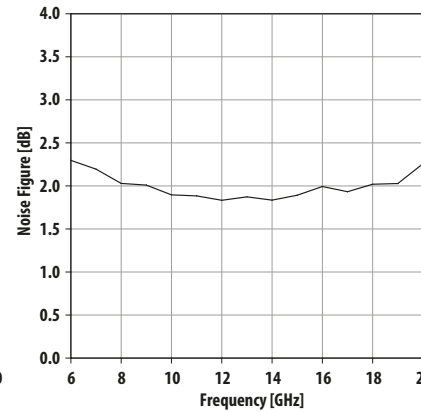

Figure 5. Typical Noise Figure into a 50 W load.

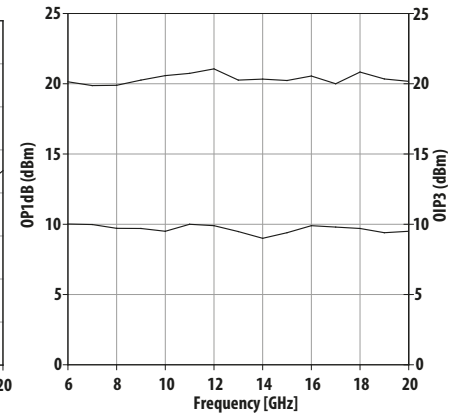

Figure 6. Typical Output P-1dB and 3rd Order Intercept Pt.

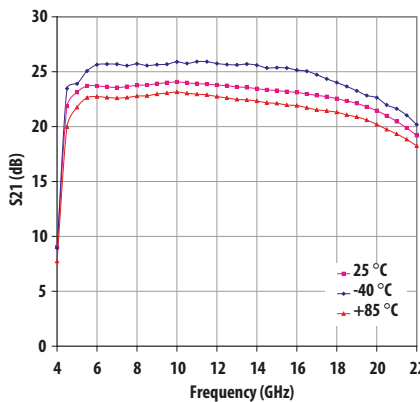

Figure 7. Typical Gain (s21) over temperature

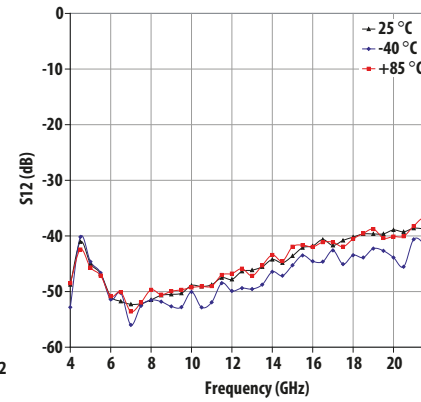

Figure 8. Typical Isolation (s12) over temperature

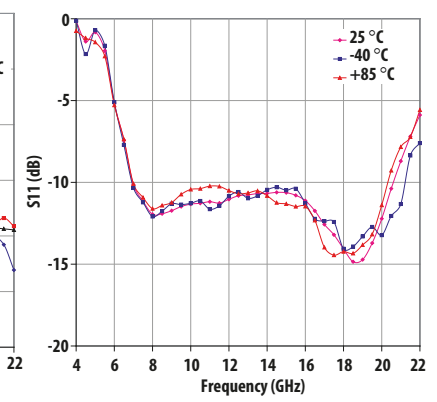

Figure 9. Typical Input Return Loss (s11) over temperature

AMMC-6220 Typical Performances

($T_A = 25^\circ\text{C}$, $V_d = 3.0\text{ V}$, $I_D = 55\text{ mA}$, $Z_{in} = Z_{out} = 50\Omega$ unless otherwise stated)

NOTE: These measurements are in a 50Ω test environment. Aspects of the amplifier performance may be improved over a more narrow bandwidth by application of additional conjugate, linearity, or low noise (Γ_{opt}) matching.

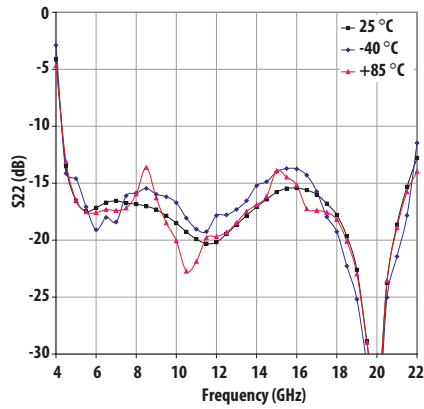

Figure 10. Typical Output Return Loss over Temperature

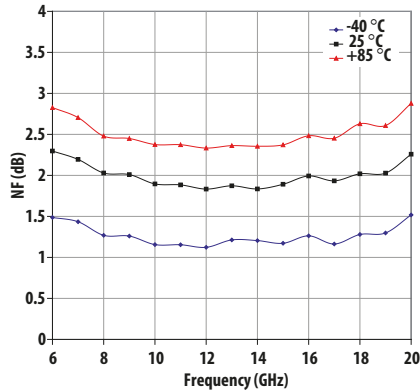

Figure 11. Typical Noise Figure over Temperature

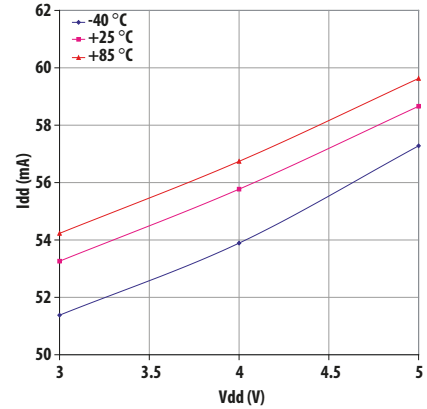

Figure 12. Typical Total Idd over Temperature

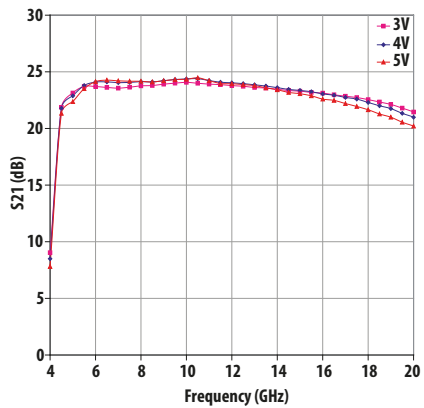

Figure 13. Typical Gain over Vdd (supply voltage.)

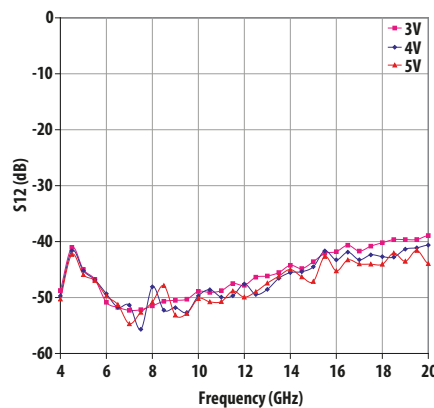

Figure 14. Typical Isolation over Vdd (supply voltage)

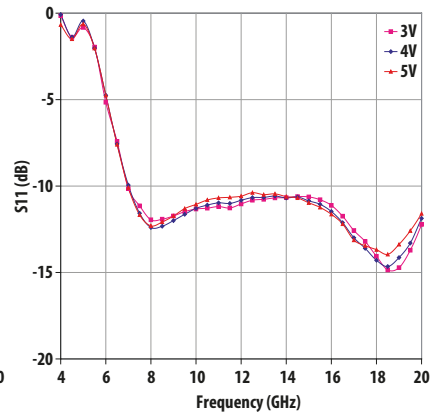

Figure 15. Typical Input Return Loss over Vdd (supply voltage)

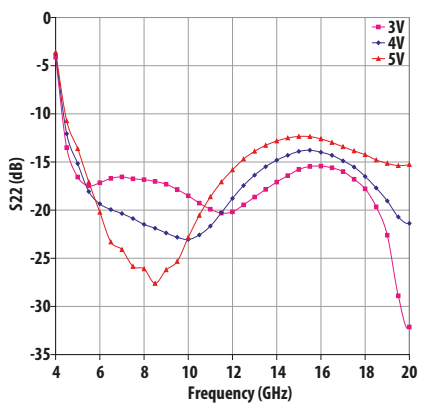

Figure 16. Typical Output Return Loss over Vdd (supply voltage)

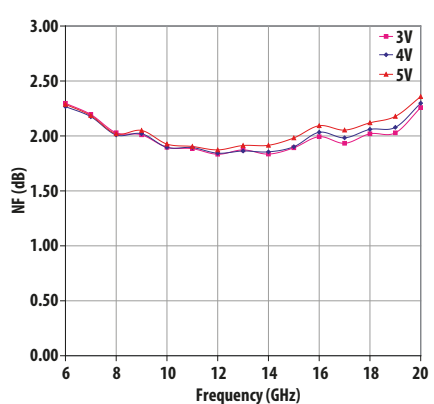

Figure 17. Typical Noise Figure over Vdd (supply voltage.)

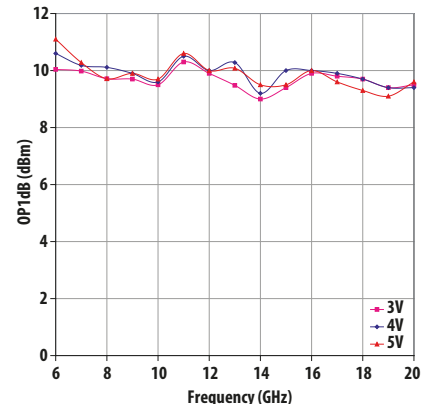

Figure 18. Typical OP_{1dB} over Vdd (supply voltage.)

AMMC-6220 Typical Scattering Parameters^[1]

(T_c=25°C, V_{D1}=V_{D2}= 3 V, Z_{in} = Z_{out} = 50 Ω)

Freq GHz	S11			S21			S12			S22		
	dB	Mag	Phase	dB	Mag	Phase	dB	Mag	Phase	dB	Mag	Phase
4.000	-0.146	0.983	103.687	9.033	2.829	-128.237	-48.748	0.004	-115.810	-4.132	0.621	171.001
4.500	-1.392	0.852	74.728	21.862	12.391	118.600	-41.044	0.009	103.896	-13.516	0.211	141.837
5.000	-0.823	0.910	37.284	23.130	14.338	39.967	-44.986	0.006	29.720	-16.564	0.149	168.028
5.500	-1.961	0.798	-3.456	23.710	15.328	-15.875	-46.775	0.005	-28.575	-17.481	0.134	-175.481
6.000	-5.151	0.553	-33.435	23.699	15.310	-59.866	-50.848	0.003	-45.938	-17.158	0.139	-166.821
6.500	-7.415	0.426	-53.353	23.622	15.174	-95.795	-51.753	0.003	-76.787	-16.707	0.146	-164.516
7.000	-10.150	0.311	-65.197	23.557	15.060	-126.279	-52.284	0.002	-109.752	-16.549	0.149	-165.262
7.500	-11.146	0.277	-71.056	23.641	15.207	-153.658	-52.173	0.002	-108.492	-16.750	0.145	-165.145
8.000	-11.953	0.253	-76.086	23.761	15.419	-179.298	-51.490	0.003	-134.195	-16.835	0.144	-165.958
8.500	-11.917	0.254	-79.875	23.793	15.475	156.812	-50.677	0.003	-149.675	-17.025	0.141	-166.708
9.000	-11.731	0.259	-85.876	23.908	15.681	133.712	-50.500	0.003	-159.105	-17.310	0.136	-167.942
9.500	-11.478	0.267	-93.111	24.000	15.849	111.612	-50.296	0.003	-171.408	-17.862	0.128	-168.952
10.000	-11.328	0.271	-100.430	24.071	15.979	90.667	-48.911	0.004	-176.724	-18.509	0.119	-168.793
10.500	-11.278	0.273	-107.107	23.989	15.829	70.398	-49.083	0.004	174.601	-19.271	0.109	-166.105
11.000	-11.184	0.276	-114.292	23.915	15.695	50.874	-48.773	0.004	155.804	-19.908	0.101	-161.607
11.500	-11.267	0.273	-119.551	23.867	15.607	31.947	-47.506	0.004	155.799	-20.309	0.097	-153.779
12.000	-11.033	0.281	-125.024	23.786	15.464	14.018	-47.811	0.004	150.219	-20.177	0.098	-146.759
12.500	-10.820	0.288	-130.580	23.724	15.354	-3.874	-46.361	0.005	124.708	-19.456	0.106	-141.031
13.000	-10.768	0.289	-136.143	23.620	15.170	-20.953	-46.149	0.005	119.468	-18.642	0.117	-137.531
13.500	-10.685	0.292	-140.774	23.568	15.081	-37.794	-45.536	0.005	120.694	-17.844	0.128	-136.674
14.000	-10.672	0.293	-147.067	23.459	14.891	-54.252	-44.238	0.006	108.871	-17.088	0.140	-136.397
14.500	-10.611	0.295	-151.974	23.351	14.707	-70.766	-44.824	0.006	98.487	-16.419	0.151	-137.700
15.000	-10.629	0.294	-157.342	23.287	14.600	-86.927	-43.591	0.007	85.314	-15.782	0.163	-140.788
15.500	-10.792	0.289	-164.023	23.184	14.428	-102.737	-42.101	0.008	81.787	-15.469	0.168	-145.110
16.000	-11.118	0.278	-169.248	23.119	14.320	-119.061	-41.806	0.008	64.948	-15.429	0.169	-150.386
16.500	-11.744	0.259	-173.681	22.973	14.082	-135.063	-40.650	0.009	63.398	-15.606	0.166	-156.073
17.000	-12.571	0.235	-176.840	22.847	13.879	-151.033	-41.699	0.008	48.516	-16.000	0.158	-160.598
17.500	-13.207	0.219	-179.413	22.728	13.689	-166.718	-40.813	0.009	43.851	-16.795	0.145	-166.616
18.000	-14.063	0.198	-176.351	22.548	13.409	176.850	-40.203	0.010	34.195	-17.791	0.129	-173.574
18.500	-14.853	0.181	-172.040	22.336	13.086	160.709	-39.642	0.010	21.429	-19.662	0.104	178.090
19.000	-14.720	0.184	-161.713	22.122	12.767	144.491	-39.641	0.010	20.910	-22.604	0.074	169.680
19.500	-13.710	0.206	-153.813	21.797	12.298	128.151	-39.632	0.010	8.070	-28.897	0.036	148.784
20.000	-12.221	0.245	-148.391	21.451	11.819	111.521	-38.926	0.011	-7.980	-35.137	0.018	31.294
20.500	-10.382	0.303	-147.276	20.983	11.198	95.148	-39.251	0.011	-13.094	-23.741	0.065	-15.174
21.000	-8.701	0.367	-150.640	20.472	10.558	78.624	-38.616	0.012	-25.399	-18.636	0.117	-26.892
21.500	-7.194	0.437	-156.785	19.879	9.862	62.593	-38.726	0.012	-35.505	-15.322	0.171	-36.809
22.000	-5.883	0.508	-163.716	19.198	9.118	47.073	-38.915	0.011	-38.784	-12.780	0.230	-45.747

Note: Data obtained from on-wafer measurements

AMMC-6220: Typical Scattering Parameters^[1]
 (T_C=25°C, V_{D1}=V_{D2}= 5 V, Z_{in} = Z_{out} = 50 Ω)

Freq GHz	S11			S21			S12			S22		
	dB	mag	phase	dB	mag	phase	dB	mag	phase	dB	mag	phase
4.0	-0.673	0.925	103.544	8.514	2.665	-130.371	-50.551	0.003	-109.410	-3.600	0.661	170.277
4.5	-1.492	0.842	74.318	21.395	11.742	117.926	-43.657	0.007	103.138	-10.722	0.291	137.294
5.0	-0.635	0.929	37.411	22.845	13.875	43.305	-45.849	0.005	43.526	-13.626	0.208	140.892
5.5	-2.032	0.791	-3.432	23.951	15.759	-11.567	-48.892	0.004	-22.501	-17.072	0.140	136.619
6.0	-4.747	0.579	-34.664	24.262	16.335	-56.971	-49.740	0.003	-50.634	-20.223	0.097	138.857
6.5	-7.598	0.417	-55.144	24.334	16.471	-94.487	-51.629	0.003	-90.737	-23.311	0.068	145.708
7.0	-10.093	0.313	-66.567	24.292	16.392	-126.702	-54.247	0.002	-108.004	-26.096	0.050	152.950
7.5	-11.669	0.261	-72.043	24.333	16.468	-155.390	-52.202	0.002	-121.340	-29.853	0.032	167.732
8.0	-12.300	0.243	-74.699	24.406	16.606	178.048	-51.151	0.003	-137.135	-33.106	0.022	-157.216
8.5	-12.080	0.249	-78.056	24.422	16.639	153.532	-52.505	0.002	-155.276	-31.608	0.026	-119.404
9.0	-11.733	0.259	-84.004	24.477	16.744	129.984	-51.516	0.003	-155.878	-28.205	0.039	-97.950
9.5	-11.303	0.272	-91.544	24.511	16.810	107.486	-52.868	0.002	-177.492	-25.326	0.054	-87.835
10.0	-11.062	0.280	-99.362	24.549	16.883	86.003	-51.015	0.003	175.740	-22.836	0.072	-83.845
10.5	-10.806	0.288	-106.223	24.467	16.724	65.381	-50.416	0.003	169.269	-20.540	0.094	-82.739
11.0	-10.685	0.292	-113.824	24.397	16.590	45.507	-50.539	0.003	161.489	-18.620	0.117	-83.562
11.5	-10.652	0.293	-120.486	24.282	16.372	26.125	-49.084	0.004	140.732	-17.073	0.140	-86.634
12.0	-10.584	0.296	-126.927	24.165	16.152	7.602	-49.630	0.003	129.430	-15.819	0.162	-91.173
12.5	-10.383	0.303	-133.049	24.037	15.916	-10.789	-49.737	0.003	117.272	-14.698	0.184	-95.581
13.0	-10.495	0.299	-139.396	23.885	15.641	-28.235	-47.563	0.004	112.685	-13.888	0.202	-100.779
13.5	-10.452	0.300	-144.569	23.757	15.412	-45.463	-47.315	0.004	114.739	-13.275	0.217	-106.161
14.0	-10.610	0.295	-150.864	23.582	15.104	-62.199	-48.035	0.004	101.112	-12.824	0.228	-111.602
14.5	-10.688	0.292	-155.580	23.400	14.792	-79.220	-47.535	0.004	89.549	-12.509	0.237	-116.032
15.0	-10.967	0.283	-161.115	23.239	14.519	-95.555	-46.791	0.005	88.406	-12.349	0.241	-121.314
15.5	-11.235	0.274	-166.831	23.018	14.154	-111.710	-45.741	0.005	82.235	-12.368	0.241	-126.026
16.0	-11.633	0.262	-170.420	22.817	13.831	-128.090	-45.071	0.006	65.758	-12.610	0.234	-130.007
16.5	-12.194	0.246	-173.577	22.522	13.369	-144.087	-46.403	0.005	65.253	-12.974	0.225	-132.934
17.0	-13.128	0.221	-174.413	22.241	12.944	-159.749	-44.636	0.006	52.243	-13.422	0.213	-134.003
17.5	-13.449	0.213	-173.665	21.974	12.552	-175.168	-44.918	0.006	40.428	-13.851	0.203	-134.954
18.0	-13.681	0.207	-169.464	21.613	12.041	169.124	-44.953	0.006	41.677	-14.243	0.194	-134.370
18.5	-13.952	0.201	-166.852	21.241	11.536	154.065	-44.297	0.006	28.636	-14.790	0.182	-132.741
19.0	-13.377	0.214	-162.360	20.881	11.067	139.077	-44.325	0.006	18.417	-15.145	0.175	-128.824
19.5	-12.587	0.235	-158.579	20.458	10.541	124.370	-44.648	0.006	17.829	-15.378	0.170	-124.591
20.0	-11.593	0.263	-155.670	20.070	10.080	109.618	-44.290	0.006	7.552	-15.265	0.172	-118.577
20.5	-10.402	0.302	-156.118	19.610	9.561	95.315	-43.949	0.006	4.072	-14.896	0.180	-112.117
21.0	-9.292	0.343	-158.544	19.157	9.075	81.210	-44.129	0.006	2.016	-14.201	0.195	-108.617
21.5	-8.122	0.393	-161.368	18.767	8.677	66.820	-43.714	0.007	-6.903	-13.518	0.211	-105.366
22.0	-7.019	0.446	-165.866	18.255	8.180	53.298	-43.878	0.006	-4.490	-12.580	0.235	-102.937

Note: Data obtained from on-wafer measurements

Biasing and Operation

The AMMC-6220 is normally biased with a single positive drain supply connected to both V_{D1} and V_{D2} bond pads through the 2 bypass capacitors as shown in Figure 20. The recommended supply voltage is 3 V. It is important to have 2 separate 100pF bypass capacitors, and these two capacitors should be placed as close to the die as possible.

The AMMC-6220 does not require a negative gate voltage to bias any of the three stages. No ground wires are needed because all ground connections are made with plated through-holes to the backside of the device.

Refer the Absolute Maximum Ratings table for allowed DC and thermal conditions

Assembly Techniques

The backside of the MMIC chip is RF ground. For microstrip applications the chip should be attached directly to the ground plane (e.g. circuit carrier or heatsink) using electrically conductive epoxy^[1,2]

For best performance, the topside of the MMIC should be brought up to the same height as the circuit surrounding it. This can be accomplished by mounting a gold plate metal shim (same length and width as the MMIC) under the chip which is of correct thickness to make the chip and adjacent circuit the same height. The amount of epoxy used for the chip and/or shim attachment should be just enough to provide a thin fillet around the bottom perimeter of the chip or shim. The ground plan should be free of any residue that may jeopardize electrical or mechanical attachment.

The location of the RF bond pads is shown in Figure 12. Note that all the RF input and output ports are in a Ground-Signal-Ground configuration.

RF connections should be kept as short as reasonable to minimize performance degradation due to undesirable series inductance. A single bond wire is normally sufficient for signal connections, however double bonding with 0.7 mil gold wire or use of gold mesh is recommended for best performance, especially near the high end of the frequency band.

Thermosonic wedge bonding is preferred method for wire attachment to the bond pads. Gold mesh can be attached using a 2 mil round tracking tool and a tool force of approximately 22 grams and a ultrasonic power of roughly 55 dB for a duration of 76 ± 8 mS. The guided wedge at an ultrasonic power level of 64 dB can be used for 0.7 mil wire. The recommended wire bond stage temperature is 150 ± 2 °C.

Caution should be taken to not exceed the Absolute Maximum Rating for assembly temperature and time.

The chip is 100um thick and should be handled with care. This MMIC has exposed air bridges on the top surface and should be handled by the edges or with a custom collet (do not pick up the die with a vacuum on die center).

This MMIC is also static sensitive and ESD precautions should be taken.

Notes:

1. Ablebond 84-1 LM1 silver epoxy is recommended.
2. Eutectic attach is not recommended and may jeopardize reliability of the device.

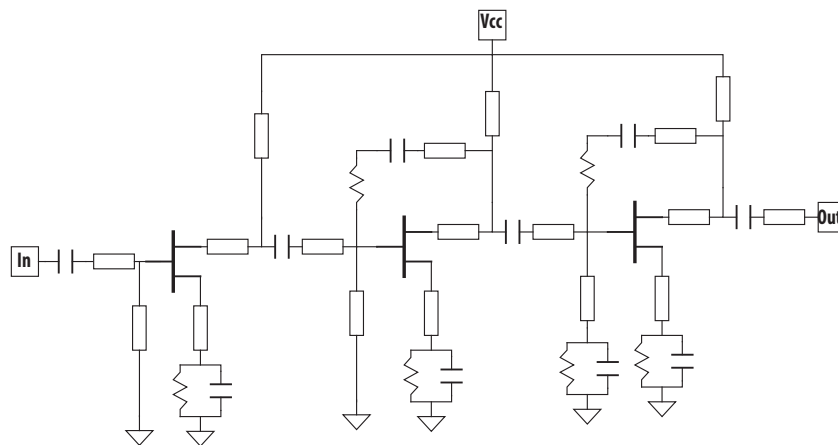

Figure 19. AMMC-6220 Schematic

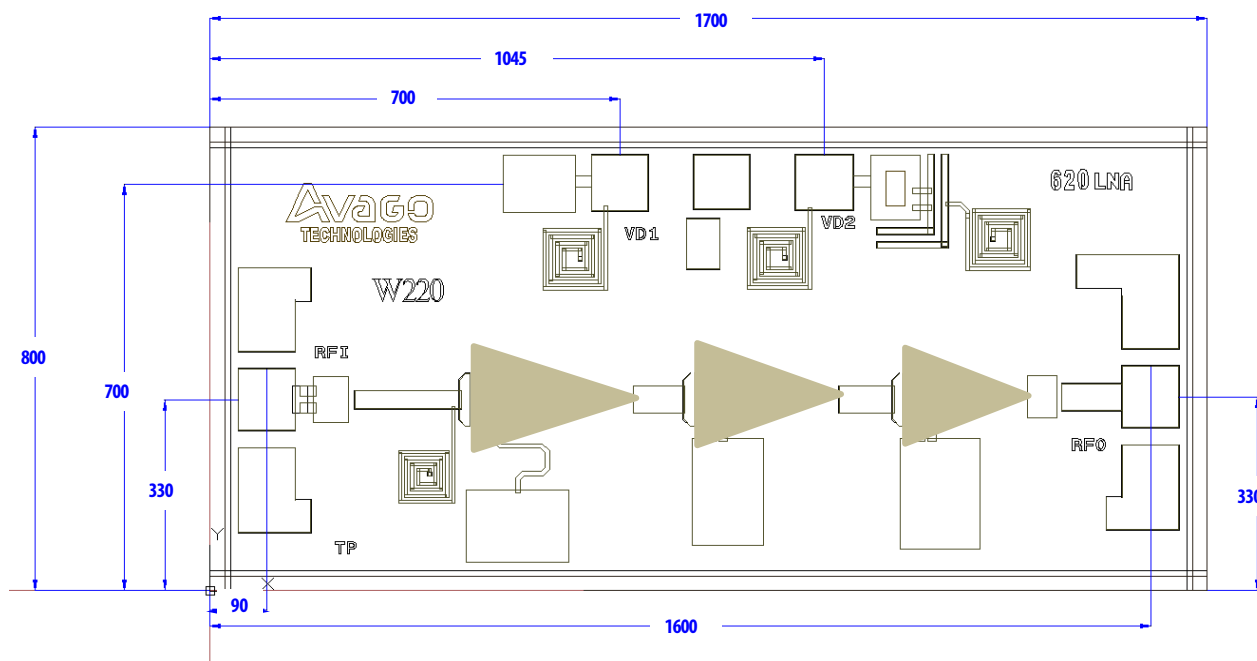

Figure 20. AMMC-6220 Bonding pad locations

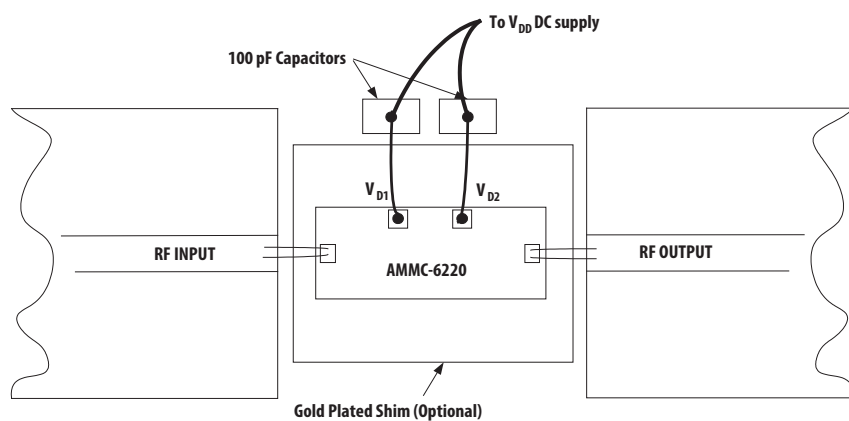

Figure 21. AMMC-6220 Assembly diagram

Ordering Information:

AMMC-6220-W10 = 10 devices per tray

AMMC-6220-W50 = 50 devices per tray

For product information and a complete list of distributors, please go to our web site: www.avagotech.com

Avago, Avago Technologies, and the A logo are trademarks of Avago Technologies Limited in the United States and other countries. Data subject to change. Copyright © 2005-2014 Avago Technologies Limited. All rights reserved. Obsoletes AV01-0218EN AV02-1287EN - November 18, 2014

