



Chipsmall Limited consists of a professional team with an average of over 10 year of expertise in the distribution of electronic components. Based in Hongkong, we have already established firm and mutual-benefit business relationships with customers from,Europe,America and south Asia,supplying obsolete and hard-to-find components to meet their specific needs.

With the principle of “Quality Parts,Customers Priority,Honest Operation,and Considerate Service”,our business mainly focus on the distribution of electronic components. Line cards we deal with include Microchip,ALPS,ROHM,Xilinx,Pulse,ON,Everlight and Freescale. Main products comprise IC,Modules,Potentiometer,IC Socket,Relay,Connector.Our parts cover such applications as commercial,industrial, and automotives areas.

We are looking forward to setting up business relationship with you and hope to provide you with the best service and solution. Let us make a better world for our industry!



## Contact us

Tel: +86-755-8981 8866 Fax: +86-755-8427 6832

Email & Skype: info@chipsmall.com Web: www.chipsmall.com

Address: A1208, Overseas Decoration Building, #122 Zhenhua RD., Futian, Shenzhen, China



# AMMC-6640

## DC-50 GHz Variable Attenuator



## Data Sheet

### Description

The AMMC-6640 MMIC is a monolithic, voltage variable, GaAs IC attenuator that operates from DC-50 GHz. It is fabricated using Avago Technologies enhancement mode MMIC process with backside ground vias, and gate lengths of approximately 0.25 $\mu$ m. The attenuator has a distributed topology and it helps to absorb parasitic effects of its series and shunt FETs to make it broadband.

### AMMC-6640 MMIC

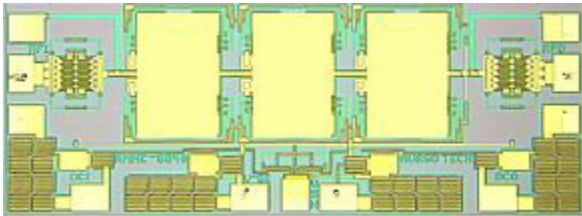

**Chip Size:** 1955  $\mu$ m x 790  $\mu$ m (80 x 31.1 mils)

**Chip Size Tolerance:**  $\pm$ 10  $\mu$ m ( $\pm$ 0.4 mils)

**Chip Thickness:** 100  $\pm$  10  $\mu$ m (4  $\pm$ 0.4 mils)

**Pad Dimensions:** 87 x 122  $\mu$ m (3.4 x 4 mils)

### Features

- Wide Frequency Range : DC-50 GHz
- I.L. : 4dB @ 50GHz
- Attenuation Range : >20dB
- IIP3 : >25dBm
- P1dB : >26dBm
- Dual Positive Control Voltages

### Applications

- Microwave Radio Systems
- Satellite VSAT, DBS Up / Down Link
- LMDS & Pt – Pt mmW Long Haul
- Broadband Wireless Access (including 802.16 and 802.20 WiMax)
- WLL and MMDS loops



**Attention: Observe Precautions for handling electrostatic sensitive devices.**

ESD Machine Model (Class A): 50V

ESD Human Body Model (Class 1A): 250V

Refer to Avago Application Note A004R:

*Electrostatic Discharge Damage and Control.*

**Table 1. AMMC-6640 Absolute Maximum Ratings [1]**

Symbol	Parameters	Unit	Minimum	Maximum
V <sub>C</sub>	Voltage to Control VSWR	V	0	2.5
P <sub>in</sub>	RF Input Power	dBm	–	30
T <sub>ch</sub>	Operating Channel Temperature	°C	–	+150
T <sub>stg</sub>	Storage Temperature	°C	-40	+150
T <sub>max</sub>	Maximum Assembly Temperature	°C		+260 for 60s

Note:

1. Operation in excess of any one of these conditions may result in permanent damage to this device. The absolute maximum ratings for V<sub>C</sub> and P<sub>in</sub> were determined at an ambient temperature of 25°C unless noted otherwise.

**Table 2. AMMC-6640 DC Specifications [1, 2]**

Symbol	Parameters	Test Conditions	Unit	Min	Typical	Max
I <sub>c_Vse</sub>	V <sub>se</sub> Control Current (Min Attenuation)	V <sub>se</sub> =1.2 V, V <sub>sh</sub> =0	μA	–	–	10.0
I <sub>c_Vse</sub>	V <sub>se</sub> Control Current (Max Attenuation)	V <sub>se</sub> =0 V, V <sub>sh</sub> =1.2V	mA	–	–	1.5
I <sub>c_Vsh</sub>	V <sub>sh</sub> Control Current (Min Attenuation)	V <sub>sh</sub> =0 V, V <sub>se</sub> =1.2V	μA	–	–	10.0
I <sub>c_Vsh</sub>	V <sub>sh</sub> Control Current (Max Attenuation)	V <sub>sh</sub> =1.2V, V <sub>se</sub> =0	mA	–	–	1.5

Notes:

1. Ambient operation temperature T<sub>A</sub> = 25°C unless otherwise noted.
2. Data obtained from on-wafer measurements.

**Table 3. AMMC-6640 RF Specifications [1, 2]**

Small/Large -signal data measured on-wafer at T<sub>A</sub> = 25°C, Z<sub>0</sub> = 50Ω

Symbol	Parameters and Test Conditions	Units	Freq. [GHz]	Minimum	Typical	Maximum
Minimum Attenuation (Reference State)	Small-signal S21 V <sub>se</sub> = 1.2 V, V <sub>sh</sub> = 0	dB	6		1.5	2.5
			28		2.5	3.5
			26		3	4
			38		3.35	4.5
			50		4	5.3
Maximum Attenuation	Small-signal S21 V <sub>se</sub> = 0 V, V <sub>sh</sub> = 1.2V	dB	6	23	25.5	
			18	23	25.5	
			26	23	26	
			38	23	26	
			50	24	28	
RL <sub>in</sub> and RL <sub>out</sub> At Minimum Attenuation	V <sub>se</sub> = 1.2V, V <sub>sh</sub> = 0V	dB	<50		12	
RL <sub>in</sub> and RL <sub>out</sub> At Maximum Attenuation	V <sub>se</sub> = 0V, V <sub>sh</sub> = 1.2V	dB	<50		10	
IIP3 at Minimum Attenuation		dBm	<38		30	
P1dB (input) at Minimum Attenuation		dBm	<40		27	
P1dB (input) at Maximum Attenuation		dBm	<40		27	

## Typical Distribution Charts

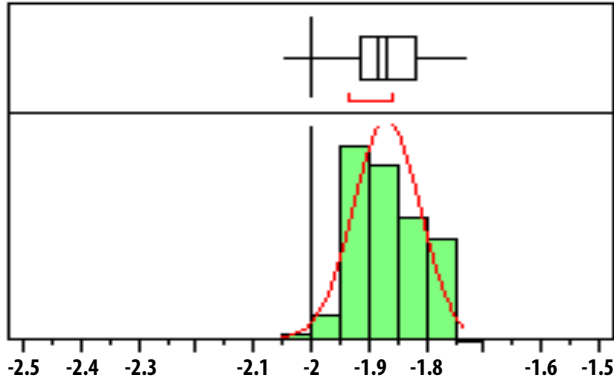

Figure 1. Min Attenuation @ 6GHz, Nominal=-1.9, LSL=-3.0

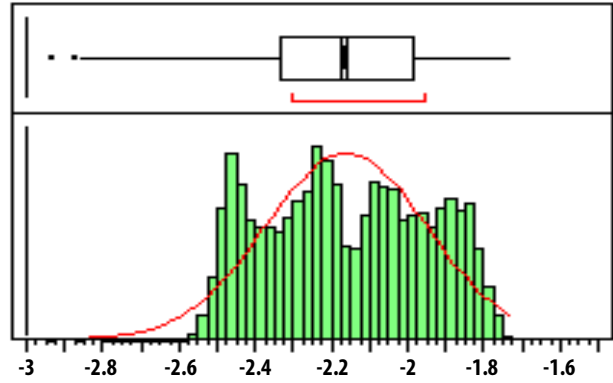

Figure 2. Min Attenuation @ 18GHz, Nominal=-2.2, LSL=-3.0

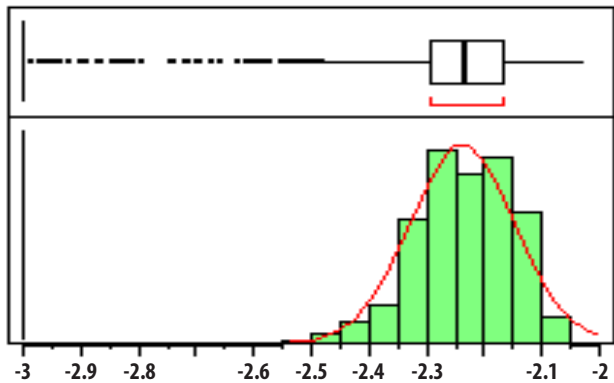

Figure 3. Min Attenuation @ 26GHz, Nominal=-2.2, LSL=-3.0

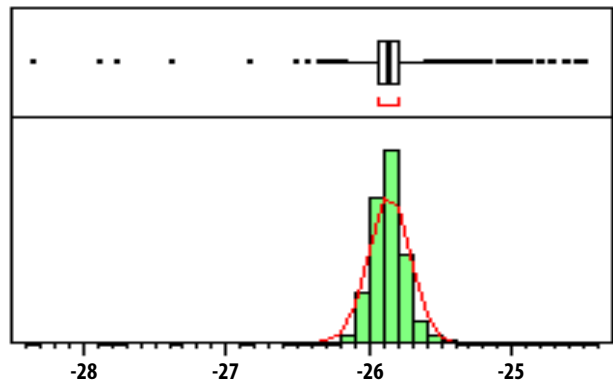

Figure 4. Max Attenuation @ 6GHz, Nominal=-26, USL=-23.0

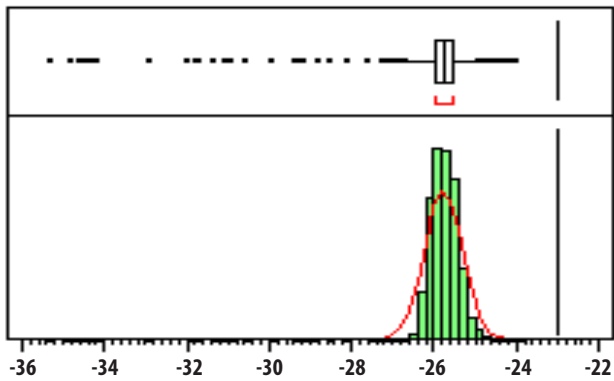

Figure 5. Max Attenuation @ 18GHz, Nominal=-25.8, USL=-23.0

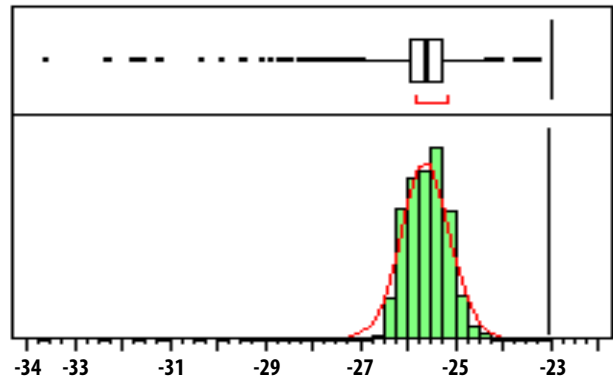

Figure 6. Max Attenuation @ 26GHz, Nominal=-25.6, USL=-23.0

### Notes:

1. Attenuation is a positive number; whereas,  $S_{21}$  as measured on a Network Analyzer would be a negative number.
2. Data obtained from on-wafer measurements.
3. Distribution data based on 5000 part sample size from two wafer lots during initial characterization of this product. Future wafers allocated to this product may have nominal values anywhere between upper and lower limits.



AMMC-6640 Typical Performance ( $T_A = 25^\circ\text{C}$ ,  $Z_{in} = Z_{out} = 50 \Omega$ )

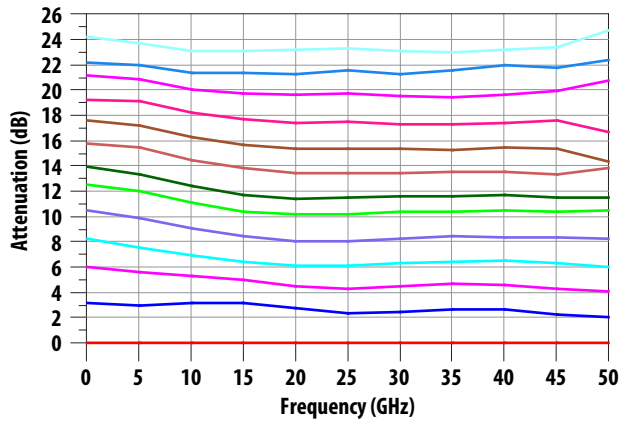

Attenuation (dB)	Vseries (V)	Vshunt (V)
0	1.2	0
2	0.440	0.325
4	0.435	0.383
6	0.430	0.416
8	0.420	0.440
10	0.410	0.465
12	0.400	0.480
14	0.385	0.505
16	0.375	0.535
18	0.360	0.575
20	0.350	0.650
22	0.346	0.845
max	0	1.2

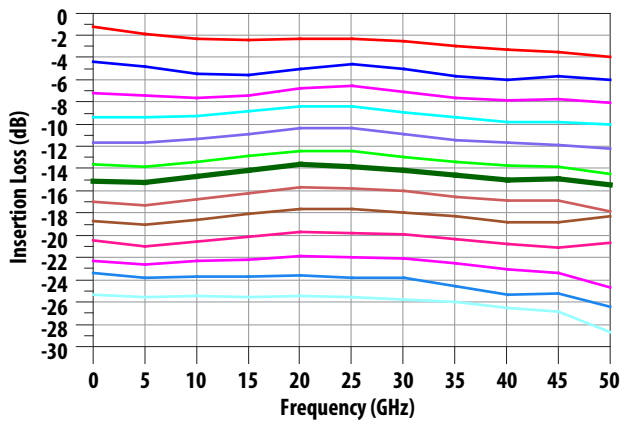

Figure 7a and 7b. Attenuation vs Frequency and Insertion Loss vs Frequency

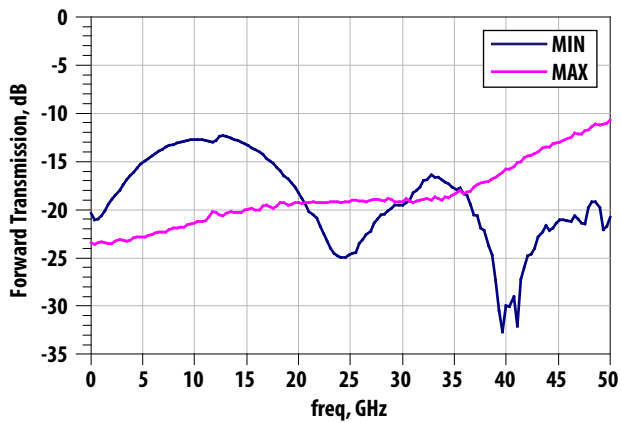

Figure 8. S11 vs Frequency

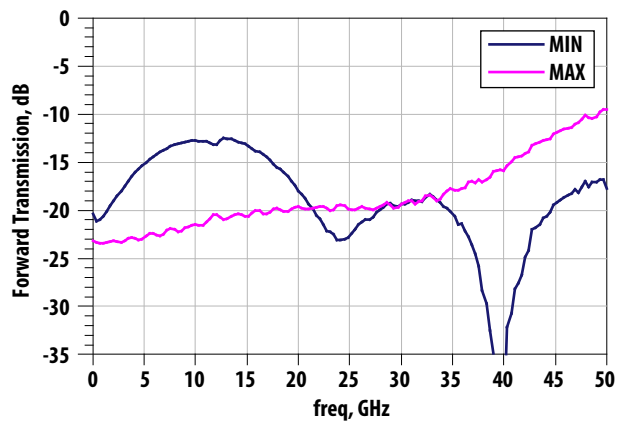

Figure 9. S22 vs Frequency

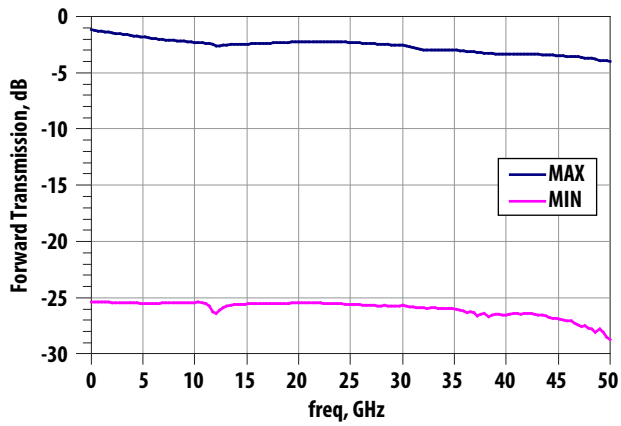

Figure 10. Insertion Loss vs Frequency

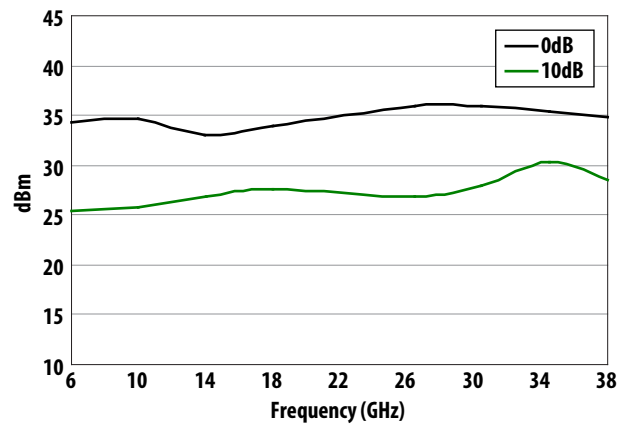

Figure 11. IIP3 vs Attenuation Input Power = 0dB

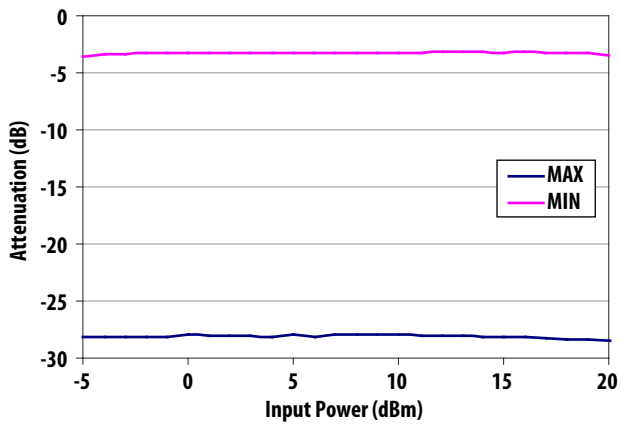

Figure 12a. Attenuation vs Input Power (Frequency = 6 GHz)

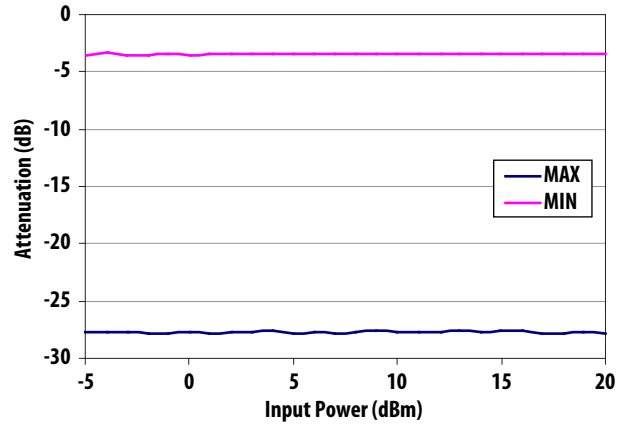

Figure 12b. Attenuation vs Input Power (Frequency = 18 GHz)

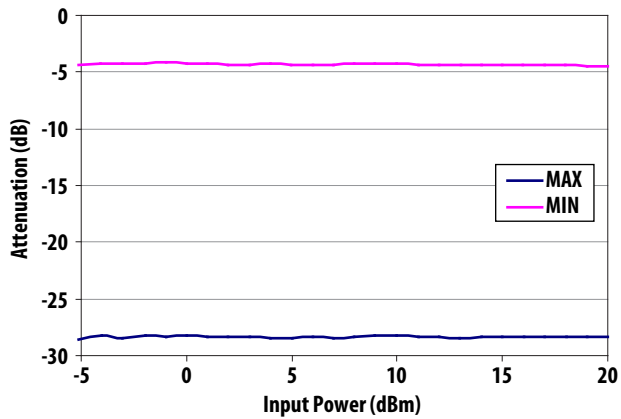

Figure 12c. Attenuation vs Input Power (Frequency = 26 GHz)

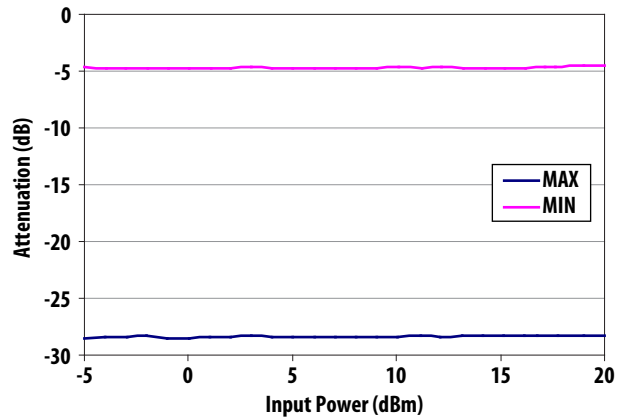

Figure 12d. Attenuation vs Input Power (Frequency = 40GHz)

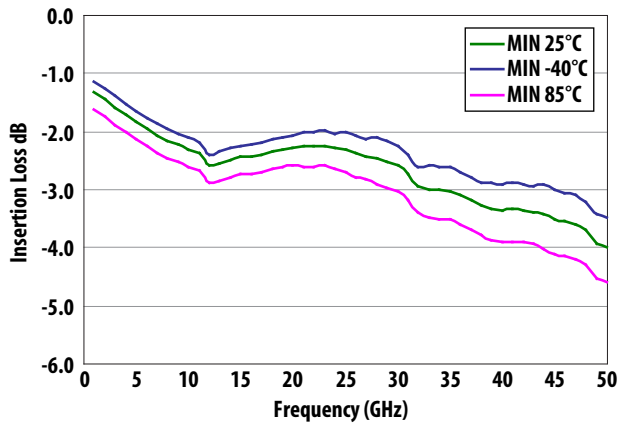

Figure 13. Minimum Attenuation vs Frequency (Over Temp)

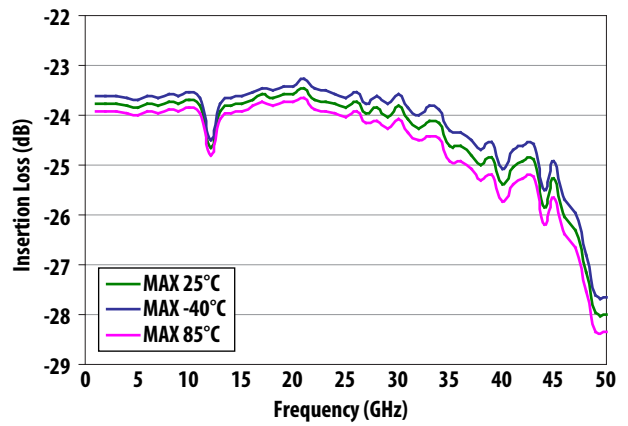

Figure 14. Maximum Attenuation vs Frequency (Over Temp)

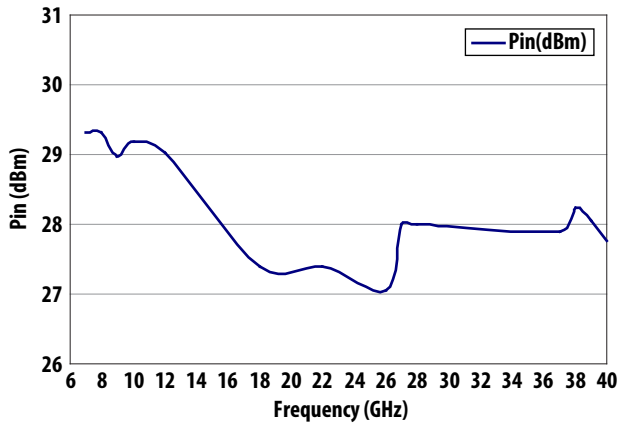

Figure 15. Minimum Attenuation vs Input P1dB

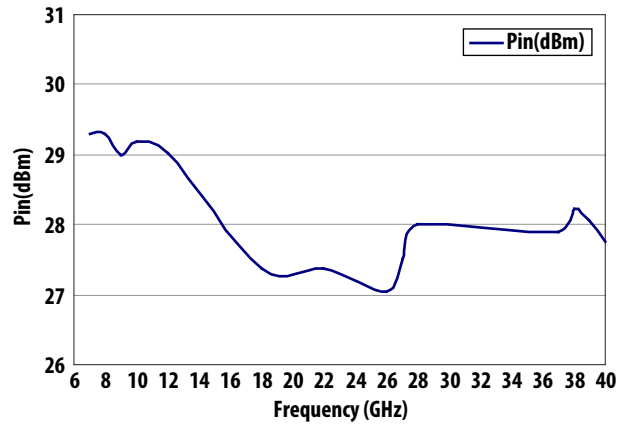

Figure 16. Mid (10dB) Attenuation vs Input P1dB

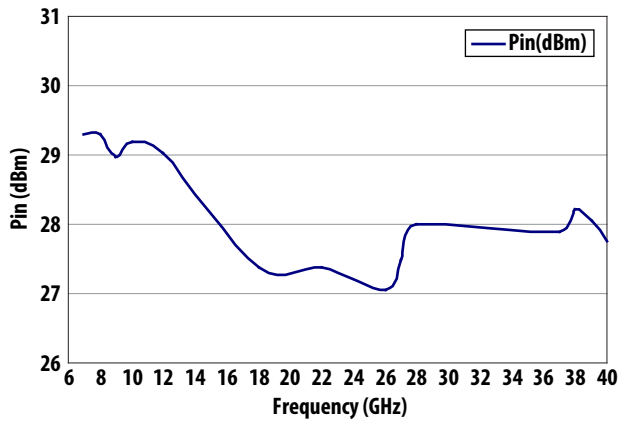

Figure 17. Maximum Attenuation vs Input P1dB

**AMMC-6640 Typical Scattering Parameters at Min Attenuation ( $T_c = 25^\circ\text{C}$ ,  $Z_0 = 50\text{ohm}$ ,  $V_{Sh} = 0\text{V}$ ,  $V_{Ser} = 1.2\text{V}$ )**

Freq GHz	S11			S21			S12			S22		
	dB	Mag	Ang	dB	Mag	Ang	dB	Mag	Ang	dB	Mag	Ang
1	-20.6	0.0932	-39.701	-1.3	0.8577	-9.722	-1.3	0.857	-9.794	-20.6	0.0931	-40.019
2	-19.0	0.1125	-67.029	-1.5	0.8462	-18.338	-1.5	0.8449	-18.430	-19.1	0.1112	-67.431
3	-17.5	0.1329	-86.619	-1.6	0.833	-26.672	-1.6	0.8313	-26.790	-17.6	0.132	-87.343
4	-16.2	0.1547	-102.289	-1.7	0.8207	-34.857	-1.7	0.8202	-34.940	-16.2	0.1551	-102.965
5	-15.1	0.1754	-114.732	-1.8	0.8087	-42.783	-1.9	0.8076	-42.819	-15.2	0.1742	-115.708
6	-14.3	0.1933	-126.006	-2.0	0.7982	-50.532	-2.0	0.7972	-50.551	-14.3	0.1933	-127.172
7	-13.6	0.2080	-135.886	-2.1	0.7888	-58.203	-2.1	0.7883	-58.308	-13.7	0.207	-137.300
8	-13.2	0.2189	-145.523	-2.1	0.7809	-65.878	-2.2	0.7803	-65.937	-13.1	0.2203	-147.338
9	-12.9	0.2274	-154.544	-2.2	0.7738	-73.421	-2.2	0.7721	-73.455	-12.9	0.2274	-156.155
10	-12.7	0.2308	-163.071	-2.3	0.7671	-81.038	-2.3	0.766	-80.994	-12.7	0.2307	-165.479
11	-12.8	0.2281	-170.663	-2.4	0.7601	-88.661	-2.4	0.761	-88.626	-12.9	0.2276	-173.700
12	-12.9	0.2273	-175.121	-2.6	0.7425	-96.400	-2.6	0.7425	-96.502	-13.2	0.2188	-178.184
13	-12.4	0.2401	173.936	-2.5	0.7458	-102.159	-2.6	0.7444	-102.261	-12.5	0.2368	172.131
14	-12.8	0.2293	164.435	-2.5	0.7514	-109.760	-2.5	0.7489	-109.761	-12.9	0.2269	162.000
15	-13.3	0.2169	155.170	-2.4	0.7552	-117.353	-2.5	0.7533	-117.251	-13.3	0.2175	151.783
16	-13.8	0.2040	146.732	-2.4	0.7561	-124.966	-2.4	0.7543	-124.928	-13.9	0.2022	143.011
17	-14.8	0.1826	136.275	-2.4	0.7591	-132.406	-2.4	0.7581	-132.468	-14.6	0.1863	132.323
18	-15.7	0.1643	125.779	-2.3	0.7638	-140.286	-2.4	0.7625	-140.279	-15.6	0.1657	122.267
19	-16.8	0.1439	116.550	-2.3	0.7668	-148.222	-2.3	0.7654	-148.207	-16.6	0.148	110.142
20	-18.3	0.1215	103.867	-2.3	0.7692	-156.276	-2.3	0.7687	-156.225	-18.0	0.1259	98.295
21	-20.2	0.0977	89.857	-2.2	0.7718	-164.428	-2.3	0.7716	-164.400	-19.4	0.1077	83.106
22	-21.7	0.0824	74.397	-2.2	0.7721	-172.624	-2.3	0.7711	-172.635	-20.8	0.0908	65.142
23	-23.9	0.0636	54.106	-2.2	0.7725	179.092	-2.3	0.7716	179.116	-22.1	0.0787	46.719
24	-25.3	0.0543	27.765	-2.3	0.769	170.719	-2.3	0.7686	170.744	-22.9	0.0713	19.344
25	-24.8	0.0578	-10.727	-2.3	0.7664	162.460	-2.3	0.7659	162.428	-22.7	0.0731	-10.712
26	-23.4	0.0674	-34.439	-2.4	0.7601	154.169	-2.4	0.7595	154.207	-21.2	0.0871	-35.577
27	-22.1	0.0788	-57.191	-2.4	0.756	146.174	-2.4	0.7552	146.169	-20.9	0.0905	-59.580
28	-20.4	0.0950	-76.429	-2.5	0.7534	137.880	-2.5	0.7535	137.853	-19.9	0.1014	-80.375
29	-19.9	0.1017	-84.707	-2.5	0.7478	129.613	-2.5	0.7467	129.541	-19.3	0.1079	-93.340
30	-19.5	0.1059	-94.597	-2.6	0.7421	121.074	-2.6	0.74	121.118	-19.3	0.1078	-102.213
31	-18.3	0.1217	-99.925	-2.7	0.7292	112.595	-2.8	0.7275	112.662	-18.9	0.1129	-113.489
32	-17.0	0.1412	-108.513	-3.0	0.7119	104.883	-3.0	0.7108	104.950	-19.3	0.1084	-119.616
33	-16.8	0.1451	-120.725	-3.0	0.7089	97.839	-3.0	0.7089	97.727	-18.5	0.1188	-129.955
34	-16.9	0.1421	-135.108	-3.0	0.7076	89.978	-3.0	0.7068	89.951	-19.6	0.1049	-140.476
35	-17.5	0.1334	-143.267	-3.0	0.7065	81.829	-3.0	0.7043	81.862	-20.4	0.0958	-152.186
36	-18.4	0.1199	-155.855	-3.1	0.6996	73.527	-3.1	0.6995	73.650	-22.1	0.0784	-158.477
37	-21.0	0.0894	-165.255	-3.2	0.693	65.487	-3.2	0.6925	65.483	-24.0	0.0633	-163.890
38	-22.3	0.0768	-168.127	-3.3	0.6856	57.571	-3.3	0.684	57.727	-28.2	0.039	179.216
39	-27.7	0.0410	-170.951	-3.3	0.6814	50.066	-3.4	0.6796	49.976	-35.0	0.0177	-159.042
40	-29.8	0.0322	-123.140	-3.4	0.6797	42.263	-3.4	0.6787	42.305	-40.0	0.01	-91.572
41	-32.6	0.0234	-94.952	-3.3	0.6805	34.150	-3.4	0.6795	34.252	-28.2	0.0391	-49.532
42	-24.6	0.0586	-82.680	-3.3	0.6801	25.860	-3.4	0.6791	25.858	-25.1	0.0559	-49.962
43	-23.0	0.0709	-82.607	-3.4	0.6772	17.413	-3.4	0.677	17.511	-22.0	0.079	-53.604
44	-22.7	0.0733	-89.192	-3.4	0.6747	8.839	-3.4	0.6733	8.959	-21.2	0.0868	-55.883
45	-21.0	0.0891	-87.119	-3.5	0.6685	0.343	-3.5	0.6682	0.327	-18.9	0.1131	-59.833
46	-20.7	0.0920	-92.026	-3.5	0.6647	-8.155	-3.6	0.6631	-8.162	-18.5	0.1182	-66.653
47	-21.5	0.0846	-97.232	-3.6	0.6604	-16.940	-3.6	0.6593	-16.712	-17.4	0.1347	-73.712
48	-19.4	0.1073	-81.170	-3.7	0.6528	-25.506	-3.7	0.6532	-25.465	-16.6	0.1485	-76.486
49	-19.8	0.1024	-94.833	-3.9	0.6371	-34.353	-4.0	0.6344	-34.428	-17.1	0.1391	-81.478
50	-20.8	0.0917	-76.090	-4.0	0.6323	-42.814	-4.0	0.6323	-42.706	-17.7	0.1301	-84.462

Note : S-parameters are obtained from on-wafer measurements.



**AMMC-6640 Typical Scattering Parameters<sup>[1]</sup> at Max Attenuation (Tc = 25°C, Zo = 50ohm, Vsh = 1.2V, Vser = 0V)**

Freq GHz	S11			S21			S12			S22		
	dB	Mag	Phase	dB	Mag	Phase	dB	Mag	Phase	dB	Mag	Phase
1	-22.7	0.0729	-5.5258	-25.7	0.0521	-7.5828	-25.6	0.0522	-7.4292	-22.5	0.0747	-6.1766
2	-22.3	0.0768	-13.2247	-25.7	0.0518	-14.6637	-25.7	0.0519	-14.5345	-22.4	0.0755	-12.2651
3	-22.2	0.0772	-16.9325	-25.7	0.0516	-21.5768	-25.7	0.0516	-21.4979	-22.3	0.0765	-18.4452
4	-22.2	0.0779	-21.5934	-25.8	0.0515	-28.5692	-25.7	0.0516	-28.4928	-22.2	0.0775	-23.3754
5	-22.1	0.0786	-33.3894	-25.8	0.0514	-35.5800	-25.8	0.0515	-35.4740	-21.9	0.0803	-30.7458
6	-21.2	0.0872	-31.5010	-25.8	0.0514	-42.5283	-25.8	0.0515	-42.4061	-21.8	0.0812	-34.2677
7	-22.8	0.0728	-44.0887	-25.8	0.0514	-49.6884	-25.8	0.0515	-49.5645	-21.6	0.0829	-40.4200
8	-19.6	0.1045	-42.6800	-25.8	0.0512	-56.9097	-25.8	0.0514	-56.8600	-21.4	0.0854	-44.2241
9	-24.3	0.0609	-36.7905	-25.8	0.0511	-63.8186	-25.8	0.0512	-63.7487	-21.1	0.0880	-49.4219
10	-19.7	0.1031	-65.2203	-25.7	0.0516	-70.8964	-25.7	0.0517	-70.8126	-20.8	0.0911	-52.1457
11	-20.6	0.0936	-35.3753	-25.7	0.0517	-79.1980	-25.7	0.0519	-79.1085	-20.5	0.0949	-52.2774
12	-20.5	0.0949	-71.0060	-26.6	0.0466	-86.4665	-26.6	0.0466	-86.4224	-20.3	0.0967	-60.7138
13	-19.9	0.1015	-58.7446	-26.1	0.0496	-89.7200	-26.1	0.0496	-89.7333	-20.0	0.1000	-63.3773
14	-20.2	0.0981	-76.2918	-25.9	0.0508	-97.5292	-25.9	0.0508	-97.5323	-20.1	0.0994	-69.2780
15	-19.8	0.1028	-67.2713	-25.8	0.0511	-105.3019	-25.8	0.0512	-105.2839	-19.8	0.1028	-70.2240
16	-19.3	0.1080	-83.1103	-25.8	0.0510	-112.5329	-25.8	0.0511	-112.5971	-19.4	0.1071	-74.8813
17	-20.4	0.0952	-72.5337	-25.8	0.0513	-119.9556	-25.8	0.0513	-119.9577	-19.8	0.1018	-75.0772
18	-20.1	0.0985	-86.9053	-25.8	0.0514	-127.5867	-25.8	0.0515	-127.4968	-19.7	0.1031	-77.9186
19	-20.6	0.0931	-85.0594	-25.7	0.0516	-134.9971	-25.7	0.0516	-134.8987	-20.2	0.0980	-84.3073
20	-19.5	0.1058	-85.8985	-25.7	0.0518	-142.9097	-25.7	0.0519	-142.8997	-19.3	0.1080	-80.9405
21	-20.4	0.0958	-75.9215	-25.7	0.0517	-150.2916	-25.7	0.0517	-150.3905	-19.9	0.1009	-80.9279
22	-19.5	0.1057	-89.6834	-25.8	0.0514	-158.4518	-25.8	0.0514	-158.3550	-19.4	0.1067	-83.4067
23	-19.6	0.1041	-93.8877	-25.8	0.0512	-165.6865	-25.8	0.0513	-165.6755	-18.6	0.1169	-88.1148
24	-17.6	0.1320	-92.9899	-25.8	0.0515	-173.0357	-25.8	0.0515	-173.0839	-18.8	0.1154	-84.0382
25	-20.0	0.0997	-91.0652	-25.8	0.0513	178.8482	-25.8	0.0513	178.9105	-19.5	0.1062	-83.8869
26	-21.4	0.0851	-95.9689	-25.9	0.0509	170.8062	-25.9	0.0509	170.8189	-20.2	0.0972	-89.0806
27	-20.2	0.0977	-100.1239	-25.9	0.0505	163.5284	-25.9	0.0505	163.3861	-19.1	0.1115	-86.7655
28	-20.5	0.0939	-89.8294	-26.0	0.0504	156.0409	-26.0	0.0504	155.9306	-20.3	0.0970	-75.9203
29	-21.2	0.0871	-91.4041	-26.0	0.0503	147.8155	-25.9	0.0504	147.8736	-20.2	0.0979	-76.7284
30	-21.0	0.0891	-96.1312	-25.9	0.0505	140.1722	-25.9	0.0505	140.0757	-19.5	0.1063	-84.3845
31	-19.6	0.1047	-85.0162	-26.1	0.0498	132.9230	-26.1	0.0497	132.7575	-18.7	0.1158	-72.8688
32	-18.6	0.1178	-90.3504	-26.0	0.0502	124.6842	-26.0	0.0501	124.7602	-17.2	0.1376	-78.7503
33	-24.2	0.0616	-89.6214	-26.1	0.0498	116.5344	-26.0	0.0500	116.4108	-20.6	0.0930	-78.2454
34	-20.2	0.0983	-84.3340	-26.1	0.0494	108.1947	-26.1	0.0494	107.9625	-18.0	0.1254	-71.6425
35	-21.3	0.0860	-76.1681	-26.3	0.0484	99.7143	-26.3	0.0485	99.2199	-18.4	0.1209	-76.2152
36	-19.2	0.1092	-73.0004	-26.5	0.0474	91.4310	-26.4	0.0476	91.8154	-18.3	0.1223	-62.4551
37	-21.4	0.0847	-79.7086	-26.6	0.0465	83.8384	-26.7	0.0462	85.3637	-18.0	0.1255	-66.6917
38	-16.8	0.1442	-59.9234	-26.8	0.0458	76.6048	-26.9	0.0452	78.3842	-16.7	0.1465	-62.2860
39	-17.3	0.1369	-74.3234	-26.7	0.0462	71.4124	-26.8	0.0456	70.9578	-15.3	0.1726	-59.2514
40	-16.5	0.1488	-65.9638	-26.8	0.0458	64.2460	-26.7	0.0461	63.5662	-15.7	0.1639	-56.2098
41	-16.2	0.1548	-81.6781	-26.7	0.0460	55.9474	-26.7	0.0464	56.2569	-14.2	0.1949	-64.7675
42	-17.3	0.1372	-58.2245	-26.5	0.0473	47.5980	-26.6	0.0467	47.7866	-15.4	0.1702	-58.3368
43	-14.7	0.1844	-69.1859	-26.7	0.0463	38.3880	-26.7	0.0463	37.9395	-13.1	0.2210	-57.9735
44	-15.5	0.1677	-71.3908	-26.8	0.0459	29.2405	-26.7	0.0460	29.0382	-13.0	0.2243	-68.5748
45	-14.5	0.1882	-62.4269	-26.8	0.0458	20.5805	-26.8	0.0457	20.3836	-13.5	0.2119	-53.4927
46	-14.3	0.1932	-71.4140	-27.1	0.0441	12.2736	-27.1	0.0443	10.9667	-10.9	0.2852	-68.8740
47	-12.3	0.2421	-65.2403	-27.8	0.0408	3.3789	-27.8	0.0409	2.4698	-11.7	0.2600	-55.1522
48	-13.7	0.2057	-73.1761	-27.8	0.0408	-5.2377	-27.8	0.0405	-6.0150	-10.3	0.3067	-63.1535
49	-12.2	0.2445	-54.5568	-27.5	0.0422	-14.4113	-27.6	0.0417	-16.3065	-10.6	0.2960	-60.3155
50	-11.0	0.2813	-77.9185	-28.6	0.0371	-23.5788	-28.8	0.0364	-27.4289	-8.0	0.3965	-71.1613

Note : S-parameters are obtained from on-wafer measurements.

## AMMC-6640 Bias and Usage

The AMMC-6640 attenuator is driven by voltage ramps placed on  $V_{series}$  and  $V_{shunt}$  control pins. Operation in this mode requires voltages between 0 to 1.5 volts for  $V_{se}$  and 0 to 1.5 volts for  $V_{sh}$ . The recommended DC control voltage range is  $V_{se} = 0$  to 1.2 volts and  $V_{sh} = 0$  to 1.2 volts. The simplified schematic for the MMIC die is shown in Figure 19.

In the minimum attenuation state, the series FETs are fully biased at 1.2 volts and the shunt FETs are in the full "off" state at 0 volts. Inversely, for a maximum attenuation state, the series FETs are "off" at 0 volts bias and the shunt FETs are fully on at 1.2 volts. Achieving attenuation levels in-between these two states requires voltage levels similar to those in Table 4. Applying voltage to the shunt FETs sets the source to drain resistance and establishes the main attenuation level. The match is optimized by the amount of bias applied to the series FETs. The match will determine how flat the attenuation level is across a broadband operational range.

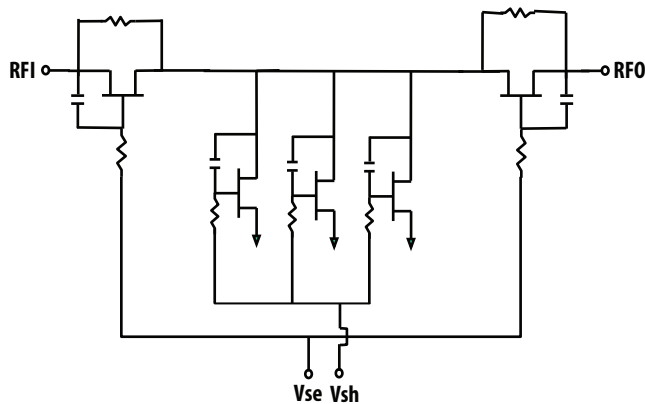

Figure 18. AMMC-6640 Schematic

Table 4. AMMC-6640 Typical Control Voltages

Attenuation (dB)	$V_{series}$ (V)	$V_{shunt}$ (V)
0	1.2	0
2	0.440	0.325
4	0.435	0.383
6	0.430	0.416
8	0.420	0.440
10	0.410	0.465
12	0.400	0.480
14	0.385	0.505
16	0.375	0.535
18	0.360	0.575
20	0.350	0.650
22	0.346	0.845
max	0	1.2

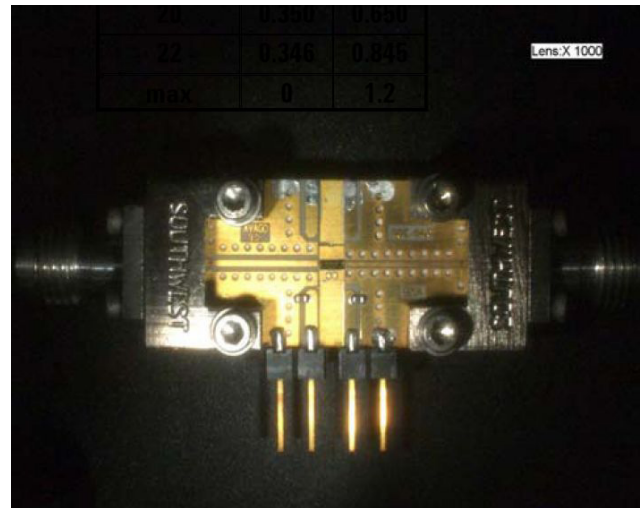

Figure 19. Demonstration Board (available upon request)

## AMMC-6640 Assembly Techniques

The backside of the MMIC chip is RF ground. For microstrip applications the chip should be attached directly to the ground plane (e.g. circuit carrier or heatsink) using electrically conductive epoxy [1].

For best performance, the topside of the MMIC should be brought up to the same height as the circuit surrounding it. This can be accomplished by mounting a gold plated metal shim (same length as the MMIC) under the chip which is of correct thickness to make the chip and adjacent circuit the same height. The amount of epoxy used for the chip or shim attachment should be just enough to provide a thin fillet around the bottom perimeter of the chip. The ground plane should be free of any residue that may jeopardize electrical or mechanical attachment.

RF connections should be kept as short as reasonable to minimize performance degradation due to undesirable series inductance. A single bond wire is normally

sufficient for signal connections, however double bonding with 0.7mil gold wire will reduce series inductance. Gold thermo-sonic wedge bonding is the preferred method for wire attachment to the bond pads. The recommended wire bond stage temperature is 150°C+/-2°C. Caution should be taken to not exceed the Absolute Maximum Rating for assembly temperature and time.

The chip is 100µm thick and should be handled with care. Even though this MMIC has 4550 Angstroms of silicon nitride covering the air bridges on the top surface of the die, it should be handled by the edges or with a custom collet (do not pick up the die with a vacuum on die center). Bonding pads and chip backside metallization are gold.

**This MMIC is static sensitive and ESD precautions should be taken. Please see page 1 for ESD rating levels.**

Notes:

1. Sumitomo 1295SA silver epoxy is recommended.

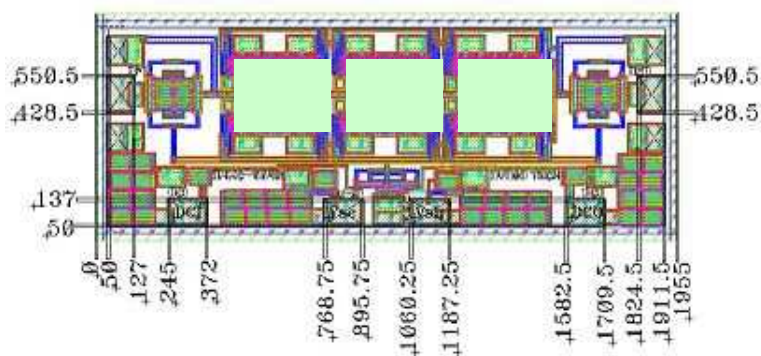

Figure 20. AMMC-6640 Bond Pad Locations

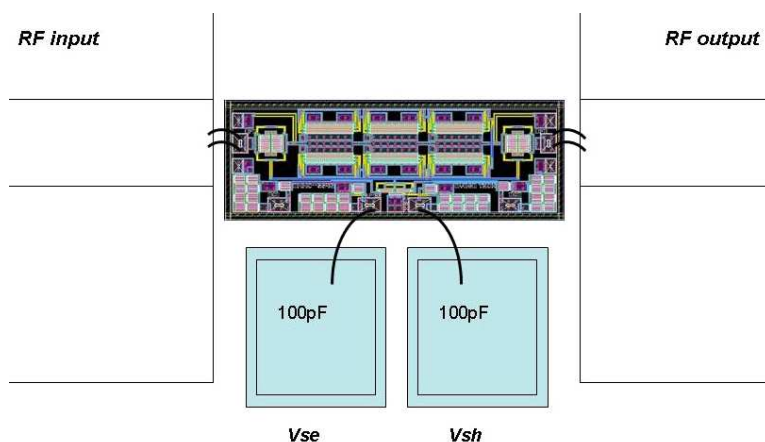

Figure 21. AMMC-6640 Assembly Diagram

For product information and a complete list of distributors, please go to our web site: [www.avagotech.com](http://www.avagotech.com)

Avago, Avago Technologies, and the A logo are trademarks of Avago Technologies in the United States and other countries. Data subject to change. Copyright © 2005-2014 Avago Technologies. All rights reserved. AV02-2237EN - October 29, 2014

**AVAGO**  
TECHNOLOGIES