



Chipsmall Limited consists of a professional team with an average of over 10 year of expertise in the distribution of electronic components. Based in Hongkong, we have already established firm and mutual-benefit business relationships with customers from,Europe,America and south Asia,supplying obsolete and hard-to-find components to meet their specific needs.

With the principle of "Quality Parts,Customers Priority,Honest Operation,and Considerate Service",our business mainly focus on the distribution of electronic components. Line cards we deal with include Microchip,ALPS,ROHM,Xilinx,Pulse,ON,Everlight and Freescale. Main products comprise IC,Modules,Potentiometer,IC Socket,Relay,Connector.Our parts cover such applications as commercial,industrial, and automotives areas.

We are looking forward to setting up business relationship with you and hope to provide you with the best service and solution. Let us make a better world for our industry!



Contact us

Tel: +86-755-8981 8866 Fax: +86-755-8427 6832

Email & Skype: info@chipsmall.com Web: www.chipsmall.com

Address: A1208, Overseas Decoration Building, #122 Zhenhua RD., Futian, Shenzhen, China



AMMP-6640

DC-40 GHz Variable Attenuator



Data Sheet

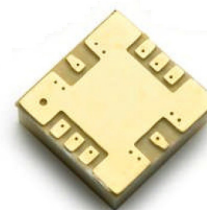

Description

The AMMP-6640 MMIC is a monolithic, voltage variable, GaAs IC attenuator that operates from DC-40 GHz. It is fabricated using Avago Technologies enhancement mode MMIC process with backside ground vias, and gate lengths of approximately 0.25um. The attenuator has a distributed topology that helps to absorb parasitic effects of its series and shunt FETs to make it broadband.

Package Diagram

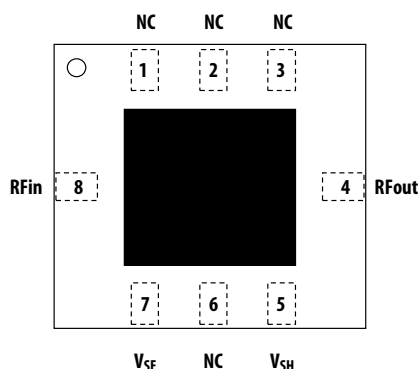

Features

- Surface Mount Package, 5.0 x 5.0 x 2 mm
- Wide Frequency Range : DC-40 GHz
- I.L. : 5dB @ 40GHz
- Attenuation Range : >20dB
- IIP3 : >25dBm
- P1dB : >26dBm
- Dual Positive Bias Supply

Applications

- Microwave Radio Systems
- Satellite VSAT, DBS Up / Down Link
- LMDS & Pt – Pt mmW Long Haul
- Broadband Wireless Access (including 802.16 and 802.20 WiMax)
- WLL and MMDS loops

Functional Block Diagram

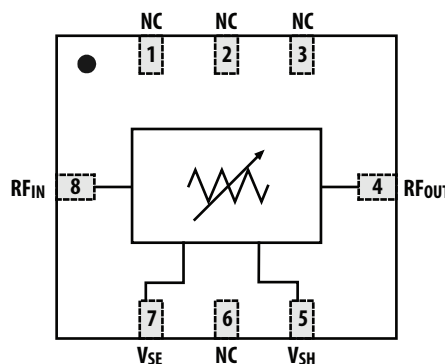

Pin	Function
1	NC
2	NC
3	NC
4	RF _{OUT}
5	V _{SH}
6	NC
7	V _{SE}
8	RF _{IN}

Top View

Package Base: GND



Attention: Observe Precautions for handling electrostatic sensitive devices.
 ESD Machine Model (Class A): 70V
 ESD Human Body Model (Class 1A): 350V
 Refer to Avago Application Note A004R: Electrostatic Discharge Damage and Control.

Note: MSL Rating = Level 2A

Electrical Specifications

1. Small/Large -signal data measured in a fully de-embedded test fixture form TA = 25°C.
2. Data obtained from on-wafer measurement
3. This final package part performance is verified by a functional test correlated to actual performance at one or more frequencies.
4. Specifications are derived from measurements in a 50 Ω test environment. Aspects of the amplifier performance may be improved over a more narrow bandwidth by application of additional conjugate, linearity, or low noise (Гopt) matching.

Table 1. RF Electrical Characteristics [1,2]

Small signal data measured in packaged form on a 2.4mm connector based evaluation board at T_A = 25°C, Z_o = 50Ω

Symbol	Parameters and Test Conditions	Units	Freq. [GHz]	Minimum	Typical	Maximum
Minimum Attenuation (Reference State)	Small-signal S21 V _{se} = 1.2 V, Vsh = 0	dB	6		2.5	3.1
			28		3.8	4.5
			26		4	4.6
			30		4.4	5
			40		5	6
Maximum Attenuation	Small-signal S21 V _{se} = 0 V, Vsh = 1.2V	dB	6	23	25	
			18	23	26	
			26	23	26	
			38	23	26	
			40	25	28	
RL _{in} and RL _{out}	At Minimum Attenuation V _{se} = 1.2V, Vsh = 0V	dB	<40		10	
RL _{in} and RL _{out}	At Maximum Attenuation V _{se} = 0V, Vsh = 1.2V	dB	<40		9	
IIP3	at Minimum Attenuation	dBm	<38		30	
P1dB (input)	at Minimum Attenuation	dBm	<40		27	
P1dB (input)	at Maximum Attenuation	dBm	<40		27	

Table 2. Recommended Operating Range

1. Ambient operational temperature TA = 25°C unless otherwise noted.
2. Data obtained from on-wafer measurement

Parameter	Min.	Typical	Max.	Unit	Test Condition
Vse Control Current (Min Attenuation), I _{c_Vse}			10.0	uA	Vse=1.2V, Vsh=0
Vse Control Current (Max Attenuation), I _{c_Vse}			1.5	mA	Vse=0V, Vsh=1.2V
Vsh Control Current (Min Attenuation), I _{c_Vsh}			10.0	uA	Vse=0V, Vsh=1.2V
Vsh Control Current (Max Attenuation), I _{c_Vsh}			1.5	mA	Vse=1.2V, Vsh=0

Table 3. Absolute Minimum and Maximum Ratings [1]

Parameter	Min.	Max.	Unit	Comments
Voltage to Control VSWR, V _C	0	2.5	V	
RF Input Power, P _{in}		30	dBm	
Operating Channel Temperature, T _{ch}		+150	°C	
Storage Temperature, T _{stg}	-40	+150	°C	
Maximum Assembly Temperature, T _{max}		260	°C	60 second maximum

Notes:

1. Operation in excess of any one of these conditions may result in permanent damage to this device. The absolute maximum ratings for V_C and P_{in} were determined at an ambient temperature of 25°C unless noted otherwise..

AMMP-6640 Typical Performance ($T_A = 25^\circ\text{C}$, $Z_{in} = Z_{out} = 50 \Omega$)

(Data was obtained from a 2.4mm connector based test fixture and includes connector and board mismatch and losses. Losses may gradually increase from ~0.1dB at 45MHz to ~1.5dB at 40GHz at input and output ports.)

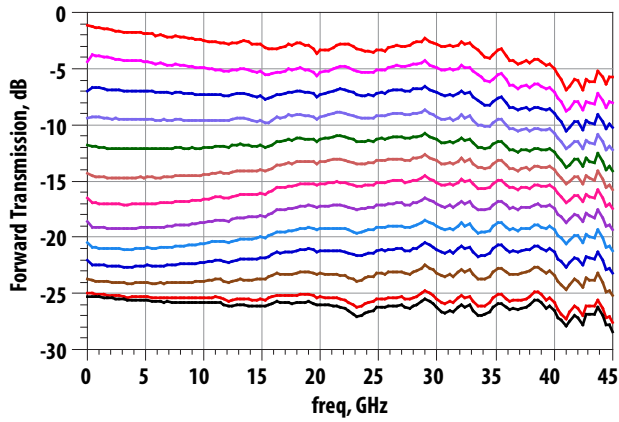

Attenuation (dB)	Vseries (V)	Vshunt (V)
0	1.2	0
2	0.440	0.325
4	0.435	0.383
6	0.430	0.416
8	0.420	0.440
10	0.410	0.465
12	0.400	0.480
14	0.385	0.505
16	0.375	0.535
18	0.360	0.575
20	0.350	0.650
22	0.346	0.845
max	0	1.2

Figure 9. Attenuation vs Frequency

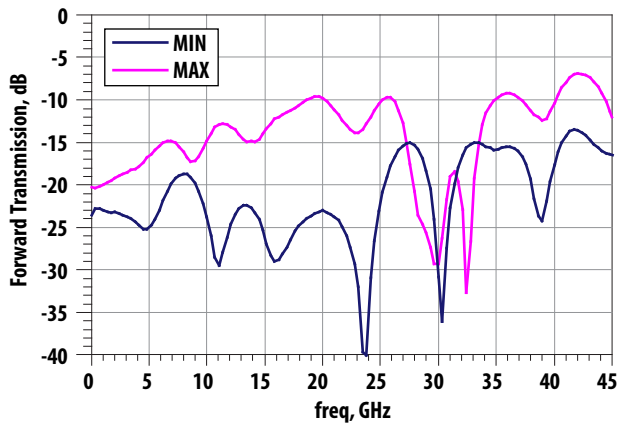

Figure 10a. S11 vs Frequency

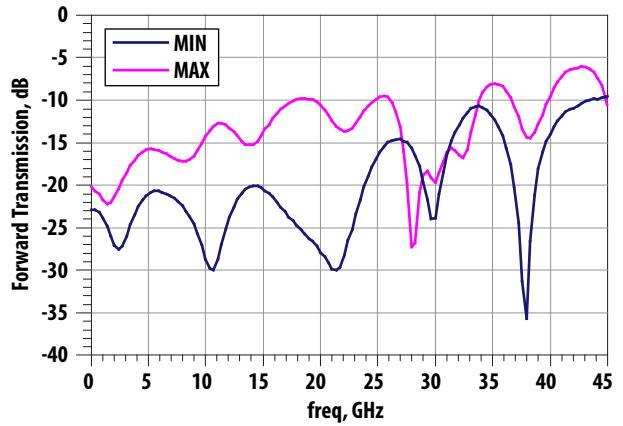

Figure 10b. S22 vs Frequency

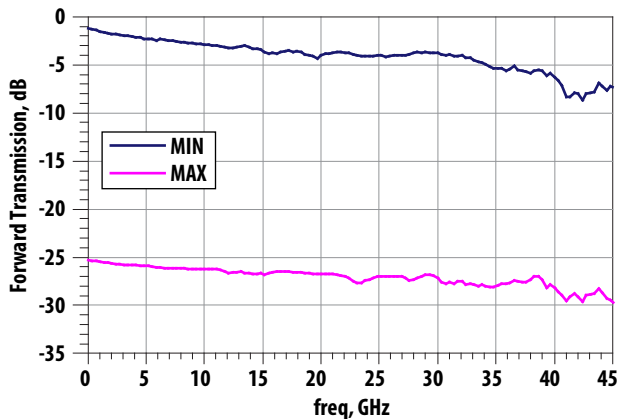

Figure 11. Insertion Loss vs Frequency

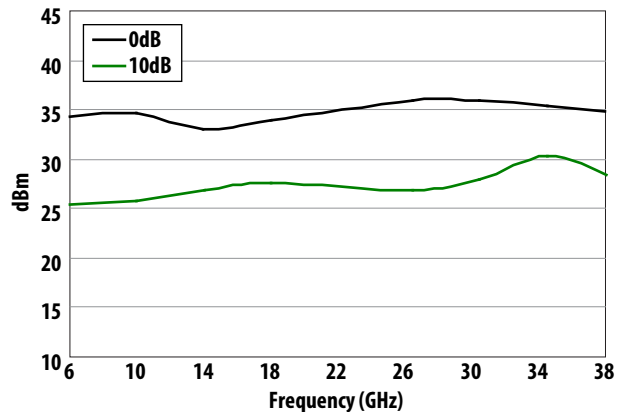

Figure 12. IIP3 vs Attenuation Input Power = 0dBm

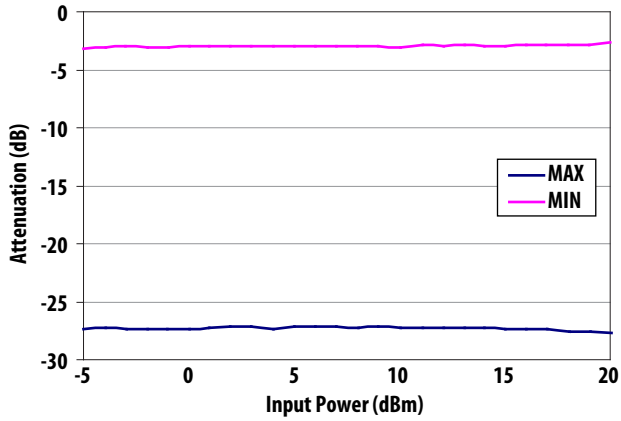

Figure 13a. Attenuation vs Input Power (Frequency = 6 GHz)

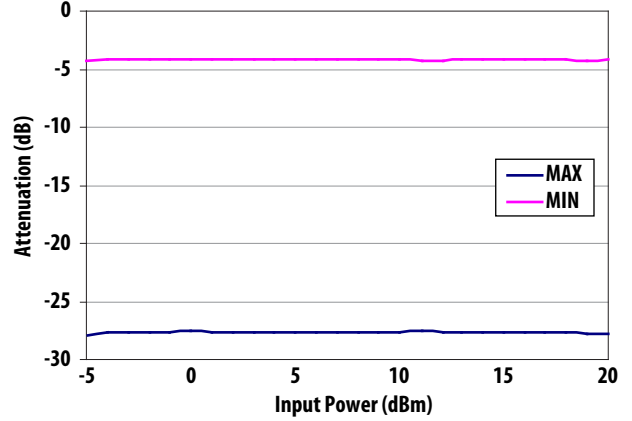

Figure 13b. Attenuation vs Input Power (Frequency = 18 GHz)

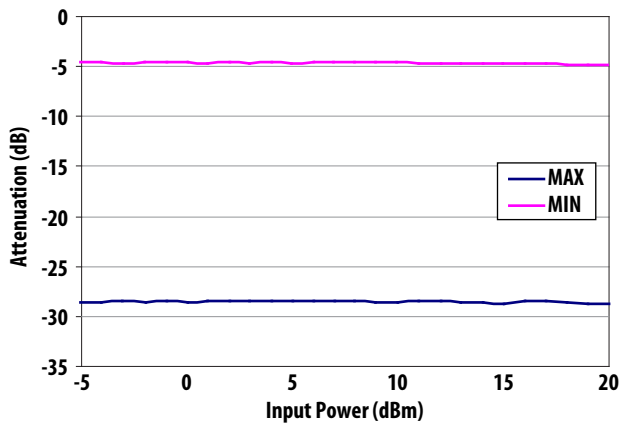

Figure 13c. Attenuation vs Input Power (Frequency = 26 GHz)

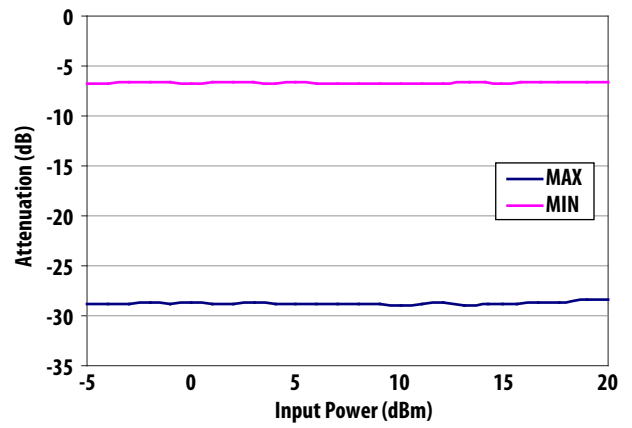

Figure 13d. Attenuation vs Input Power (Frequency = 40 GHz)

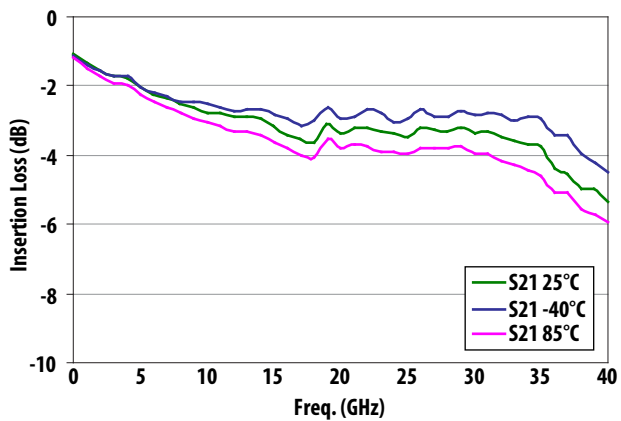

Figure 14. Minimum Attenuation vs Frequency (Over Temp)

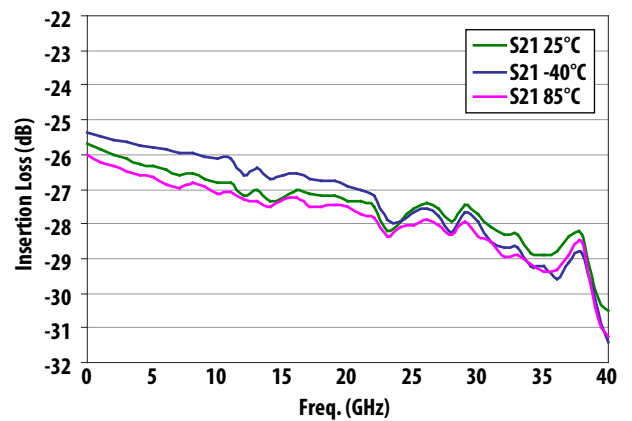

Figure 15. Maximum Attenuation vs Frequency (Over Temp)

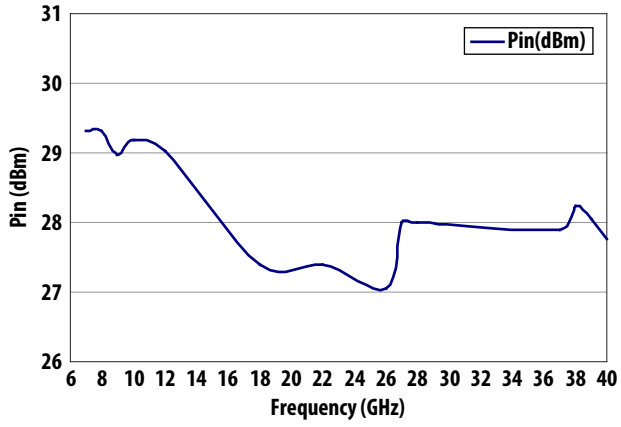

Figure 16a. Minimum Attenuation vs P1dB

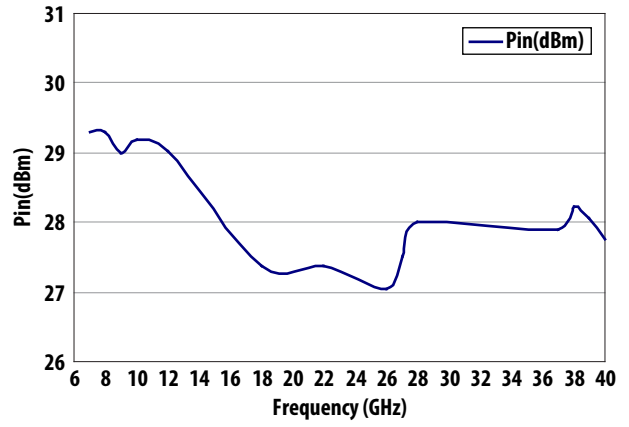

Figure 16b. Mid (10dB) Attenuation vs P1dB

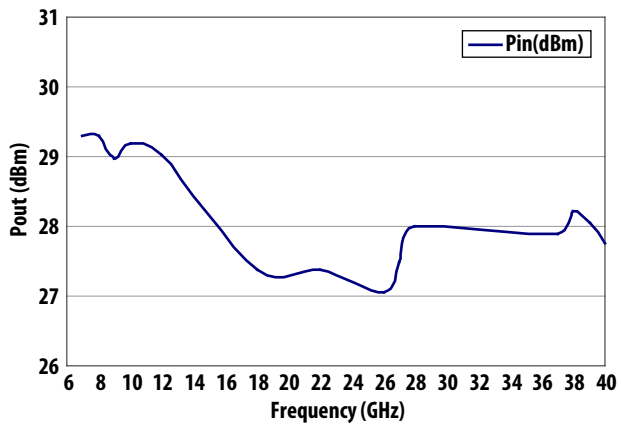

Figure 16c. Maximum Attenuation vs P1dB

AMMP-6640 Typical Scattering Parameters at Min Attenuation (Tc = 25°C, Zo = 50ohm, Vsh = 0V, Vser = 1.2V)

Freq GHZ	S11			S21			S12			S22		
	dB	Mag	Ang	dB	Mag	Ang	dB	Mag	Ang	dB	Mag	Ang
0.045	-20.59	0.093	-6.109	-1.16	0.875	-3.757	-1.14	0.877	-3.707	-20.54	0.094	-6.114
1	-20.96	0.090	-112.848	-1.44	0.847	-75.611	-1.45	0.847	-75.587	-20.17	0.098	-110.547
2	-20.90	0.090	130.830	-1.66	0.826	-146.464	-1.68	0.824	-146.562	-20.33	0.096	138.122
3	-18.61	0.117	35.049	-1.82	0.811	143.316	-1.85	0.808	143.109	-19.79	0.103	29.570
4	-16.62	0.148	-45.942	-1.87	0.806	73.784	-1.93	0.801	74.044	-18.17	0.123	-69.257
5	-16.05	0.158	-129.196	-2.14	0.781	3.785	-2.12	0.784	3.979	-16.99	0.141	-152.676
6	-16.98	0.142	138.700	-2.34	0.764	-66.474	-2.28	0.769	-66.953	-16.40	0.151	129.888
7	-17.65	0.131	36.607	-2.44	0.755	-136.326	-2.27	0.770	-136.603	-16.54	0.149	49.572
8	-16.43	0.151	-57.173	-2.61	0.741	152.645	-2.45	0.754	153.388	-16.78	0.145	-46.837
9	-14.56	0.187	-138.881	-2.70	0.733	82.456	-2.70	0.733	83.198	-15.35	0.171	-154.053
10	-13.06	0.222	143.918	-2.87	0.718	12.539	-2.93	0.714	13.560	-13.27	0.217	108.988
11	-12.46	0.238	64.302	-3.01	0.707	-56.032	-3.03	0.705	-55.954	-12.43	0.239	24.851
12	-12.94	0.225	-23.301	-3.11	0.699	-126.138	-3.08	0.701	-125.997	-12.59	0.235	-53.211
13	-13.89	0.202	-121.617	-3.11	0.699	164.687	-3.11	0.699	164.986	-13.08	0.222	-132.294
14	-13.65	0.208	137.590	-3.13	0.698	92.879	-3.08	0.701	94.416	-13.53	0.211	136.844
15	-13.08	0.222	55.976	-3.36	0.679	23.408	-3.34	0.681	23.275	-13.59	0.209	46.527
16	-11.20	0.276	-18.547	-3.61	0.660	-45.467	-3.66	0.656	-45.977	-12.08	0.249	-43.928
17	-10.59	0.295	-98.833	-3.71	0.652	-118.450	-3.72	0.652	-117.040	-10.51	0.298	-132.859
18	-10.90	0.285	172.391	-3.81	0.645	173.551	-3.93	0.636	171.219	-10.04	0.315	143.325
19	-11.46	0.267	78.681	-3.31	0.684	106.275	-3.67	0.655	104.989	-10.57	0.296	61.870
20	-12.10	0.248	-9.746	-3.56	0.664	34.416	-3.19	0.692	33.917	-11.52	0.265	-20.744
21	-12.61	0.234	-93.291	-3.59	0.661	-37.429	-3.41	0.675	-37.593	-12.01	0.251	-103.746
22	-13.37	0.215	176.125	-3.59	0.662	-109.595	-3.63	0.658	-108.734	-12.45	0.239	175.710
23	-14.68	0.185	76.530	-3.74	0.650	179.527	-3.73	0.651	179.715	-14.52	0.188	92.966
24	-13.40	0.214	-15.549	-3.77	0.648	109.037	-3.68	0.654	109.049	-15.19	0.174	-7.986
25	-11.14	0.277	-89.351	-3.88	0.640	37.445	-3.89	0.639	37.299	-12.06	0.250	-109.538
26	-10.46	0.300	-160.003	-3.66	0.657	-34.248	-3.76	0.649	-33.335	-10.33	0.305	170.911
27	-13.95	0.201	122.286	-3.69	0.654	-105.017	-3.63	0.659	-103.780	-12.67	0.233	104.844
28	-26.96	0.045	-7.455	-3.74	0.650	-177.405	-3.62	0.659	-177.323	-18.31	0.122	74.326
29	-18.83	0.114	-169.005	-3.66	0.657	109.317	-3.57	0.663	108.974	-19.91	0.101	61.923
30	-17.58	0.132	140.161	-3.80	0.646	35.608	-3.84	0.643	36.637	-27.92	0.040	63.110
31	-15.55	0.167	101.679	-3.82	0.644	-37.230	-3.96	0.634	-37.460	-18.94	0.113	75.811
32	-15.44	0.169	40.697	-4.04	0.628	-111.005	-3.99	0.632	-110.036	-18.37	0.121	5.602
33	-20.90	0.090	16.803	-4.15	0.620	174.502	-4.16	0.620	174.691	-28.71	0.037	-17.821
34	-13.20	0.219	7.064	-4.67	0.584	99.870	-4.67	0.584	99.870	-14.25	0.194	-21.678
35	-8.44	0.378	-60.157	-4.74	0.579	98.957	-4.74	0.579	98.957	-8.59	0.372	-98.699
36	-7.64	0.415	-133.942	-5.39	0.538	-113.841	-5.39	0.538	-113.841	-7.27	0.433	-173.594
37	-10.08	0.313	147.491	-5.54	0.529	27.050	-5.55	0.528	27.050	-8.84	0.362	114.100
38	-15.54	0.167	46.775	-5.95	0.504	-42.316	-5.78	0.514	-42.316	-12.74	0.231	46.492
39	-19.52	0.106	-41.298	-5.95	0.504	-42.316	-5.92	0.506	-42.316	-18.73	0.116	-41.318
40	-23.38	0.068	-143.118	-6.33	0.482	-46.309	-6.52	0.472	-46.309	-22.07	0.079	-144.118

Note : Data obtained from 2.4-mm connector based modules. This data includes connector loss, and board loss. The measurement reference plane is at the RF connectors.

AMMP-6640 Typical Scattering Parameters^[1] at Max Attenuation (Tc = 25°C, Zo = 50ohm, Vsh = 1.2V, Vser = 0V)

Freq GHZ	S11			S21			S12			S22		
	dB	Mag	Ang	dB	Mag	Ang	dB	Mag	Ang	dB	Mag	Ang
0.045	-22.65	0.074	-3.714	-25.71	0.052	-3.634	-25.65	0.052	-4.117	-22.50	0.075	-4.400
1	-22.90	0.072	-76.451	-25.85	0.051	-73.236	-25.85	0.051	-73.268	-22.09	0.079	-78.259
2	-24.58	0.059	-161.676	-25.99	0.050	-142.222	-26.00	0.050	-142.313	-22.82	0.072	-155.550
3	-24.11	0.062	101.530	-26.11	0.050	148.641	-26.11	0.050	148.392	-23.92	0.064	123.941
4	-21.59	0.083	18.123	-26.29	0.049	80.938	-26.29	0.049	80.889	-25.04	0.056	32.641
5	-19.99	0.100	-52.521	-26.36	0.048	11.652	-26.38	0.048	11.850	-23.66	0.066	-60.708
6	-19.80	0.102	-118.321	-26.43	0.048	-57.839	-26.36	0.048	-57.632	-21.52	0.084	-140.866
7	-21.20	0.087	175.229	-26.58	0.047	-127.196	-26.60	0.047	-126.556	-19.97	0.100	150.187
8	-24.22	0.062	101.309	-26.54	0.047	164.136	-26.65	0.047	164.220	-19.83	0.102	87.098
9	-28.18	0.039	10.139	-26.69	0.046	95.104	-26.71	0.046	94.845	-21.51	0.084	26.935
10	-27.13	0.044	-107.208	-26.82	0.046	25.636	-26.80	0.046	25.494	-24.48	0.060	-36.633
11	-22.88	0.072	172.833	-26.80	0.046	-44.007	-26.78	0.046	-43.968	-31.18	0.028	-115.726
12	-20.74	0.092	103.472	-27.17	0.044	-113.390	-27.15	0.044	-113.310	-33.68	0.021	92.248
13	-20.18	0.098	42.030	-27.01	0.045	177.210	-27.01	0.045	177.121	-26.94	0.045	8.795
14	-21.41	0.085	-15.666	-27.35	0.043	108.097	-27.35	0.043	107.494	-24.41	0.060	-48.851
15	-24.58	0.059	-73.775	-27.23	0.044	38.952	-27.27	0.043	39.013	-23.78	0.065	-106.755
16	-33.27	0.022	-131.968	-27.01	0.045	-30.148	-27.05	0.044	-29.849	-24.08	0.063	-157.699
17	-36.89	0.014	33.229	-27.13	0.044	-100.659	-27.09	0.044	-100.443	-24.64	0.059	155.258
18	-29.84	0.032	-37.420	-27.17	0.044	-171.477	-27.13	0.044	-170.955	-25.87	0.051	109.390
19	-29.79	0.032	-95.142	-27.19	0.044	117.989	-27.23	0.044	118.028	-27.62	0.042	63.939
20	-31.77	0.026	-169.635	-27.33	0.043	46.694	-27.35	0.043	46.739	-29.00	0.036	3.213
21	-31.87	0.026	88.863	-27.35	0.043	-24.938	-27.35	0.043	-24.771	-28.31	0.038	-72.475
22	-28.71	0.037	6.714	-27.51	0.042	-97.398	-27.54	0.042	-97.529	-25.92	0.051	-134.415
23	-25.73	0.052	-48.316	-28.20	0.039	-168.786	-28.18	0.039	-168.784	-26.41	0.048	-174.685
24	-23.15	0.070	-76.807	-27.92	0.040	125.832	-27.94	0.040	125.616	-33.76	0.021	174.607
25	-19.86	0.102	-106.347	-27.58	0.042	53.711	-27.56	0.042	53.591	-23.62	0.066	-136.505
26	-18.38	0.121	-140.847	-27.41	0.043	-18.981	-27.62	0.042	-18.782	-17.41	0.135	-174.422
27	-17.76	0.129	-175.089	-27.56	0.042	-91.333	-27.60	0.042	-90.375	-14.88	0.180	142.396
28	-19.65	0.104	145.839	-27.94	0.040	-162.675	-27.70	0.041	-162.228	-14.52	0.188	97.127
29	-24.70	0.058	135.946	-27.47	0.042	125.616	-27.43	0.043	124.900	-17.42	0.135	54.318
30	-21.86	0.081	152.131	-27.72	0.041	48.274	-27.79	0.041	48.827	-26.07	0.050	29.690
31	-16.86	0.144	118.511	-28.11	0.039	-19.913	-28.16	0.039	-20.146	-24.05	0.063	88.323
32	-13.96	0.201	69.230	-28.34	0.038	-93.457	-28.34	0.038	-92.178	-17.59	0.132	49.524
33	-12.33	0.242	16.310	-28.29	0.039	-166.667	-28.31	0.038	-166.374	-14.70	0.184	-12.282
34	-11.62	0.262	-39.798	-28.83	0.036	122.947	-28.73	0.037	123.266	-12.76	0.230	-74.027
35	-11.95	0.253	-94.751	-28.92	0.036	51.835	-28.90	0.036	52.203	-11.89	0.254	-130.447
36	-14.17	0.196	-147.819	-28.78	0.036	-18.645	-28.73	0.037	-19.127	-12.22	0.245	176.047
37	-19.35	0.108	165.315	-28.36	0.038	-91.062	-28.54	0.037	-90.514	-14.09	0.198	123.529
38	-34.02	0.020	-75.922	-28.34	0.038	-93.457	-27.87	0.040	-163.455	-19.13	0.111	79.380
39	-16.68	0.147	-129.367	-29.92	0.032	113.135	-29.71	0.033	114.797	-23.81	0.065	75.556
40	-12.69	0.232	177.764	-30.52	0.030	53.536	-30.46	0.030	53.353	-22.29	0.077	30.587

Note : Data obtained from 2.4-mm connector based modules. This data includes connector loss, and board loss. The measurement reference plane is at the RF connectors.

AMMP-6640 Biasing and Operation

The AMMP-6640 attenuator is driven by voltage ramps placed on V_{series} and V_{shunt} control pins. Operation in this mode requires voltages between 0 to 1.5 volts for V_{se} and 0 to 1.5 volts for V_{sh} . The recommended DC control voltage range is $V_{se} = 0$ to 1.2 volts and $V_{sh} = 0$ to 1.2 volts. A simplified schematic for the AMMP-6640 is shown in Figure 17.

In the minimum attenuation state, the series FETs are fully biased at 1.2 volts and the shunt FETs are in the full "off" state at 0 volts. Inversely, for a maximum attenuation state, the series FETs are "off" at 0 volts bias and the shunt FETs are fully on at 1.2 volts. Achieving attenuation levels in-between these two states requires voltage levels similar to those in Table 4. Applying voltage to the shunt FETs sets the source to drain resistance and establishes the main attenuation level. The match is optimized by the amount of bias applied to the series FETs. The match will determine how flat the attenuation level is across a broadband operational range.

Table 4. AMMP-6640 Typical Control Voltages

Attenuation (dB)	V_{series} (V)	V_{shunt} (V)
0	1.2	0
2	0.440	0.325
4	0.435	0.383
6	0.430	0.416
8	0.420	0.440
10	0.410	0.465
12	0.400	0.480
14	0.385	0.505
16	0.375	0.535
18	0.360	0.575
20	0.350	0.650
22	0.346	0.845
max	0	1.2

Package Dimension, PCB Layout and Tape and Reel information

Please refer to Avago Technologies Application Note 5520, AMxP-xxxx production Assembly Process (Land Pattern A).

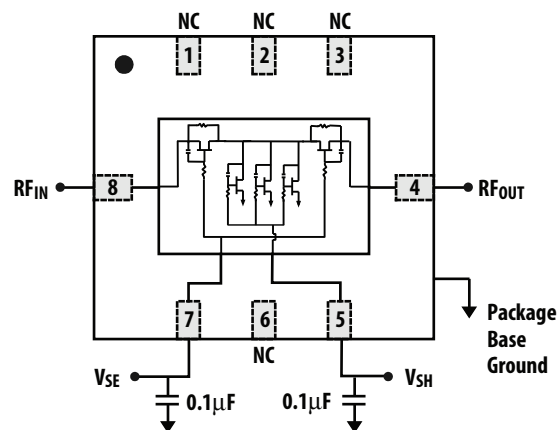

Figure 17. AMMP-6640 Schematic

Ordering Information

Part Number	Devices Per Container	Container
AMMP-6640-BLKG	10	Antistatic bag
AMMP-6630-TR1G	100	7" Reel
AMMP-6630-TR2G	500	7" Reel

For product information and a complete list of distributors, please go to our web site: www.avagotech.com

Avago, Avago Technologies, and the A logo are trademarks of Avago Technologies in the United States and other countries. Data subject to change. Copyright © 2005-2013 Avago Technologies. All rights reserved. AV02-2236EN - July 9, 2013

AVAGO
TECHNOLOGIES