



Chipsmall Limited consists of a professional team with an average of over 10 year of expertise in the distribution of electronic components. Based in Hongkong, we have already established firm and mutual-benefit business relationships with customers from,Europe,America and south Asia,supplying obsolete and hard-to-find components to meet their specific needs.

With the principle of “Quality Parts,Customers Priority,Honest Operation,and Considerate Service”,our business mainly focus on the distribution of electronic components. Line cards we deal with include Microchip,ALPS,ROHM,Xilinx,Pulse,ON,Everlight and Freescale. Main products comprise IC,Modules,Potentiometer,IC Socket,Relay,Connector.Our parts cover such applications as commercial,industrial, and automotives areas.

We are looking forward to setting up business relationship with you and hope to provide you with the best service and solution. Let us make a better world for our industry!



## Contact us

Tel: +86-755-8981 8866 Fax: +86-755-8427 6832

Email & Skype: info@chipsmall.com Web: www.chipsmall.com

Address: A1208, Overseas Decoration Building, #122 Zhenhua RD., Futian, Shenzhen, China



# AN1433SSM

## High accuracy, variable output, low voltage operation shunt regulator

### ■ Overview

The AN1433SSM is a low voltage operation and highly accurate positive voltage variable output type shunt regulator IC. Since the output voltage is adjustable from approximately 1.25 V to 15 V, it is suitable for a power supply of small-sized 3 V-system portable equipment. Also, it contributes to the miniaturization of set equipment by the adoption of the small type surface mounting package.

### ■ Features

- Highly accurate reference voltage: 1.25 V (allowance:  $\pm 1\%$ )
- Low voltage operation: 1.25 V to 14 V
- Small type surface mounting package

### ■ Applications

- Cellular phone, PHS, office automation equipment and other small-sized portable equipment

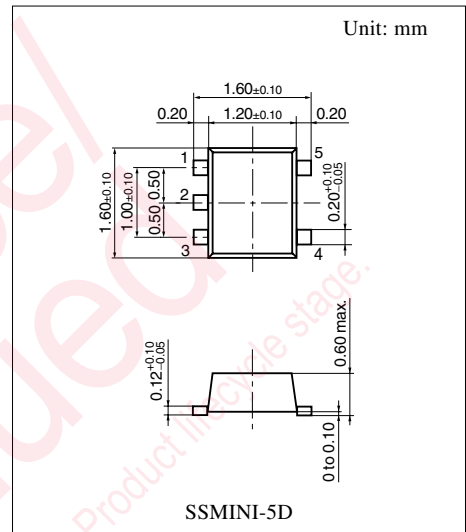

Note) The package of this product will be changed to lead-free type (SSMINI-5DA). See the new package dimensions section later of this datasheet.

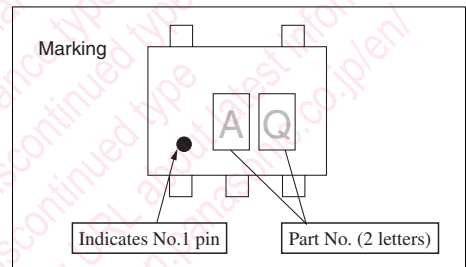

### ■ Block Diagram

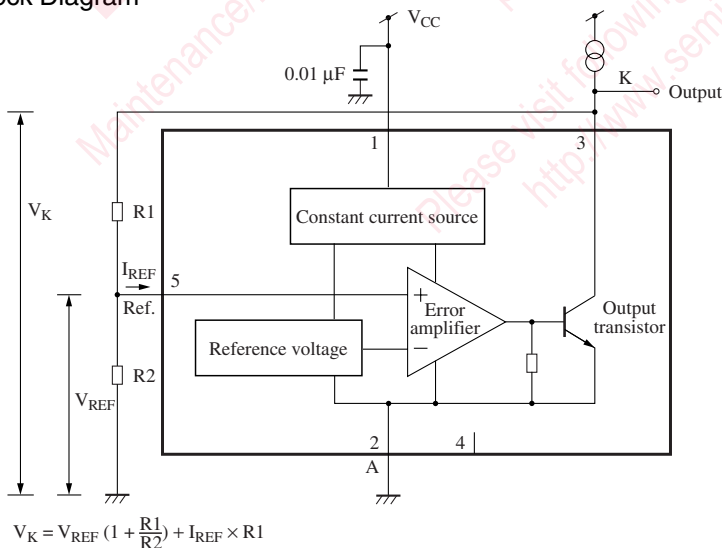

### ■ Pin Descriptions

Pin No.	Description	
1	$V_{CC}$	Power source current supply pin.
2	Anode	The reference voltage pin for the constant voltage of this shunt regulator IC. The current from $V_{CC}$ , cathode and reference flow out from this pin.
3	K: Cathode	The constant voltage output pin of this shunt regulator. The supplied current more than necessary to this pin is bypassed to anode pin by the output transistor.
4	N.C.	Nothing is connected to this pin. If high voltage is applied, the characteristics of the IC may be affected.
5	Reference	The reference voltage (1.25 V typical) pin. Although the impedance is high under the normal using conditions, be careful that the impedance drops and current flows into the IC inside if a current or voltage is forced to apply from the outside.

### ■ Absolute Maximum Ratings

Parameter	Symbol	Rating	Unit
Cathode voltage	$V_K$	14.2	V
Reference voltage	$V_{REF}$	7	V
Supply current	$I_K$	1.5	mA
Reference current	$I_{REF}$	50	$\mu$ A
Cathode-anode reverse current	$-I_{KA}$	-10	mA
Cathode-reference reverse current	$-I_{KR}$	-10	mA
Cathode current	$I_K$	20	mA
Power dissipation <sup>*2</sup>	$P_D$	50	mW
Operating ambient temperature <sup>*1</sup>	$T_{opr}$	-30 to +85	$^{\circ}$ C
Storage temperature <sup>*1</sup>	$T_{stg}$	-55 to +150	$^{\circ}$ C

Note) 1. Do not apply external currents or voltages to any pins not specifically mentioned.

For circuit currents, '+' denotes current flowing into the IC and '-' denotes current flowing out of the IC.

2. <sup>\*1</sup>: Except for the power dissipation, operating ambient temperature and storage temperature, all ratings are for  $T_a = 25^{\circ}$ C.

<sup>\*2</sup>: The value at  $T_a = 85^{\circ}$ C.

### ■ Recommended Operating Range

Parameter	Symbol	Range	Unit
Supply voltage	$V_{CC}$	$V_{REF}$ to 14	V



### ■ Electrical Characteristics at $V_{CC} = 1.8\text{ V}$ , $T_a = 25^\circ\text{C}$

Parameter	Symbol	Conditions	Min	Typ	Max	Unit
Reference voltage	$V_{REF}$	$I_K = 10\text{ mA}$	1.2375	1.25	1.2625	V
Reference voltage supply voltage fluctuation	$\frac{\Delta V_{REF}}{\Delta V_{CC}}$	$1.7\text{ V} \leq V_{CC} \leq 14.0\text{ V}$ , $I_K = 10\text{ mA}$	—	-0.73	-1.5	mV/V
Reference voltage cathode current fluctuation	$\frac{\Delta V_{REF}}{\Delta I_K}$	$0.2\text{ mA} \leq I_K \leq 20\text{ mA}$	—	0.04	0.3	mV/mA
Reference input current	$I_{REF}$	$R_1 = 10\text{ k}\Omega$ , $I_K = 10\text{ mA}$	—	4.0	10	$\mu\text{A}$
Minimum cathode current	$I_{K\text{ min}}$	$V_K = V_{REF}$	—	—	0.2	mA
Off time total current	$I_{OFF}$	$V_K = 14.0\text{ V}$ , $V_{REF} = 0\text{ V}$	—	—	1	$\mu\text{A}$
Cathode saturation voltage	$V_{K\text{ sat}}$	$I_K = 10\text{ mA}$ , $V_{REF} = 1.3\text{ V}$	—	0.08	0.15	V
Supply current	ICC	$I_K = 10\text{ mA}$	—	0.75	1.50	mA

### • Design reference data

Note) The characteristics listed below are theoretical values based on the IC design and are not guaranteed.

Parameter	Symbol	Conditions	Reference value	Unit
Reference voltage change with temperature	$\frac{\Delta V_{REF}}{\Delta T_a}$	$V_{KA} = V_{REF}$ , $I_{KA} = 10\text{ mA}$ $0^\circ\text{C} \leq T_a \leq +70^\circ\text{C}$	3	mV
Reference input current change with temperature	$\frac{\Delta I_{REF}}{\Delta T_a}$	$R_1 = 10\text{ k}\Omega$ , $I_K = 10\text{ mA}$ $0^\circ\text{C} \leq T_a \leq +70^\circ\text{C}$	1.1	mA

### ■ Application Notes

#### 1. $P_D - T_a$ curves of SSMINI-5D package

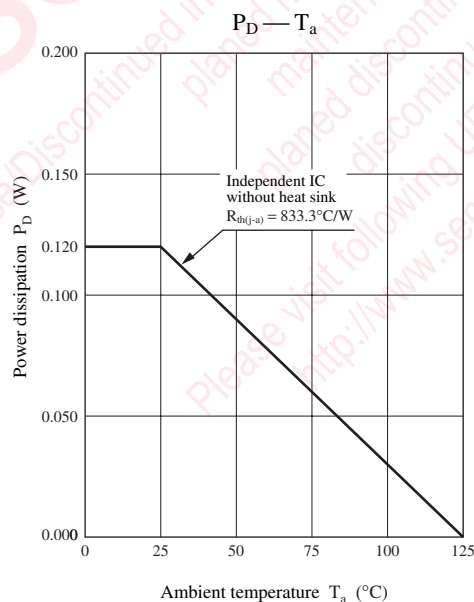

■ Application Notes (continued)

2. Main Characteristics

Supply current

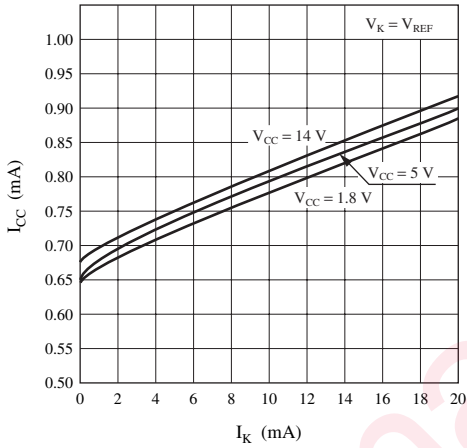

Reference input current

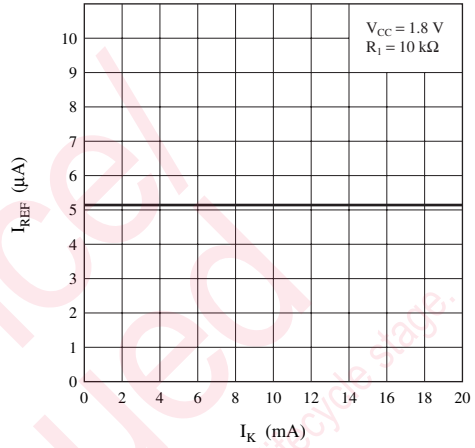

Reference voltage (temperature characteristics)

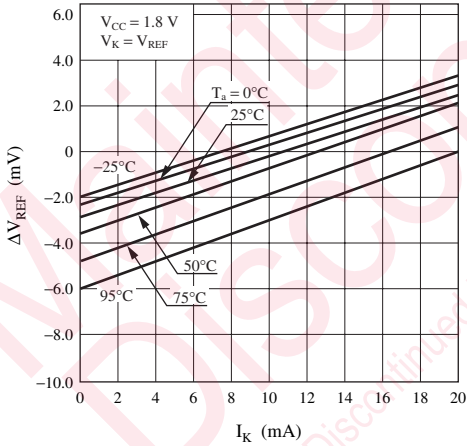

Reference current (temperature characteristics)

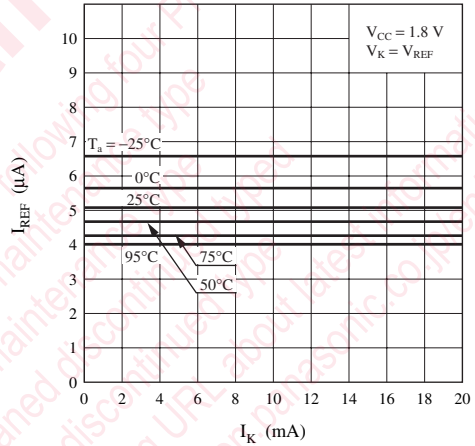

Reference voltage supply voltage fluctuation

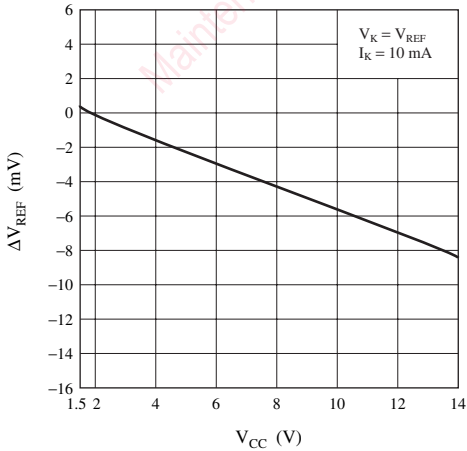

Reference voltage cathode current fluctuation

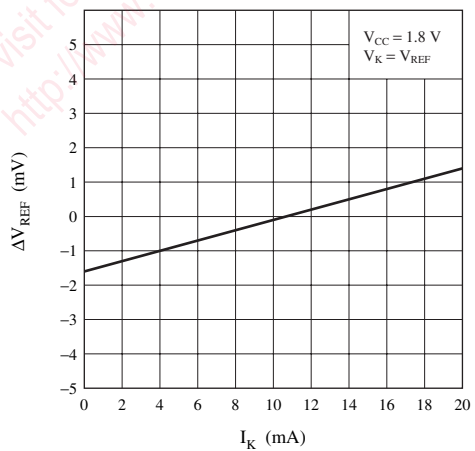

■ Application Notes (continued)

2. Main Characteristics (continued)

$V_{REF}$  temperature characteristic

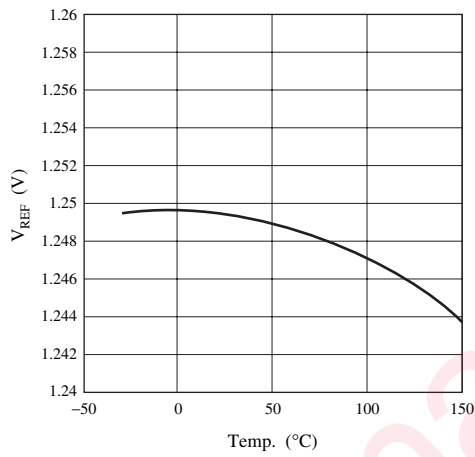

Cathode saturation voltage

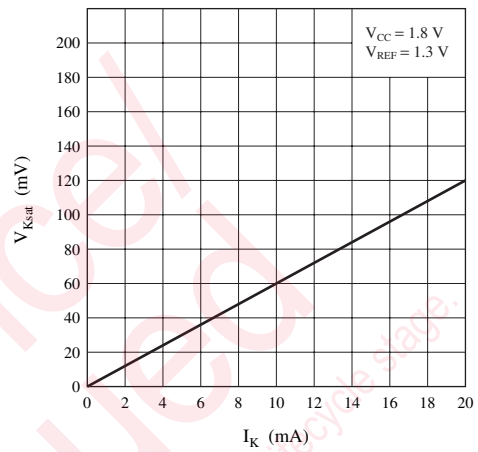

Minimum cathode current

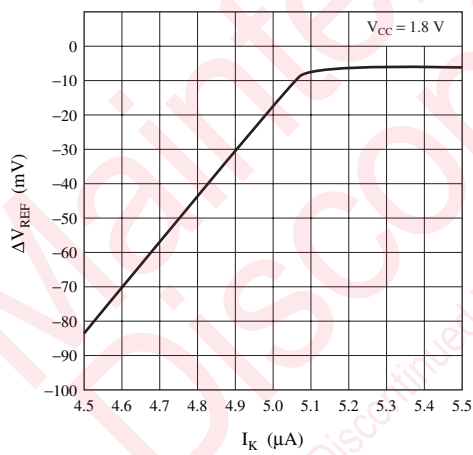

■ Application Circuit Example

This circuit amplifies the error voltage of the secondary side output voltage in the insulation type switching power supply, then transfers it to the primary side via a photocoupler.

Replaceable with the conventional products (AN1431M, AN1431T, AN1432MS).

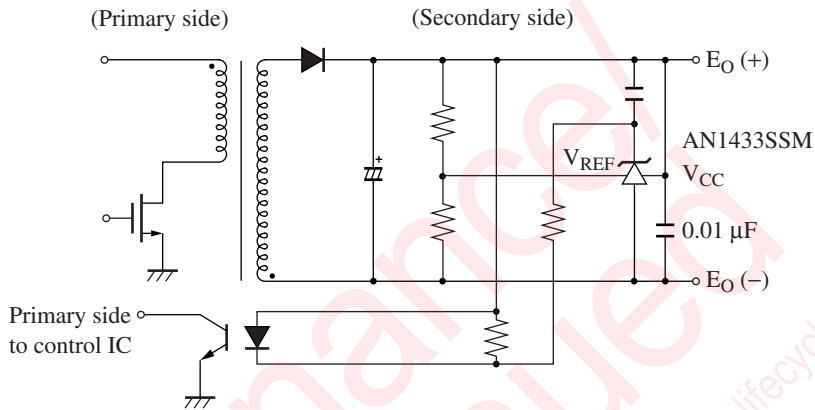

Note) As  $V_{CC}$  and cathode pin are separated,  $V_K$  can operate till  $0.15 V_{max}$  (at  $I_K = 10 \text{ mA}$ ) at least.

■ New Package Dimensions (Unit: mm)

- SSMINI-5DA (Lead-free package)

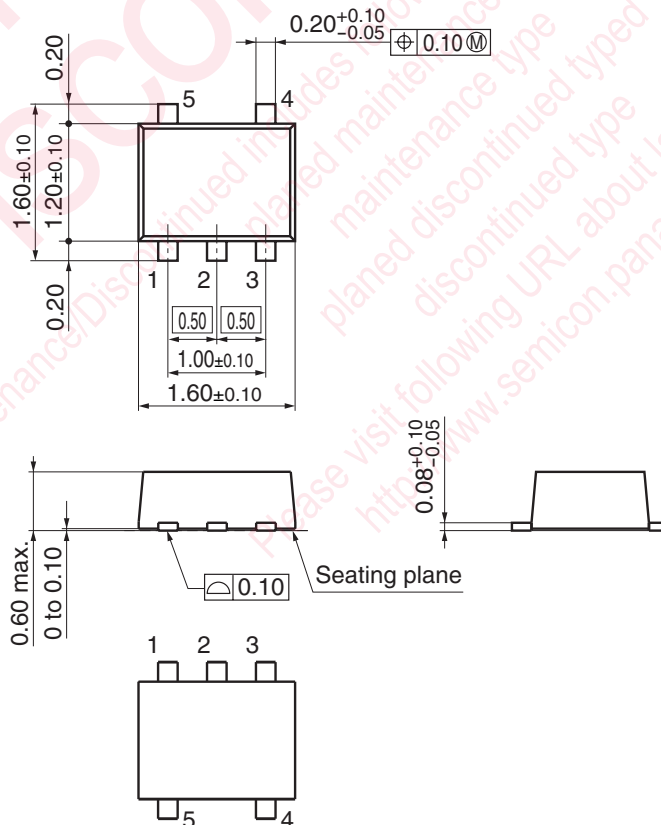

## Request for your special attention and precautions in using the technical information and semiconductors described in this book

- (1) If any of the products or technical information described in this book is to be exported or provided to non-residents, the laws and regulations of the exporting country, especially, those with regard to security export control, must be observed.
- (2) The technical information described in this book is intended only to show the main characteristics and application circuit examples of the products, and no license is granted under any intellectual property right or other right owned by our company or any other company. Therefore, no responsibility is assumed by our company as to the infringement upon any such right owned by any other company which may arise as a result of the use of technical information described in this book.
- (3) The products described in this book are intended to be used for standard applications or general electronic equipment (such as office equipment, communications equipment, measuring instruments and household appliances).  
Consult our sales staff in advance for information on the following applications:
  - Special applications (such as for airplanes, aerospace, automobiles, traffic control equipment, combustion equipment, life support systems and safety devices) in which exceptional quality and reliability are required, or if the failure or malfunction of the products may directly jeopardize life or harm the human body.
  - Any applications other than the standard applications intended.
- (4) The products and product specifications described in this book are subject to change without notice for modification and/or improvement. At the final stage of your design, purchasing, or use of the products, therefore, ask for the most up-to-date Product Standards in advance to make sure that the latest specifications satisfy your requirements.
- (5) When designing your equipment, comply with the range of absolute maximum rating and the guaranteed operating conditions (operating power supply voltage and operating environment etc.). Especially, please be careful not to exceed the range of absolute maximum rating on the transient state, such as power-on, power-off and mode-switching. Otherwise, we will not be liable for any defect which may arise later in your equipment.
  - Even when the products are used within the guaranteed values, take into the consideration of incidence of break down and failure mode, possible to occur to semiconductor products. Measures on the systems such as redundant design, arresting the spread of fire or preventing glitch are recommended in order to prevent physical injury, fire, social damages, for example, by using the products.
- (6) Comply with the instructions for use in order to prevent breakdown and characteristics change due to external factors (ESD, EOS, thermal stress and mechanical stress) at the time of handling, mounting or at customer's process. When using products for which damp-proof packing is required, satisfy the conditions, such as shelf life and the elapsed time since first opening the packages.
- (7) This book may be not reprinted or reproduced whether wholly or partially, without the prior written permission of Matsushita Electric Industrial Co., Ltd.