



Chipsmall Limited consists of a professional team with an average of over 10 year of expertise in the distribution of electronic components. Based in Hongkong, we have already established firm and mutual-benefit business relationships with customers from,Europe,America and south Asia,supplying obsolete and hard-to-find components to meet their specific needs.

With the principle of "Quality Parts,Customers Priority,Honest Operation,and Considerate Service",our business mainly focus on the distribution of electronic components. Line cards we deal with include Microchip,ALPS,ROHM,Xilinx,Pulse,ON,Everlight and Freescale. Main products comprise IC,Modules,Potentiometer,IC Socket,Relay,Connector.Our parts cover such applications as commercial,industrial, and automotives areas.

We are looking forward to setting up business relationship with you and hope to provide you with the best service and solution. Let us make a better world for our industry!



Contact us

Tel: +86-755-8981 8866 Fax: +86-755-8427 6832

Email & Skype: info@chipsmall.com Web: www.chipsmall.com

Address: A1208, Overseas Decoration Building, #122 Zhenhua RD., Futian, Shenzhen, China



INTEGRATED WIRELESS POWER SUPPLY RECEIVER, Qi (WIRELESS POWER CONSORTIUM) COMPLIANT

— AN32258A —

FEATURES

- Integrated Wireless Power Receiver Solution
- WPC Ver. 1.1 Compliant
- Synchronous Full Bridge Rectifier Control
- Input Voltage Range : VRECT = 4.4 V to 19 V
- Output Voltage: 5 V
- Temperature Detecting Circuit
- Full Charge Detection with Adjustable Current Level
- Switching Control of External Power Supply
- Supports Under Voltage Lockout , Thermal Shutdown, Over Voltage Detection, and Over Current Detection.
- LED Indicator
- 3.16 mm X 3.16 mm WLCSP
48 Pins with 0.4mm pitch

DESCRIPTION

AN32258A is a wireless power system controller IC which is compliant with Qi version 1.1 of the System Description Wireless Power Transfer, Volume 1 for Low Power defined by Wireless Power Consortium. AN32258A is a controller IC of a power receiver (Rx) which can be used with any Qi-compliant wireless chargers.

APPLICATIONS

- WPC Compliant Receivers
- Cell Phones, Smartphones
- Headsets
- Digital Cameras
- Tablet Devices
- Portable Media Players etc.

IMPORTANT

AN32258A is designed to be used based on the circuits and external components described in this document and Application Note. Therefore, Panasonic cannot support any inquiries of modified solution.

Wireless Power System

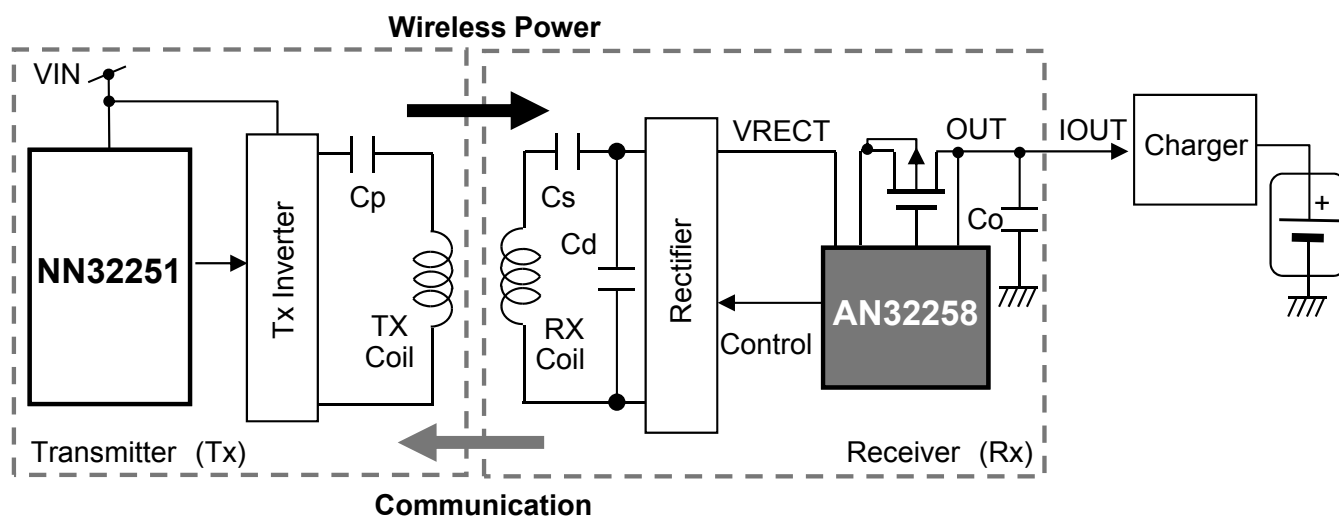

CONTENTS

■ FEATURES	1
■ DESCRIPTION	1
■ APPLICATIONS	1
■ ABSOLUTE MAXIMUM RATINGS	3
■ POWER DISSIPATION RATING	4
■ RECOMMENDED OPERATING CONDITIONS	4
■ ELECTRICAL CHARACTERISTICS	5
■ PIN CONFIGURATION	8
■ PIN FUNCTIONS	9
■ CIRCUIT DIAGRAM	14
■ FUNCTIONS	15
■ PACKAGE INFORMATION	29
■ IMPORTANT NOTICE	30

DELIVERY INFORMATION

Order Number	Package	Output Supply	Minimum Quantity
AN32258A-PR	48 pin WLCSP(3.2 × 3.2mm)	Embossed Taping	5000pcs

ABSOLUTE MAXIMUM RATINGS

Parameter	Symbol	Rating	Unit	Notes
Supply voltage	V_{RECT}	20	V	*1
	V_{EXT}	6.9	V	*1
Output current	I_{RECT}	—	A	*1
Operating ambient temperature	T_{opr}	− 30 to + 85	°C	*2
Operating junction temperature	T_j	−40 to +125	°C	*2
Storage temperature	T_{stg}	− 50 to + 125	°C	*2
Input voltage range	$V_{TD2}, V_{TD1}, V_{SC2}, V_{SC1}, V_{ISENSE1}$	− 0.3 to 20	V	*1
	V_{OUT}, V_{LED}	− 0.3 to 12	V	*1
	$V_{VTH}, V_{FCCNT}, V_{FODG}, V_{FULLCH}, V_{FOD}, V_{FODL}$	− 0.3 to ($V_{VREG34V} + 0.3$)	V	*1
Output voltage range	V_{VPGATE}	− 0.3 to ($V_{RECT} + 0.3$)	V	*1
	V_{DT1H}	− 0.3 to ($V_{sc1} + V_{VREG47V} + 0.3$)	V	*1
	V_{DT2H}	− 0.3 to ($V_{sc2} + V_{VREG47V} + 0.3$)	V	*1
	V_{DT2L}, V_{DT1L}	− 0.3 to ($V_{VREG47V} + 0.3$)	V	*1
	V_{EXTCNT}	− 0.3 to ($V_{EXT} + 0.3$)	V	*1
	V_{MEMBAT}	− 0.3 to ($V_{VREG34V} + 0.3$)	V	*1
ESD	TD2	1.0	kV	—
	HBM (Human Body Model) ISENSE1, ISENSE2, ISENSE1-S, ISENSE1-S1	1.5	kV	—
	HBM (Human Body Model) Except for pins above	2	kV	—

Note) This product may sustain permanent damage if the actual condition is higher than the absolute maximum rating stated above. This rating is the maximum stress, and device will not be guaranteed to operate in case it is higher than our stated range. When exposed to the absolute maximum rating for a long time, the reliability of the product may be affected.

*1: The values under the condition not exceeding the above absolute maximum ratings and the power dissipation.

*2: Except for the power dissipation, operating ambient temperature, and storage temperature, all ratings are for $T_a = 25\text{ °C}$.

POWER DISSIPATION RATING

PACKAGE	θ_{j-a}	θ_{j-c}	PD (Ta = 25 °C)	PD (Ta = 85 °C)	Notes
Wafer Level Chip Size Package (WLCSP type)	631.4 °C / W	7.2 °C /W	0.158 W	0.0632 W	*1

Note). *1 :For the actual usage, please refer to the PD-Ta characteristics diagram in the package specification, and follow the power supply voltage, load and ambient temperature conditions to ensure that there is enough margin and the thermal design does not exceed the allowable value.



CAUTION

Although this device has limited built-in ESD protection circuit, permanent damage may occur on it. Therefore, proper ESD precautions are recommended to avoid electrostatic damage to the MOS gates

RECOMMENDED OPERATING CONDITIONS

Parameter	Pin Name	Min.	Typ.	Max.	Unit	Notes
Supply voltage range	V _{RECT}	4.4	8	19	V	*2
	V _{EXT}	4.4	5	6	V	
Input voltage range	V _{ISENSE1}	4.4	8	19	V	
	V _{TD2}	-0.3	—	20	V	
	V _{TD1}	-0.3	—	20	V	
	V _{SC2}	-0.3	—	20	V	
	V _{SC1}	-0.3	—	20	V	
	V _{OUT}	-0.3	—	7	V	
	V _{LED}	-0.3	—	7	V	
	V _{VTH}	-0.3	—	V _{VREG34V} + 0.3	V	
	V _{FCCNT}	-0.3	—	V _{VREG34V} + 0.3	V	
	V _{FODG}	-0.3	—	V _{VREG34V} + 0.3	V	
	V _{FULLCH}	-0.3	—	V _{VREG34V} + 0.3	V	
	V _{FOD}	-0.3	—	V _{VREG34V} + 0.3	V	

Note) Do not apply external currents or voltages to any pin not specifically mentioned.

*2 : The values under the condition not exceeding the above absolute maximum ratings and the power dissipation.

ELECTRICAL CHARACTERISTICS

Co = 10 μF, V_{RECT} = 8 V, T_a = 25 °C ± 2 °C unless otherwise noted.

Parameter	Symbol	Condition	Limits			Unit	Note
			Min	Typ	Max		
Current Consumption							
Quiescent current	I _{STBY}		10	12	14	mA	
Under-voltage lock-out (UVLO)							
Under-voltage lock-out	V _{UVLO}	V _{RECT} : 0V -> 5V	3.29	3.5	3.71	V	
Hysteresis on UVLO	V _{UVLOHY}	V _{RECT} : 5V -> 3V	-	0.7	-	V	*1
Over-voltage protection (OVP)							
Input overvoltage threshold	V _{OVP}	V _{RECT} : 5V -> 19V	17	18	19	V	
Hysteresis on OVP	V _{OVPHY}	V _{RECT} : 19V -> 5V	-	4	-	V	*1
V_{RECT} (5W, LDO 5V mode)							
V _{RECT} Threshold1	V _{RECTTH1}	In increasing I _{OUT} < 125mA In decreasing I : I _{OUT} < 60mA	-	8	-	V	*1
V _{RECT} Threshold2	V _{RECTTH2}	In increasing 125mA < I _{OUT} < 420mA In decreasing 60mA < I _{OUT} < 360mA	-	5.4	-	V	*1
V _{RECT} Threshold3	V _{RECTTH3}	In increasing I _{OUT} > 420mA In decreasing I _{OUT} > 360mA	-	5.1	-	V	*1
OUTPUT							
V _{OUT} (5W, LDO 5V mode)	V _{OUT1}	V _{RECT} =8V , I _{OUT} =10mA	4.76	5	5.24	V	
	V _{OUT2}	V _{RECT} =5.1V , I _{OUT} =1000mA	4.76	—	—	V	

Note)*1 : Designed typical values

ELECTRICAL CHARACTERISTICS (Continued)

Co = 10 μF, V_{RECT} = 8 V, T_a = 25 °C ± 2 °C unless otherwise noted.

Parameter	Symbol	Condition	Limits			Unit	Note
			Min	Typ	Max		
Temperature Detection [Thermistor : ERTJ0EV104F]							
Over-temperature Detection Voltage	V _{TH}	60 ±C detection VTHR:47 kohm (±1%)	0.887	0.975	1.069	V	
Over-current protection (OCP)							
Over-current threshold voltage 1	V _{OCP1}	—	1.25	1.5	1.75	A	
Thermal protection							
Thermal shutdown temperature	T _j	—	—	150	—	°C	*1
Thermal shutdown hysteresis	T _{jhys}	—	—	20	—	°C	*1
External voltage detection							
V _{EXT} Rising threshold voltage	V _{EXTTH}	—	3.99	4.2	4.41	V	
V _{EXT} hysteresis	V _{EXTHY}	—	—	0.4	—	V	*1
Terminal voltage (FULLCH)							
High input threshold (Termination)	V _{IH1}	—	1.6	—	—	V	
Low input threshold	V _{IL1}	—	-0.2	—	0.2	V	
Terminal voltage (FODL)							
High input threshold (Termination)	V _{IH1}	—	1.6	—	—	V	
Low input threshold	V _{IL1}	—	-0.2	—	0.2	V	

Notes) *1 : Designed typical values

ELECTRICAL CHARACTERISTICS (Continued)

Co = 10 μF, V_{RECT} = 8 V, T_a = 25 °C ± 2 °C unless otherwise noted.

Parameter	Symbol	Condition	Limits			Unit	Note
			Min	Typ	Max		
LEDCNT							
LED Saturation voltage	LED _{SAT}	I _{LED} = 20mA	—	—	0.5	V	—
LED Leak current	LED _{LEAK}	LED = 7.5V	—	—	10	μA	—

Pin Layout

Top View

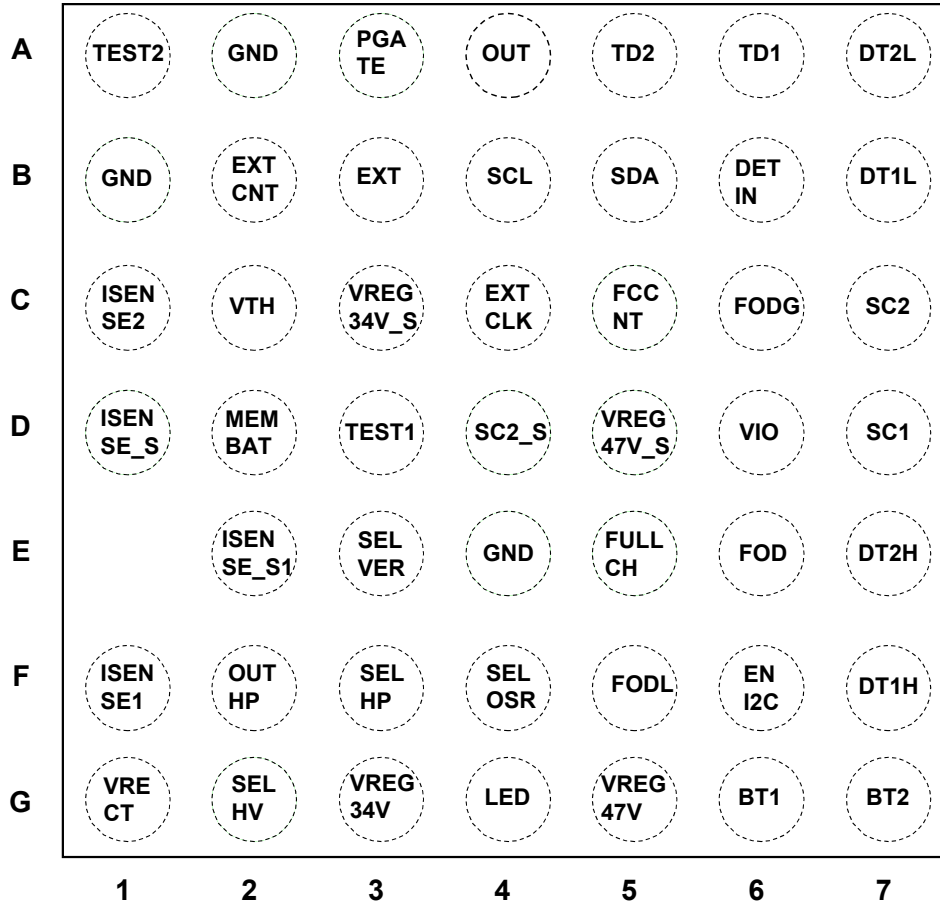

PIN FUNCTIONS

Pin	Name	I/O	Function	Description
A1	TEST2	I	Test pin	Connect to GND. Panasonic uses this pin for test purposes only.
A2,B1, E4	GND	GND	Ground	—
A3	PGATE	O	LDO control	Controls the PMOS gate of the LDO
A4	OUT	I	LDO feedback	Connects to the PMOS drain of the LDO
A5	TD2	O	Drive load to transmit 2	Controls capacitive load modulation for Qi data
A6	TD1	O	Drive load to transmit 1	Controls capacitive load modulation for Qi data
A7	DT2L	O	Rectification low side switch gate control 2	Controls the switching gate of the low side of the rectifier
B2	EXTCNT	O	External PMOS control	Controls the switch to an external power supply. This pin is internally connected to the drain of NMOS to use under 2mA. When EXT is larger than 4.2V, EXTCNT will become low and the external MOSFET will turn on.
B3	EXT	Power Supply	External power detection	Supplies power externally in direct. When EXT becomes larger than 4.2V, EXTCNT will become low and the wireless power transmission will stop. The external power supply will then directly output, and the Tx will be stopped. (Refer to the circuit diagram followed by Pin Functions.)
B4	SCL	I	Test pin	Leave this pin open. Panasonic uses this pin for test purposes only.
B5	SDA	I/O	Test pin	Leave this pin open. Panasonic uses this pin for test purposes only.
B6	DETIN	I	Test pin	Leave this pin open. Panasonic uses this pin for test purposes only.

PIN FUNCTIONS (Continued)

Pin	Name	I/O	Function	Description
B7	DT1L	O	Rectification Low side Switch Gate Control 1	Controls the switching gate of the low side of the rectifier
C1	ISENSE2	I	Current sensor 2	Detects the output current from LDO. Connect this pin to ISENSE1-S1(E2).
C2	VTH	I	Thermistor voltage	Connect to a thermistor placed where temperature needs to be measured to prevent over heat. Connect to VREG34V (G3) if thermistors are not in use.
C3	VREG34V_S	O	Internal regulator sense output	This pin is shorted internally to VREG34V(G3).
C4	EXTCLK	I	Test pin	Leave this pin open. Panasonic uses this pin for test purposes only.
C5	FCCNT	I	Full charge control	Connect a pull-down resistor to set an automatic full-charge detecting current. For example, when a resistor of 100kohm is used, decreasing output current to less than 80mA will shutdown the LDO, and also data is sent to Tx to stop power transmission. The current detection starts 5 seconds after power transmission starts. Using this pin can also replace the full-charge control from FULLCH(E5).

PIN FUNCTIONS (Continued)

Pin	Name	I/O	Function	Description
C6	FODG	I	FOD gain control	Connect a pull-down resistor to adjust the gain level of Received Power Packet defined in WPC specification. The resistance can be varied from 10k ohms to 180k ohms.
C7	SC2	I	Synchronous rectifier control 2	Connect to the rectifier to detect its voltage level.
D1	ISENSE1_S	I	Sense pin for ISENSE1	Connect to the source of the LDO's MOSFET to detect the output current. A sense resistor of 50mohms is connected to ISENSE1(F1) inside the IC.
D2	MEMBAT	O	Random number memory adjustment	Connect a capacitor of 1uF to fix a memory time.
D3	TEST1	O	Test pin	Leave this pin open. Panasonic uses this pin for test purposes only.
D4	SC2_S	I	Synchronous rectifier sense pin	Leave this pin open. Panasonic uses this pin to sense SC2(C7) for test purposes only.
D5	VREG47V_S	O	Internal regulator sense output	This pin is shorted internally to VREG47V(G5).
D6	VIO	I	Test pin	Leave this pin open. Panasonic uses this pin for test purposes only.
D7	SC1	I	Synchronous rectifier control 1	Connect to the rectifier to detect its voltage level.
E2	ISENSE1_S1	I	Sense pin 1 for ISENSE1	Connect to ISENSE2(C1) to detect the output current. Refer to the circuit diagram followed by Pin Functions.
E3	SELVER	I	Test pin	Leave this pin open. Panasonic uses this pin for test purposes only.

PIN FUNCTIONS (Continued)

Pin	Name	I/O	Function	Description
E5	FULLCH	I	Full charge detection	This input controls the full charge detection externally such as from an MCU. When a high voltage level (over 1.6V) is inputted for over 50us, AN32258A will recognize it as full-charge and send packets to Tx to stop the power transmission. Right after the input becomes low, the power transmission can restart.
E6	FOD	O	Foreign object detection offset	Connect a pull-down resistor to adjust the offset level of received power of WPC specification. For example, a pull-down resistor of 100kohm will set the offset to be zero. Refer to No.3 of the Functions section.
E7	DT2H	O	Rectification high side switch gate control 2	Controls the switching gate of the high side of the rectifier
F1	ISENSE1	I	Current sensor 1	Connect to VRECT(G1) to detect the output current. A sense resistor of 50mohms is connected to ISENSE1-S(D1) inside the IC.
F2	OUTHHP	O	TEST pin	Leave this pin open. Panasonic uses this pin for test purposes only.
F3	SELHP	I	TEST pin	Connect to GND. Panasonic uses this pin for test purposes only.
F4	SELOSR	I	TEST pin	Connect to GND. Panasonic uses this pin for test purposes only.

PIN FUNCTIONS (Continued)

Pin	Name	I/O	Function	Description
F5	FODL	I	Foreign object detection offset for low current	Inputting a logical high level (over 1.6V) will introduce an offset to Received Power Packet when IOOUT is small. When GND is inputted, no offset will be added.
F6	ENI2C	O	Test pin	Leave this pin open. Panasonic uses this pin for test purposes only.
F7	DT1H	O	Rectification high side switch gate control 1	Controls the switching gate of high side of the rectifier
G1	VRECT	Power Supply	Voltage of rectifier	Voltage of the rectifier output becomes the power supply of AN32258A.
G2	SELHV	I	Test pin	Leave this pin open. Panasonic uses this pin for test purposes only.
G3	VREG34V	O	Internal regulator output	Outputs a voltage level of 3.4V.
G4	LED	O	LED control	This pin is internally connected to the drain of NMOS which turns on when the LDO outputs a voltage.
G5	VREG47V	O	Internal regulator output	Outputs a voltage level of 4.7V.
G6	BT1	O	Boot strap 1	Connect to the rectifier
G7	BT2	O	Boot strap 2	Connect to the rectifier

CIRCUIT DIAGRAM

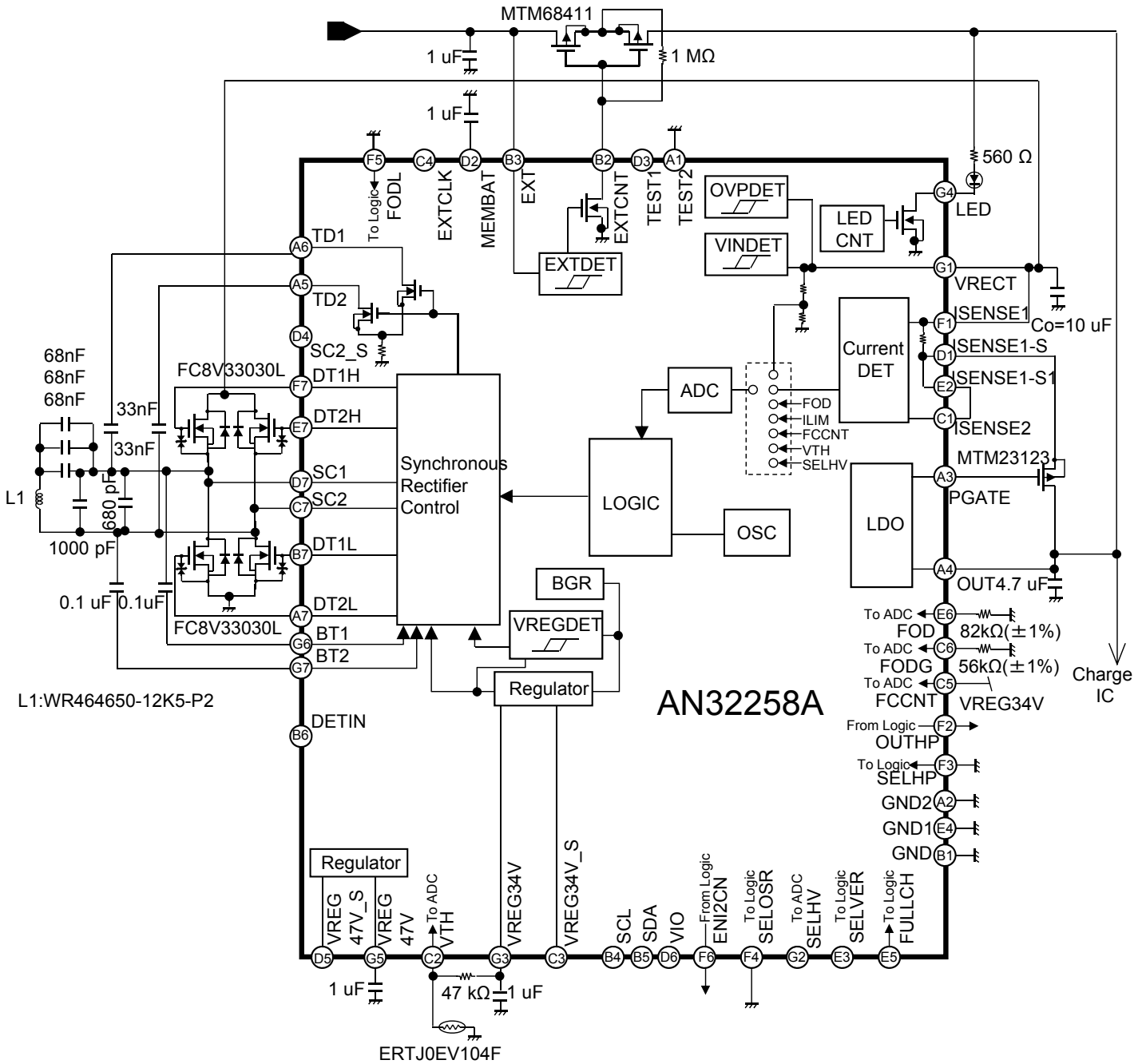

FUNCTIONS

AN32258A has the following functions.

No.	Function
1	Full charge control
2	Over current control
3	Foreign object detection
4	Over temperature detection
5	Rectifier voltage control
6	LED display
7	External voltage supply switch

1. Full Charge Control

AN32258A has two ways to detect full-charge.

1-1. Switch ON/OFF externally : FULLCH (Pin E5)

AN32258A recognizes an input of high level to FULLCH as full-charge detected and an input of low level as full-charge not detected. When full-charge is detected, a Qi protocol of End Power Transfer Packet will be sent to Tx. The Tx will then stop the power transmission, and the output of AN32258A will shutdown.

Keep the high level to FULLCH for longer than 50μs for full-charge detection. Change it to low level to restart charging. When this function with FULLCH is not needed, connect the pin to GND.

*Time to resume power transmission depends on the Tx. When NN32251A is used, it will take 15 minutes to restart power transmission after full-charge is detected. Notice that the charge may start and stop repeatedly, if the Tx does not have sufficient time to resume power transmission.

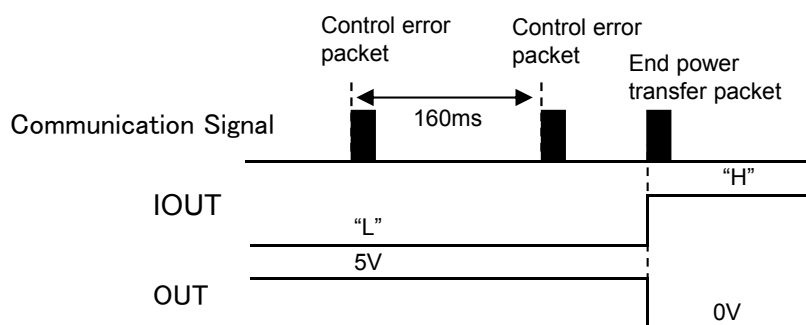

Figure A-1. Full Charge Detection by FULLCH

FUNCTIONS (Continued)

1-2. Control by output current: FCCNT (Pin C5)

When charging current becomes less than the value set at FCCNT (Pin C5), the power transmission stops as full charge. The threshold is determined by a pull-down resistor connected at this pin. For example, when a resistor of 100kohm is used, decreasing output current to less than 80mA will shutdown the LDO, and also data is sent to Tx to stop power transmission. The data to transmit is defined in Qi and called End Power Transfer packet. The current detection starts 5 seconds after power transmission starts.

Connect this pin to VREG34V, when this full-charge detection is not needed. When FULLCH pin is connected to high level to be activated, FCCNT will not control the full-charge detection. This function does not work for FCCNT voltage of over 3V. Also, note that the minimum threshold is 40mA.

*Time to resume power transmission depends on the Tx. When NN32251A is used, it will take 15 minutes to restart power transmission after full-charge is detected. Notice that the charge may start and stop repeatedly, if the Tx does not have sufficient time to resume power transmission.

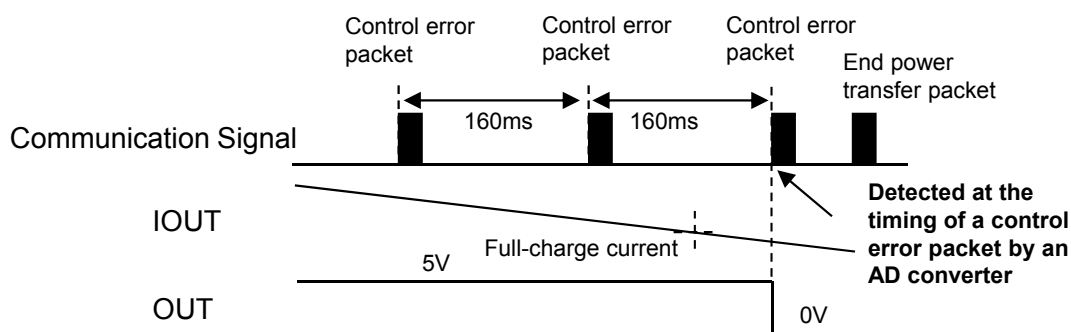
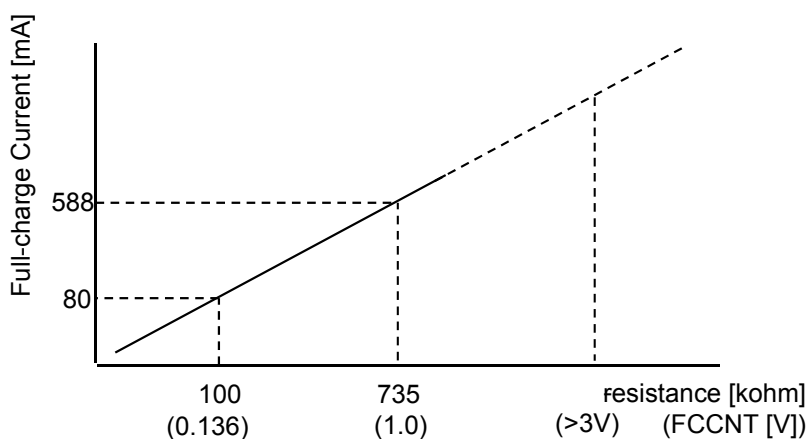

Figure A-2. Full Charge Detection by FCCNT



FigureA-3. Full charge detecting current is controlled by a resistor connected to FCCNT.

$$\text{Full-charge Current [mA]} = 2000/3.4 \times 0.00000136 \times R[\Omega]$$

FUNCTIONS (Continued)

2.Current Limit Control

When the output current exceeds the threshold value, AN32258A will shutdown the output.

When this over-current is detected, data is sent to Tx to stop power transmission. The data to transmit to Tx is End Power Transfer packet defined in Qi, and right after the Tx receives the data, it stops its power transmission. The threshold value is about 1.5A.

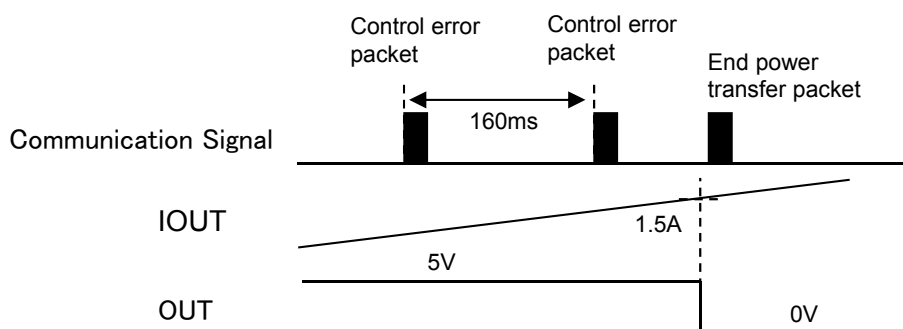

Figure A-4. Timing characteristics for current limit control

3.Foreign Object Detection

AN32258A has a foreign object detection complying with the WPC 1.1 specification. The specification defines a foreign object when the difference between transmitted power and received power is large. The Tx measures the power difference and stops power transmission when the difference is large.

The value of Received Power (address 04h) can be adjusted by the following three pins.

3-1. Offset Control : FOD (Pin E6)

Connect a pull-down resistor at FOD pin to adjust the offset level of received power sent to the Tx.

For example, a pull-down resistor of 100kohm will set the offset to be zero. This function does not work for FOD voltage of over 3V.

If this function is not needed, connect the FOD pin to VREG34V.

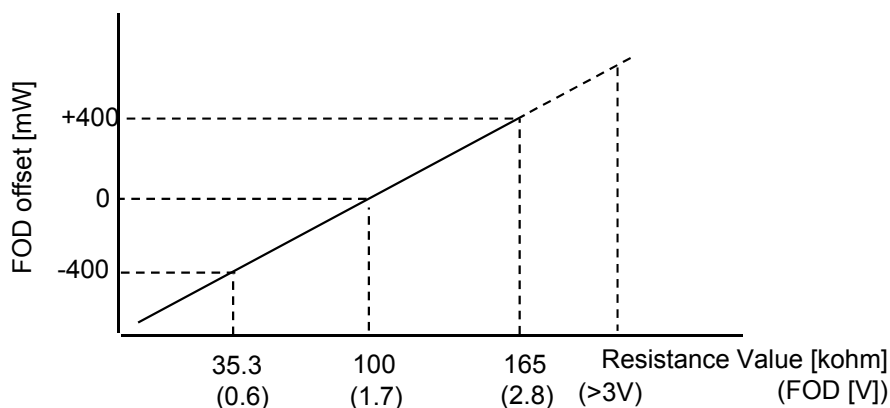

Figure A-5. FOD offset is controlled by a resistor connected to FOD pin

FUNCTIONS (Continued)

3.Foreign Object Detection (Continued)

3-2. Offset Control for low current : FOD (Pin F5)

An offset can be introduced to the received power for low current at IOOUT.

Set the FODL pin to either logical high or low.

Low (GND) : No offset

High (over 1.6V) : Offset added (IOOUT < ~125mA)

3-3. Gain control : FODG (Pin C6)

The gain of received power can be adjusted by a pull-down resistor connected at this pin. The resistance can be varied from 10k ohms to 180k ohms as the following figure shows.

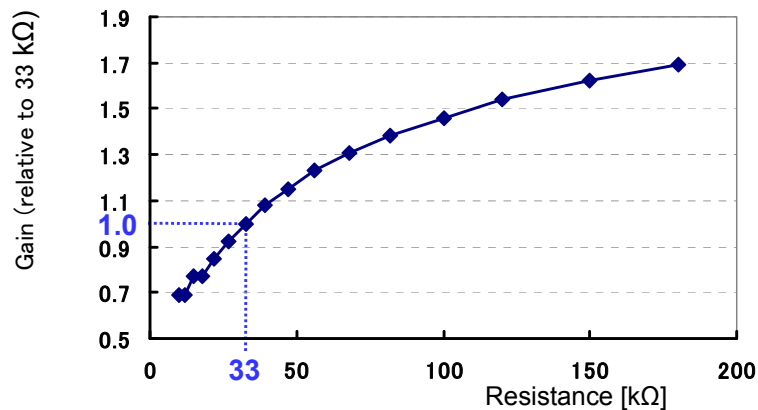

Figure A-5-1. The relationship between received power gain and pull-down resistance at FODG

4. Over Temperature Detection : VTH (Pin C2)

A thermistor, ERTJ0EV104F recommended, can be connected to VTH pin. Connecting a resistor from VTH to VREG34V will fix the threshold temperature. For example, a 47kΩ resistor yields a threshold of 60 °C.

Refer to TYPICAL CHARACTERISTICS section for more detail.

Connect to VREEG34V (G3) if thermistors are not in use.

FUNCTIONS (Continued)

5. Rectifier Voltage Control

AN32258A controls the rectifier output (VRECT) depending on the current value (IOUT). The following figure shows the change of VRECT due to IOUT. Note that the changed timing in increasing IOUT is different from that in decreasing IOUT.

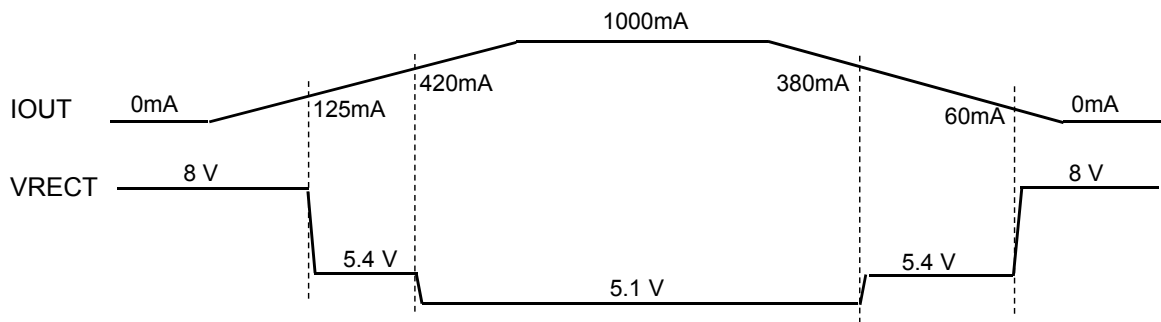

Figure A-8. VRECT changes by the value of output current.
(Values shown are for reference.)

FUNCTIONS (Continued)

6. LED Display : LED (Pin G4)

AN32258A has LED driver. Connect an LED and a resistor in series from OUT to LED pins.
The LED turns on and off as the following figure shows.

Table A-1. LED Display

Status	Display
	LED
Standby	OFF
Charging	ON
Full-charge detected	OFF
External power supply detected	OFF
Over-current detected	OFF
Over-temperature detected	OFF

7. External Voltage Supply Switch : EXT (Pin B3), EXTCNT (Pin B2)

The voltage supply to a charger can be switched from AN32258A to some external voltage supply, such as USB. For this function to work, introduce an external voltage to EXT pin. When EXT becomes larger than 4.2V, the external MOSFET switch will turn on to output the external voltage in direct. Also, End Power Transfer Packet is sent to Tx to stop power transmission at the same time.

If the external voltage supply becomes lower than 3.8V, the external MOSFET switch will turn off. Then, Tx will resume power transmission, and AN32258A will start to output at the LDO. Refer to the circuit diagram before FUNCTIONS section for the configuration at EXT pin.

EVALUATION RESULTS

Evaluation Circuit Diagram

Conditions :

EXT (B3) : 5V input

FCCNT (C5): Pulled down with a 100kΩ resistor for section 3, and connected to REG34V for other evaluations.

FULLCH (E5) : Voltage swept for section 3, and connected to GND for other evaluations.

Coil (L1): 13.94μH (TDK: WR464650-12K5-P2)

Charger: NN32251AA_EVM(A11) (except section 12)

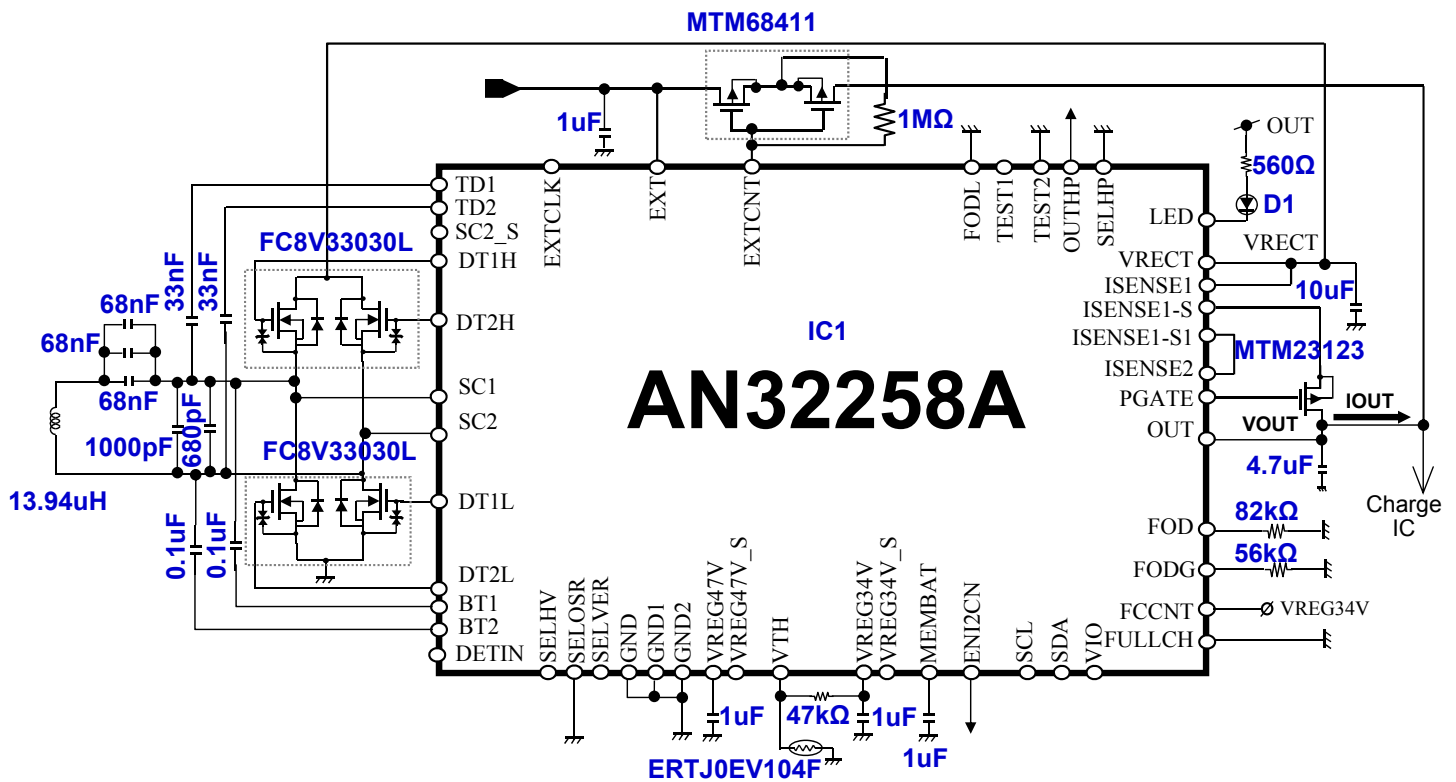

Figure B-1. AN32258A Evaluation Circuit

TYPICAL CHARACTERISTICS (Continued)

1. Output Voltage Characteristics

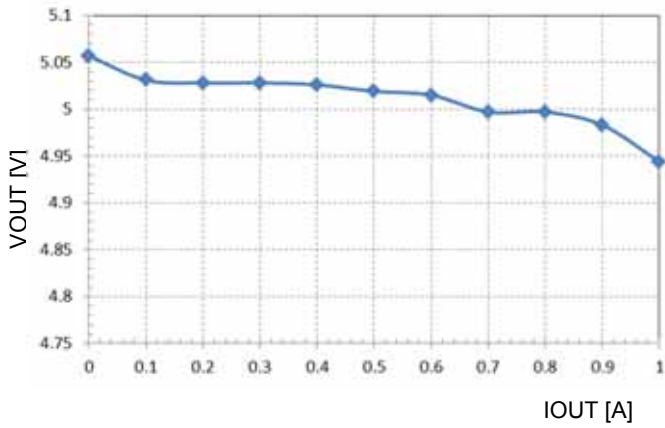

Figure B-2 Output Voltage vs Output Current

2. VRECT Voltage Characteristics

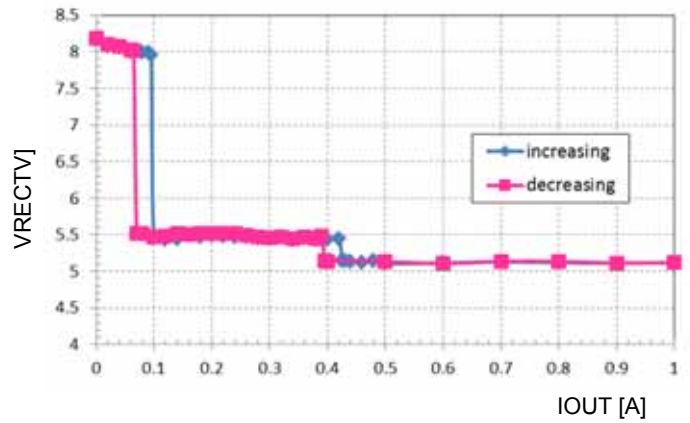

Figure B-3 VRECT Voltage vs Output Current

3. Full-Charge Characteristics

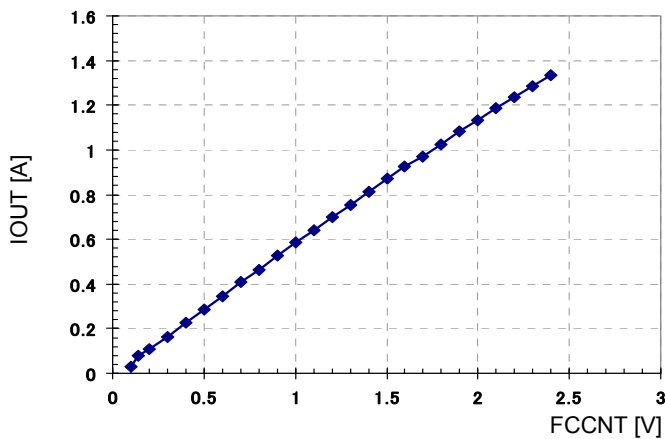

Figure B-4 Full-Charge Detecting Current vs FCCNT Voltage with a 100kΩ Resistor Connected

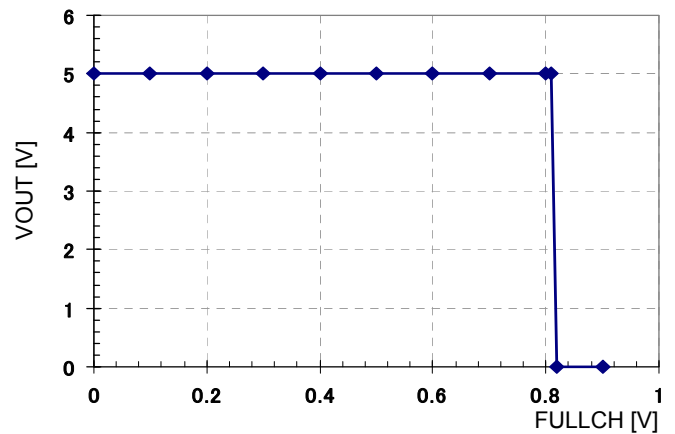

Figure B-5 Output Voltage vs FULLCH Level

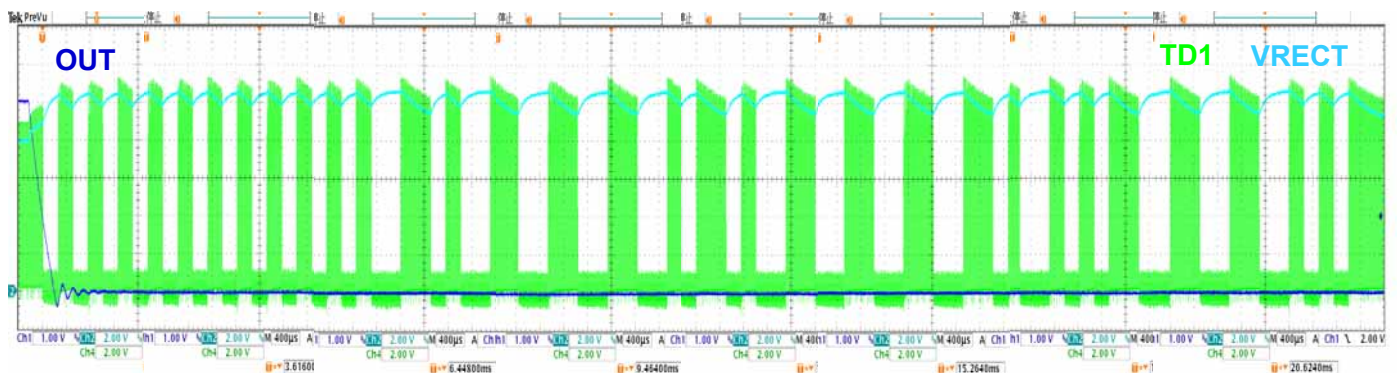

Figure B-6 Received Signal Characteristics after a Full-Charge Detection

*After the output voltage becomes zero, an End Power Transfer Packet is sent.

TYPICAL CHARACTERISTICS (Continued)

4. Over Current Protection Characteristics

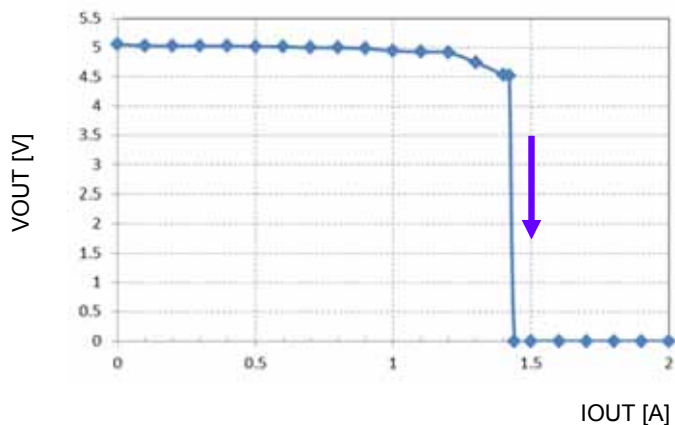

Figure B-7 VOUT vs IOU

5. Temperature Detection Characteristics

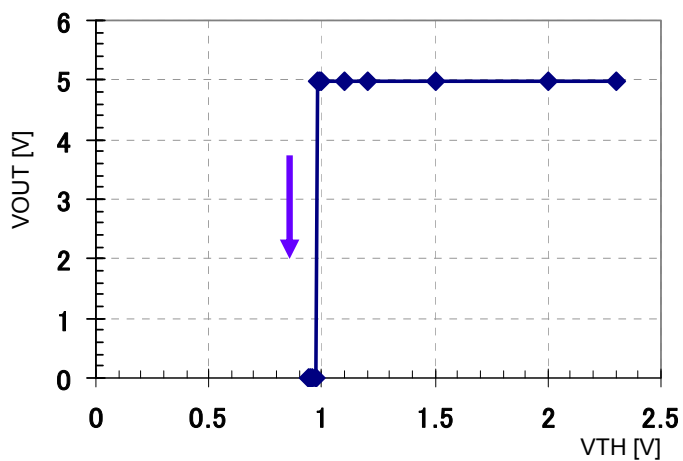

Figure B-8 Output Voltage vs VTH

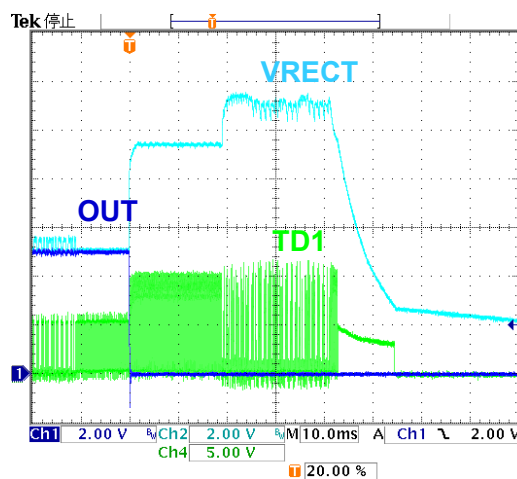

Figure B-9 Received Signal Characteristics after a Temperature Detection

*Conditions : IOU =500mA
 The power transmission from Tx stops due to temperature detection (VTH).

TYPICAL CHARACTERISTICS (Continued)

6. Over Voltage Protection Characteristics

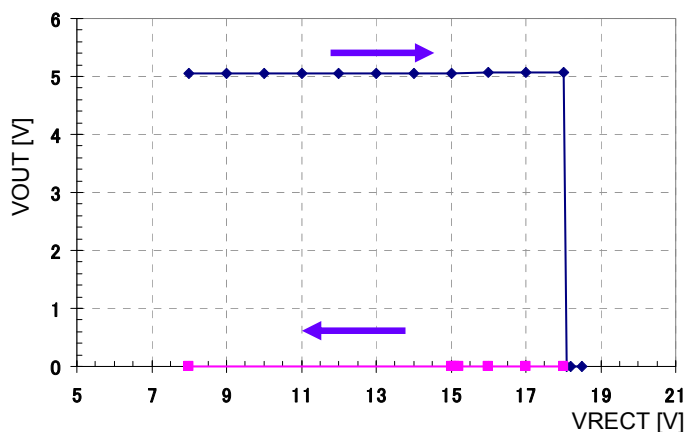

Figure B-10 VOUT vs VRECT by OVP

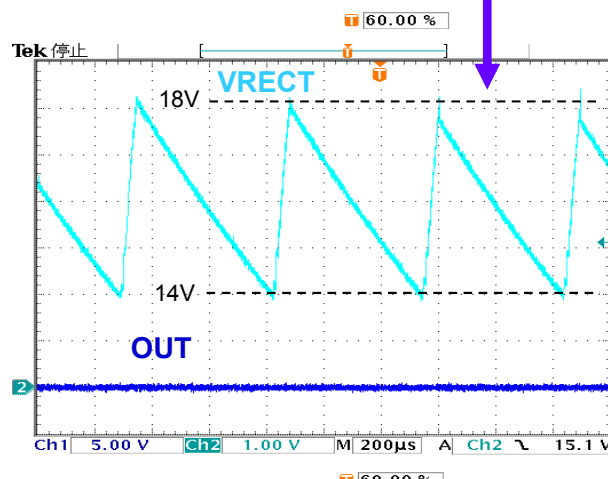
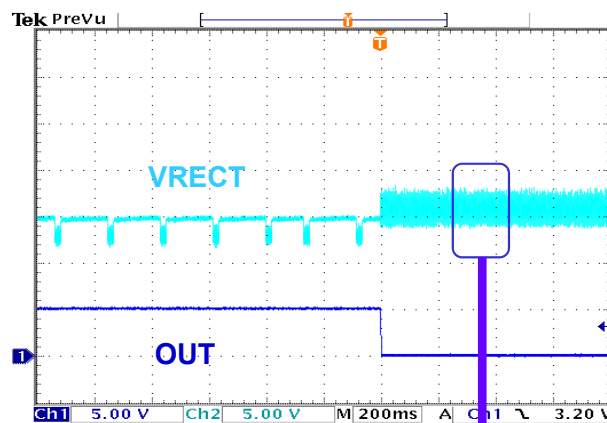

Figure B-11 Output Voltage Response by OVP

7. Foreign Object Detection Characteristics

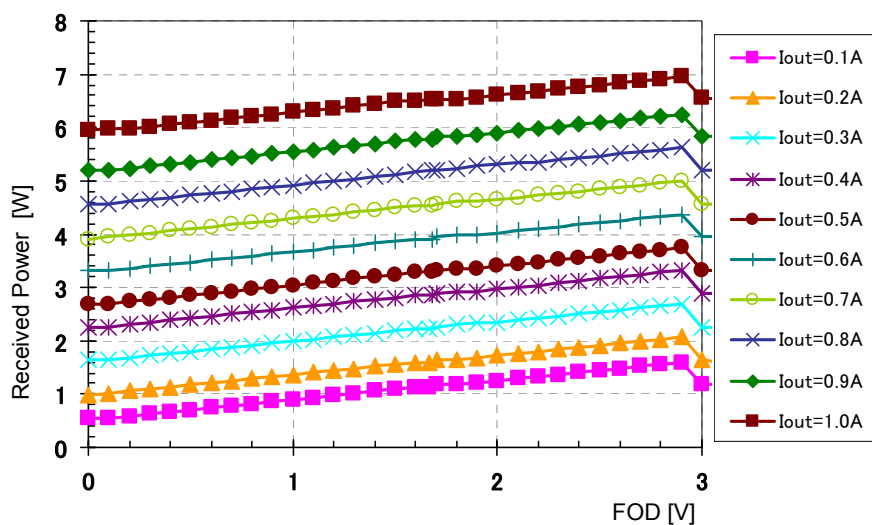

Figure B-12 Received Power vs FOD Voltage

*Received Power = (RPWR[7:0] / 128) × (Maximum Power / 2) × 10Power Class W

TYPICAL CHARACTERISTICS (Continued)

8. External Power Supply Switch Characteristics

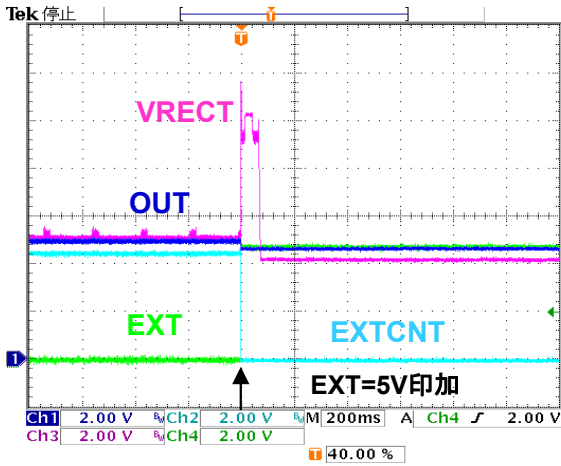

Figure B-13 Voltage when an External Power is Inputted during Normal Wireless Power Transmission
 *Condition : IOUT=500mA

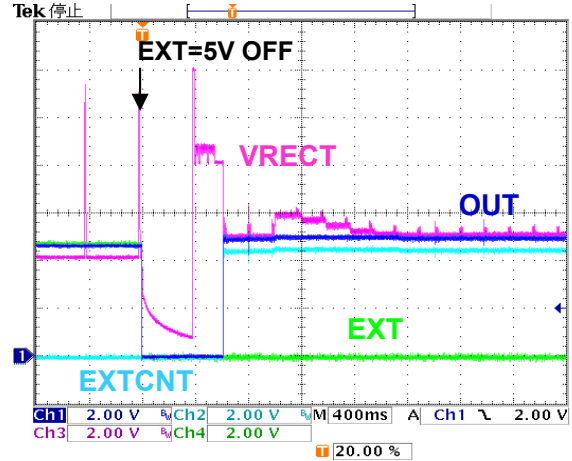

Figure B-14 Normal Power Transmission Resumes after the External Power Turns Off.
 *Condition : IOUT=500mA

9. Start-up Characteristics

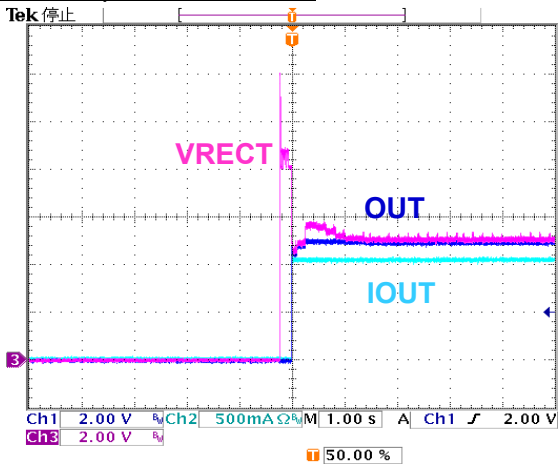

Figure B-15 Characteristics of Starting Wireless Power Transmission
 *Condition : IOUT=1000mA

10. Communication Packet Configuration

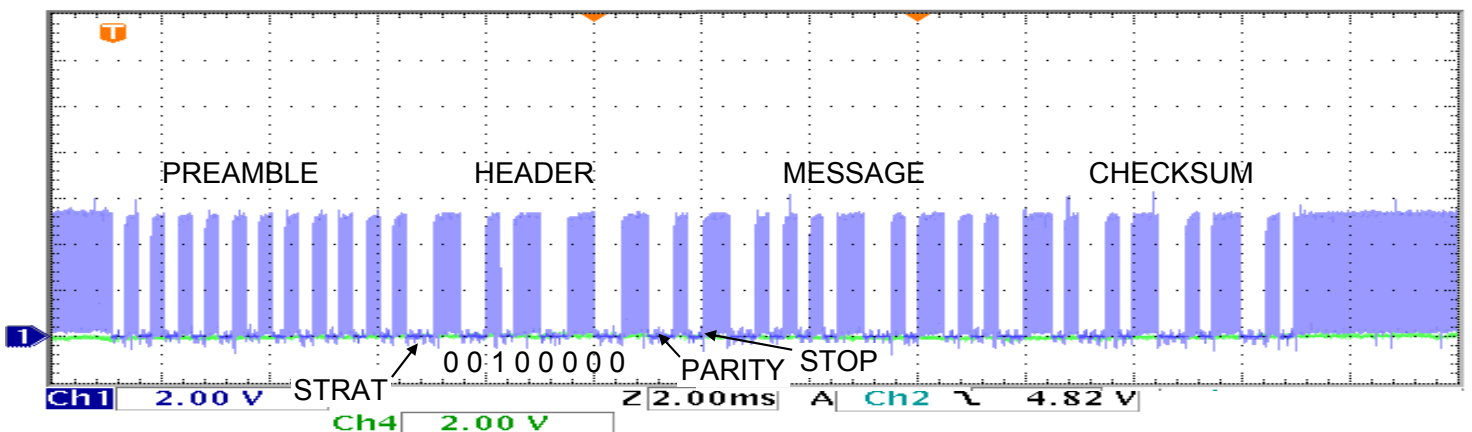

Figure B-16 Rx Communication Packet Structure