



Chipsmall Limited consists of a professional team with an average of over 10 year of expertise in the distribution of electronic components. Based in Hongkong, we have already established firm and mutual-benefit business relationships with customers from,Europe,America and south Asia,supplying obsolete and hard-to-find components to meet their specific needs.

With the principle of “Quality Parts,Customers Priority,Honest Operation,and Considerate Service”,our business mainly focus on the distribution of electronic components. Line cards we deal with include Microchip,ALPS,ROHM,Xilinx,Pulse,ON,Everlight and Freescale. Main products comprise IC,Modules,Potentiometer,IC Socket,Relay,Connector.Our parts cover such applications as commercial,industrial, and automotives areas.

We are looking forward to setting up business relationship with you and hope to provide you with the best service and solution. Let us make a better world for our industry!



## Contact us

Tel: +86-755-8981 8866 Fax: +86-755-8427 6832

Email & Skype: info@chipsmall.com Web: www.chipsmall.com

Address: A1208, Overseas Decoration Building, #122 Zhenhua RD., Futian, Shenzhen, China



# ANT-916-PML-ccc

## Data Sheet

### Product Description

Designed for permanent attachment, the PML ½-wave whip tilts 180 degrees and delivers outstanding performance in a cost-effective package. An internal counterpoise eliminates external ground plane dependence and maximizes performance. The antenna is attached by placing its base through a ¼" (6.35 mm) hole in the product and securing it with a nut or by threading it into a PEM-style insert. This method of attachment is highly secure and saves the cost of an antenna connector. The PML attaches to a PCB or connector via 12" (30.48 cm) of RG-178 coax cable. It is also available with 1.32 mm coax cable terminated with a U.FL/MHF compatible connector. This saves the labor of adding a connector while using one that is small enough to fit through the antenna's mounting hole. Custom lengths and terminations are available by special order.

### Features

- Cost-effective
- Internal counterpoise
- Tilts 180 degrees
- Outstanding performance
- Omni-directional pattern
- Low VSWR
- Integral 12" (30.48 cm) RG-178 coax cable or 1.32 mm coax (U.FL)

### Electrical Specifications

Center Frequency:	916MHz
Recom. Freq. Range:	881-951MHz
Bandwidth:	70MHz
Wavelength:	½-wave
VSWR:	≤ 1.9 typical
Peak Gain:	-0.4dBi max
Impedance:	50-ohms
Cable:	12" (30.48 cm) RG-178 or 1.32 mm coax (U.FL)
Connection:	Straight-cut or U.FL/MHF
Oper. Temp. Range:	-40°C to +90°C

Electrical specifications and plots measured on 10.16 cm x 10.16 cm (4.00" x 4.00") reference ground plane

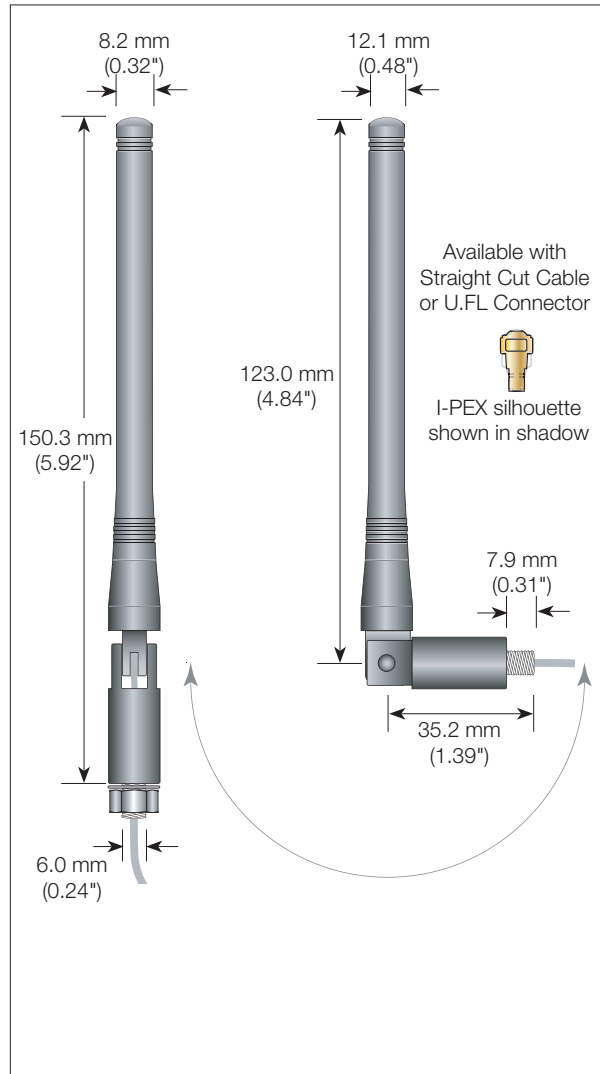

### Ordering Information

ANT-916-PML (with straight cut RG-178 coax)  
ANT-916-PML-UFL (with U.FL/MHF compatible connector and 1.32mm coax)

## VSWR Graph

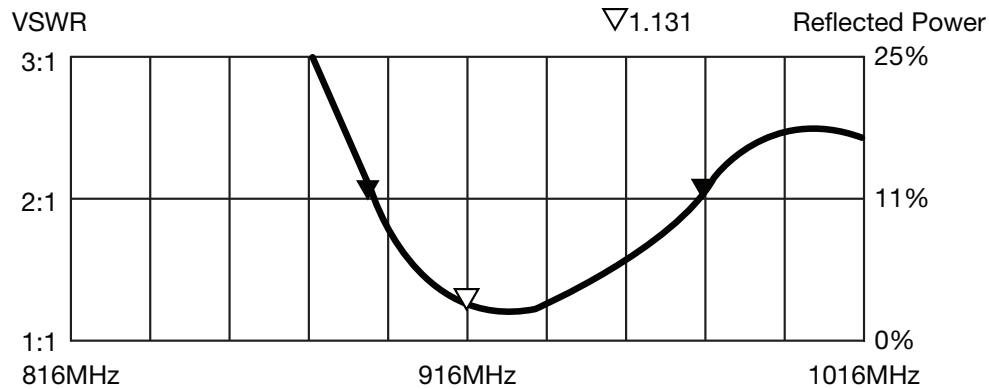

### What is VSWR?

The Voltage Standing Wave Ratio (VSWR) is a measurement of how well an antenna is matched to a source impedance, typically 50-ohms. It is calculated by measuring the voltage wave that is headed toward the load versus the voltage wave that is reflected back from the load. A perfect match has a VSWR of 1:1. The higher the first number, the worse the match, and the more inefficient the system. Since a perfect match cannot ever be obtained, some benchmark for performance needs to be set. In the case of antenna VSWR, this is usually 2:1. At this point, 88.9% of the energy sent to the antenna by the transmitter is radiated into free space and 11.1% is either reflected back into the source or lost as heat on the structure of the antenna. In the other direction, 88.9% of the energy recovered by the antenna is transferred into the receiver. As a side note, since the “:1” is always implied, many data sheets will remove it and just display the first number.

### How to Read a VSWR Graph

VSWR is usually displayed graphically versus frequency. The lowest point on the graph is the antenna’s operational center frequency. In most cases, this is different than the designed center frequency due to fabrication tolerances. The VSWR at that point denotes how close to 50-ohms the antenna gets. Linx specifies the recommended bandwidth as the range where the typical antenna VSWR is less than 2:1.