



Chipsmall Limited consists of a professional team with an average of over 10 year of expertise in the distribution of electronic components. Based in Hongkong, we have already established firm and mutual-benefit business relationships with customers from,Europe,America and south Asia,supplying obsolete and hard-to-find components to meet their specific needs.

With the principle of “Quality Parts,Customers Priority,Honest Operation,and Considerate Service”,our business mainly focus on the distribution of electronic components. Line cards we deal with include Microchip,ALPS,ROHM,Xilinx,Pulse,ON,Everlight and Freescale. Main products comprise IC,Modules,Potentiometer,IC Socket,Relay,Connector.Our parts cover such applications as commercial,industrial, and automotives areas.

We are looking forward to setting up business relationship with you and hope to provide you with the best service and solution. Let us make a better world for our industry!



Contact us

Tel: +86-755-8981 8866 Fax: +86-755-8427 6832

Email & Skype: info@chipsmall.com Web: www.chipsmall.com

Address: A1208, Overseas Decoration Building, #122 Zhenhua RD., Futian, Shenzhen, China



ANT-LTE-HDP-2000-SMA

Data Sheet



Product Description

The Linx HDP Series antenna is a highly versatile antenna, offering high performance in a wide range of applications as well as an industrial ruggedness at a commercial price point. These durable, low profile, IP67, UV, and extended temperature rated robust antennas mount to non-conductive surfaces with an integrated PSA adhesive patch and have a horizontal cable egress. With two meters of low loss cable, the HDP Series antenna can be located remotely from the radio and positioned for optimal performance. The HDP Series offers a very rugged solution at a fraction of the cost of competitive options.

The HDP Series LTE antenna supports all common LTE frequency bands making it ideal for LTE, CAT-M1 and NB-IOT applications as well as 2G and 3G systems. It is easily customized with different cable lengths and connectors for volume orders. Contact Linx for details.



Features

- Covers all common 4G/3G/2G LTE bands
- Fully weatherized - UV protected, IP67, wide temperature range
- Low Loss cable for better RF performance at higher frequency bands

Ordering Information

ANT-LTE-HDP-2000-SMA

Electrical Specifications

Electrical Specifications				
Parameter	LTE/ GSM850/ GSM900	DCS/ PCS/ UMTS1	LTE 2300	LTE 2600
Recommended Frequency Range	698 – 960	1710 – 2170	2300 – 2400	2500 – 2700
VSWR	<1.75:1	<1.35:1	<1.3:1	<1.25:1
Peak Gain	3.5dBi	4.5dBi	3.25dBi	4.5dBi
Average Gain	-1.5dBi	-3.75dBi	-4.0dBi	-4.5dBi
Efficiency	65%	45%	40%	35%
Polarization	Linear			
Radiation	Omni-Directional			
Max Power	10W			
Wavelength	½-wave			
Impedance	50-ohms			
Cable	2m of Low Loss RG-174/U			
Connection	SMA Plug (Male)			
Mounting Type	Adhesive			
Weight	42g (1.7oz.)			
Operating Temperature Range	-40°C to +85°C			

Dimensions

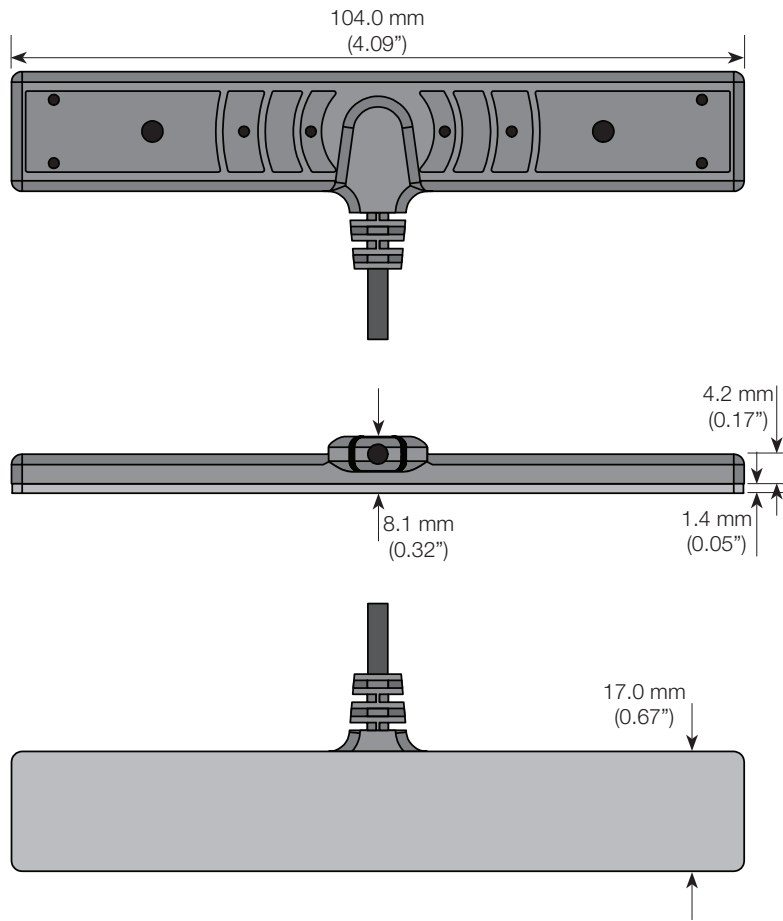

VSWR Graph

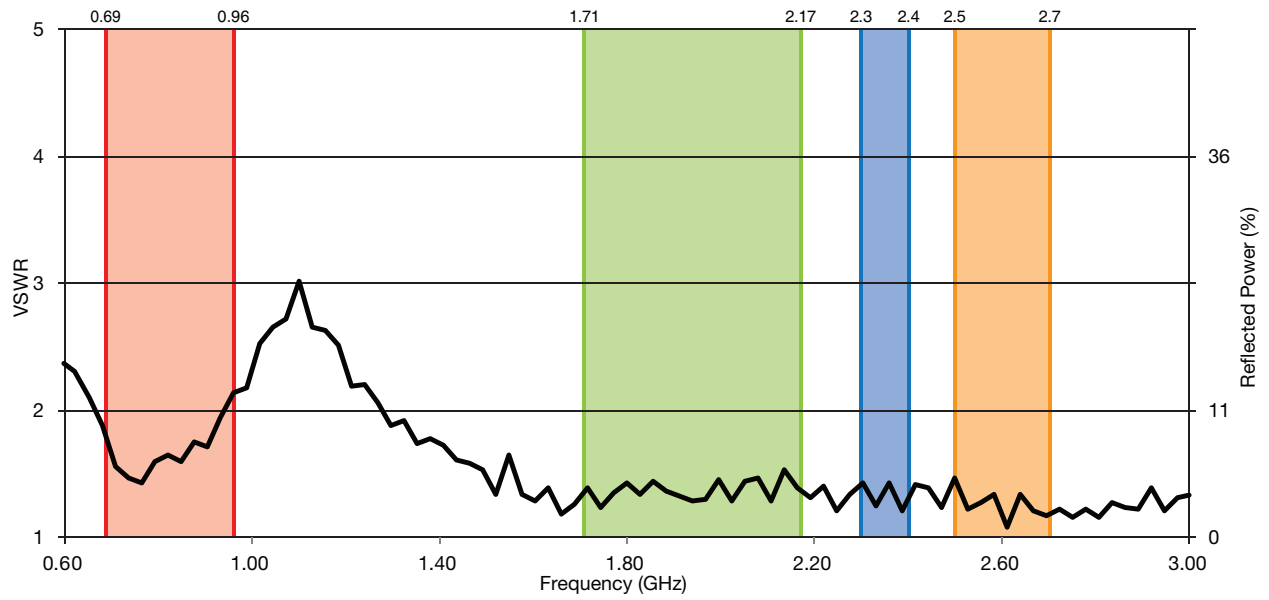

Return Loss

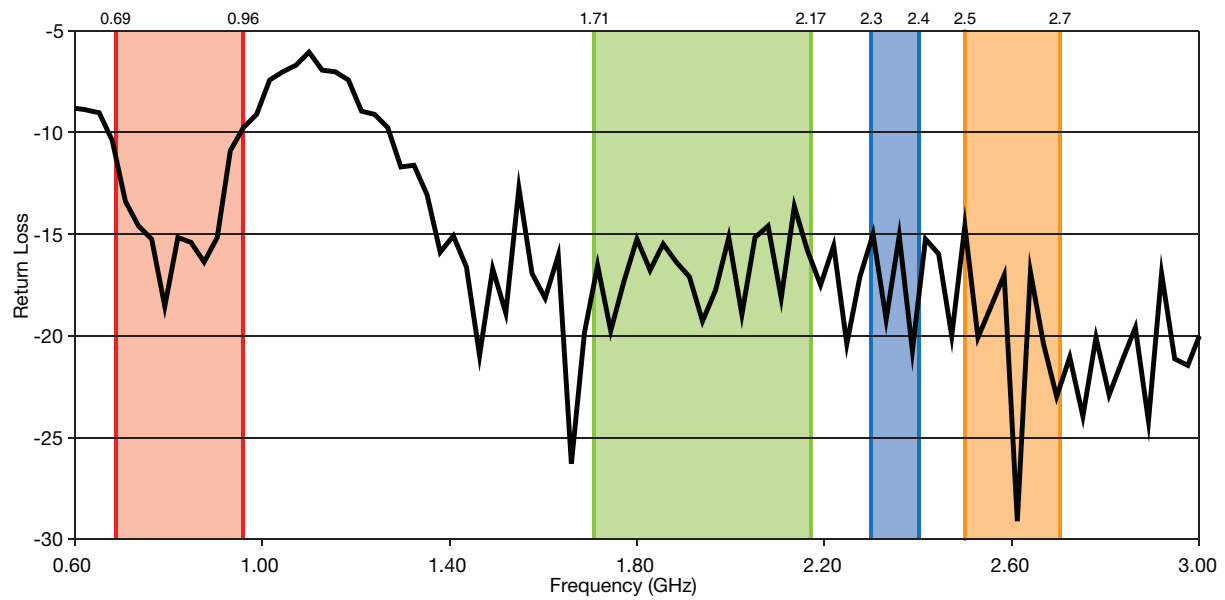

Gain Plots

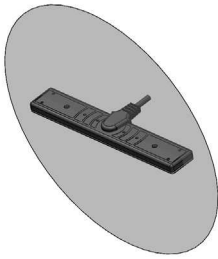

XZ-Plane Gain

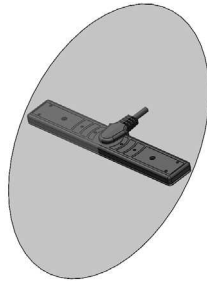

YZ-Plane Gain

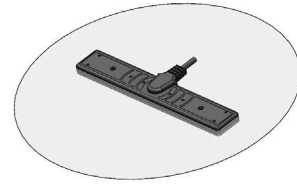

XY-Plane Gain

700 - 960MHz

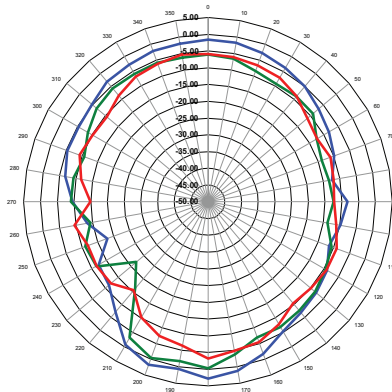

XZ-Plane Gain

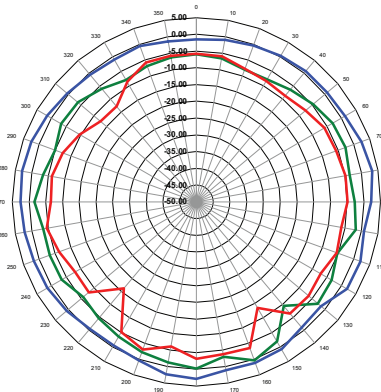

YZ-Plane Gain

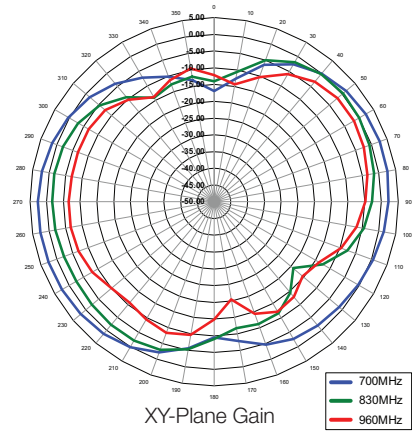

XY-Plane Gain



1710 - 2170MHz

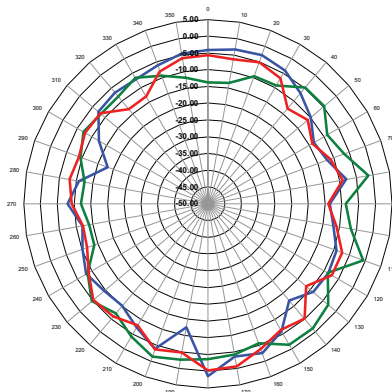

XZ-Plane Gain

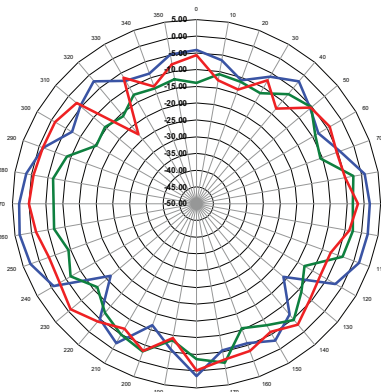

YZ-Plane Gain

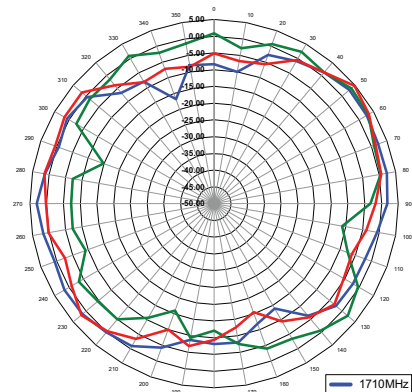

XY-Plane Gain



Gain Plots

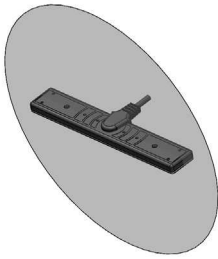

XZ-Plane Gain

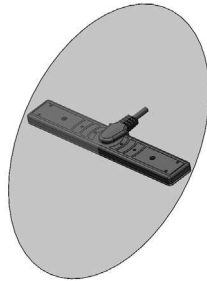

YZ-Plane Gain

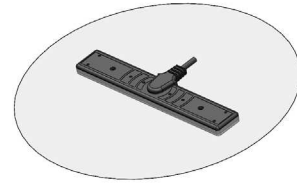

XY-Plane Gain

2300 - 2400MHz

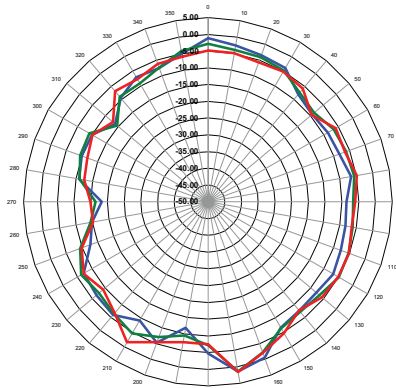

XZ-Plane Gain

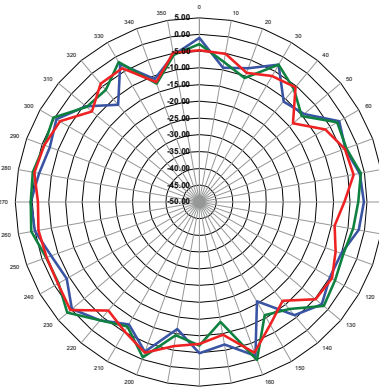

YZ-Plane Gain

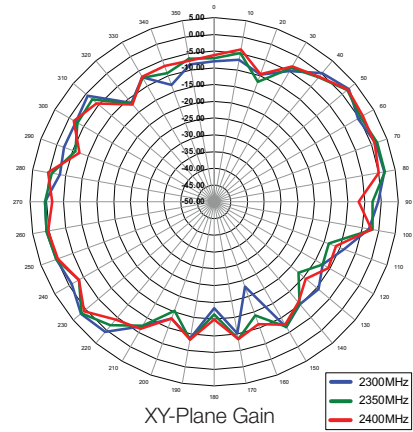

XY-Plane Gain



2500 - 2700MHz

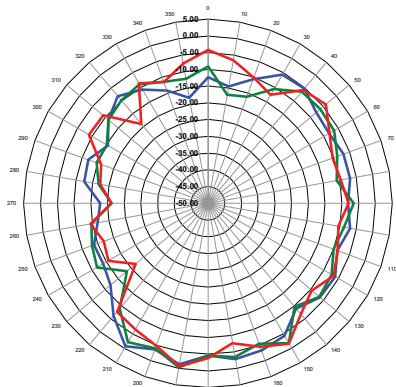

XZ-Plane Gain

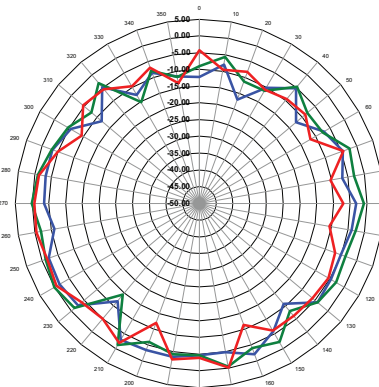

YZ-Plane Gain

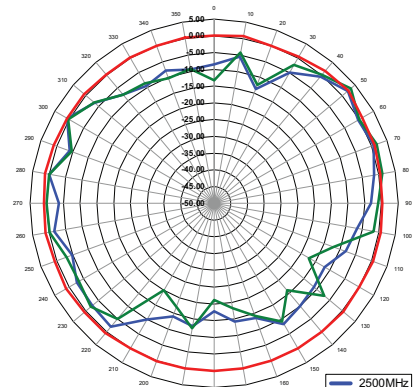

XY-Plane Gain



Peak Gain

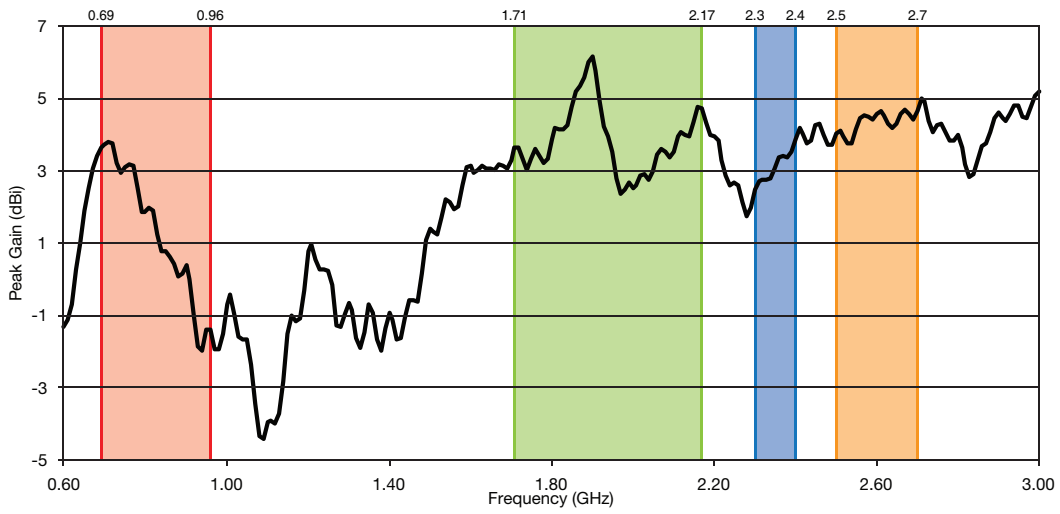

Average Gain

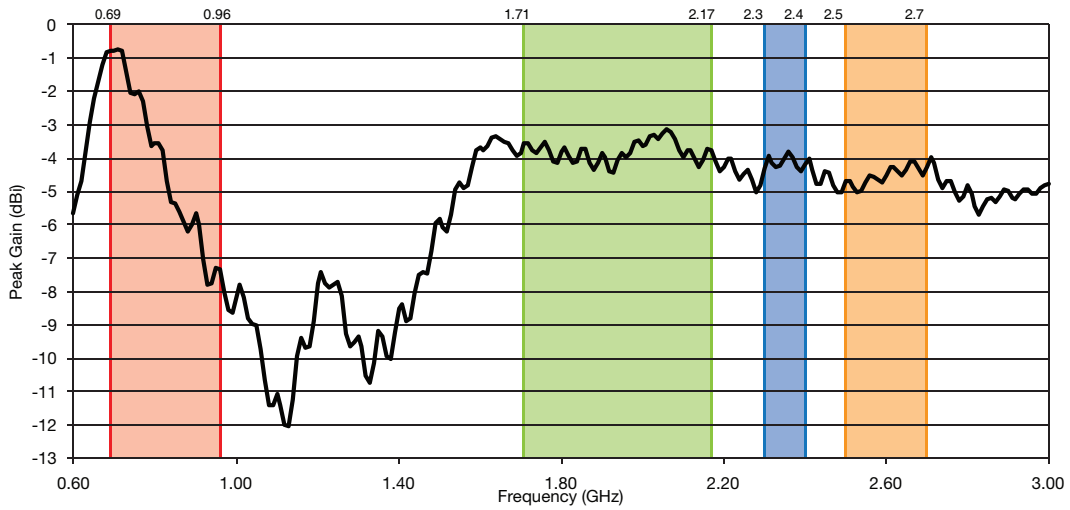

Radiation Efficiency

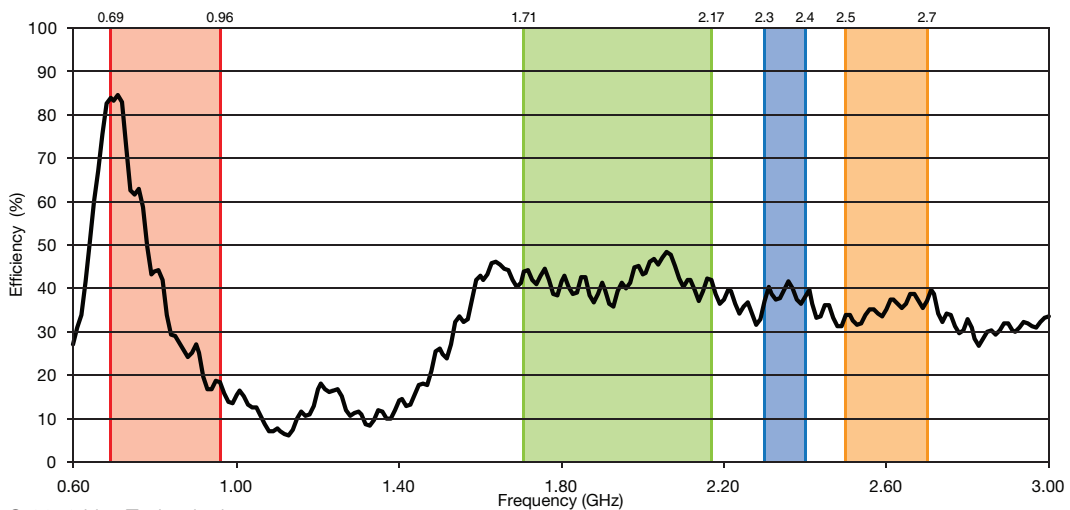

Copyright © 2018 Linx Technologies

159 Ort Lane, Merlin, OR 97532
 Phone: +1 541 471 6256
 Fax: +1 541 471 6251
 www.linxtechnologies.com