



Chipsmall Limited consists of a professional team with an average of over 10 year of expertise in the distribution of electronic components. Based in Hongkong, we have already established firm and mutual-benefit business relationships with customers from,Europe,America and south Asia,supplying obsolete and hard-to-find components to meet their specific needs.

With the principle of “Quality Parts,Customers Priority,Honest Operation,and Considerate Service”,our business mainly focus on the distribution of electronic components. Line cards we deal with include Microchip,ALPS,ROHM,Xilinx,Pulse,ON,Everlight and Freescale. Main products comprise IC,Modules,Potentiometer,IC Socket,Relay,Connector.Our parts cover such applications as commercial,industrial, and automotives areas.

We are looking forward to setting up business relationship with you and hope to provide you with the best service and solution. Let us make a better world for our industry!



## Contact us

Tel: +86-755-8981 8866 Fax: +86-755-8427 6832

Email & Skype: info@chipsmall.com Web: www.chipsmall.com

Address: A1208, Overseas Decoration Building, #122 Zhenhua RD., Futian, Shenzhen, China



# Panasonic

LED Line Type  
UV Curing System

Aicure **UD40** SERIES

CE  
Conforming to  
EMC Directive

## LED Line Type A New Era Begins



**The all new controller with a temperature feedback function!**

**Controller  
supporting  
dual head  
joins the lineup**

## UD40 series Feature 1

# Strongest UV Intensity Class in the Industry\*1

\*1 Air-cooled line type LED UV industry

Panasonic original LED provides a UV intensity\*2 of 4,600 mW/cm<sup>2</sup>.

\*2 Wavelength: 385 nm 0.015 mil, Irradiation distance: 10 mm 0.394 in

Types with two different wavelengths (365 nm 0.014 mil and 385 nm 0.015 mil) are available.

### AIR COOLING METHOD

Water cooling equipment is not required since the unit is fan-cooled. Compact equipment makes installation easy.

#### ■ Illumination profile (Example)

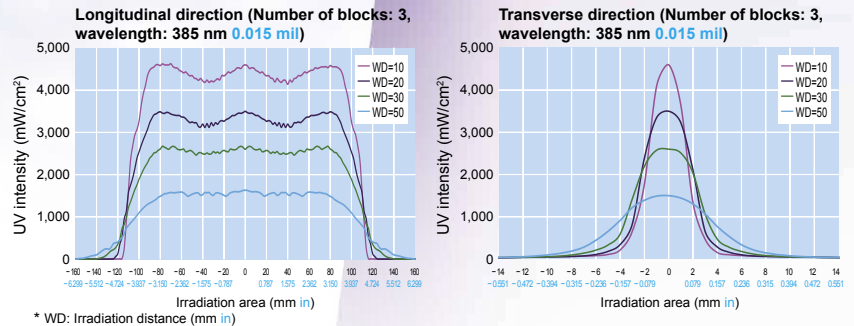

## UD40 series Feature 2

# Multiple Size Variations

Six sizes are available for use in various applications.

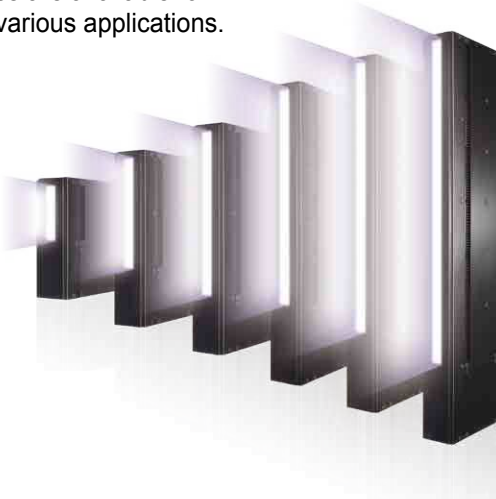

## UD40 series Feature 3

# Compact Size Makes Installation Easier

This compact equipment can be installed in a small space. Provides greater flexibility in choosing the installation location.



## Why is the UV intensity high?

**Reason 1** The LED's capabilities are maximized by its cooling structure and a small size was also achieved.



**Reason 2** It has high light density due to its optical design. Further, it also enables long distance irradiation.

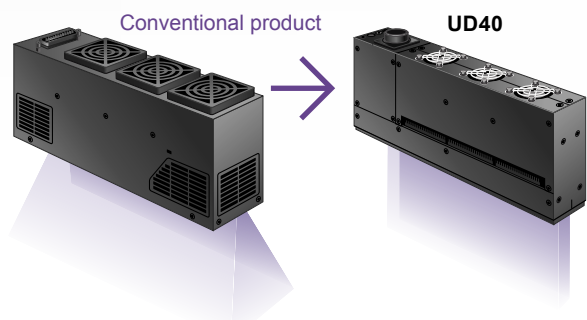

UD40 series Feature 4

# Flexible UV Irradiation Patterns

## Block-level UV intensity control

UV irradiation can be controlled separately for each block in the head. This enables UV irradiation according to the workpiece shape and also reduces power consumption by turning off the LEDs where UV irradiation is not needed.



Dual head irradiation

■ UV irradiation pattern example (6 blocks)



UD40 series Feature 5

# UV Irradiation Stability

No more resin curing defects or adhesion errors  
Temperature feedback control

Provides UV irradiation accuracy within  $\pm 5\%$ .  
(at 80 % UV intensity setting)

Panasonic original

Built-in temperature sensor

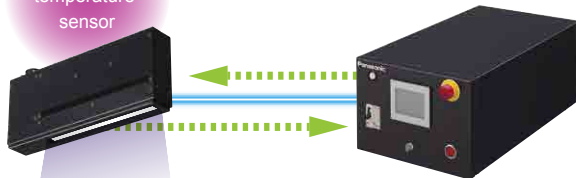

Generally, an increase in LED temperature reduces the UV irradiation output. However, the UD40 series employs a Panasonic original head cooling mechanism to suppress temperature increases. Further, a temperature sensor is built into the head to constantly monitor and feed back temperature information. This has resulted in a superb UV irradiation stability within  $\pm 5\%$  for output up to 80 %. This is ideal for high quality, precise adhesion applications.

■ Typical characteristics (25 °C 77 °F atmosphere)

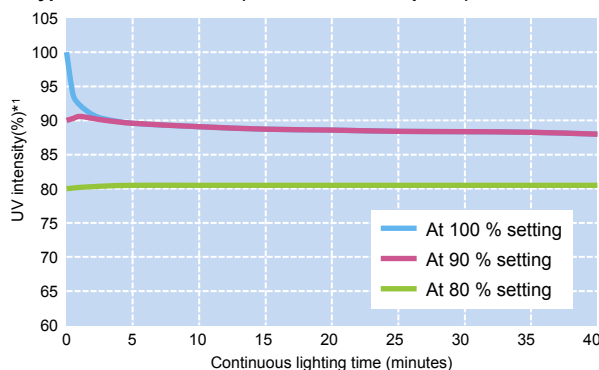

\*1 An output setting of 100 % is indicated as 100.

UD40 series Feature 6

# External Access Control

Control UV irradiation from an external device.  
UV irradiation can be applied only during the required time period.



UV irradiation during the required time period

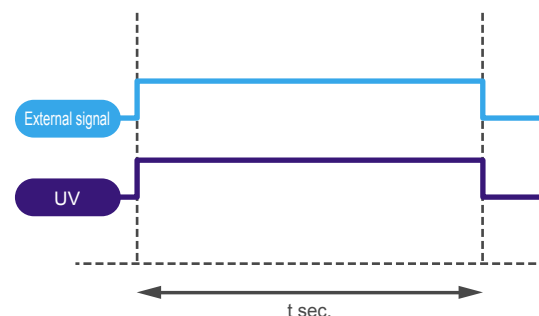

UV irradiation continues during the time period (t sec.) that the external signal is on. UV irradiation stops when the signal is turned off.

UV irradiation from the head can be controlled using a parallel signal from a PLC or other external device.

UD40 series Feature 7

# Operating Time and Temperature Display Functions

## Notification of LED replacement period and abnormal temperature

The number of hours of lighting is counted for each LED block in the head. When a specific number of hours is reached, the LED replacement period is indicated through the controller's external output and panel display. In addition, because the head has a built-in temperature sensor, the LED temperature during operation can be displayed. If an abnormal temperature is detected, the controller sends a warning through its external output and panel display. These functions ensure safety and improve productivity.

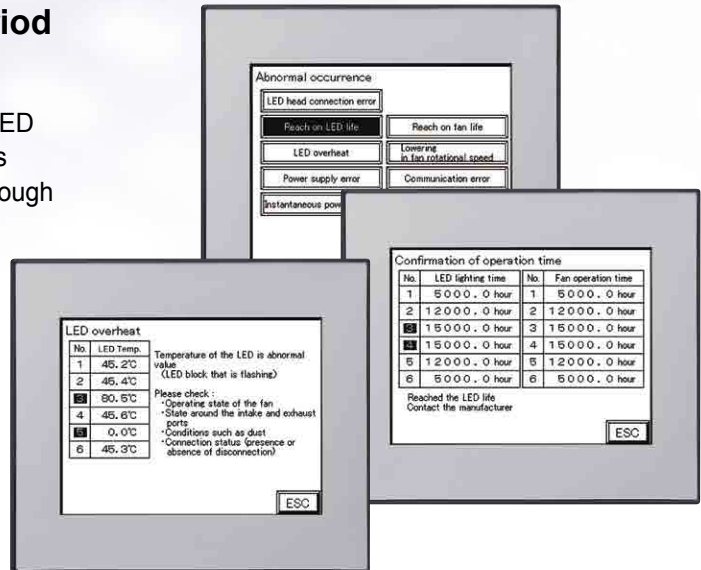

UD40 series Feature 8

## Long-life, Economical LED Type

LED type makes frequent replacement of service parts unnecessary.

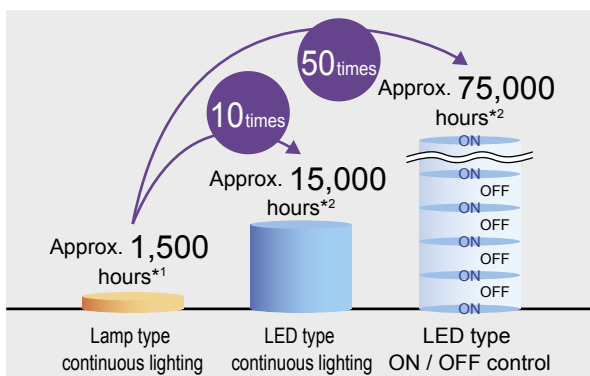

The LED type features extremely long light-source life span compared to the lamp type. As compared to the estimated lamp life span of 1,500 hours\*1, the estimated LED life span is 15,000 hours\*2.

Furthermore, unlike the lamp type that remains on at all times, the LED type can be turned on only when UV irradiation is needed. If the irradiation on/off time ratio is 1:4 (process takt time = 5, irradiation time = 1), this calculates to a life span of approximately 75,000 hours\*2, which can drastically reduce running cost and maintenance man-hours.

\*1 Our straight tube type

\*2 At an ambient operating temperature of +25 °C +77 °F

UD40 series Feature 9

## Low Power Consumption at 100 W per LED Block

Reduces running cost and CO2.

Even when six blocks in a single head are turned on, the maximum power consumption is 650 W (at 200 V AC). This effectively reduces power consumption and CO2 emission. Since less heat is generated than the lamp type, even when the system is used in a small clean room, the increase in room temperature is small. This reduces the power needed for air conditioning.

UD40 series Feature 10

## Eco product compliant with CE, RoHS, etc.



Unlike lamps, LED heads do not contain mercury. UD40 conform to CE Marking, RoHS Directive, and Management Methods for Controlling Pollution by Electronic Information Products (China RoHS), ensuring environmentally safe use. (Please follow the proper industrial waste disposal procedures.)

# Proposal

**Switching from lamp style  
UD40**

**Switching from spot type connection style to line type  
UD40**

Long term light source

Exhaust air duct not required

Space-saving

Power saving

**UV intensity distribution of spot type  
(Typical example)**

ANUJ6180 (standard type) + ANUJ6450S  
(wavelength: 365 nm 0.014 mil, irradiation distance 20 mm 0.787 in)

**UV intensity distribution of line type  
(Typical example)**

UD40  
(Number of blocks: 2, wavelength: 365 nm 0.014 mil, irradiation distance: 30 mm 1.181 in)

- High UV intensity
- Long distance irradiation is also possible
- Improvement in UV intensity uniformity

# Application examples

**Adhesion of touch panel or circuit board**

**Curing of printing on aluminum condenser**

**Curing of hard coat on molded products and cases**

**Curing of coating on molded products and films**

**Curing of coating on building materials and wood work**

**Adhesion of medical equipment**

**Curing (peeling) of dicing tape**

**Curing of PCB coating**

**Adhesion of in-vehicle connector**

**Curing of coating on molded products and films**

## PRODUCT COMPONENTS

### With single head

■ Number of head blocks: 1 to 3

. Head

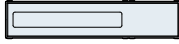

. Controller

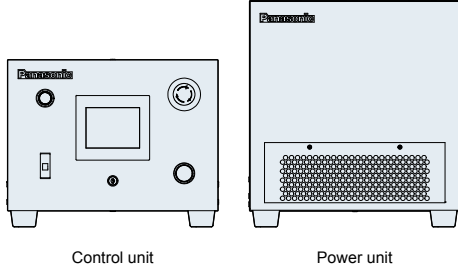

■ Number of head blocks: 4 to 6

. Head



. Controller

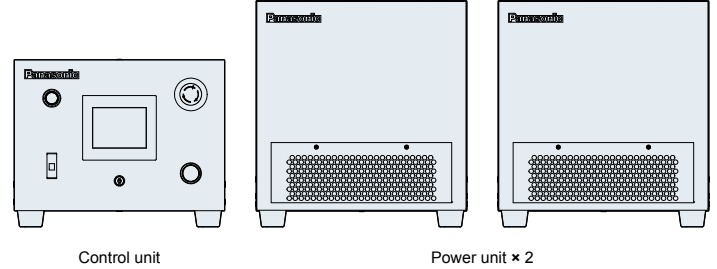

### With dual head

■ Number of blocks in head 1: 1 to 3, number of blocks in head 2: 1 to 3

. Head

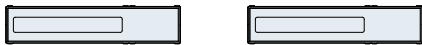

. Controller

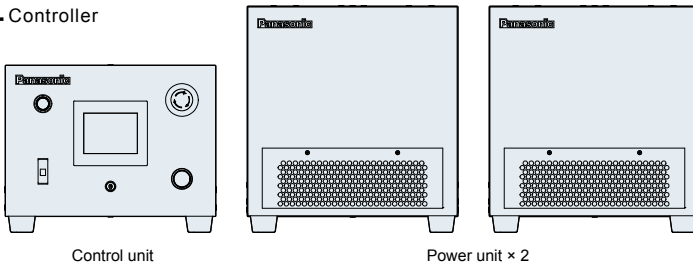

■ Number of blocks in head 1: 1 to 3, number of blocks in head 2: 4 to 6

■ Number of blocks in head 1: 4 to 6, number of blocks in head 2: 1 to 3

. Head



. Controller

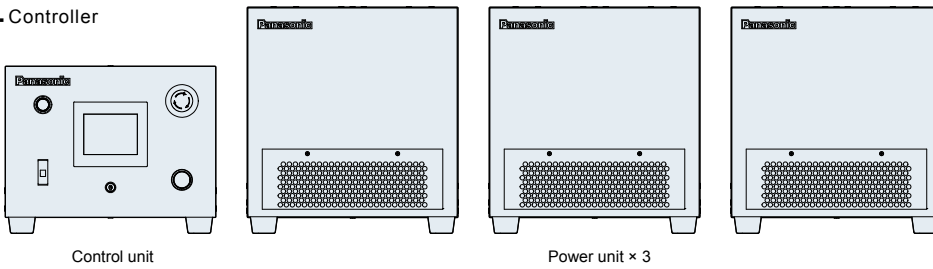

■ Number of blocks in head 1: 4 to 6, number of blocks in head 2: 4 to 6

. Head



. Controller

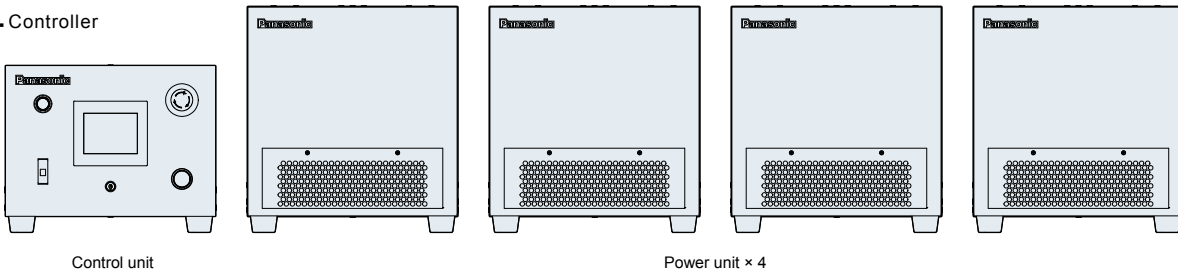

## SPECIFICATIONS

### Common head specifications

Head part No.	Wavelength: 365 nm 0.014 mil	ANUD4A111	ANUD4A211	ANUD4A311	ANUD4A411	ANUD4A511	ANUD4A611
Item	Wavelength: 385 nm 0.015 mil	ANUD4B111	ANUD4B211	ANUD4B311	ANUD4B411	ANUD4B511	ANUD4B611
Number of blocks		1	2	3	4	5	6
Light source		365 nm ±10 nm 0.014 mil ±0.0004 mil / 385 nm ±10 nm 0.015 mil ±0.0004 mil					
Peak irradiation intensity*	Irradiation distance: 10 mm 0.394 in	4,200 mW/cm <sup>2</sup> (Wavelength: 365 nm 0.014 mil) / 4,600 mW/cm <sup>2</sup> (Wavelength: 385 nm 0.015 mil)					
	Irradiation distance: 30 mm 1.181 in	2,300 mW/cm <sup>2</sup> (Wavelength: 365 nm 0.014 mil) / 2,600 mW/cm <sup>2</sup> (Wavelength: 385 nm 0.015 mil)					
Effective irradiation width*	Irradiation distance: 10 mm 0.394 in	36 mm 1.417 in	108 mm 4.252 in	180 mm 7.087 in	252 mm 9.921 in	324 mm 12.756 in	396 mm 15.591 in
	Irradiation distance: 30 mm 1.181 in	16 mm 0.630 in	88 mm 3.465 in	160 mm 6.299 in	232 mm 9.134 in	304 mm 11.968 in	376 mm 14.803 in
Estimated head life expectancy*		15,000 hours (70 % for initial UV intensity)					
Ambient operating temperature / ambient operating humidity		0 to +35 °C +32 to +95 °F / 30 to 85 % RH (no dew condensation or icing allowed)					
Storage temperature / storage humidity		-10 to +60 °C +14 to +140 °F / 30 to 85 % RH (no dew condensation or icing allowed)					
Cooling method		Fan-forced air cooling					
Outer finishing		Matte black painting					

\* Based on our company's measurement standards. Values are typical, but not guaranteed.

### Common controller specifications

Controller part No.	ANUD4S□	
Item		
Input supply voltage	1ϕ 200 - 240 V AC	
Input supply frequency	50 - 60 Hz	
AC inlet	Terminal block (terminal block screw diameter: ϕ4 mm ϕ0.016 in)*1	
No. of irradiation program patterns	32 patterns*2	
Display, setting, operation	Display, setting, operation from the touch screen	
External control	Type	Parallel I/O (D-Sub37*3)
	External input	LED lighting, program selection, LED block individual lighting, local or remote selection, external emergency stop
	External output	Equipment power ON, irradiation preparation complete, irradiating, alert, error, main unit emergency stop
Dimming control*2	50 to 100 % (in increments of 1 %)	
LED temperature feedback	A function that senses the temperature of the LED head section and maintains constant UV intensity	
Ambient operating temperature / ambient operating humidity	0 to +35 °C +32 to +95 °F / 30 to 85 % RH (no dew condensation or icing allowed)	
Storage temperature / storage humidity	-10 to +60 °C +14 to +140 °F / 30 to 85 % RH (no dew condensation or icing allowed)	
Cooling method	Control unit: Fan-less natural air cooling, Power unit: Fan-forced air cooling	
Configuration	Separation of control unit equipped with PLC and power supply for LED lighting	
Outer finishing	Matte black painting	
Accessories	Control unit	Power key, D-Sub37 connector
	Power unit	Signal cable (1 m 3.281 ft), AC connection cable (1 m 3.281 ft), LED head connection cable (5 m 16.404 ft)

\*1 Prepare a separate power supply cable (AC supply cable) with a diameter appropriate for the maximum input current.

\*2 Setting from the touch screen.

\*3 Prepare a separate cable for connecting to the D-Sub37 connector.



## SPECIFICATIONS

### Individual specifications

#### With single head

Number of blocks		1	2	3	4	5	6
Head part No.	Wavelength: 365 nm 0.014 mil	<b>ANUD4A111</b>	<b>ANUD4A211</b>	<b>ANUD4A311</b>	<b>ANUD4A411</b>	<b>ANUD4A511</b>	<b>ANUD4A611</b>
	Wavelength: 385 nm 0.015 mil	<b>ANUD4B111</b>	<b>ANUD4B211</b>	<b>ANUD4B311</b>	<b>ANUD4B411</b>	<b>ANUD4B511</b>	<b>ANUD4B611</b>
Controller part No.		<b>ANUD4S10</b>	<b>ANUD4S20</b>	<b>ANUD4S30</b>	<b>ANUD4S40</b>	<b>ANUD4S50</b>	<b>ANUD4S60</b>
No. of control units		1					
No. of power units		1			2		
Maximum input current		1 A	2 A	3 A	4 A	5 A	6 A
Maximum power consumption		150 W	250 W	350 W	450 W	550 W	650 W
Weight*	Head	1.3 kg approx.	1.8 kg approx.	2.3 kg approx.	3.0 kg approx.	3.5 kg approx.	4.0 kg approx.
	Control unit	10 kg approx.					
	Power unit-1	10 kg approx.	12 kg approx.	14 kg approx.			
	Power unit-2	—			10 kg approx.	12 kg approx.	14 kg approx.

\* Excluding connectors and cables.

#### With dual head (Combinations of [1 to 6 blocks in Head 1] and [1 to 3 blocks in Head 2])

		Number of blocks (Head 1)						
		1	2	3	4	5	6	
Number of blocks (Head 2)	1	Controller part No.	<b>ANUD4S11</b>	<b>ANUD4S21</b>	<b>ANUD4S31</b>	<b>ANUD4S41</b>	<b>ANUD4S51</b>	<b>ANUD4S61</b>
		No. of control units	1					
		No. of power units	2			3		
		Maximum input current	2 A	3 A	4 A	5 A	6 A	7 A
		Maximum power consumption	250 W	350 W	450 W	550 W	650 W	750 W
		Weight*	Head 1	1.3 kg approx.	1.8 kg approx.	2.3 kg approx.	3.0 kg approx.	3.5 kg approx.
	Head 2		1.3 kg approx.					
	Control unit		10 kg approx.					
	Power unit-1		10 kg approx.	12 kg approx.	14 kg approx.			
	Power unit-2		—			10 kg approx.	12 kg approx.	14 kg approx.
	Power unit-3		10 kg approx.					
	2	Controller part No.	<b>ANUD4S12</b>	<b>ANUD4S22</b>	<b>ANUD4S32</b>	<b>ANUD4S42</b>	<b>ANUD4S52</b>	<b>ANUD4S62</b>
		No. of control units	1					
		No. of power units	2			3		
		Maximum input current	3 A	4 A	5 A	6 A	7 A	8 A
		Maximum power consumption	350 W	450 W	550 W	650 W	750 W	850 W
		Weight*	Head 1	1.3 kg approx.	1.8 kg approx.	2.3 kg approx.	3.0 kg approx.	3.5 kg approx.
	Head 2		1.8 kg approx.					
Control unit	10 kg approx.							
Power unit-1	10 kg approx.		12 kg approx.	14 kg approx.				
Power unit-2	—			10 kg approx.	12 kg approx.	14 kg approx.		
Power unit-3	12 kg approx.							
3	Controller part No.	<b>ANUD4S13</b>	<b>ANUD4S23</b>	<b>ANUD4S33</b>	<b>ANUD4S43</b>	<b>ANUD4S53</b>	<b>ANUD4S63</b>	
	No. of control units	1						
	No. of power units	2			3			
	Maximum input current	4 A	5 A	6 A	7 A	8 A	9 A	
	Maximum power consumption	450 W	550 W	650 W	750 W	850 W	950 W	
	Weight*	Head 1	1.3 kg approx.	1.8 kg approx.	2.3 kg approx.	3.0 kg approx.	3.5 kg approx.	4.0 kg approx.
Head 2		2.3 kg approx.						
Control unit		10 kg approx.						
Power unit-1		10 kg approx.	12 kg approx.	14 kg approx.				
Power unit-2		—			10 kg approx.	12 kg approx.	14 kg approx.	
Power unit-3		14 kg approx.						

\* Excluding connectors and cables.

## SPECIFICATIONS

### Individual specifications

With dual head (Combinations of [1 to 6 blocks in Head 1] and [4 to 6 blocks in Head 2])

		Number of blocks (Head 1)							
		1	2	3	4	5	6		
Number of blocks (Head 2)	4	Controller part No.	ANUD4S14	ANUD4S24	ANUD4S34	ANUD4S44	ANUD4S54	ANUD4S64	
		No. of control units	1						
		No. of power units	3			4			
		Maximum input current	5 A	6 A	7 A	8 A	9 A	10 A	
		Maximum power consumption	550 W	650 W	750 W	850 W	950 W	1,050 W	
		Weight*	Head 1	1.3 kg approx.	1.8 kg approx.	2.3 kg approx.	3.0 kg approx.	3.5 kg approx.	4.0 kg approx.
			Head 2	3.0 kg approx.					
			Control unit	10 kg approx.					
	Power unit-1		10 kg approx.	12 kg approx.	14 kg approx.				
	Power unit-2		—			10 kg approx.	12 kg approx.	14 kg approx.	
	Power unit-3		14 kg approx.						
	Power unit-4	10 kg approx.							
	5	Controller part No.	ANUD4S15	ANUD4S25	ANUD4S35	ANUD4S45	ANUD4S55	ANUD4S65	
		No. of control units	1						
		No. of power units	3			4			
		Maximum input current	6 A	7 A	8 A	9 A	10 A	11 A	
		Maximum power consumption	650 W	750 W	850 W	950 W	1,050 W	1,150 W	
		Weight*	Head 1	1.3 kg approx.	1.8 kg approx.	2.3 kg approx.	3.0 kg approx.	3.5 kg approx.	4.0 kg approx.
			Head 2	3.5 kg approx.					
			Control unit	10 kg approx.					
			Power unit-1	10 kg approx.	12 kg approx.	14 kg approx.			
Power unit-2			—			10 kg approx.	12 kg approx.	14 kg approx.	
Power unit-3			14 kg approx.						
Power unit-4		12 kg approx.							
6		Controller part No.	ANUD4S16	ANUD4S26	ANUD4S36	ANUD4S46	ANUD4S56	ANUD4S66	
	No. of control units	1							
	No. of power units	3			4				
	Maximum input current	7 A	8 A	9 A	10 A	11 A	12 A		
	Maximum power consumption	750 W	850 W	950 W	1,050 W	1,150 W	1,250 W		
	Weight*	Head 1	1.3 kg approx.	1.8 kg approx.	2.3 kg approx.	3.0 kg approx.	3.5 kg approx.	4.0 kg approx.	
		Head 2	4.0 kg approx.						
		Control unit	10 kg approx.						
		Power unit-1	10 kg approx.	12 kg approx.	14 kg approx.				
		Power unit-2	—			10 kg approx.	12 kg approx.	14 kg approx.	
		Power unit-3	14 kg approx.						
	Power unit-4	14 kg approx.							

\* Excluding connectors and cables.

## DIMENSIONS (Unit: mm in)

### ANUD4A ANUD4B

Head

■ Number of blocks: 1 to 3

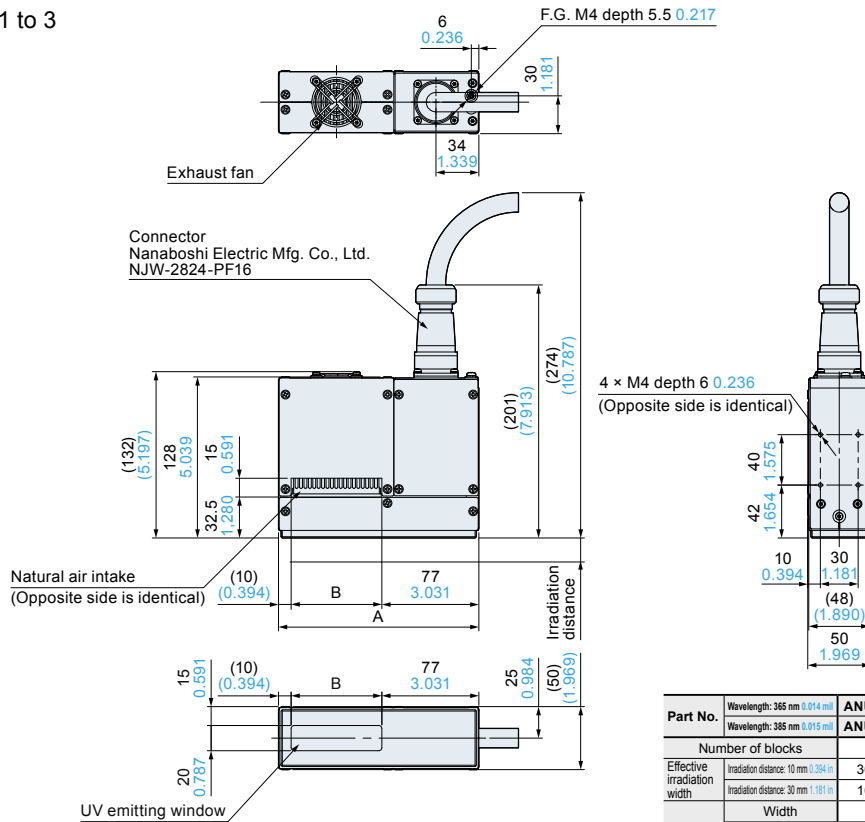

Part No.	Wavelength: 365 nm 0.014 mil	ANUD4A111	ANUD4A211	ANUD4A311
	Wavelength: 385 nm 0.015 mil	ANUD4B111	ANUD4B211	ANUD4B311
Number of blocks		1	2	3
Effective irradiation width	Irradiation distance: 10 mm 0.394 in	36 1.417	108 4.252	180 7.087
	Irradiation distance: 30 mm 1.181 in	16 0.630	88 3.465	160 6.299
External dimensions	Width	50 1.969		
	Height	(142 5.591)		
		(with receptacle, without connector and cable)		
	A (Length)	159 6.260	231 9.094	303 11.929
B	72 2.835	144 5.669	216 8.504	

■ Number of blocks: 4 to 6

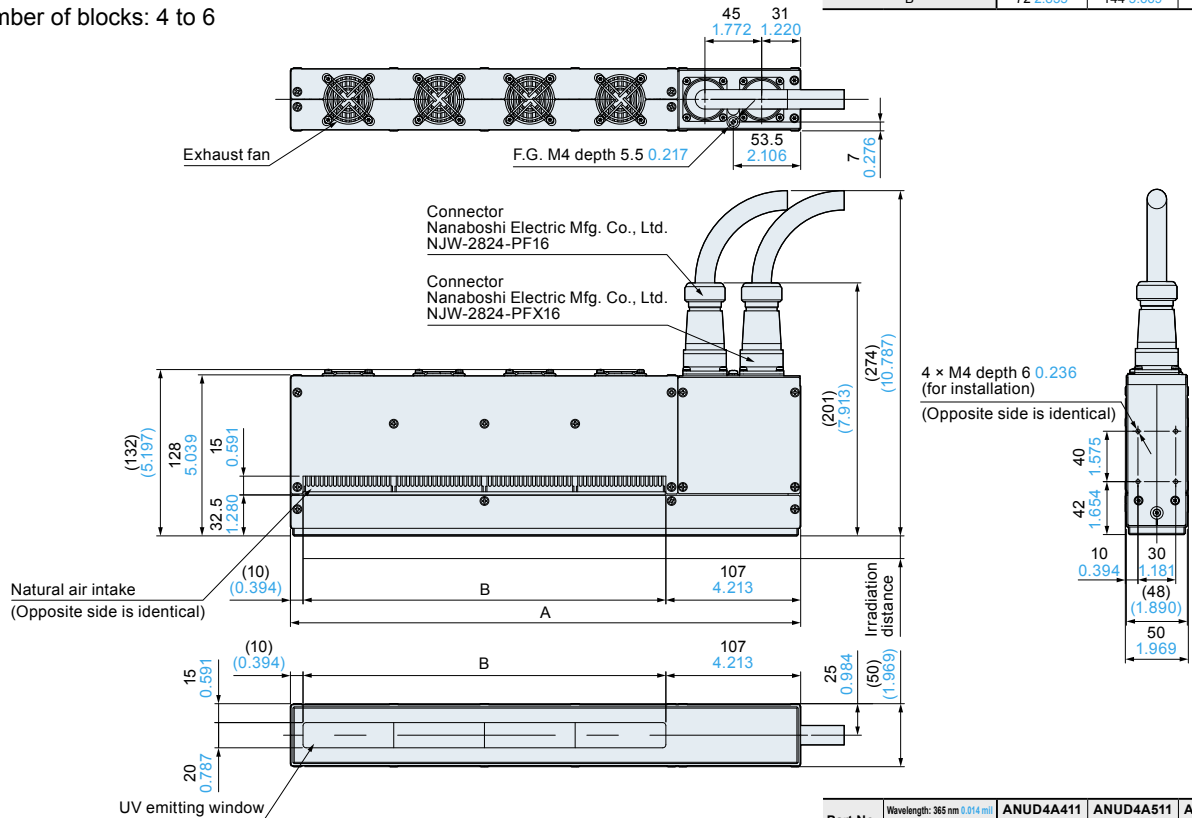

Part No.	Wavelength: 365 nm 0.014 mil	ANUD4A411	ANUD4A511	ANUD4A611
	Wavelength: 385 nm 0.015 mil	ANUD4B411	ANUD4B511	ANUD4B611
Number of blocks		4	5	6
Effective irradiation width	Irradiation distance: 10 mm 0.394 in	252 9.921	324 12.756	396 15.591
	Irradiation distance: 30 mm 1.181 in	232 9.134	304 11.968	376 14.803
External dimensions	Width	50 1.969		
	Height	(142 5.591)		
		(with receptacle, without connector and cable)		
	A (Length)	405 15.945	477 18.779	549 21.614
B	288 11.339	360 14.173	432 17.008	

**DIMENSIONS (Unit: mm in)**

**ANUD4S□ Controller**

**Control unit**

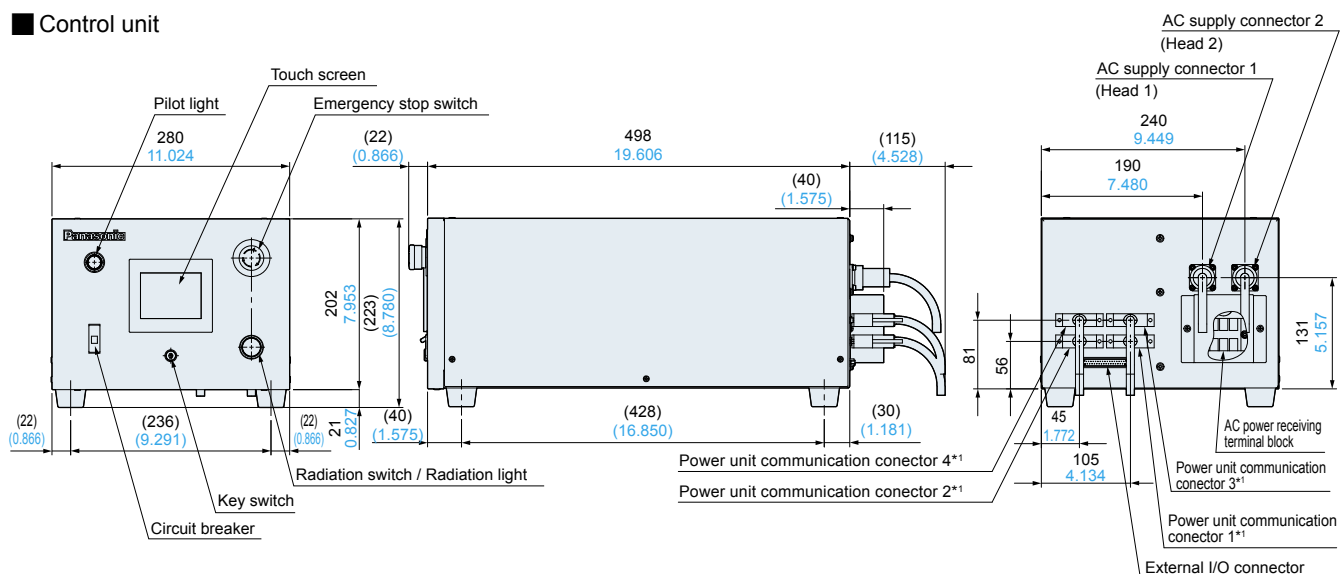

\*1: The position and number of power unit communication connectors depend on the number of connected power units. See the chart on the right for the corresponding models. (Figure above shows an example of using 4 power units)

**Power unit communication connector availability chart**

	Controller part No.						
	ANUD4S10	ANUD4S40	ANUD4S11	ANUD4S14	ANUD4S41	ANUD4S44	
Power unit communication connector	ANUD4S20	ANUD4S50	ANUD4S12	ANUD4S15	ANUD4S42	ANUD4S45	
	ANUD4S30	ANUD4S60	ANUD4S13	ANUD4S16	ANUD4S43	ANUD4S46	
			ANUD4S21	ANUD4S24	ANUD4S51	ANUD4S54	
			ANUD4S22	ANUD4S25	ANUD4S52	ANUD4S55	
			ANUD4S23	ANUD4S26	ANUD4S53	ANUD4S56	
			ANUD4S31	ANUD4S34	ANUD4S61	ANUD4S64	
			ANUD4S32	ANUD4S35	ANUD4S62	ANUD4S65	
			ANUD4S33	ANUD4S36	ANUD4S63	ANUD4S66	
	No. of power units	1	2	2	3	3	4
	Power unit communication connector 1	Available	Available	Available	Available	Available	Available
Power unit communication connector 2	None	Available	None	None	Available	Available	
Power unit communication connector 3	None	None	Available	Available	Available	Available	
Power unit communication connector 4	None	None	None	Available	None	Available	

**Power unit**

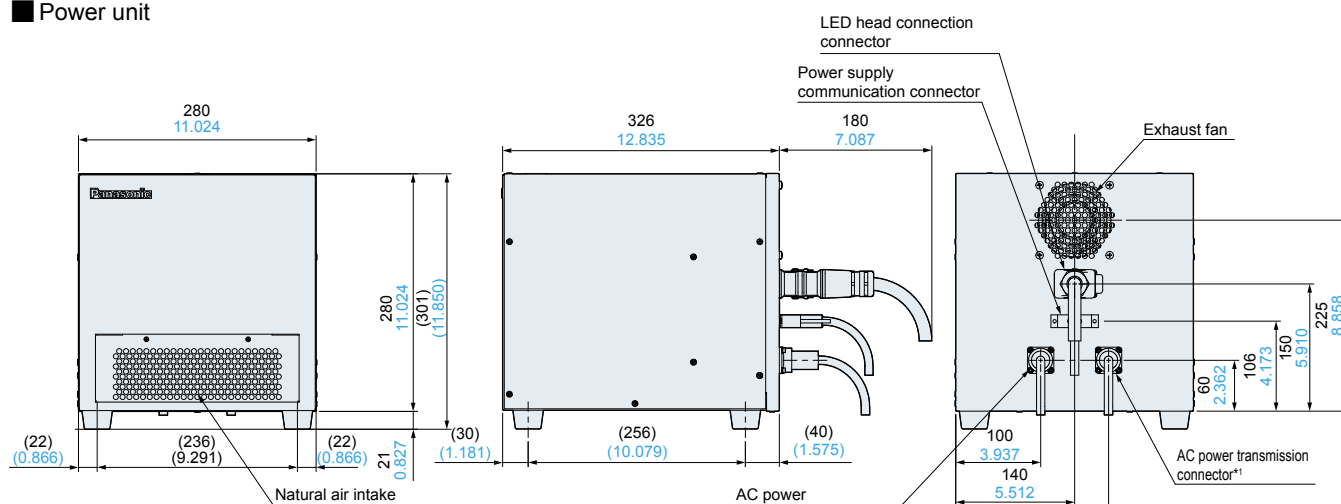



\*1: Whether an AC transmission connector is used depends on the controller model. See the chart on the right for information on which models use AC transmission connectors. (Figure above shows an example of using an AC transmission connector)

**AC power transmission connector availability chart** — : Power unit not available

	Controller part No.						
	ANUD4S10	ANUD4S40	ANUD4S11	ANUD4S14	ANUD4S41	ANUD4S44	
AC transmission connector used / not used	ANUD4S20	ANUD4S50	ANUD4S12	ANUD4S15	ANUD4S42	ANUD4S45	
	ANUD4S30	ANUD4S60	ANUD4S13	ANUD4S16	ANUD4S43	ANUD4S46	
			ANUD4S21	ANUD4S24	ANUD4S51	ANUD4S54	
			ANUD4S22	ANUD4S25	ANUD4S52	ANUD4S55	
			ANUD4S23	ANUD4S26	ANUD4S53	ANUD4S56	
			ANUD4S31	ANUD4S34	ANUD4S61	ANUD4S64	
			ANUD4S32	ANUD4S35	ANUD4S62	ANUD4S65	
			ANUD4S33	ANUD4S36	ANUD4S63	ANUD4S66	
	No. of power units	1	2	2	3	3	4
	Power unit-1	None	Available	None	None	Available	Available
Power unit-2	—	None	—	—	None	None	
Power unit-3	—	—	None	Available	None	Available	
Power unit-4	—	—	—	None	—	None	

# Line Up UV Curing Systems supporting various applications are available.

LED Type	
Spot Type	Line Type / Area Type
 <p><b>UJ30 / UJ35 series</b></p>	 <p><b>UD90 series</b></p>

**Disclaimer**

The applications described in the catalog are all intended for examples only. The purchase of our products described in the catalog shall not be regarded as granting of a license to use our products in the described applications. We do NOT warrant that we have obtained some intellectual properties, such as patent rights, with respect to such applications, or that the described applications may not infringe any intellectual property rights, such as patent rights, of a third party.

Please contact:

## Panasonic Industrial Devices SUNX Co., Ltd.

2431-1 Ushiyama-cho, Kasugai-shi, Aichi, 486-0901, Japan  
 Global Sales Department  
 ■Telephone: +81-568-33-7861 ■Facsimile: +81-568-33-8591  
[panasonic.net/id/pidsx/global](http://panasonic.net/id/pidsx/global)

