



Chipsmall Limited consists of a professional team with an average of over 10 year of expertise in the distribution of electronic components. Based in Hongkong, we have already established firm and mutual-benefit business relationships with customers from,Europe,America and south Asia,supplying obsolete and hard-to-find components to meet their specific needs.

With the principle of “Quality Parts,Customers Priority,Honest Operation,and Considerate Service”,our business mainly focus on the distribution of electronic components. Line cards we deal with include Microchip,ALPS,ROHM,Xilinx,Pulse,ON,Everlight and Freescale. Main products comprise IC,Modules,Potentiometer,IC Socket,Relay,Connector.Our parts cover such applications as commercial,industrial, and automotives areas.

We are looking forward to setting up business relationship with you and hope to provide you with the best service and solution. Let us make a better world for our industry!



Contact us

Tel: +86-755-8981 8866 Fax: +86-755-8427 6832

Email & Skype: info@chipsmall.com Web: www.chipsmall.com

Address: A1208, Overseas Decoration Building, #122 Zhenhua RD., Futian, Shenzhen, China



Energy saving, High brightness,
High accuracy UV irradiation using LED type
Complete range of Lamp type, too.

For resin curing in adhesion, printing, separation, coating, as a UV light source for inspection,
and for other uses, for workpieces and applications, choose from our lineup.

UJ30 / UJ35

LED
UV Curing System



UD40 series

LED
UV Curing System



UP50

LAMP
UV Curing System



ANUP8000 series

LAMP
UV Curing System

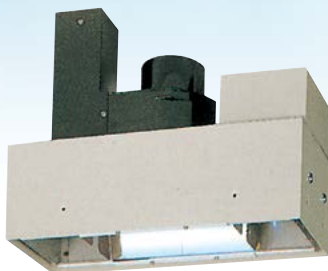

UD90 series

LED
UV Curing System









ANUP7000 series

LAMP
UV Curing System



The energy-efficient and high-precision UV irradiation systems come in the LED and lamp types to meet diverse requirements for a variety of workpieces.

Lineup

		Series	UV intensity	Advantages	Disadvantages
LED Type	Spot Type	 UJ35	UJ30 / UJ35 with 22,000 mW/cm ²	<ul style="list-style-type: none"> Low thermal stress Capable of irradiation ON / OFF control Low power consumption Stable UV irradiation 	<ul style="list-style-type: none"> Requires UV resin that cures at a single wavelength 365 nm, 385 nm or 405 nm (405 nm type is available for combining with UJ30 / UJ35 only)
	Line Type		UD40 series with 4,600 mW/cm ²	<ul style="list-style-type: none"> Long estimated light source life Small size Does not generate ozone Exhaust duct not required 	
	Line Type		UD90 series with 10,000 mW/cm ²	<ul style="list-style-type: none"> Can be used with large equipment Suitable for UV irradiation through polycarbonate (UJ30 / UJ35 405 nm type) 	
Lamp Type	Spot Type		UP50 with 6,000 mW/cm ²		
	Tube Type		ANUP8000 series 1.5 kW (Note) 3 kW (Note) 6 kW (Note)	<ul style="list-style-type: none"> Broad UV wavelength range (including heat rays) 	<ul style="list-style-type: none"> High thermal stress Short lamp life
			ANUP7000 series 3 kW (Note) 6 kW (Note)	<ul style="list-style-type: none"> Compatible with a variety of UV resins 	<ul style="list-style-type: none"> Exhaust duct required (tube type)
			ANUP3000 series 1.5 kW (Note) 3 kW (Note)		

Note: For the tube type, the lamp output is indicated.

Applications

Bonding and curing applications



Assembly of lens modules



Fixing and bonding of camera modules

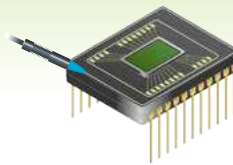

Adhesion of image sensor glass

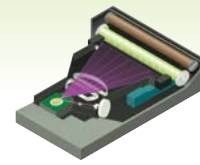

Optical parts for printers and copiers

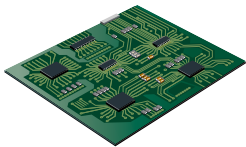

Resin coatings for printed circuit boards



Adhesion of vehicle coil terminals

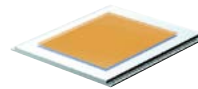

Sealing of LCDs and organic ELs

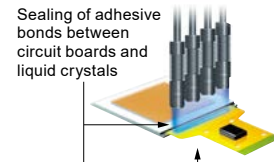

Sealing of adhesive bonds between circuit boards and liquid crystals

Reinforcement of UV resin at flexible board junctions

Adhesion of vibrating plates (cones)

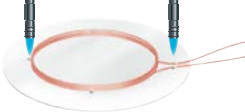

Adhesion of voice coils

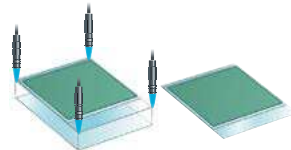

Temporary adhesion and permanent curing of touch panels

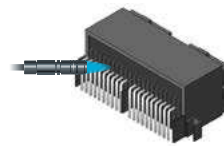

Reinforcement and waterproofing of vehicle-use connectors



Adhesion of touch panels and printed circuit boards

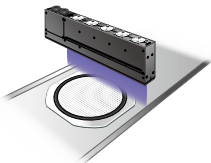

Curing and separation of dicing film and BG film



Adhesion of injection needles and medical devices

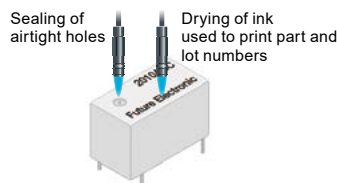

Curing of ink used to print text on electronic components

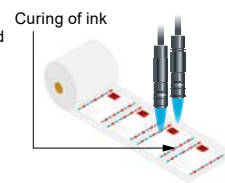

Curing of ink used to print labels

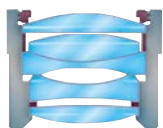

Manufacture of hybrid lenses



Hard coating for cases and all kinds of ornaments

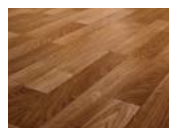

Construction material and flooring coatings



UV printing UV ink jet printing

UV light sources for testing use



Luminescence testing of fluorescent substances



Testing for the presence of oil, grease, and other materials containing fluorescent substances

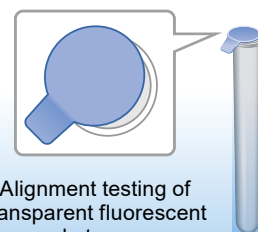

Alignment testing of transparent fluorescent substances

Featuring Panasonic high-efficiency lens *1 High-output Head equivalent to 20,000 mW/cm² class *2

*1 Lens embedded in the head of ANUJ6186, ANUJ6188 or ANUJ6189.

*2 Peak value and representative value at an irradiation distance of 8 mm (0.315 in) when ANUJ6186 or ANUJ6423 is used.

High-output head equipped with new high-efficiency lens

Wavelength 365 nm **ANUJ6186** Wavelength 405 nm **ANUJ6189**

Wavelength 385 nm **ANUJ6188**



Standard type head inherits an existing intensity profile

Wavelength 365 nm **ANUJ6180** Wavelength 405 nm **ANUJ6187**

Wavelength 385 nm **ANUJ6184**

UV intensity comparison with existing models

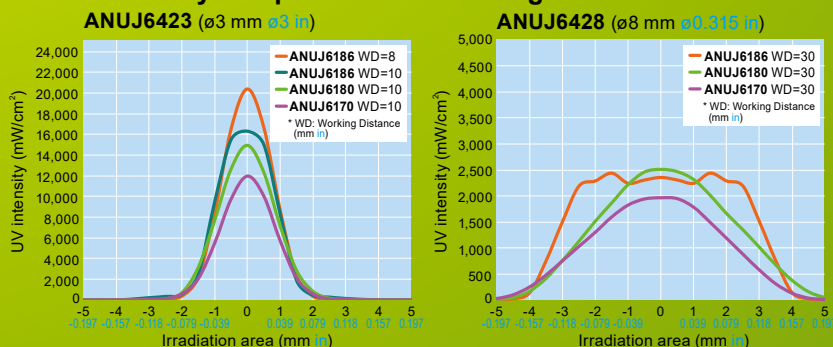

The intensity profiles shown are representative values, not guaranteed values. Install the metal attachment (ANUJ6804), or take other heat radiation measures.

Advantage 1 Tact time can be significantly reduced.





Advantage 2 If the same UV intensity as the existing head model is required, output can be reduced, which will save power and extend LED life.

Advantage 3 The UV irradiation area can be significantly expanded.

Advantage 4 405 nm type Extend UV curing to coatings that were hard to irradiate. Now, you can even perform photo-curing of adhesion through glass or resin.

High-performance of High-output head brings real benefit! User-friendliness and Stable Irradiation

Controller selections for you applications UJ30 / UJ35

Controller selection for you applications	Standard model UJ30 Limited to most necessary and sufficient functions provides highly reliable UV irradiation. 	High performance model UJ35 A variety of functions will provide more advanced UV irradiation solution. 
User-friendly	Easy-to-read display and easy-to-operate panel are as simple to use as a home appliance.	
Stable irradiation	The LED head incorporates a temperature sensor. The temperature feedback control provides excellent irradiation stability. 	
Four-head irradiation	Different irradiation power and time can be set for each LED head attached to the controller. Both "all" and "individual" UV irradiation modes are available.	
External control	UV irradiation operation can be externally controlled using the parallel I/O, enabling automatic control suitable for production lines.	UV irradiation operation can be externally controlled using the parallel I/O or the RS232C port, enabling automatic control suitable for production lines.
UV sensor	—	UV intensity measurement and automatic calibration can be done at the actual production line using the slim UV sensor. 
Programmable irradiation	—	The programmable irradiation function helps prevents curing distortion and enable high-quality precision bonding at a lower temperature.
Multiple setting profiles	—	Up to 8 different irradiation patterns can be saved.
UJ35 software (Note)	—	Free downloadable software available from our website for easy PC operation. Software will allow you to operate the unit from a PC. Also allows you to save irradiation programs. Japanese, English, Chinese and Korean languages available.
Global 3-year warranty	Guaranteed for three years from date of purchase (controller only) For details, please visit our website. http://industrial.panasonic.com/ac/efasys/warranty/index.jsp 	

Note: Downloadable from the following URL: http://industrial.panasonic.com/ac/efasys/software_info/uv/tol_uj30-uj35.jsp

Quick setup immediately after installation

User Friendly Interface



Simple interface

Easy-to-read display and easy-to-operate panel

UJ30 / UJ35 can be easily set up like setting up a home appliance. Only three switches required for basic settings.

- 1 Choose LED head (CH1 to CH4).
- 2 Set UV irradiation intensity (%).
- 3 Set irradiation time.

(0.0 sec. to 999 sec., continuous irradiation: [Con])
To set [Con], press "▼" once again at 0.0 sec. or press "▲" once again at 999 sec.

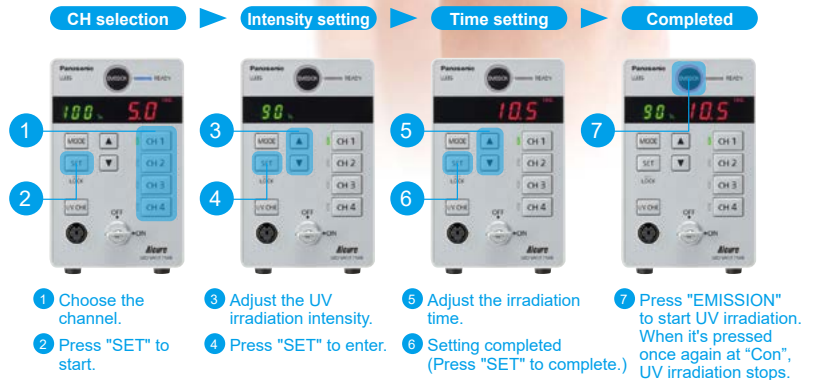

Four individually controllable LED heads

The irradiation power and time can be individually controlled.

The irradiation power, time, and timing of the LED heads can be individually controlled. With the lamp type model, one process requires one irradiation unit. With UJ30 / UJ35, one unit can be used for up to four processes due to its four individually-controllable LED heads. It will also show a notice if any of the LED head reaches time to replace or when there is a temperature warning on one of the heads.



External control

UV irradiation can be controlled by external signal inputs, enabling automatic control in production lines.

UV irradiation (time and irradiation timing) of the LED heads can be controlled by parallel signals from a programmable controller or other external devices.

A variety of control is possible. For example, UV irradiation time can be set up in increments of 0.1 seconds by the controller for each LED head. And an external signals can be used to individually start or stop the UV irradiation of the LED heads. With UJ35, irradiation control using RS232C (Note 1) is available.

"UJ35 software (free) (Note 2)," the setup process can be easily set up using a PC.

Notes: 1) Use straight RS232C for connection to PC or similar. Cable side: D-sub connector 9-pin (female pin)
2) Downloadable from our website.
http://industrial.panasonic.com/ac/e/fasys/software_info/uv/tol_uj30-uj35.jsp

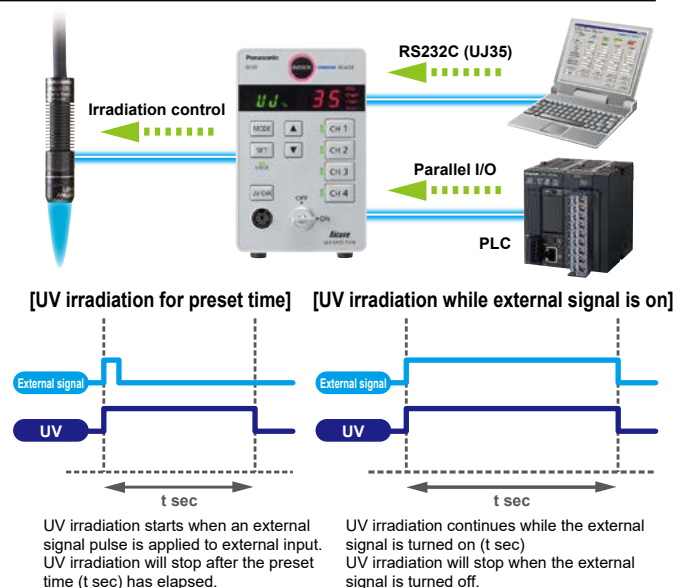

Strict quality control

Stable Irradiation

Prevention of resin curing defects and bonding failures

Temperature feedback control

Panasonic's original

±3 % or better UV irradiation accuracy (for wavelength 365 nm / 385 nm type with the intensity set to 80 %)

Generally, when the LED temperature rises, the UV irradiation output decreases. To prevent the temperature to rise, the LED heads are built with metal materials with fins to increase heat dissipation. The LED heads are also equipped with a built-in temperature sensor to feedback the temperature to the controller. The controller will calculate the loss of power due to temperature increase, enabling stable UV irradiation at an accuracy within ±3 % when the intensity is set to 80 %. This high performance is ideal for high-quality and precision bonding applications.

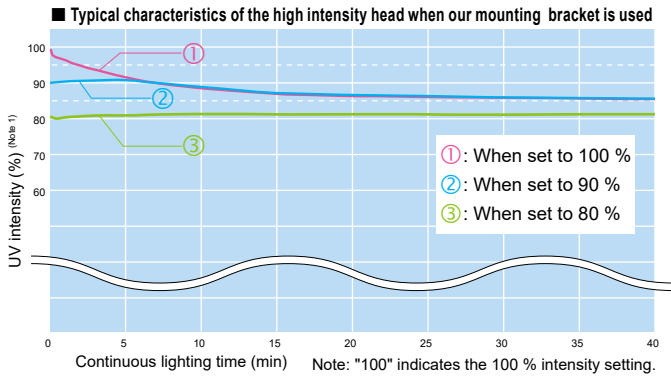

Infrared rays-free UV irradiation

High-accuracy bonding without thermal distortion

The LED heads irradiate 365 nm, 385 nm wavelength UV rays or 405 nm short wavelength, which do not contain infrared rays (heat) unlike the light from the lamp type system, preventing the temperature rise of workpieces. This is ideal for applications that require high precision bonding with minimum thermal distortion, such as the assembly of thin plastic lenses.

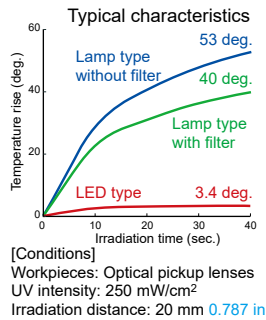

LED emission spectrum

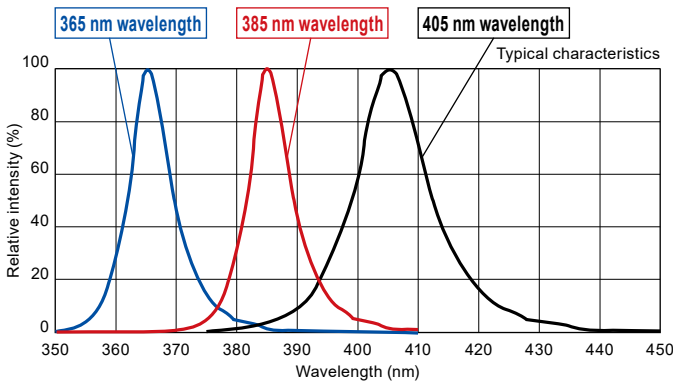

Programmable irradiation function (for UJ35)

This function prevents curing distortion and enables high-quality precision bonding.

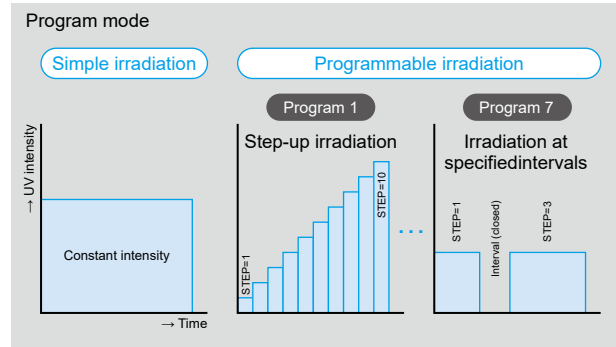

The irradiation can be programmed to controls the irradiation power and time depending on the resin and curing application, supporting high-quality and high-precision bonding with minimum cure shrinkage. In addition to the simple irradiation mode which irradiation is continuously performed at a constant intensity, up to 10 steps 7 different irradiation patterns (7 product types) can be programmed for each of the four LED head.

Significantly higher reliability for bonding and fixing

Slim UV sensor (for UJ35)

Panasonic's original

The UV sensor for measuring irradiation intensity enables auto-turning in high-accuracy.

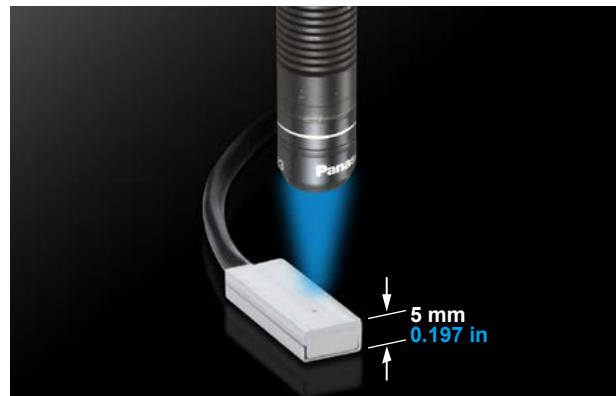

The UV irradiation intensity of the LED heads can be relative measured at the actual position by using the optional slim UV sensor (Note). It can also automatically adjust the UV intensity to the preset level. Since the sensor only has 5 mm 0.197 in thickness, which is similar to the workpiece, the intensity measurement is possible without removing the system from the production line, facilitating high-accuracy setting and in-line condition optimization. The UV intensity can be checked and adjusted at real time, enhancing the bonding and fixing reliability.

Note: UV intensity can be measured as a relative value.
Sensitivity adjustment of the UV sensor is carried out at 365 nm, if you use the UV sensor at 385 nm or 405 nm, the displayed value may be greater than the actual UV intensity.
For more information, please consult us.

Safe and reliable

Environmental Consciousness and Reliable

Frequent part replacement is reduced by LED type.
Long-lasting cost effective LED type

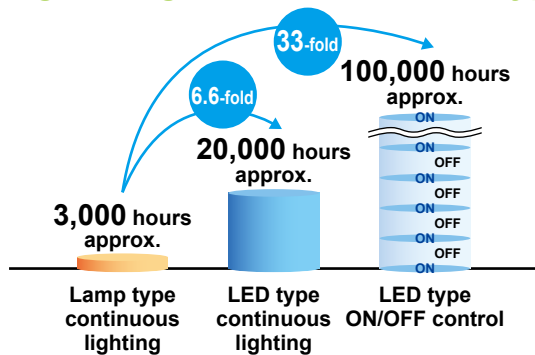

One of the biggest benefits of using the LED type is that the light source life is much longer than lamps used in lamp type. The life of the lamp is 3,000 hours approx., but the LED has 20,000 hours approx. Further more, unlike the lamp type, which needs to be kept turned on through out the operation, the LED type can turn on UV irradiation only when it is needed. When the irradiation ON/OFF time ratio is 1:4 (process cycle time = 5, irradiation time = 1), the LED type operation life is equivalent to 100,000 hours approx. compared to lamp types, leading to significant reductions in running costs and hours for maintenance.

You can see LED head temperature readings on the display! **Panasonic's original**

Designed to dissipate heat, estimation of life is easy.



While the display is showing irradiation conditions, you can see the temperature of the LED head simply by pressing the MODE button. The controller is designed to dissipate heat, and it is easy to estimation of life.

■ Estimated life according to LED temperature (The value is not a guaranteed value.)

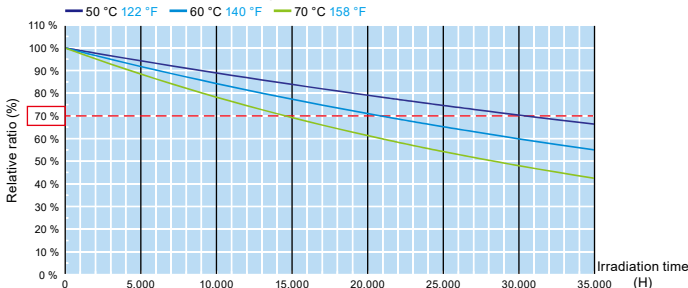

Reliable operation anywhere in the world **Panasonic's original**

Covered by the global 3-year warranty



Guaranteed for three years from the date of purchase (controller only), providing reliability even if the manufacturing line is at remote location. For details, please visit our website

<http://industrial.panasonic.com/ac/e/fasys/warranty/index.jsp>

Flexible cable for LED head will enable installation to even moving sections.

Standard Flexible head cables



Flexible cable has been adopted as the standard LED head connection cable considering that the LED heads will be mounted on to a moving section. Unlike silica fiber cables where there is a risk of damaging the cable by moving the cable too much, these flexible cables can be easily handled without risk of damaging. (withstanding 10 million bends to a radius of 33 mm 1.299 in based on our evaluation). The cables can be extended to a maximum of 10 m 32.808 ft using extension cables, which also have the same flexibility.

(The minimum allowable bend radius for 5 m 16.404 ft or longer cable diameter 5.5 mm 0.217 in is R45.6 mm 1.795 in.)

Ideal for high-precision process. Helps reducing costs.

Cooling fan-less structure

Without the need for a cooling fan, it is ideal for vibration-sensitive or dust-sensitive high precision process. Also, this design reduces need for exhaust ventilation ducting and related installation work as well as the running costs for exhaust ventilation and air conditioning.

Lead and Mercury free

Eco product compliant with CE, RoHS, etc.



Unlike lamps LED heads do not contain mercury. UJ30 and UJ35 conform to CE Marking, RoHS Directive, and Management Methods for Controlling Pollution by Electronic Information Products (China RoHS), ensuring environmentally safe use. (Please follow the proper industrial waste disposal procedures.)

Available for worldwide use

We have local sales companies to support the expansion of customers' global operations. Please visit our website to see our worldwide sales network.

<http://industrial.panasonic.com/ac/e/salesnetwork/index.jsp>



Intensity Profiles (Typical example)

Featuring Panasonic high-efficiency lens (Note)

High-output head UV wavelength 365 nm (ANUJ6186)

Please see the Web site for intensity profiles data of UV wavelengths 385 nm (ANUJ6184, ANUJ6188) and 405 nm (ANUJ6187, ANUJ6189).

<http://industrial.panasonic.com/ac/e/fasys/uv/led/uj30-uj35/data/index.jsp>

Note: Lens embedded in the head of ANUJ6186, ANUJ6188 or ANUJ6189.

Standard lens and Protective glass

* WD: Working Distance (mm)

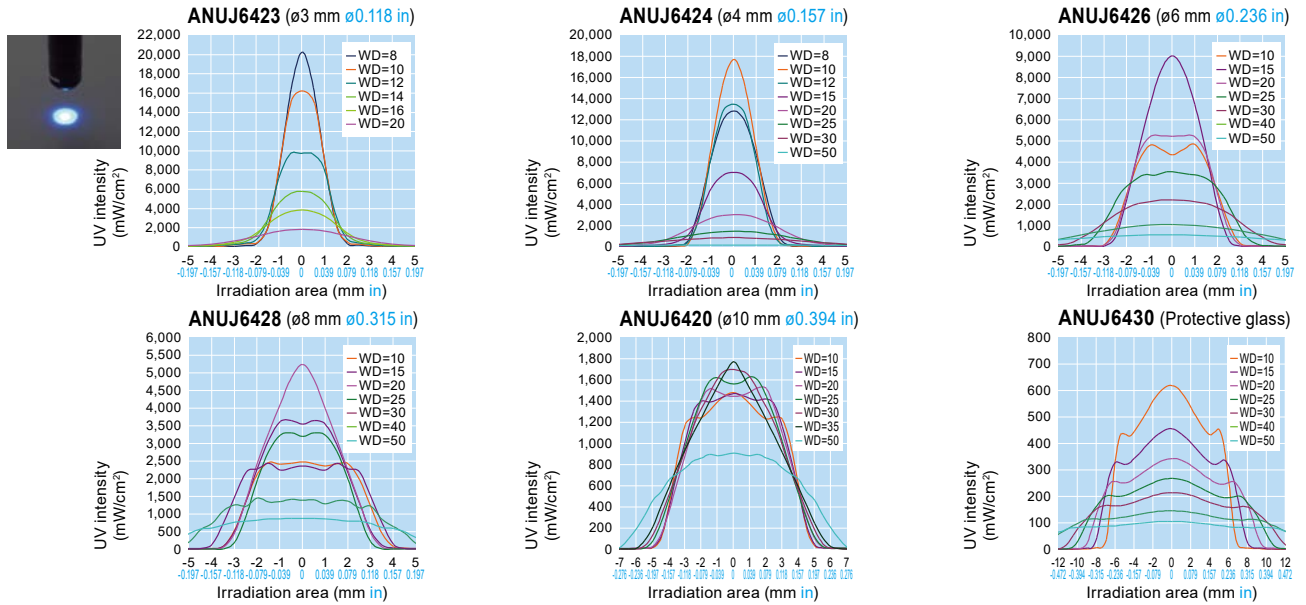

Side view lens

* WD: Working Distance (mm)

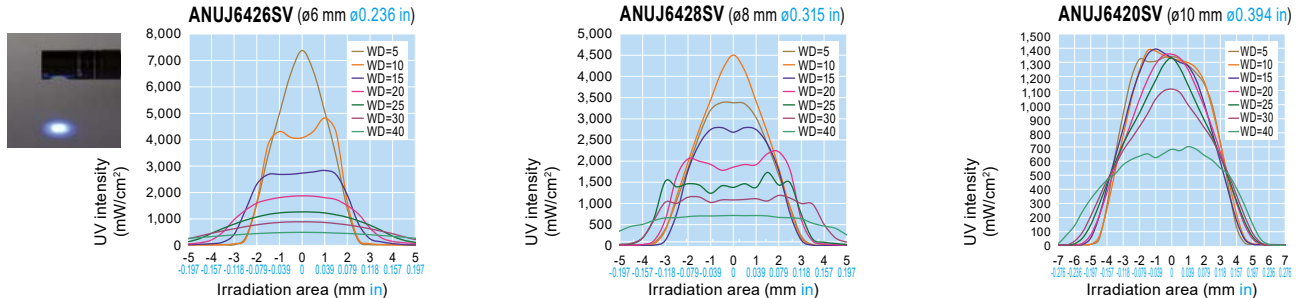

Cylindrical lens

* WD: Working Distance (mm)

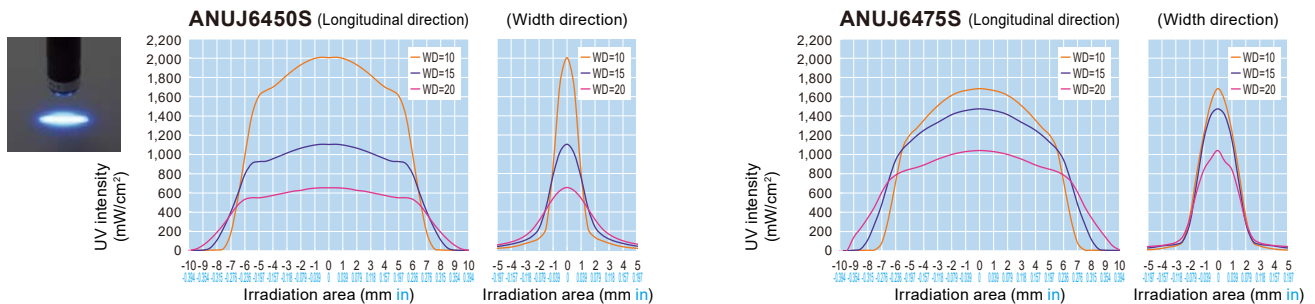

Rod lens

* WD: Working Distance (mm)

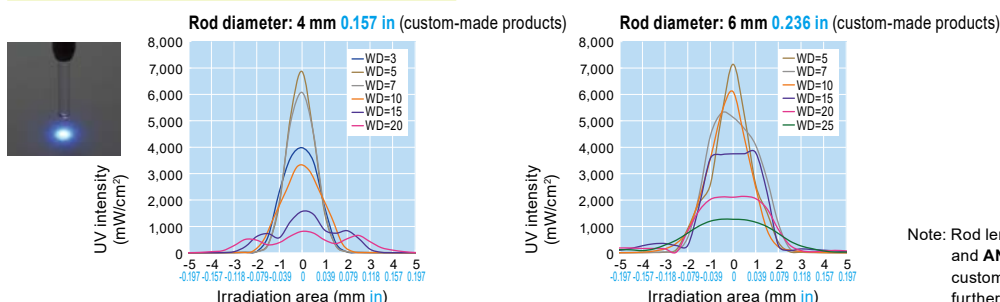

Note: Rod lens combined with ANUJ6186, ANUJ6188 and ANUJ6189 high-output heads are treated as custom-made products. Please consult us for further information.

Inherits an existing intensity profile

Standard type head UV wavelength 365 nm (ANUJ6180)

Please see the Web site for intensity profiles data of UV wavelengths 385 nm (ANUJ6184, ANUJ6188) and 405 nm (ANUJ6187, ANUJ6189).
<http://industrial.panasonic.com/ac/e/fasys/uv/led/uj30-uj35/data/index.jsp>

Standard lens and Protective glass

* WD: Working Distance (mm)

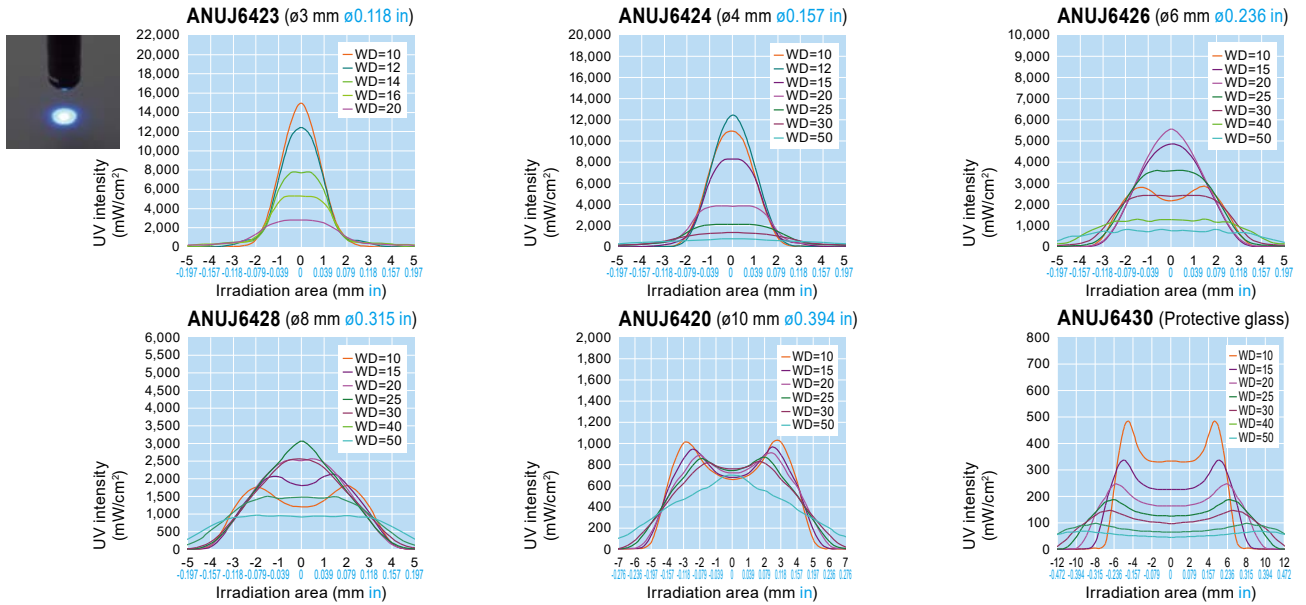

Side view lens

* WD: Working Distance (mm)

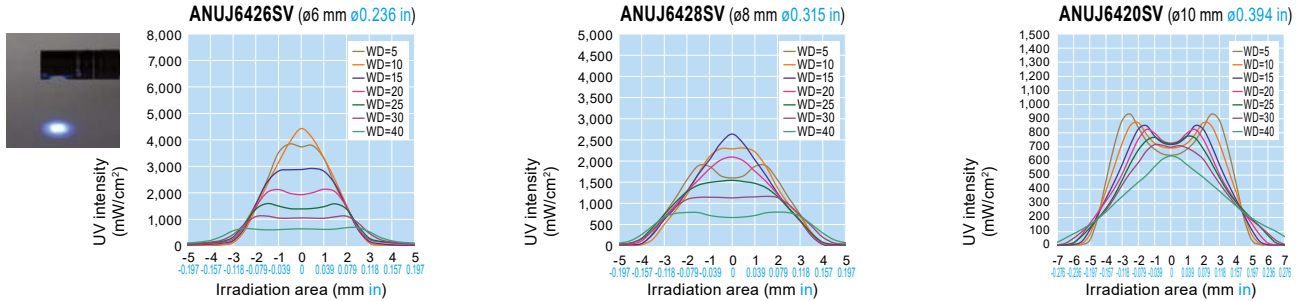

Cylindrical lens

* WD: Working Distance (mm)

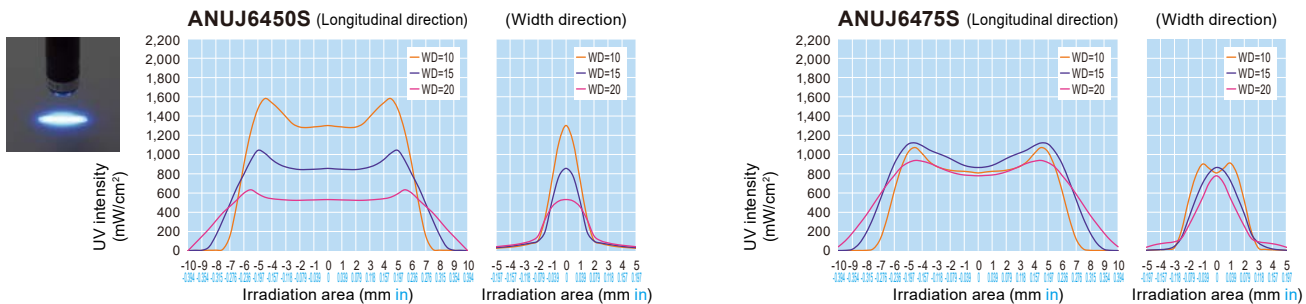

Rod lens

* WD: Working Distance (mm)

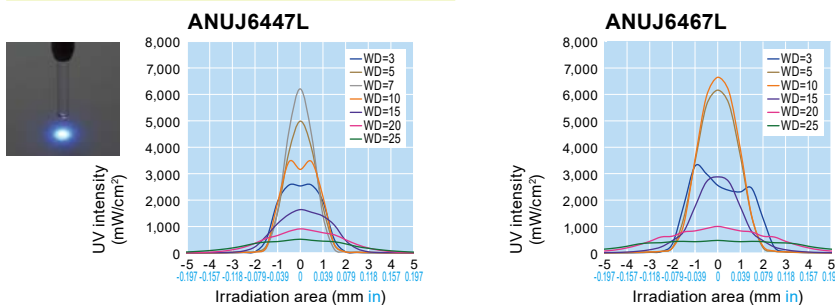

Wide variation Product Lineup

Controllers

UJ30 controller
ANUJ3000



- Up to four heads can be connected.
- With an AC adapter (ANUJ6802)

UJ35 controller
ANUJ3500



- Up to four heads can be connected.
- With an AC adapter (ANUJ6802)
- Compatible with a UV sensor (ANUJ3800)

UV sensor
ANUJ3800



UV sensor for UJ35 / UP50 (includes 2 m 6.562 ft ANUJ38102 cable)

UV sensor extension cable
ANUJ38110 (10 m 32.808 ft)
ANUJ38102 (2 m 6.562 ft)



UV sensor connection cable (ANUJ38102 is the same cable that ships with the UV sensor)

Connection cable

ANUJ62**



Cable length 1.7 m 5.906 ft (Cable diameter: ø 5.5 mm ø 0.217 in): ANUJ6220
Cable length 3 m 9.843 ft (Cable diameter: ø 5.5 mm ø 0.217 in): ANUJ6230
Cable length 5 m 16.404 ft (Cable diameter: ø 7.6 mm ø 0.299 in): ANUJ6250
Cable length 7 m 22.966 ft (Cable diameter: ø 7.6 mm ø 0.299 in): ANUJ6270
Cable length 10 m 32.808 ft (Cable diameter: ø 7.6 mm ø 0.299 in): ANUJ6200

(Note 1)
Heads & Cables

High-output head 365 nm
ANUJ6186



- ø12 × 50 mm ø0.472 × 1.969 in
- Cable length 0.2 m 0.656 ft

Standard type 365 nm
ANUJ6180



- ø12 × 50 mm ø0.472 × 1.969 in
- Cable length 0.2 m 0.656 ft

High-output head 385 nm
ANUJ6188



- ø12 × 50 mm ø0.472 × 1.969 in
- Cable length 0.2 m 0.656 ft

Standard type 385 nm
ANUJ6184



- ø12 × 50 mm ø0.472 × 1.969 in
- Cable length 0.2 m 0.656 ft

High-output head 405 nm
ANUJ6189



- ø12 × 50 mm ø0.472 × 1.969 in
- Cable length 0.2 m 0.656 ft

Standard type 405 nm
ANUJ6187



- ø12 × 50 mm ø0.472 × 1.969 in
- Cable length 0.2 m 0.656 ft

Lenses

Standard lens
ANUJ642*



- Circular irradiation
- ø 3 mm 0.118 in: ANUJ6423
- ø 4 mm 0.157 in: ANUJ6424
- ø 6 mm 0.236 in: ANUJ6426
- ø 8 mm 0.315 in: ANUJ6428
- ø 10 mm 0.394 in: ANUJ6420

Side view lens
ANUJ642*SV



- Circular irradiation Angled at 9°
- ø 6 mm 0.236 in: ANUJ6426SV
- ø 8 mm 0.315 in: ANUJ6428SV
- ø 10 mm 0.394 in: ANUJ6420SV

Cylindrical lens
ANUJ64S**



- Elliptical irradiation
- R5 : ANUJ6450S
- R7.5: ANUJ6475S

Rod lens
ANUJ64*7L (For standard head)



- Small diameter circular irradiation
- ø4 mm 0.157 in: ANUJ6447L
- ø6 mm 0.236 in: ANUJ6467L

*Rod lens combined with ANUJ6186, ANUJ6188 and ANUJ6189 are treated as custom-made products. Please consult us.

Options

AC adapter (Note 2)
ANUJ6802

100 to 240 V AC adapter supplied with the controller unit
With a 100 V AC power cable

200 V AC power cable
ANUJ6803

200 V AC power cable for ANUJ6802 (Note 3)

Mounting bracket
ANUJ6804

Head mounting bracket
Material: Aluminum

Protective glass
ANUJ6430

For head protection if lenses are not used.

Notes: 1) The head does not come with a lens.
2) The ANUJ6802 AC adapter is supplied with the controller unit. The ANUJ6802 AC adapter is compatible with 100 to 240 V AC; however, the primary-side power cable is compatible with 100 V AC only. For use in a 200 V AC region, purchase the ANUJ6803 primary-side power cable (for 200 V AC) separately.
3) For China only. Primary-side A-type plug. (Since this product is not PSE Mark compliant, it cannot be connected directly to a lamp line in Japan.)

Specifications

Controllers		
Controller Product type	UJ30 (Standard model)	UJ35 (High performance model)
Controller Part No.	ANUJ3000	ANUJ3500
Connectable heads	1 to 4 heads	
Connectable UV sensor	Not compatible	Compatible
UV irradiation	One pattern irradiation in simple mode The heads are either collectively or individually controlled.	One pattern in simple mode and programmed pattern irradiation (up to 7 patterns with up to 10 steps) The heads are either collectively or individually controlled.
Pattern switching	None (1 type)	Switchable (8 types)
Intensity / irradiation control	Digital intensity and irradiation control manual or timer control (0.1 to 99.9, 100 to 999 sec.) Auto-tuning function using the UV sensor (for UJ35 only) Specifications of UV sensor: [Temperature characteristic: ±5 % F.S. (+5 to +35 °C 41 to 95 °F) / Repeat accuracy: ±1 % (25 °C 77 °F)]	
Setting/Operation	Setting by the operation switches and power-on/off by a key switch	Setting by the operation switches, power-on/off by a key switch and RS232C (UJ35 setup tool)
Display	7-segment display	
Cooling system	Natural cooling (without a fan)	
External control	Method	Parallel I/O (without a fan) / RS232C, Parallel I/O
	External input	Individual irradiation input, irradiation stop input, interlock, full-irradiation input, pattern switching (for UJ35 only)
External output	READY signal, error signal, alarm output, BUSY output (each head separately), +5 V output (for indicator)	
Operating voltage	With AC adapter: 100 - 240 V AC (±10 %) 50 / 60 Hz 60 VA (at 100 V AC)	
Ambient temperature / humidity range	0 to +35 °C 32 to 95 °F / 30 to 85 % RH (no condensation)	
Storage temperature / humidity range	-10 to +60 °C 14 to 140 °F / 30 to 85 % RH (no condensation)	
Accessories	AC adapter and Key	
Weight	1,180 g approx. (Controller: 940 g approx., AC adapter: 240 g approx.)	1,200 g approx. (Controller: 960 g approx., AC adapter: 240 g approx.)

Heads												
Wavelength	Head model No.	ANUJ6186										
		Compatible lens	Spot diameter	ø3 mm ø0.118 in	ø4 mm ø0.157 in	ø6 mm ø0.236 in	ø8 mm ø0.315 in	ø10 mm ø0.394 in	Protective glass			
365 nm wavelength high-output head	Compatible lens	ANUJ6423	ANUJ6424	ANUJ6426	ANUJ6428	ANUJ6420	ANUJ6430					
	UV intensity (mW/cm ²) ¹⁾	17,200	14,940	7,560	4,450	1,360	530					
	Irradiation distance	8 mm 0.315 in	10 mm 0.394 in	15 mm 0.591 in	20 mm 0.787 in	30 mm 1.181 in	10 mm 0.394 in					
	Head model No.	ANUJ6180										
365 nm wavelength standard type	Compatible lens	ANUJ6423	ANUJ6424	ANUJ6426	ANUJ6428	ANUJ6420	ANUJ6430					
	UV intensity (mW/cm ²) ¹⁾	12,500	10,600	4,720	2,500	580	300					
	Irradiation distance	10 mm 0.394 in	12mm 0.472 in	20 mm 0.787 in	25 mm 0.984 in	30 mm 1.181 in	10 mm 0.394 in					
	Head model No.	ANUJ6188										
385 nm wavelength high-output head	Compatible lens	ANUJ6423	ANUJ6424	ANUJ6426	ANUJ6428	ANUJ6420	ANUJ6430					
	UV intensity (mW/cm ²) ¹⁾	19,500	16,920	8,680	4,750	1,400	580					
	Irradiation distance	8 mm 0.315 in	10 mm 0.394 in	15 mm 0.591 in	20 mm 0.787 in	30 mm 1.181 in	10 mm 0.394 in					
	Head model No.	ANUJ6184										
385 nm wavelength standard type	Compatible lens	ANUJ6423	ANUJ6424	ANUJ6426	ANUJ6428	ANUJ6420	ANUJ6430					
	UV intensity (mW/cm ²) ¹⁾	14,700	11,700	5,800	2,790	590	330					
	Irradiation distance	10 mm 0.394 in	12mm 0.472 in	15 mm 0.591 in	20 mm 0.787 in	30 mm 1.181 in	10 mm 0.394 in					
	Head model No.	ANUJ6189										
405 nm wavelength high-output head	Compatible lens	ANUJ6423	ANUJ6424	ANUJ6426	ANUJ6428	ANUJ6420	ANUJ6430					
	UV intensity (mW/cm ²) ¹⁾	20,900	17,800	9,190	5,450	1,790	810					
	Irradiation distance	8 mm 0.315 in	10 mm 0.394 in	15 mm 0.591 in	20 mm 0.787 in	30 mm 1.181 in	10 mm 0.394 in					
	Head model No.	ANUJ6187										
405 nm wavelength standard type	Compatible lens	ANUJ6423	ANUJ6424	ANUJ6426	ANUJ6428	ANUJ6420	ANUJ6430					
	UV intensity (mW/cm ²) ¹⁾	15,500	12,600	5,730	3,150	890	440					
	Irradiation distance	10 mm 0.394 in	12mm 0.472 in	20 mm 0.787 in	25 mm 0.984 in	30 mm 1.181 in	10 mm 0.394 in					
	Head model No.	ANUJ6187										
Common item	Light source	Class 3B LED product (JIS S6802:2005) Risk group 3 (ANUJ6189 / ANUJ6187 Risk group 2) (IEC 62471)										
	Estimated light source life ²⁾	20,000 hours (when the LED temperature inside the head is 60°C 140°F)										
	Cable length	0.2 m 0.656 ft. A connection cable is required to connect the high-output head to a UJ series controller.										
	Operating temperature and humidity	+5 to +35 °C +41 to +95 °F / 30 to 85 % RH (No condensation)										
	Storage temperature and humidity	-10 to +60 °C +14 to +140 °F / 30 to 85 % RH (No condensation)										

Notes: 1) The values were measured using a UJ30 / UJ35 illuminometer with ø1 mm ø0.039 in sensor hole when the high-output heads were fixed to the attachment, the ambient temperature was maintained at 25 °C (77 °F) by the UJ30 / UJ35, and they were turned on with 100% output (initial value: based on Panasonic's reference measurement).
2) It is recommended that protective glass (ANUJ6430) be used to protect the head-side lens from contamination when the high-output head is used without a lens. For further information about protective glass, contact our sales office.
3) The value is not a guaranteed value.

Dimensions (Unit: mm in) Excluding the protruding sections

UJ30 / UJ35

UJ35 Controller
ANUJ3500

(Weight: 960 g approx.)

UJ30 Controller
ANUJ3000

(Weight: 940 g approx.)

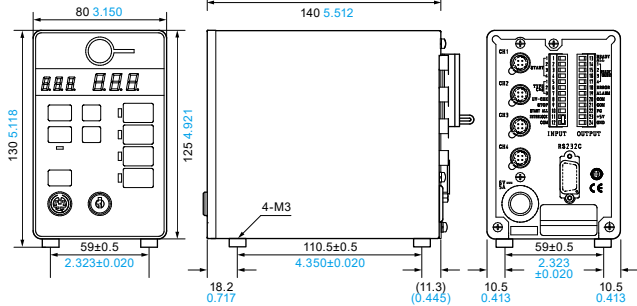

UV sensor ANUJ3800

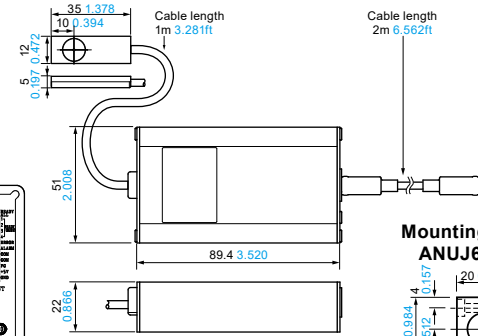

Cable length
1m 3.281ft

Cable length
2m 6.562ft

Mounting bracket for head
ANUJ6804

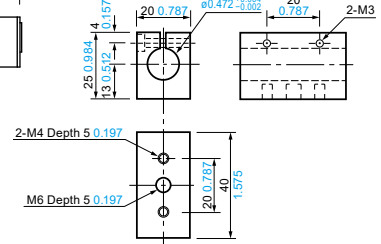

AC adapter ANUJ6802

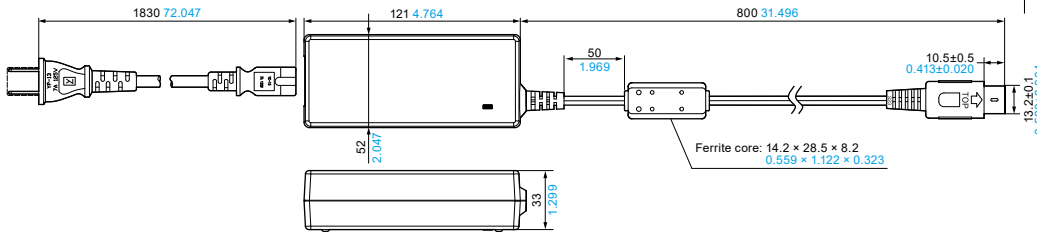

Head sections (with standard lens)

ANUJ6180 / ANUJ6184 / ANUJ6186 / ANUJ6187 / ANUJ6188 / ANUJ6189

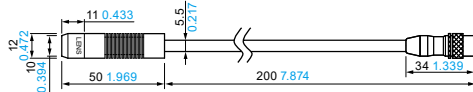

200V AC power cable ANUJ6803

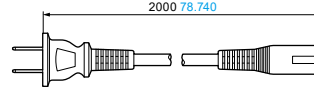

* Type A plug

Connection cable



Standard and Cylindrical lens

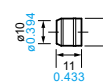

Rod lens

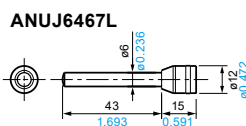

Side view lens

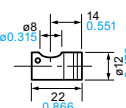

ANUJ6447L

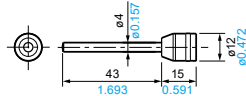

Protective glass

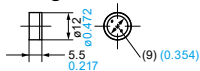

Input and Output specifications

Input specifications

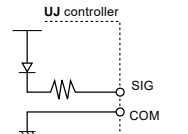

Contact input

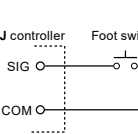

Non-contact input

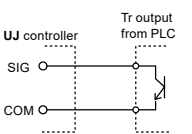

Open collector (Tr) or non-voltage input such as a relay

Output specifications

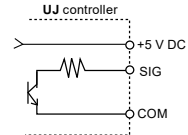

With external power supply

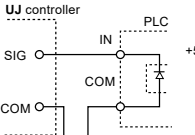

With internal power supply

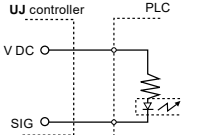

Rated operation voltage: 5 to 24 V DC
Output capacity: 100 mA (max.)

I/O list

INPUT		OUTPUT	
Terminal No.	Signal	Terminal No.	Signal
1	START1	13	READY-All
2	START2	14	READY/BUSY1 (Note 2)
3	START3	15	READY/BUSY2 (Note 2)
4	START4	16	READY/BUSY3 (Note 2)
5	TYPE Chg1 (Note 1)	17	READY/BUSY4 (Note 2)
6	TYPE Chg2 (Note 1)	18	ERROR
7	TYPE Chg3 (Note 1)	19	ALARM
8	UV CHECK (Note 1)	20	COM
9	STOP	21	COM
10	START-All	22	FG
11	INTERLOCK (Note 3)	23	+5 V DC
12	COM	24	COM

Notes: 1) Nos. 5 / 6 / 7 / 8 (Type-Chg 1 / 2 / 3 and UV-CHECK) are functions available UJ35 only.
These terminals for UJ30 are spare.
2) The READY/BUSY switching of Nos. 14 / 15 / 16 / 17 is performed on the UJ30 / UJ35 controller.
3) At shipment, for B-contact (allows irradiation when ON), No.11 (INTERLOCK) is connected to No.12 (COM) by a short-circuit line.

Configuration

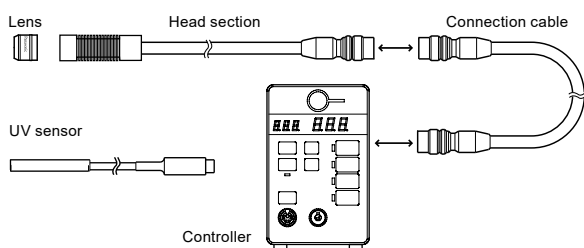

Four heads can be simultaneously connected to one controller.

Panasonic original LED provides a UV intensity* of 4,600 mW/cm².

* Wavelength: 385 nm 0.015 mil, Irradiation distance: 10 mm 0.394 in
Based on our company's measurement standards. Values are typical, but not guaranteed.

The wavelength 365 nm 0.014 mil type and 385 nm 0.015 mil type are available.



Air cooling method

Water cooling equipment is not required since the unit is fan-cooled.
Compact equipment makes installation easy.

■ **Illumination profile (Example)** Note: The intensity profiles shown are representative values, not guaranteed values.

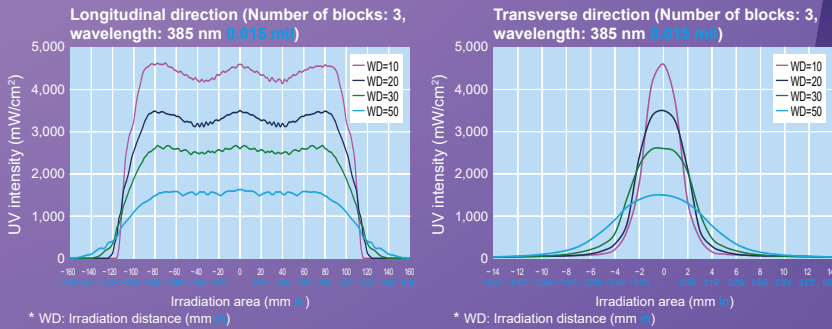

Multiple Size Variations

Six sizes are available for use in various applications.

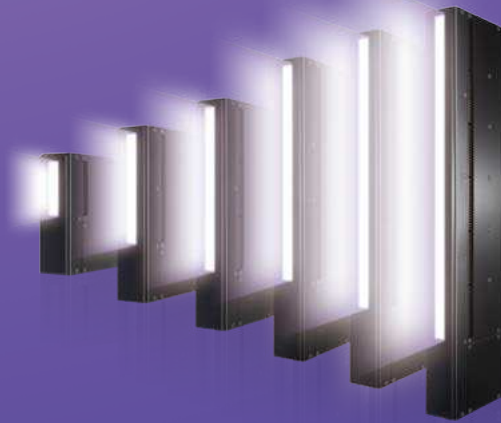

Compact Size Makes Installation Easier

This compact equipment can be installed in a small space. Provides greater flexibility in choosing the installation location



Why is the UV intensity high?

Reason 1 The LED's capabilities are maximized by its cooling structure and a small size was also achieved.

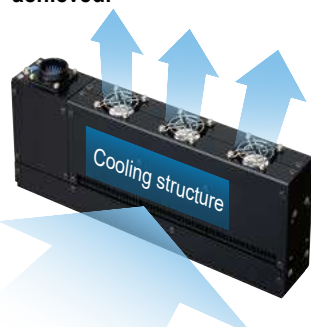

Reason 2 It has high light density due to its optical design. Further, it also enables long distance irradiation.

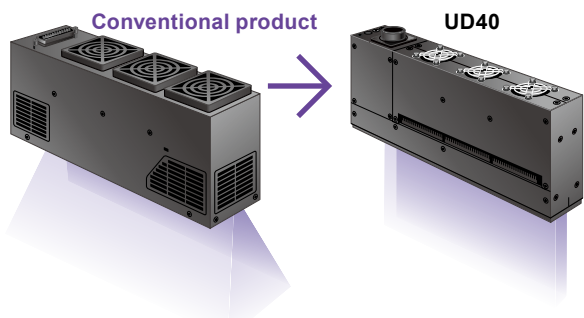

Flexible UV Irradiation Patterns

Block-level UV intensity control

UV irradiation can be controlled separately for each block in the head. This enables UV irradiation according to the workpiece shape and also reduces power consumption by turning off the LEDs where UV irradiation is not needed.

UV irradiation pattern example (6 blocks)

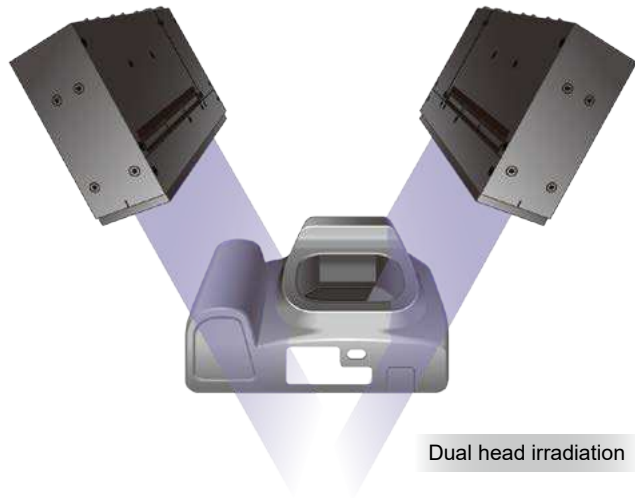
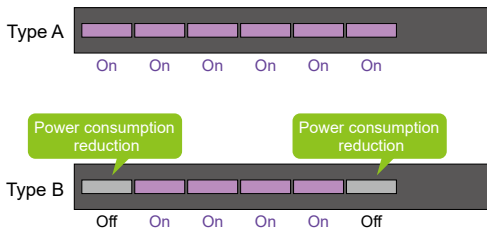

UV Irradiation Stability

No more resin curing defects or adhesion errors

Temperature feedback control Panasonic's original

Provides UV irradiation accuracy within $\pm 5\%$.
(at 80% UV intensity setting)

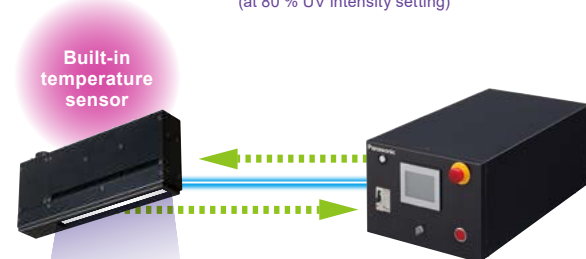

Generally, an increase in LED temperature reduces the UV irradiation output. However, the UD40 series employs a Panasonic original head cooling mechanism to suppress temperature increases. Further, a temperature sensor is built into the head to constantly monitor and feed back temperature information. This has resulted in a superb UV irradiation stability within $\pm 5\%$ for output up to 80%. This is ideal for high quality, precise adhesion applications.

Typical characteristics (25 °C 77 °F atmosphere)

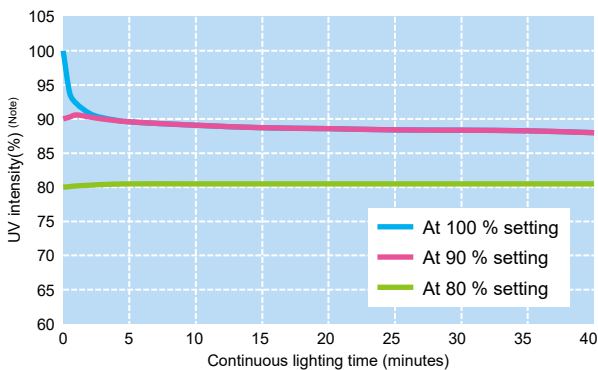

Note: An output setting of 100% is indicated as 100.

External Access Control

Control UV irradiation from an external device. UV irradiation can be applied only during the required time period.

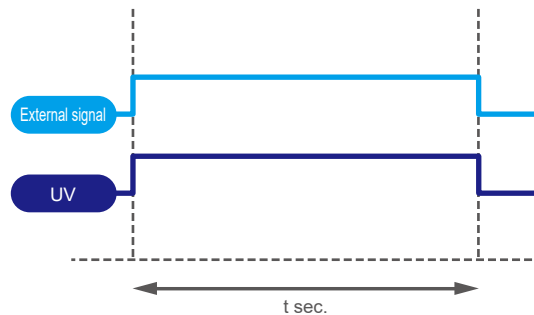
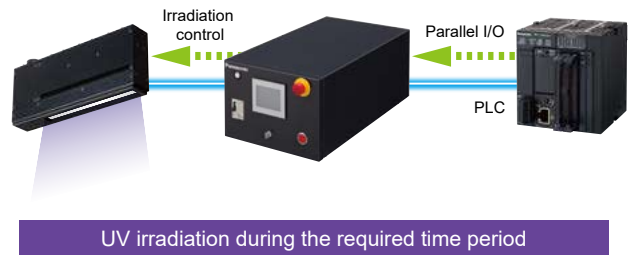

UV irradiation continues during the time period (t sec.) that the external signal is on. UV irradiation stops when the signal is turned off.

UV irradiation from the head can be controlled using a parallel signal from a PLC or other external device.

Note: From detection of external signal ON, up to about 500 msec is required for UV illumination to reach the set value (necessary for overcurrent protection).

Operating Time and Temperature Display Functions

Notification of LED replacement period and abnormal temperature

The number of hours of lighting is counted for each LED block in the head. When a specific number of hours is reached, the LED replacement period is indicated through the controller's external output and panel display. In addition, because the head has a built-in temperature sensor, the LED temperature during operation can be displayed. If an abnormal temperature is detected, the controller sends a warning through its external output and panel display. These functions ensure safety and improve productivity.

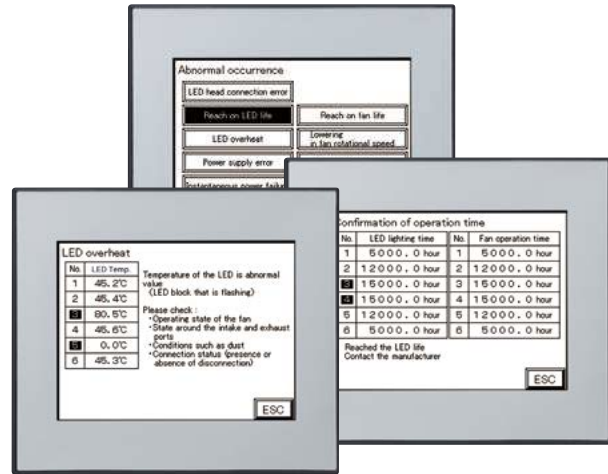

Long-life, Economical LED Type

LED type makes frequent replacement of service parts unnecessary.

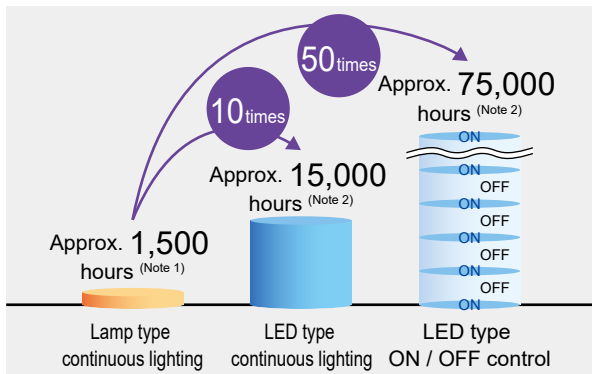

The LED type features extremely long light-source life span compared to the lamp type. As compared to the estimated lamp life span of 1,500 hours (Note 1), the estimated LED life span is 15,000 hours (Note 2).

Furthermore, unlike the lamp type that remains on at all times, the LED type can be turned on only when UV irradiation is needed. If the irradiation on/off time ratio is 1:4 (process takt time = 5, irradiation time = 1), this calculates to a life span of approximately 75,000 hours (Note 2), which can drastically reduce running cost and maintenance man-hours.

Notes: 1) Our straight tube type
2) At an ambient operating temperature of +25 °C +77 °F

Low Power Consumption at 100 W per LED Block

Reduces running cost and CO₂

Even when six blocks in a single head are turned on, the maximum power consumption is 650 W (at 200 V AC). This effectively reduces power consumption and CO₂ emission. Since less heat is generated than the lamp type, even when the system is used in a small clean room, the increase in room temperature is small. This reduces the power needed for air conditioning.

Eco product compliant with CE, RoHS, etc.



Unlike lamp type, LED type heads do not contain mercury. UD40 conform to CE Marking, RoHS Directive, and Management Methods for Controlling Pollution by Electronic Information Products (China RoHS), ensuring environmentally safe use. (Please follow the proper industrial waste disposal procedures.)

Proposal

Switching from lamp type UD40

Long term light source
Exhaust air duct not required
Space-saving
Power saving

Switching from spot type connection style to line type UD40

UV intensity distribution of spot type (Typical example)
ANUJ6180 (standard type) + ANUJ6450S (wavelength: 365 nm 0.014 mil, irradiation distance 20 mm 0.787 in)

UV intensity distribution of line type (Typical example)
UD40 (Number of blocks: 2, wavelength: 365 nm 0.014 mil, irradiation distance: 30 mm 1.181 in)

- High UV intensity
- Long distance irradiation is also possible
- Improvement in UV intensity uniformity

Product Components

With single head

■ Number of head blocks: 1 to 3

·Head 

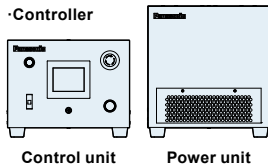

■ Number of head blocks: 4 to 6

·Head 

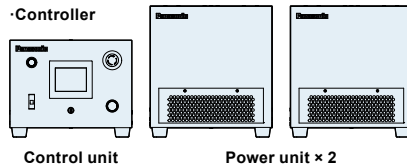

With dual head

■ Number of blocks in head 1: 1 to 3, number of blocks in head 2: 1 to 3

·Head 

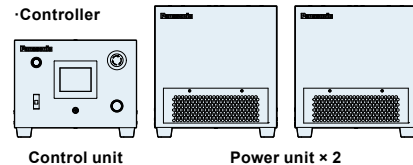

With dual head

■ Number of blocks in head 1: 1 to 3, number of blocks in head 2: 4 to 6

■ Number of blocks in head 1: 4 to 6, number of blocks in head 2: 1 to 3

·Head 

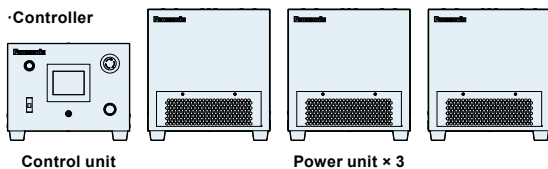

■ Number of blocks in head 1: 4 to 6, number of blocks in head 2: 4 to 6

·Head 

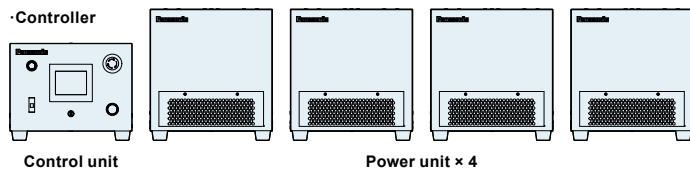

Specifications

Common head specifications

Item	Head part No. Wavelength: 365 nm 0.014 mil Wavelength: 385 nm 0.015 mil	ANUD4A111	ANUD4A211	ANUD4A311	ANUD4A411	ANUD4A511	ANUD4A611
		ANUD4B111	ANUD4B211	ANUD4B311	ANUD4B411	ANUD4B511	ANUD4B611
Number of blocks		1	2	3	4	5	6
Light source		365 nm ±10 nm 0.014 mil ±0.0004 mil / 385 nm ±10 nm 0.015 mil ±0.0004 mil					
Peak irradiation intensity	Irradiation distance: 10 mm 0.394 in	2,100 mW/cm ² (Wavelength: 365 nm 0.014 mil) / 2,500 mW/cm ² (Wavelength: 385 nm 0.015 mil)					
Initial guaranteed value ^(Note 1)	Irradiation distance: 30 mm 1.181 in	1,100 mW/cm ² (Wavelength: 365 nm 0.014 mil) / 1,400 mW/cm ² (Wavelength: 385 nm 0.015 mil)					
Peak irradiation intensity	Irradiation distance: 10 mm 0.394 in	4,200 mW/cm ² (Wavelength: 365 nm 0.014 mil) / 4,600 mW/cm ² (Wavelength: 385 nm 0.015 mil)					
Typical value ^(Note 2)	Irradiation distance: 30 mm 1.181 in	2,300 mW/cm ² (Wavelength: 365 nm 0.014 mil) / 2,600 mW/cm ² (Wavelength: 385 nm 0.015 mil)					
Effective irradiation width ^(Note 2)	Irradiation distance: 10 mm 0.394 in	36 mm 1.417 in	108 mm 4.252 in	180 mm 7.087 in	252 mm 9.921 in	324 mm 12.756 in	396 mm 15.591 in
	Irradiation distance: 30 mm 1.181 in	16 mm 0.630 in	88 mm 3.465 in	160 mm 6.299 in	232 mm 9.134 in	304 mm 11.968 in	376 mm 14.803 in
Estimated head life expectancy ^(Note 2)		15,000 hours (70 % for initial UV intensity)					
Ambient operating temperature / ambient operating humidity		0 to +35 °C +32 to +95 °F / 30 to 85 % RH (no dew condensation or icing allowed)					
Storage temperature / storage humidity		-10 to +60 °C +14 to +140 °F / 30 to 85 % RH (no dew condensation or icing allowed)					
Cooling method		Fan-forced air cooling					
Outer finishing		Matte black painting					
Accessories		Power supply wiring connector *Connection cable not supplied. If only a head is purchased, please also prepare a constant-current power supply for the LED, a constant-voltage power supply for the fan and connection cable, etc.					

Notes: 1) Based on our company's measurement standards. Values are initial guaranteed values, but not representative values.

2) Based on our company's measurement standards. Values are typical, but not guaranteed.

Common controller specifications

Item	Controller part No.	ANUD4S□
Input supply voltage		1ø 200 to 240 V AC
Input supply frequency		50 to 60 Hz
AC inlet		Terminal block (terminal block screw diameter: ø4 mm ø0.016 in) ^(Note 1)
No. of irradiation program patterns		32 patterns ^(Note 2)
Display, setting, operation		Display, setting, operation from the touch screen
External control	Type	Parallel I/O (D-Sub37) ^(Note 3)
	External input	LED lighting, program selection, LED block individual lighting, local or remote selection, external emergency stop
	External output	Equipment power ON, irradiation preparation complete, irradiating, alert, error, main unit emergency stop
Dimming control ^(Note 2)		50 to 100 % (in increments of 1 %)
LED temperature feedback		A function that senses the temperature of the LED head section and maintains constant UV intensity
Ambient operating temperature / ambient operating humidity		0 to +35 °C +32 to +95 °F / 30 to 85 % RH (no dew condensation or icing allowed)
Storage temperature / storage humidity		-10 to +60 °C +14 to +140 °F / 30 to 85 % RH (no dew condensation or icing allowed)
Cooling method		Control unit: Fan-less natural air cooling, Power unit: Fan-forced air cooling
Configuration		Separation of control unit equipped with PLC and power supply for LED lighting
Outer finishing		Matte black painting
Accessories	Control unit	Power key, D-Sub37 connector
	Power unit	Signal cable (1 m 3.281 ft), AC connection cable (1 m 3.281 ft), LED head connection cable (5 m 16.404 ft)

Notes: 1) Prepare a separate power supply cable (AC supply cable) with a diameter appropriate for the maximum input current.

2) Setting from the touch screen.

3) Prepare a separate cable for connecting to the D-Sub37 connector.

Specifications

Individual specifications

With single head

Number of blocks		1	2	3	4	5	6
Head part No.	Wavelength: 365 nm 0.014 mil	ANUD4A111	ANUD4A211	ANUD4A311	ANUD4A411	ANUD4A511	ANUD4A611
	Wavelength: 385 nm 0.015 mil	ANUD4B111	ANUD4B211	ANUD4B311	ANUD4B411	ANUD4B511	ANUD4B611
Controller part No.		ANUD4S10	ANUD4S20	ANUD4S30	ANUD4S40	ANUD4S50	ANUD4S60
No. of control units		1					
No. of power units		1			2		
Maximum input current		1 A	2 A	3 A	4 A	5 A	6 A
Maximum power consumption		150 W	250 W	350 W	450 W	550 W	650 W
Weight ^(Note)	Head	1.3 kg approx.	1.8 kg approx.	2.3 kg approx.	3.0 kg approx.	3.5 kg approx.	4.0 kg approx.
	Control unit	10 kg approx.					
	Power unit-1	10 kg approx.	12 kg approx.	14 kg approx.			
	Power unit-2	—			10 kg approx.	12 kg approx.	14 kg approx.

Note: Excluding connectors and cables.

With dual head (Combinations of [1 to 6 blocks in Head 1] and [1 to 3 blocks in Head 2])

		Number of blocks (Head 1)							
		1	2	3	4	5	6		
Number of blocks (Head 2)	1	Controller part No.	ANUD4S11	ANUD4S21	ANUD4S31	ANUD4S41	ANUD4S51	ANUD4S61	
		No. of control units	1						
		No. of power units	2			3			
		Maximum input current	2 A	3 A	4 A	5 A	6 A	7 A	
		Maximum power consumption	250 W	350 W	450 W	550 W	650 W	750 W	
		Weight ^(Note)	Head 1	1.3 kg approx.	1.8 kg approx.	2.3 kg approx.	3.0 kg approx.	3.5 kg approx.	4.0 kg approx.
	Head 2		1.3 kg approx.						
	Control unit		10 kg approx.						
	Power unit-1		10 kg approx.	12 kg approx.	14 kg approx.				
	Power unit-2		—			10 kg approx.	12 kg approx.	14 kg approx.	
	2	Controller part No.	ANUD4S12	ANUD4S22	ANUD4S32	ANUD4S42	ANUD4S52	ANUD4S62	
			No. of control units	1					
			No. of power units	2			3		
			Maximum input current	3 A	4 A	5 A	6 A	7 A	8 A
			Maximum power consumption	350 W	450 W	550 W	650 W	750 W	850 W
			Weight ^(Note)	Head 1	1.3 kg approx.	1.8 kg approx.	2.3 kg approx.	3.0 kg approx.	3.5 kg approx.
		Head 2		1.8 kg approx.					
		Control unit		10 kg approx.					
Power unit-1		10 kg approx.		12 kg approx.	14 kg approx.				
Power unit-2		—			10 kg approx.	12 kg approx.	14 kg approx.		
3		Controller part No.	ANUD4S13	ANUD4S23	ANUD4S33	ANUD4S43	ANUD4S53	ANUD4S63	
			No. of control units	1					
	No. of power units		2			3			
	Maximum input current		4 A	5 A	6 A	7 A	8 A	9 A	
	Maximum power consumption		450 W	550 W	650 W	750 W	850 W	950 W	
	Weight ^(Note)		Head 1	1.3 kg approx.	1.8 kg approx.	2.3 kg approx.	3.0 kg approx.	3.5 kg approx.	4.0 kg approx.
Head 2		2.3 kg approx.							
Control unit		10 kg approx.							
Power unit-1		10 kg approx.	12 kg approx.	14 kg approx.					
Power unit-2		—			10 kg approx.	12 kg approx.	14 kg approx.		
3	Power unit-3	14 kg approx.							

Note: Excluding connectors and cables.

Specifications

Individual specifications

With dual head (Combinations of [1 to 6 blocks in Head 1] and [4 to 6 blocks in Head 2])

		Number of blocks (Head 1)							
		1	2	3	4	5	6		
Number of blocks (Head 2)	4	Controller part No.	ANUD4S14	ANUD4S24	ANUD4S34	ANUD4S44	ANUD4S54	ANUD4S64	
		No. of control units	1						
		No. of power units	3			4			
		Maximum input current	5 A	6 A	7 A	8 A	9 A	10 A	
		Maximum power consumption	550 W	650 W	750 W	850 W	950 W	1,050 W	
		Weight ^(Note)	Head 1	1.3 kg approx.	1.8 kg approx.	2.3 kg approx.	3.0 kg approx.	3.5 kg approx.	4.0 kg approx.
			Head 2	3.0 kg approx.					
			Control unit	10 kg approx.					
			Power unit-1	10 kg approx.	12 kg approx.	14 kg approx.			
	Power unit-2		—			10 kg approx.	12 kg approx.	14 kg approx.	
	Power unit-3		14 kg approx.						
	Power unit-4	10 kg approx.							
	5	Controller part No.	ANUD4S15	ANUD4S25	ANUD4S35	ANUD4S45	ANUD4S55	ANUD4S65	
		No. of control units	1						
		No. of power units	3			4			
		Maximum input current	6 A	7 A	8 A	9 A	10 A	11 A	
		Maximum power consumption	650 W	750 W	850 W	950 W	1,050 W	1,150 W	
		Weight ^(Note)	Head 1	1.3 kg approx.	1.8 kg approx.	2.3 kg approx.	3.0 kg approx.	3.5 kg approx.	4.0 kg approx.
			Head 2	3.5 kg approx.					
			Control unit	10 kg approx.					
			Power unit-1	10 kg approx.	12 kg approx.	14 kg approx.			
Power unit-2	—			10 kg approx.	12 kg approx.	14 kg approx.			
Power unit-3	14 kg approx.								
Power unit-4	12 kg approx.								
6	Controller part No.	ANUD4S16	ANUD4S26	ANUD4S36	ANUD4S46	ANUD4S56	ANUD4S66		
	No. of control units	1							
	No. of power units	3			4				
	Maximum input current	7 A	8 A	9 A	10 A	11 A	12 A		
	Maximum power consumption	750 W	850 W	950 W	1,050 W	1,150 W	1,250 W		
	Weight ^(Note)	Head 1	1.3 kg approx.	1.8 kg approx.	2.3 kg approx.	3.0 kg approx.	3.5 kg approx.	4.0 kg approx.	
		Head 2	4.0 kg approx.						
		Control unit	10 kg approx.						
		Power unit-1	10 kg approx.	12 kg approx.	14 kg approx.				
Power unit-2		—			10 kg approx.	12 kg approx.	14 kg approx.		
Power unit-3		14 kg approx.							
Power unit-4	14 kg approx.								

Note: Excluding connectors and cables.

Dimensions (Unit: mm in)

ANUD4A□ ANUD4B□

Heads

■ Number of blocks: 1 to 3

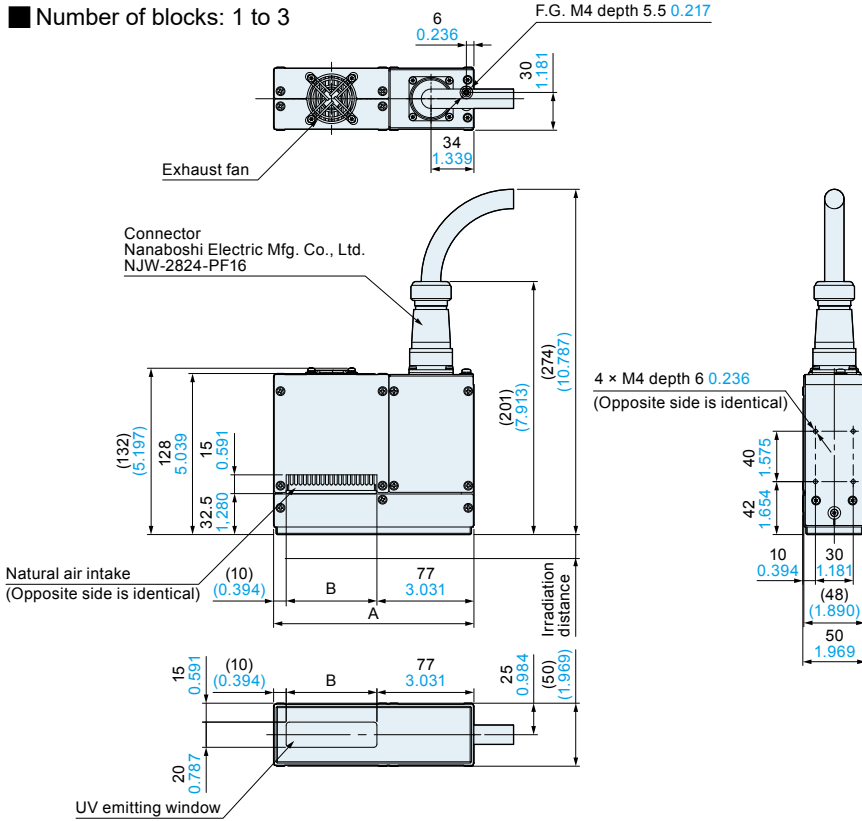

Head Part No.	Wavelength: 365 nm 0.014 mil	ANUD4A111	ANUD4A211	ANUD4A311
	Wavelength: 385 nm 0.015 mil	ANUD4B111	ANUD4B211	ANUD4B311
Number of blocks		1	2	3
Effective irradiation width	Irradiation distance: 10 mm 0.394 in	36 1.417	108 4.252	180 7.087
	Irradiation distance: 30 mm 1.181 in	16 0.630	88 3.465	160 6.299
Width		50 1.969		
External dimensions	Height	(142 5.591)		
	(with receptacle, without connector and cable)			
	A (Length)	159 6.260	231 9.094	303 11.929
B		72 2.835	144 5.669	216 8.504

■ Number of blocks: 4 to 6

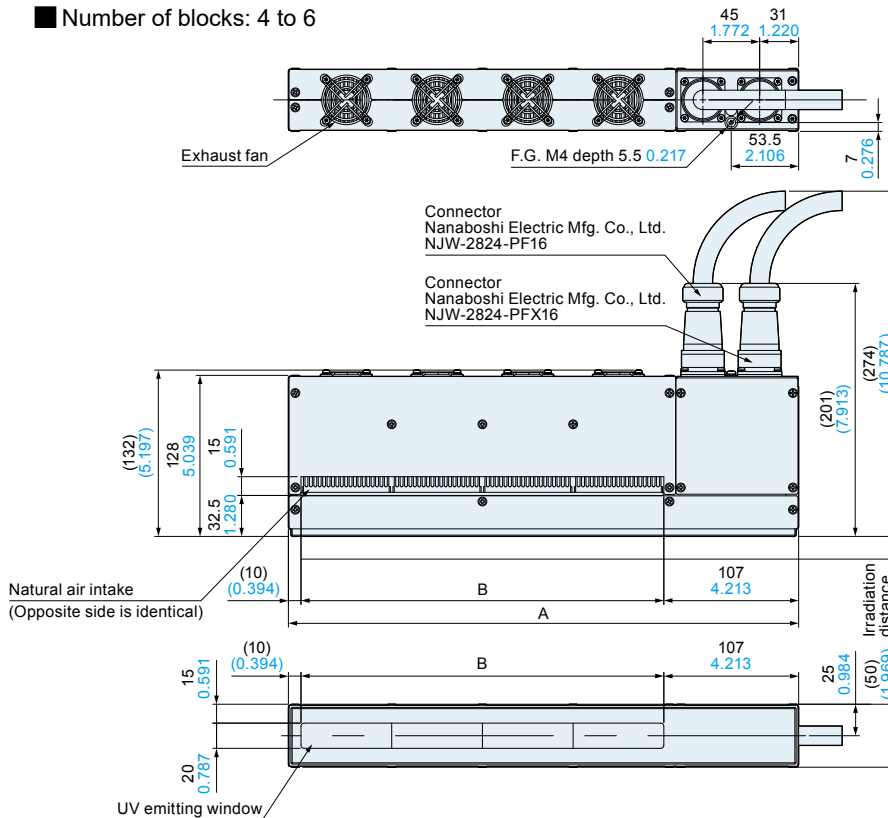

Head Part No.	Wavelength: 365 nm 0.014 mil	ANUD4A411	ANUD4A511	ANUD4A611
	Wavelength: 385 nm 0.015 mil	ANUD4B411	ANUD4B511	ANUD4B611
Number of blocks		4	5	6
Effective irradiation width	Irradiation distance: 10 mm 0.394 in	252 9.921	324 12.756	396 15.591
	Irradiation distance: 30 mm 1.181 in	232 9.134	304 11.968	376 14.803
Width		50 1.969		
External dimensions	Height	(142 5.591)		
	(with receptacle, without connector and cable)			
	A (Length)	405 15.945	477 18.779	549 21.614
B		288 11.339	360 14.173	432 17.008

Dimensions (Unit: mm in)

ANUD4S□ Controllers

Control unit

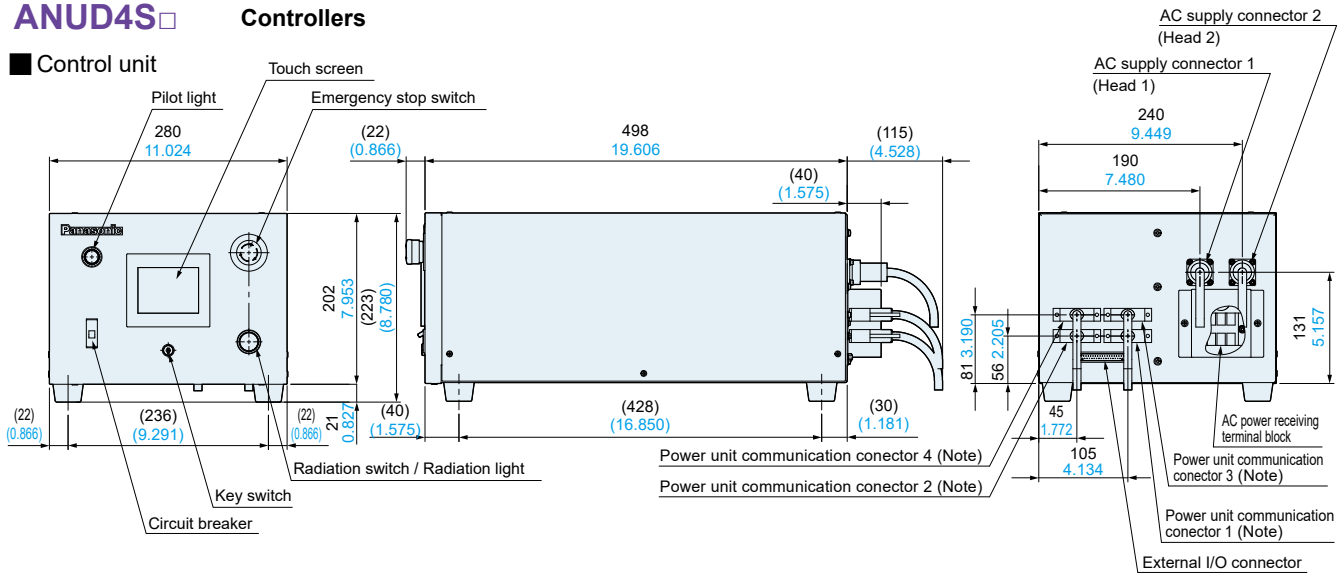

Note: The position and number of power unit communication connectors depend on the number of connected power units. See the chart on the right for the corresponding models. (Figure above shows an example of using 4 power units)

Power unit communication connector availability chart

	Controller part No.						
	ANUD4S10	ANUD4S40	ANUD4S11	ANUD4S14	ANUD4S41	ANUD4S44	
Power unit communication connector	ANUD4S20	ANUD4S50	ANUD4S12	ANUD4S15	ANUD4S42	ANUD4S45	
	ANUD4S30	ANUD4S60	ANUD4S13	ANUD4S16	ANUD4S43	ANUD4S46	
			ANUD4S21	ANUD4S24	ANUD4S51	ANUD4S54	
			ANUD4S22	ANUD4S25	ANUD4S52	ANUD4S55	
			ANUD4S23	ANUD4S26	ANUD4S53	ANUD4S56	
			ANUD4S31	ANUD4S34	ANUD4S61	ANUD4S64	
			ANUD4S32	ANUD4S35	ANUD4S62	ANUD4S65	
			ANUD4S33	ANUD4S36	ANUD4S63	ANUD4S66	
	No. of power units	1	2	2	3	3	4
	Power unit communication connector 1	Available	Available	Available	Available	Available	Available
Power unit communication connector 2	None	Available	None	None	Available	Available	
Power unit communication connector 3	None	None	Available	Available	Available	Available	
Power unit communication connector 4	None	None	None	Available	None	Available	

Power unit

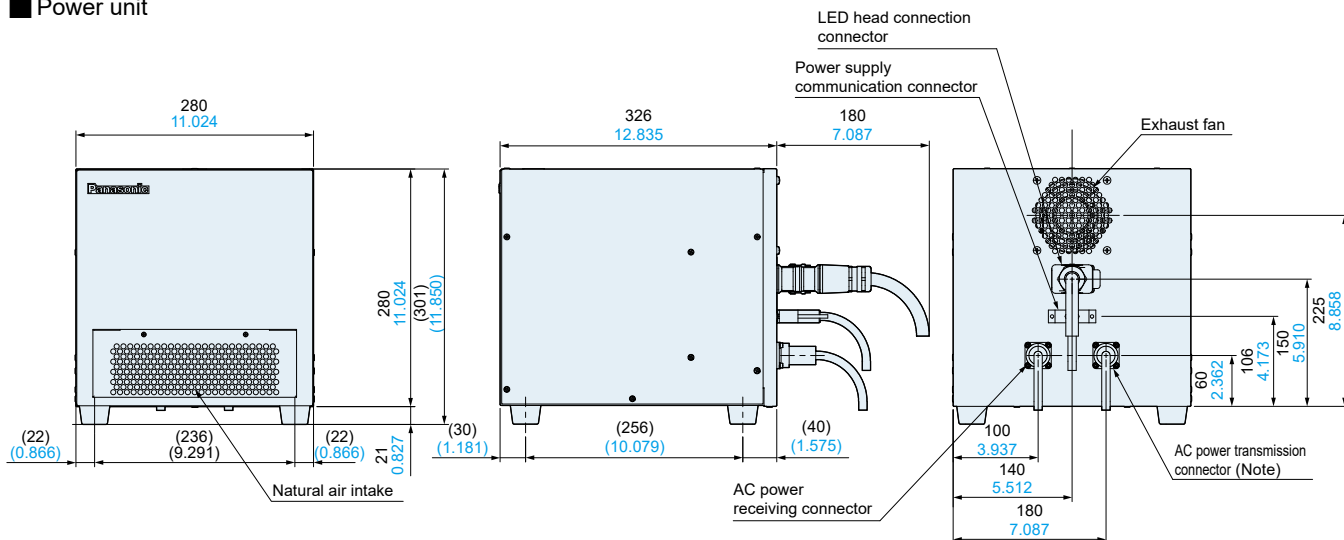

Note: Whether an AC transmission connector is used depends on the controller model. See the chart on the right for information on which models use AC transmission connectors. (Figure above shows an example of using an AC transmission connector)

AC power transmission connector availability chart —: Power unit not available

	Controller part No.						
	ANUD4S10	ANUD4S40	ANUD4S11	ANUD4S14	ANUD4S41	ANUD4S44	
AC transmission connector used / not used	ANUD4S20	ANUD4S50	ANUD4S12	ANUD4S15	ANUD4S42	ANUD4S45	
	ANUD4S30	ANUD4S60	ANUD4S13	ANUD4S16	ANUD4S43	ANUD4S46	
			ANUD4S21	ANUD4S24	ANUD4S51	ANUD4S54	
			ANUD4S22	ANUD4S25	ANUD4S52	ANUD4S55	
			ANUD4S23	ANUD4S26	ANUD4S53	ANUD4S56	
			ANUD4S31	ANUD4S34	ANUD4S61	ANUD4S64	
			ANUD4S32	ANUD4S35	ANUD4S62	ANUD4S65	
			ANUD4S33	ANUD4S36	ANUD4S63	ANUD4S66	
	No. of power units	1	2	2	3	3	4
	Power unit-1	None	Available	None	None	Available	Available
Power unit-2	—	None	—	—	None	None	
Power unit-3	—	—	None	Available	None	Available	
Power unit-4	—	—	—	None	—	None	

Energy-efficient mode will cut power consumption by maximum of 15 % when the irradiation is off. Also featuring high-accuracy auto-tuning function



High-efficiency UV irradiation

Eco mode reduces power consumption.

The Eco mode cuts the standby power consumption by a maximum of 15 % while the irradiation is off (the shutter is closed), contributing to the running costs (electricity charge). Compatible with a wide range of power supply voltages from 100 to 240 V AC for worldwide use.

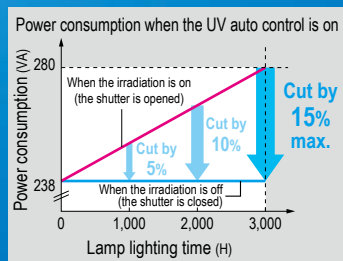

Surface tackiness can be quickly eliminated.

The development and adoption of our unique special mirror that allows for the effective irradiation with short wavelengths enables the quick elimination of surface stickiness caused during curing. The irradiation time can also be reduced, decreasing the temperature rise of workpieces.

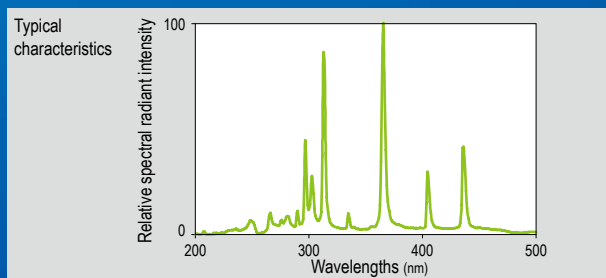

ANUP5001F heat ray cut filter prevents temperature rises in the irradiation unit.

The use of the filter is recommended especially for heat-sensitive workpieces. You can reduce temperature rises in the irradiation unit by attaching a heat reflecting filter depending on the type of workpiece.

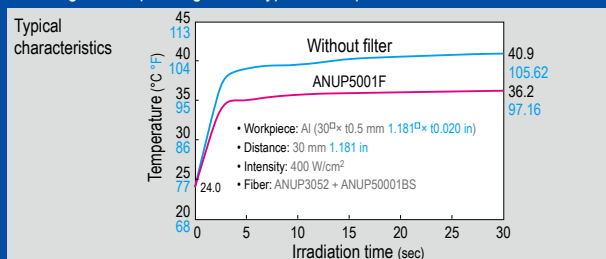

Stable UV irradiation performance

UV auto control function automatically compensates for the UV intensity

This function increases the electrical power applied to the lamp according to the total irradiation time of the lamp to compensate for the UV intensity decrease, maintaining stable UV irradiation until the end of the lamp life.

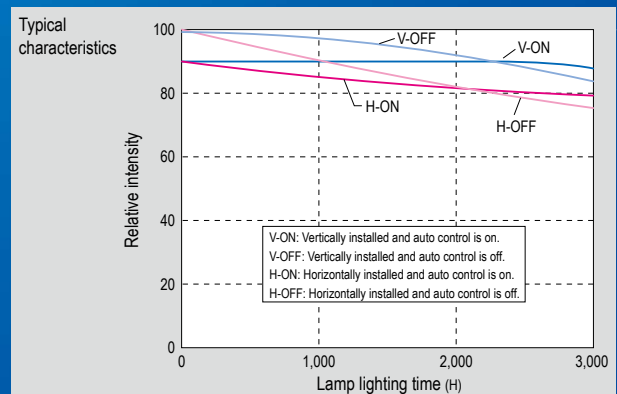

Significantly higher reliability for bonding and fixing



Slim UV sensor

The UV sensor for measuring irradiation intensity enables auto-turning in high-accuracy.



The UV intensity can be relative measured^(Note 1) at the actual position by using the slim UV sensor. It can also automatically adjust the UV intensity to the preset level. Since the sensor only has 5 mm (0.197 in) thickness, which is similar to the workpiece, the intensity measurement is possible without removing the system from the production line, facilitating

high-accuracy setting and in-line condition optimization. The UV intensity can be checked and adjusted at real time, enhancing the bonding and fixing reliability.

Notes: 1) UV intensity can be measured as a relative value.
 2) Because sensitivity adjustment of the UV sensor is carried out at 365 nm single wavelength, depending on the spectral sensitivity characteristics of the UV resin being used, it may not be possible to fully control the curing process. For more information, please consult us.

Stable UV irradiation performance

Programmable irradiation function

This function prevents curing distortion and enables high-quality precision bonding.

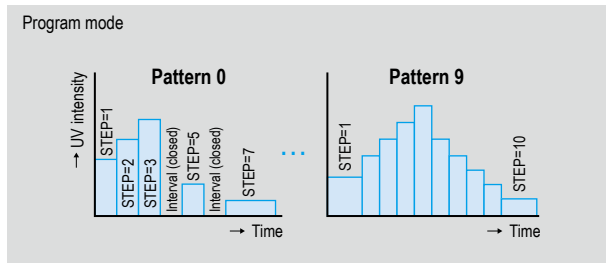

The irradiation can be programmed to controls the irradiation power and time depending on the resin and curing application, supporting high-quality and high-precision bonding with minimum cure shrinkage. In addition to the simple irradiation mode which irradiation is continuously performed at a constant intensity, up to 10 steps 10 patterns can be set. This includes the step-up mode which the intensity is changed over time and the interval mode which irradiation is performed at specified intervals.

Digital setting allows for consistency of set values from operator to operator.

The irradiation power can be finely set in the range of 0 to 100 % in increments of 0.5 %. The actual UV irradiation intensity is approximately proportional to the displayed value, making the setting work easier and more accurate.

Interchangeability with ANUP5204

The wavelength distribution (typical characteristics) of **UP50** is identical to **ANUP5204**, our existing model. The replacement lamp, the **ANUPS204**, is also the same as that for the **ANUP5204**.

Specifications

Part No.	ANUP50
Power supply	90 to 264 V AC 50 / 60 Hz 280 VA
Lamp Part No.	ANUPS204
Lamp	200 W mercury xenon lamp, preset quickly-attachable type Notes: 1) Average life of 3,000 hours: Ratio to the initial UV intensity -- 80% or higher in a vertical position, 70 % or higher in a horizontal position (when the auto control function is off) 2) Guaranteed life: 2,000 hours
Ambient temperature / ambient humidity	+10 to +40 °C +50 to +104 °F / Max. 80 % RH (no condensation)
Accessories	Lamp (ANUPS204) Power cord (3 m 9.843 ft, 100 V AC compatible, plug with 2-pole ground)

Easy to install

Can be placed either vertically or horizontally .

The unit can be placed in either a vertical position that makes the footprint smaller or a horizontal position that allows stacking other units.



Long life, quickly-attachable lamp

The average lamp life is 3,000 hours (guaranteed life: 2,000 hours^(Note)). The lamp can be easily replaced with a single operation and does not require an optical axis adjustment.

Note: Ratio to the initial UV intensity -- 80 % or higher in vertical placement, 70 % or higher in horizontal placement



Two lens unit models for short and long range converging

The two lens unit models, one for short range and the other for long range converging, cover a variety of applications and workpieces.

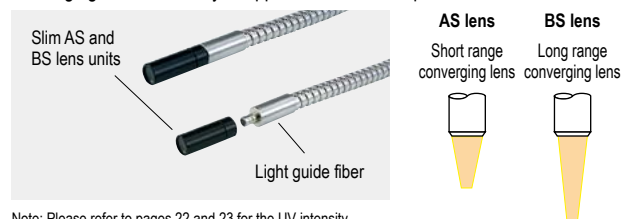

Note: Please refer to pages 22 and 23 for the UV intensity distribution data.

UV irradiation	UV intensity adjustment by digital setting (0 to 100 %, in increments of 0.5 %) UV auto control Programmable irradiation (10 steps in each of 10 patterns) External signal control: Turning the lamp on/off, manual opening/closing of the shutter, starting programmed pattern irradiation, starting timer-controlled irradiation, and executing calibration
Shutter	Electronically-controlled shutter using manual or timer-controlled operation
Setting	Digital setting using membrane switches
External signal	Input: Opening/closing the shutter (timer/manual), lighting the lamp Output: Lighting the lamp, stabilizing the lamp light, opening the shutter, outputting error signals, and indicating the lamp life
Dimensions	165 × 201 × 325 mm 6.496 × 7.913 × 12.795 in (Excluding protruding sections)
Weight	8 kg approx.

Note: Please refer to page 22 for the light guide fiber units and other optional parts.

Options

Light guide fiber units

Number of branches	1	2	3	4
Shape				
Bundle diameter: ø3.5 mm ø0.138 in (light outlet end)	ANUP5031	ANUP5032	ANUP5033	ANUP5034
Bundle diameter: ø5 mm ø0.197 in (light outlet end)	ANUP5051	ANUP5052	ANUP5053	ANUP5054
Bundle diameter: ø8 mm ø0.315 in (light outlet end)	ANUP5081			

Note: The custom-made correspondence with the line type light outlet shape is also possible. For more information, please consult us.

Others

Product name	Specifications	Part No.
Lens ^(Note)	Short range converging lens	ANUP5001AS
	Long range converging lens	ANUP5001BS
	Cylindrical lens	Custom-made product
Heat ray cut filter	Reflection type	ANUP5001F
Lamp	For UP50	ANUPS204
Lamp lead wire	For UP50	ANUPS50H2
UV sensor	Slim type (Thickness: 5 mm 0.197 in) (ANUJ38102 is attached.)	ANUJ3800
UV sensor extension cable	Length: 10 m 32.808 ft	ANUJ38110
	Length: 2 m 6.562 ft (Equivalent to the cable attached with ANUJ3800)	ANUJ38102

Note: Please consult us separately for the lens for the ø8 mm ø0.315 in fiber unit.

Dimensions

(Unit: mm in) Excluding the protruding sections

UP50

UP50 Controller

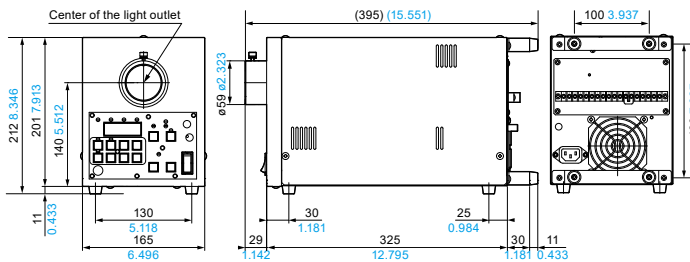

Light guide fiber units

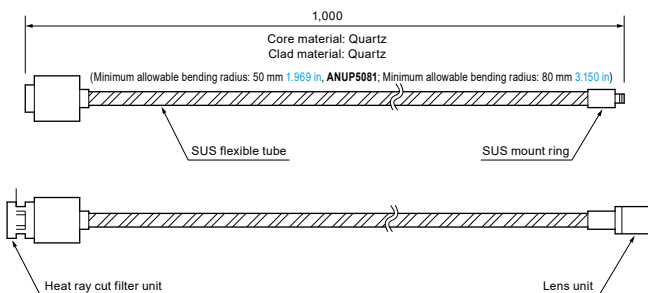

Intensity Profiles

(Typical examples)

Bundle diameter: ø8 mm ø0.315 in, Straight

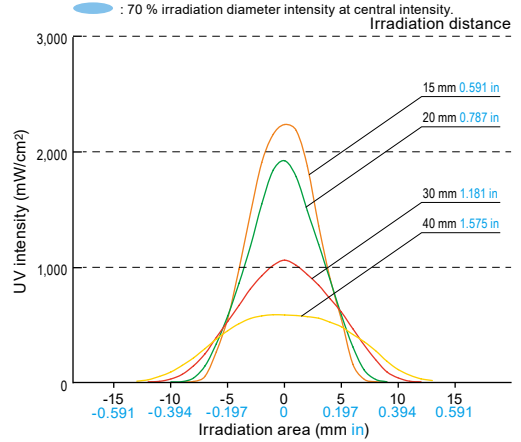
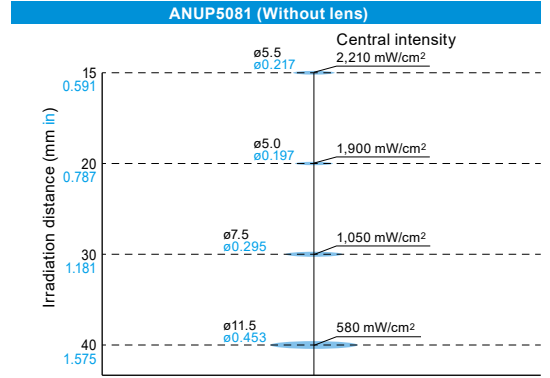

[Rough guide of the relationship between the number of fiber unit branches and the UV intensity ratio] (Irradiation distance: 15 mm 0.591 in, ø1 mm ø0.039 in sensor)

Fiber unit	UV intensity ratio	
	Without lens	With lens
ø5 × 1 branch	100 %	100 %
ø5 × 2 branches	75 %	65 %
ø5 × 3 branches	55 %	53 %
ø5 × 4 branches	50 %	45 %
ø3.5 × 1 branch	100 %	100 %
ø3.5 × 2 branches	80 %	75 %
ø3.5 × 3 branches	62 %	60 %
ø3.5 × 4 branches	57 %	50 %

External control connector (18-pin M3 screw terminal block) terminal layout

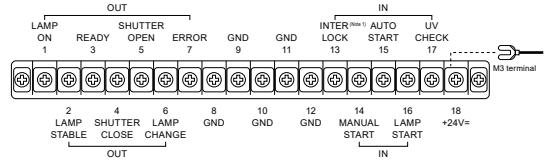

Note: At shipment, for B-contact (allows irradiation when ON), No.13 (INTERLOCK) is connected to No.12 (GND) by a short-circuit line.

Light outlet end shape

	Fiber bundle diameter: ø5 mm ø0.197 in	Fiber bundle diameter: ø3.5 mm ø0.138 in	Fiber bundle diameter: ø8 mm ø0.315 in
Without lens			
For AS with lens and BS lens			

Intensity Profiles (Typical examples)

Bundle diameter: $\varnothing 5 \text{ mm } \varnothing 0.197 \text{ in}$, Straight

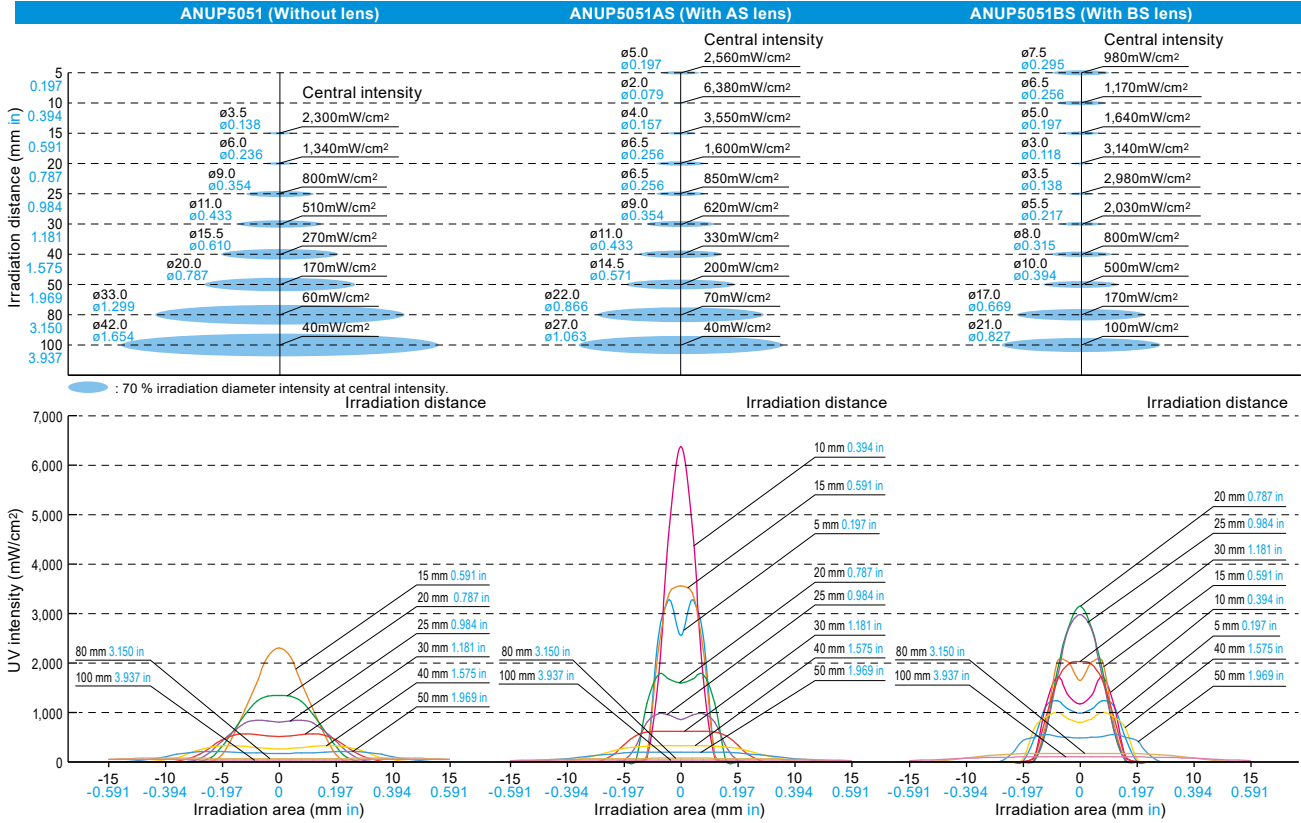

Bundle diameter: $\varnothing 3.5 \text{ mm } \varnothing 0.138 \text{ in}$, Straight

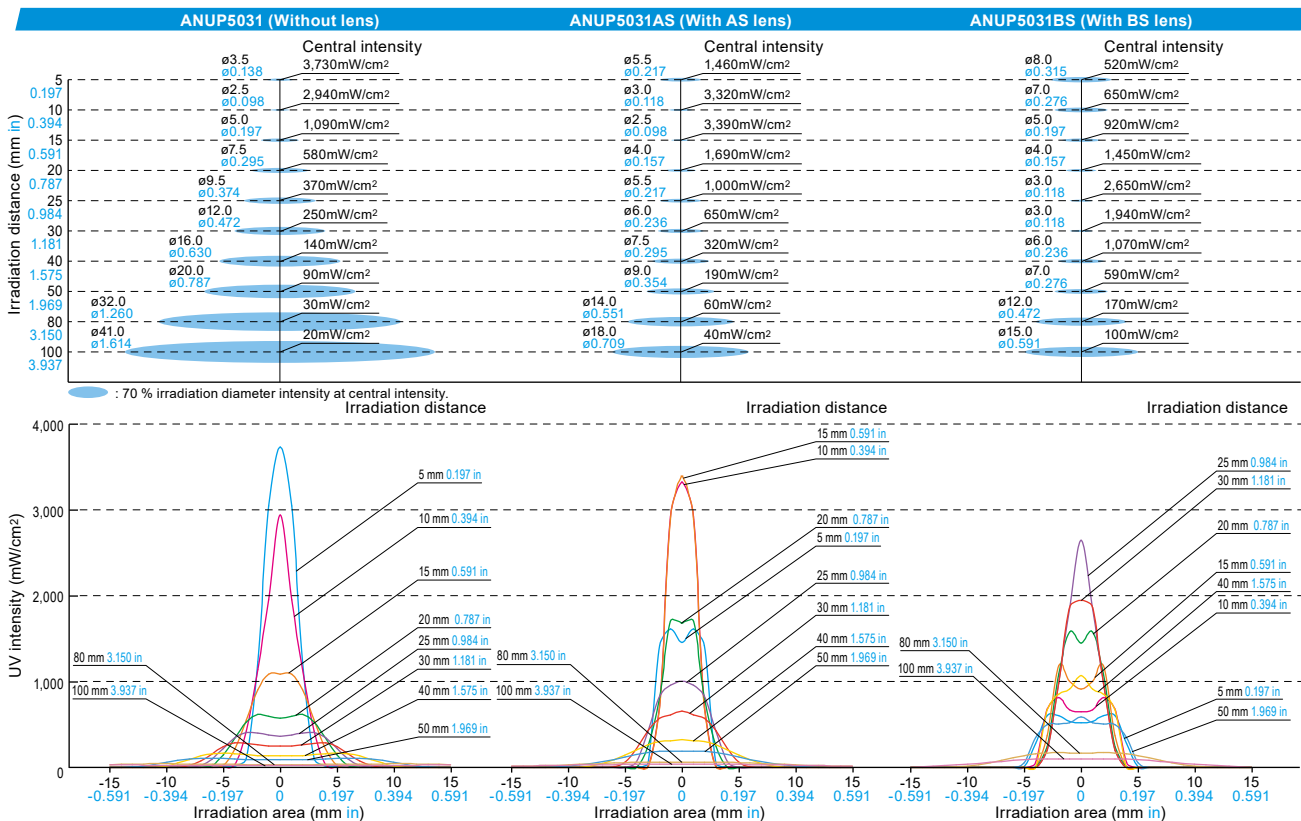

The DICOOL optical mirror, Metal halide lamp, and UV auto control function supports customer needs.

Ideal for UV irradiation of a variety of workpieces.

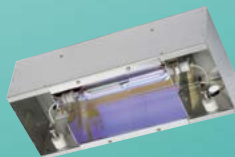

The tube types are order made to customer specifications. For more information, please consult us.

High efficiency and high intensity

Functions for this unit has been developed based on lighting and control technologies accumulated over years, including a unique Panasonic light distribution technology (efficient irradiation) and DICOOL optical mirror, which prevents the rise of workpiece temperature. The efficient light distribution allows for high irradiation intensity, significantly enhancing productivity.

UV auto control function for automatic compensation

Our unique UV auto control function automatically compensates for decrease in the irradiation power due to lamp deterioration over time, maintaining a stable UV irradiation until the end of the lamp life.

*For 3 kW and 6 kW models

DICOOL optical mirror (reflection mirror) adopted to prevent temperature rise

Our original DICOOL optical mirror which reflects UV rays only has been adopted. The DICOOL filter which transmits UV rays only can also be installed as an option. These components decrease radiant heat from the lamp and reflection mirror, reducing the workpiece temperature rise by about 40 %. This feature allows for a wider application to heat-sensitive materials. Also it is equipped with a safety system that stops UV irradiation in case of an excessive temperature rise inside the lamp housing.

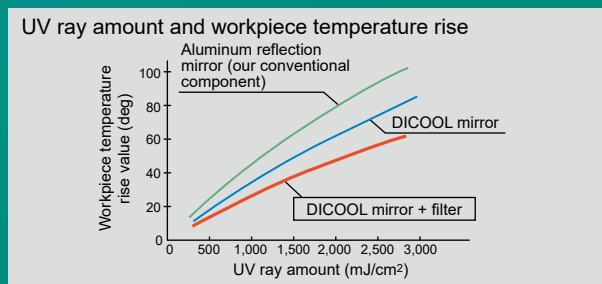
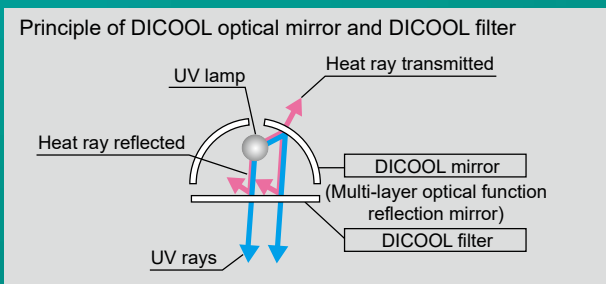

Metal halide lamp developed to significantly increase the thick film curing speed

The metal halide lamp has high luminous efficiency at a wavelength range from 300 to 400 nm, which is about 20 % higher than the efficiency of the conventional UV lamp. This lamp is ideal for bonding, printing, marking, etc. of materials containing a color and materials that require thick film application. Also, the lamp type can be selected according to the type of UV-curable resin or coating film thickness, etc.

Spectral energy distribution

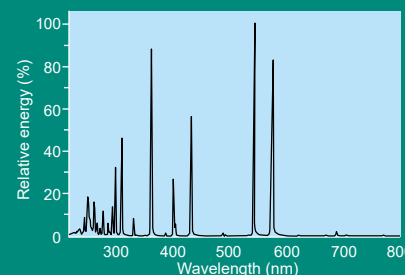
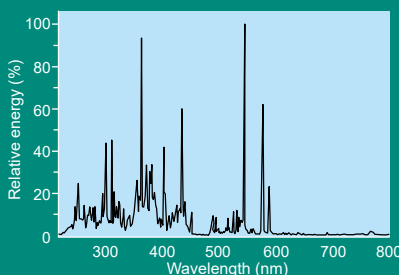

Lamp lineup to cover the resin types and applications

The metal halide lamp is suited for thick-film sealing, coating, bonding, and other general purposes. The UV lamp is suited for applications that require higher surface-curing performance.

A lamp with the best irradiation width can be chosen depending on workpiece size.

Area with 75 % peak intensity is defined as effective irradiation width. The standard effective irradiation width along the lamp width is 50 mm 1.969 in, and the effective irradiation width along the lamp length is as shown in the table below. Areas outside the effective irradiation width are also irradiated with UV rays; however, the irradiation intensity in these areas are lower.

Irradiation width and lamp output intensity

Effective irradiation width (mm in)		Lamp output			Lamp emission length (mm in)
Along the lamp width	Along the lamp length	Lamp output intensity			
		80 W/cm	120 W/cm	160 W/cm	
50 1.969	100 3.937	1.5 kW			125 4.921
50 1.969	150 5.906	3 kW			180 7.087
50 1.969	200 7.874	3 kW			250 9.843
50 1.969	300 11.811	3 kW	6 kW		375 14.764
50 1.969	400 15.748	6 kW			500 19.685
50 1.969	650 25.591	6 kW			750 29.528

Note: The irradiation distance is 130 mm 5.118 in (DICOOL optical mirror).

Width along the lamp width (Workpiece flow along the lamp length)

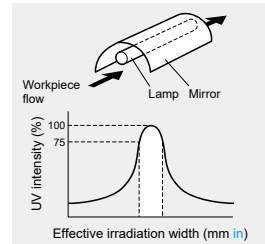

Width along the lamp length (Workpiece flow perpendicular to the lamp length)

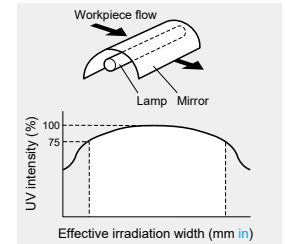

Irradiation intensity (in the lamp width direction)

50 mm 1.969 in wide type (Standard)

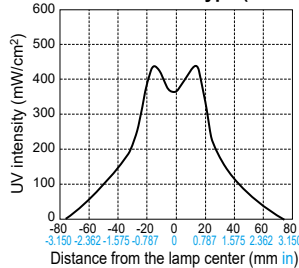

■ Lamp: Metal halide lamp (1.5 kW)
Reflector: DICOOL optical mirror
Distance: 130 mm 5.118 in

The 30 mm 1.181 in wide and 100 mm 3.937 in wide types are also available.

30 mm 1.181 in wide type (custom-made product)

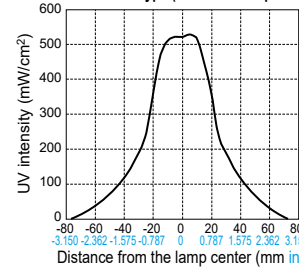

■ Lamp: Metal halide lamp (1.5 kW)
Reflector: DICOOL optical mirror
Distance: 130 mm 5.118 in

100 mm 3.937 in wide type (custom-made product)

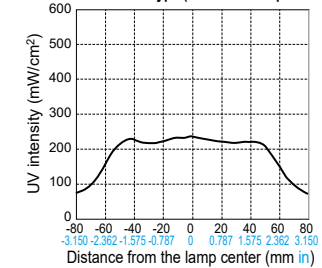

■ Lamp: Metal halide lamp (1.5 kW)
Reflector: DICOOL optical mirror
Distance: 130 mm 5.118 in

Note: The standard type is designed to uniformly irradiate the area of the 50 mm 1.969 in effective irradiation width.

Power supply unit

Function list

Capacity (kW)	Ballast type	UV intensity control function
6	Electronic ballast type (with a UV auto control function)	Continuous intensity control function
3		50 to 100 % range (in 5 % increments)
1.5	Transformer type	With a switch for dimming the intensity to 75 %



Electronic ballast type has a smaller size and 40 % lower energy consumption

Compared with the conventional model (6 kW), the size and weight has been significantly reduced to approx. 2/3 to 1/3. The power supply capacity has been cut by approx. 40 %, achieving significant energy conservation.

Replacement lamps

When replacing a lamp, without fail, use one with the same lamp power and same dimensions as the one being replaced. Metal halide lamps and UV lamps of the same lamp power and same dimensions can be used to provide lighting in the same unit.

- UV-curing lamp types include a UV lamp suited for surface curing and a metal halide lamp ideal for thick-film sealing, coating, and bonding.
- You can choose from a wide selection of lamps to find the optimum type for the application.
- The average lamp life is 1,500 hours. Replace the lamp when the total lighting time reaches about 1,500 hours. (The guaranteed life is 1,000 hours.)

■ Lamp UV rays output retention curve

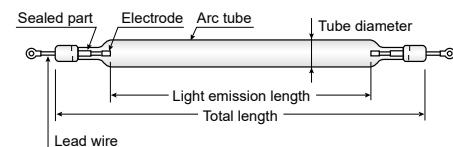
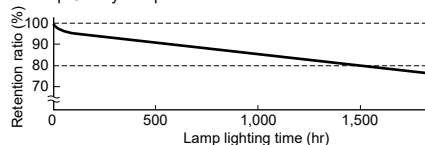

Lamp type	Part No.	Lamp power (kW)	Total length (mm in)	Emission length (mm in)	Tube diameter (mm in)	Effective irradiation width (mm in)	
						Along the lamp length	Along the lamp width
Metal halide lamp	80 W/cm type	ANUM10081	215 8.465	125 4.921	24 0.945	100 3.937	Depends on the irradiation unit
		ANUM30081	475 18.701	375 14.764	24 0.945	300 11.811	
		ANUM60081	850 33.465	750 29.528	24 0.945	650 25.591	
	120 W/cm type	ANUM15021	215 8.465	125 4.921	24 0.945	100 3.937	
		ANUM30021	350 13.780	250 9.843	24 0.945	200 7.874	
		ANUM60021	600 23.622	500 19.685	24 0.945	400 15.748	
UV lamp	80 W/cm type	ANUM30061	280 11.024	180 7.087	24 0.945	150 5.906	Depends on the irradiation unit
		ANUM60061	475 18.701	375 14.764	24 0.945	300 11.811	
		ANUPL10081	215 8.465	125 4.921	24 0.945	100 3.937	
	120 W/cm type	ANUPL20081	350 13.780	250 9.843	24 0.945	200 7.874	
		ANUPL30081	475 18.701	375 14.764	24 0.945	300 11.811	
		ANUPL60081	850 33.465	750 29.528	24 0.945	650 25.591	
160 W/cm type	ANUPL15021	215 8.465	125 4.921	24 0.945	100 3.937		
	ANUPL30021	350 13.780	250 9.843	24 0.945	200 7.874		
	ANUPL60021	600 23.622	500 19.685	24 0.945	400 15.748		
160 W/cm type	ANUPL30061	280 11.024	180 7.087	24 0.945	150 5.906	Depends on the irradiation unit	
	ANUPL60061	475 18.701	375 14.764	24 0.945	300 11.811		
	ANUPL60061	475 18.701	375 14.764	24 0.945	300 11.811		

Note: The effective irradiation width refers to the irradiation width when the light intensity is approx. 75 % of the peak intensity. The standard effective irradiation width along the lamp width is 50 mm 1.969 in. Areas outside the effective irradiation width are also irradiated with UV rays; however, the irradiation intensity in such areas is lower, taking longer to complete the curing process.

Precautions for lamp handling

- The arc tube is heated (+700 to +800 °C +1,292 to +1,472 °F) during the lamp lighting. If the arc tube makes contact with a foreign substance or the user's bare hands, the dirt can cause the tube to lose its clarity, decreasing the lamp efficiency. When setting up the lamp, wipe the lamp with alcohol.
- Lighting the lamp alone will overheat and shorten the lamp life. Make sure to use a UV irradiation unit designed by our company and cool the lamp.