



Chipsmall Limited consists of a professional team with an average of over 10 year of expertise in the distribution of electronic components. Based in Hongkong, we have already established firm and mutual-benefit business relationships with customers from,Europe,America and south Asia,supplying obsolete and hard-to-find components to meet their specific needs.

With the principle of “Quality Parts,Customers Priority,Honest Operation,and Considerate Service”,our business mainly focus on the distribution of electronic components. Line cards we deal with include Microchip,ALPS,ROHM,Xilinx,Pulse,ON,Everlight and Freescale. Main products comprise IC,Modules,Potentiometer,IC Socket,Relay,Connector.Our parts cover such applications as commercial,industrial, and automotives areas.

We are looking forward to setting up business relationship with you and hope to provide you with the best service and solution. Let us make a better world for our industry!



## Contact us

Tel: +86-755-8981 8866 Fax: +86-755-8427 6832

Email & Skype: info@chipsmall.com Web: www.chipsmall.com

Address: A1208, Overseas Decoration Building, #122 Zhenhua RD., Futian, Shenzhen, China



# 1A LOW NOISE CMOS LDO REGULATOR WITH ENABLE AP2114

## General Description

The AP2114 is CMOS process low dropout linear regulator with enable function, the regulator delivers a guaranteed 1A (Min) continuous load current.

The AP2114 features low power consumption.

The AP2114 is available in 1.2V, 1.5V, 1.8V, 2.5V and 3.3V regulator output and 0.8V to 5V adjustable output, and available in excellent output accuracy  $\pm 1.5\%$ , it is also available in an excellent load regulation and line regulation performance.

The AP2114 is available in standard packages of SOT-223, TO-252-2(1), TO-252-2(3), TO-252-2(4), TO-263-3, SOIC-8 and PSOP-8.

## Features

- Output Voltage Accuracy:  $\pm 1.5\%$
- Output Current: 1A (Min)
- Fold-back Short Current Protection: 50mA
- Low Dropout Voltage (3.3V): 450mV (Typ) @  $I_{OUT}=1A$
- Stable with 4.7 $\mu$ F Flexible Cap: Ceramic, Tantalum and Aluminum Electrolytic
- Excellent Line Regulation: 0.02%/V (Typ), 0.1%/V (Max) @  $I_{OUT}=30mA$
- Excellent Load Regulation: 0.2%A (Typ) @  $I_{OUT}=1mA$  to 1A
- Low Quiescent Current: 60 $\mu$ A (1.2V/1.5V/1.8V /2.5V/ADJ)
- Low Output Noise: 30 $\mu$ V<sub>RMS</sub>
- PSRR: 68dB @ Freq=1KHz(1.2V/1.5V/1.8V /ADJ)
- OTSD Protection
- Operating Temperature Range: -40°C to 85°C
- ESD: MM 400V, HBM 4000V

## Applications

- LCD Monitor
- LCD TV
- STB

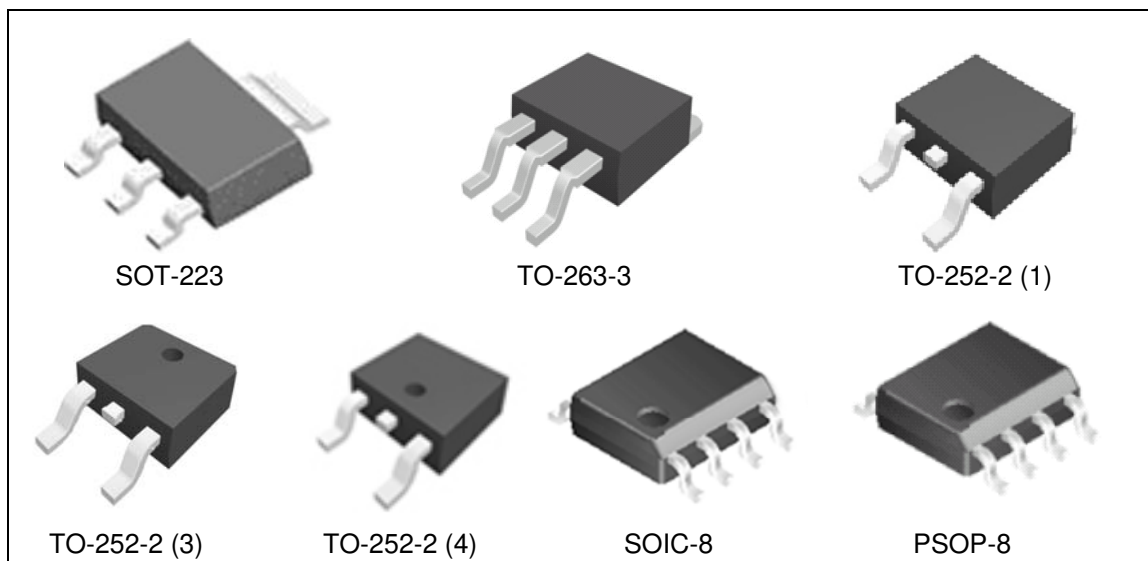

Figure 1. Package Types of AP2114

**1A LOW NOISE CMOS LDO REGULATOR WITH ENABLE AP2114**

**Pin Configuration**

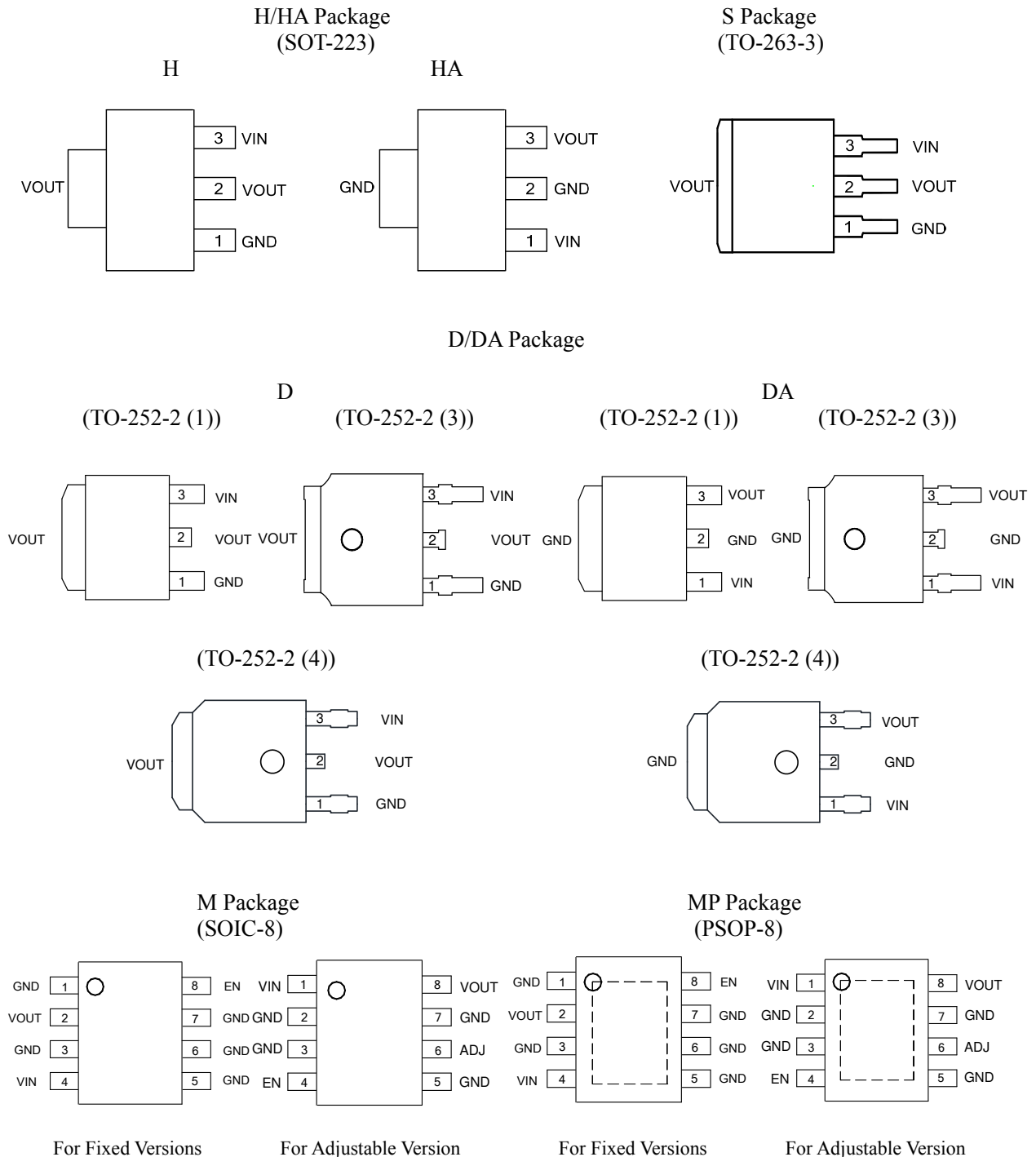

Figure 2. Pin Configuration of AP2114 (Top View)

# 1A LOW NOISE CMOS LDO REGULATOR WITH ENABLE AP2114

## Pin Descriptions

| Pin Number  |   |                        |                      | Pin Name | Function                                       |
|---|---|------------------------|----------------------|----------|--|
| SOT-223 (H), TO-263-3, TO-252-2 (1) (D) TO-252-2 (3) (D) TO-252-2 (4) (D) | SOT-223 (HA), TO-252-2 (1) (DA) TO-252-2 (3) (DA) TO-252-2 (4) (DA) | SOIC-8, PSOP-8 (Fixed) | SOIC-8, PSOP-8 (ADJ) |          |  |
| 1   | 2   | 1, 3, 5, 6, 7          | 2, 3, 5, 7           | GND      | Ground   |
| 2   | 3   | 2                      | 8                    | VOUT     | Regulated Output                               |
| 3   | 1   | 4                      | 1                    | VIN      | Input Voltage Pin                              |
|   |   | 8                      | 4                    | EN       | Chip Enable, H-Normal Work, L- Shutdown Output |
|   |   |                        | 6                    | ADJ      | Adjust Output                                  |

## Functional Block Diagram

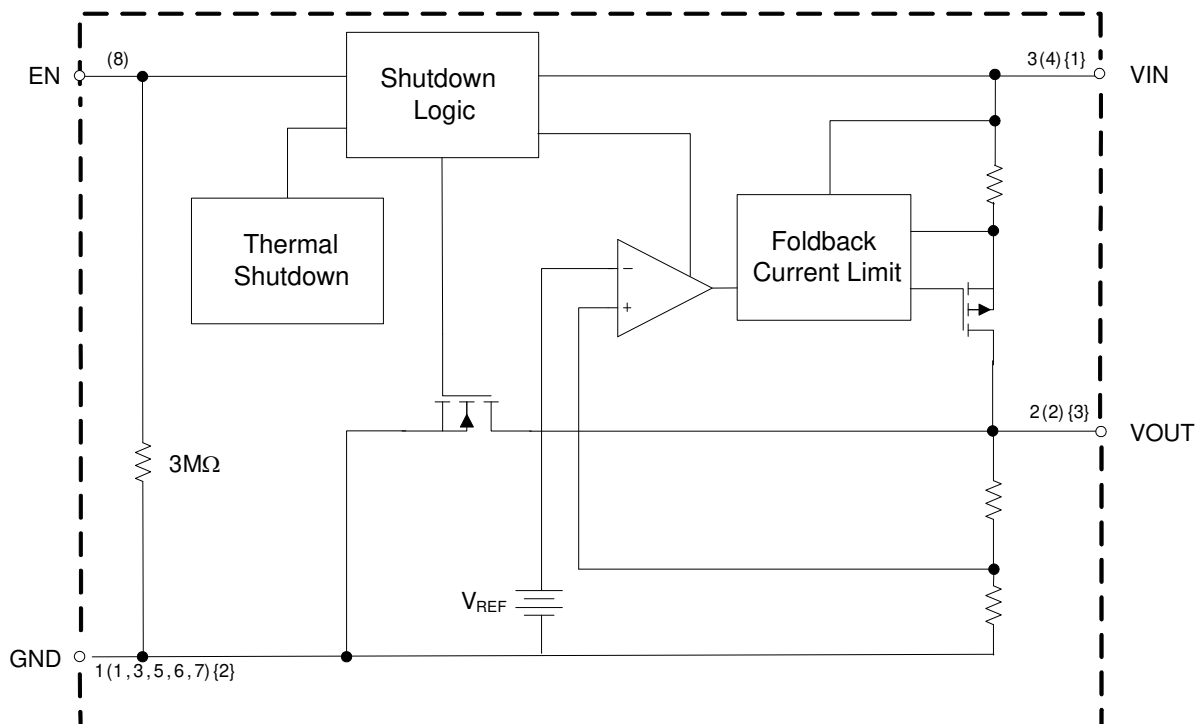

A(B){C}  
 A: SOT-223(H), TO-263-3, TO-252-2(1)/(3)/(4)(D)  
 B: SOIC-8, PSOP-8  
 C: SOT-223 (HA), TO-252-2(1)/(3)/(4)(DA)

For Fixed Versions

**1A LOW NOISE CMOS LDO REGULATOR WITH ENABLE AP2114**

**Functional Block Diagram (Continued)**

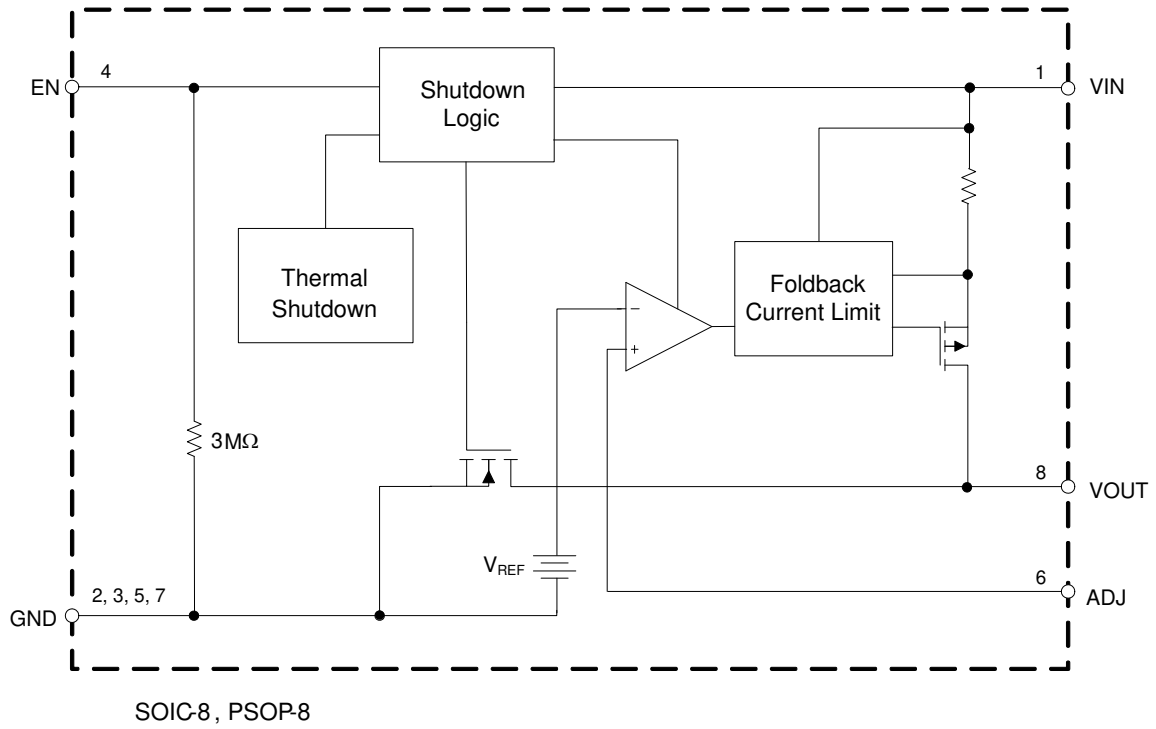

For ADJ Version

Figure 3. Functional Block Diagram of AP2114

**1A LOW NOISE CMOS LDO REGULATOR WITH ENABLE AP2114**

**Ordering Information**

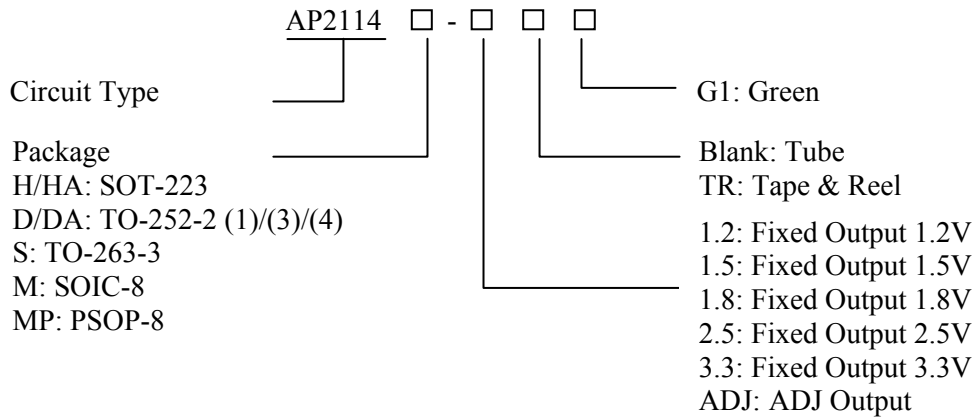

| Package  | Temperature Range | Output Voltage  | Part Number      | Marking ID     | Packing Type |
|--|-------------------|-----------------|------------------|----------------|--------------|
| SOT-223  | -40 to 85°C       | 1.2V (H)        | AP2114H-1.2TRG1  | GH12C          | Tape & Reel  |
|  |                   | 1.5V (H)        | AP2114H-1.5TRG1  | GH16G          | Tape & Reel  |
|  |                   | 1.8V (H)        | AP2114H-1.8TRG1  | GH12D          | Tape & Reel  |
|  |                   | 2.5V (H)        | AP2114H-2.5TRG1  | GH14C          | Tape & Reel  |
|  |                   | 3.3V (H)        | AP2114H-3.3TRG1  | GH12E          | Tape & Reel  |
| SOT-223  | -40 to 85°C       | 1.2V (HA)       | AP2114HA-1.2TRG1 | GH13B          | Tape & Reel  |
|  |                   | 1.5V (HA)       | AP2114HA-1.5TRG1 | GH16H          | Tape & Reel  |
|  |                   | 1.8V (HA)       | AP2114HA-1.8TRG1 | GH14D          | Tape & Reel  |
|  |                   | 2.5V (HA)       | AP2114HA-2.5TRG1 | GH14E          | Tape & Reel  |
|  |                   | 3.3V (HA)       | AP2114HA-3.3TRG1 | GH14F          | Tape & Reel  |
| TO-252-2 (1)/<br>TO-252-2 (3)/<br>TO-252-2 (4) | -40 to 85°C       | 1.2V (D)        | AP2114D-1.2TRG1  | AP2114D-1.2G1  | Tape & Reel  |
|  |                   | 1.5V (D)        | AP2114D-1.5TRG1  | AP2114D-1.5G1  | Tape & Reel  |
|  |                   | 1.8V (D)        | AP2114D-1.8TRG1  | AP2114D-1.8G1  | Tape & Reel  |
|  |                   | 2.5V (D)        | AP2114D-2.5TRG1  | AP2114D-2.5G1  | Tape & Reel  |
|  |                   | 3.3V (D)        | AP2114D-3.3TRG1  | AP2114D-3.3G1  | Tape & Reel  |
| TO-252-2 (1)/<br>TO-252-2 (3)/<br>TO-252-2 (4) | -40 to 85°C       | 1.2V (DA)       | AP2114DA-1.2TRG1 | AP2114DA-1.2G1 | Tape & Reel  |
|  |                   | 1.5V (DA)       | AP2114DA-1.5TRG1 | AP2114DA-1.5G1 | Tape & Reel  |
|  |                   | 1.8V (DA)       | AP2114DA-1.8TRG1 | AP2114DA-1.8G1 | Tape & Reel  |
|  |                   | 2.5V (DA)       | AP2114DA-2.5TRG1 | AP2114DA-2.5G1 | Tape & Reel  |
|  |                   | 3.3V (DA)       | AP2114DA-3.3TRG1 | AP2114DA-3.3G1 | Tape & Reel  |
| TO-263-3                                       | -40 to 85°C       | 1.2V            | AP2114S-1.2TRG1  | AP2114S-1.2G1  | Tape & Reel  |
|  |                   | 1.5V            | AP2114S-1.5TRG1  | AP2114S-1.5G1  | Tape & Reel  |
|  |                   | 1.8V            | AP2114S-1.8TRG1  | AP2114S-1.8G1  | Tape & Reel  |
|  |                   | 2.5V            | AP2114S-2.5TRG1  | AP2114S-2.5G1  | Tape & Reel  |
|  |                   | 3.3V            | AP2114S-3.3TRG1  | AP2114S-3.3G1  | Tape & Reel  |
| SOIC-8   | -40 to 85°C       | 1.2V            | AP2114M-1.2TRG1  | 2114M-1.2G1    | Tape & Reel  |
|  |                   | 1.5V            | AP2114M-1.5TRG1  | 2114M-1.5G1    | Tape & Reel  |
|  |                   | 1.8V            | AP2114M-1.8TRG1  | 2114M-1.8G1    | Tape & Reel  |
|  |                   | 2.5V            | AP2114M-2.5TRG1  | 2114M-2.5G1    | Tape & Reel  |
|  |                   | 3.3V            | AP2114M-3.3TRG1  | 2114M-3.3G1    | Tape & Reel  |
|  |                   | ADJ             | AP2114M-ADJG1    | 2114M-ADJG1    | Tube         |
|  |                   | AP2114M-ADJTRG1 | 2114M-ADJG1      | Tape & Reel    |              |

**1A LOW NOISE CMOS LDO REGULATOR WITH ENABLE AP2114****Ordering Information (Continued)**

| Package | Temperature Range | Output Voltage | Part Number      | Marking ID   | Packing Type |
|---------|-------------------|----------------|------------------|--------------|--------------|
| PSOP-8  | -40 to 85°C       | 1.2V           | AP2114MP-1.2TRG1 | 2114MP-1.2G1 | Tape & Reel  |
|         |                   | 1.5V           | AP2114MP-1.5TRG1 | 2114MP-1.5G1 | Tape & Reel  |
|         |                   | 1.8V           | AP2114MP-1.8TRG1 | 2114MP-1.8G1 | Tape & Reel  |
|         |                   | 2.5V           | AP2114MP-2.5TRG1 | 2114MP-2.5G1 | Tape & Reel  |
|         |                   | 3.3V           | AP2114MP-3.3TRG1 | 2114MP-3.3G1 | Tape & Reel  |
|         |                   | ADJ            | AP2114MP-ADJG1   | 2114MP-ADJG1 | Tube         |
|         |                   |                | AP2114MP-ADJTRG1 | 2114MP-ADJG1 | Tape & Reel  |

BCD Semiconductor's Pb-free products, as designated with "G1" suffix in the part number, are RoHS compliant and Green.

**1A LOW NOISE CMOS LDO REGULATOR WITH ENABLE AP2114****Absolute Maximum Ratings (Note 1)**

| Parameter  | Symbol        | Value  |     | Unit |
|--|---------------|--|-----|------|
| Power Supply Voltage                                   | $V_{IN}$      | 6.5  |     | V    |
| Operating Junction Temperature Range                   | $T_J$         | 150  |     | °C   |
| Storage Temperature Range                              | $T_{STG}$     | -65 to 150                                     |     | °C   |
| Lead Temperature (Soldering, 10sec)                    | $T_{LEAD}$    | 260  |     | °C   |
| Thermal Resistance (Junction to Ambient) (No Heatsink) | $\theta_{JA}$ | SOIC-8   | 144 | °C/W |
|  |               | PSOP-8   | 143 |      |
|  |               | SOT-223  | 128 |      |
|  |               | TO-252-2 (1)/<br>TO-252-2 (3)/<br>TO-252-2 (4) | 90  |      |
|  |               | TO-263-3                                       | 73  |      |
| ESD (Machine Model)                                    |               | 400  |     | V    |
| ESD (Human Body Model)                                 |               | 4000   |     | V    |

Note 1: Stresses greater than those listed under “Absolute Maximum Ratings” may cause permanent damage to the device. These are stress ratings only, and functional operation of the device at these or any other conditions beyond those indicated under “Recommended Operating Conditions” is not implied. Exposure to “Absolute Maximum Ratings” for extended periods may affect device reliability.

**Recommended Operating Conditions**

| Parameter                           | Symbol   | Min | Max | Unit |
|-------------------------------------|----------|-----|-----|------|
| Supply Voltage                      | $V_{IN}$ | 2.5 | 6.0 | V    |
| Operating Ambient Temperature Range | $T_A$    | -40 | 85  | °C   |





**1A LOW NOISE CMOS LDO REGULATOR WITH ENABLE AP2114**

**Electrical Characteristics**

**AP2114-1.2 Electrical Characteristics (Note 2)**

( $V_{IN}=2.5V$ ,  $C_{IN}=4.7\mu F$  (Ceramic),  $C_{OUT}=4.7\mu F$  (Ceramic), Typical  $T_A=25^\circ C$ , **Bold** typeface applies over  $-40^\circ C \leq T_A \leq 85^\circ C$  ranges, unless otherwise specified (Note 3))

| Parameter                              | Symbol  | Test Conditions                                      | Min                             | Typ                        | Max                              | Unit            |
|--|---|--|---------------------------------|----------------------------|----------------------------------|-----------------|
| Output Voltage                         | $V_{OUT}$                                       | $V_{IN}=2.5V$ , $1mA \leq I_{OUT} \leq 30mA$         | $\frac{V_{OUT}}{\times 98.5\%}$ | 1.2                        | $\frac{V_{OUT}}{\times 101.5\%}$ | V               |
| Input Voltage                          | $V_{IN}$  |  |                                 |                            | 6.0                              | V               |
| Maximum Output Current                 | $I_{OUT(MAX)}$                                  | $V_{IN}=2.5V$ , $V_{OUT}=1.182V$ to $1.218V$         | 1                               |                            |                                  | A               |
| Load Regulation                        | $\frac{\Delta V_{OUT}/V_{OUT}}{\Delta I_{OUT}}$ | $V_{IN}=2.5V$ , $1mA \leq I_{OUT} \leq 1A$           |                                 | 0.2                        | 1                                | %/A             |
| Line Regulation                        | $\frac{\Delta V_{OUT}/V_{OUT}}{\Delta V_{IN}}$  | $2.5V \leq V_{IN} \leq 6V$ , $I_{OUT}=30mA$          | -0.1                            | 0.02                       | 0.1                              | %/V             |
| Dropout Voltage                        | $V_{DROP}$                                      | $I_{OUT}=1.0A$                                       |                                 | 1200                       | 1300                             | mV              |
| Quiescent Current                      | $I_Q$   | $V_{IN}=2.5V$ , $I_{OUT}=0mA$                        |                                 | 60                         | 75                               | $\mu A$         |
| Power Supply Rejection Ratio           | PSRR  | Ripple 1Vp-p<br>$V_{IN}=2.5V$ ,<br>$I_{OUT}=100mA$   | $f=100Hz$                       | 68                         |                                  | dB              |
|  |   |  | $f=1KHz$                        | 68                         |                                  |                 |
| Output Voltage Temperature Coefficient | $\frac{\Delta V_{OUT}/V_{OUT}}{\Delta T}$       | $I_{OUT}=30mA$ , $T_A = -40^\circ C$ to $85^\circ C$ |                                 | <b><math>\pm 30</math></b> |                                  | ppm/ $^\circ C$ |
| Short Current Limit                    | $I_{SHORT}$                                     | $V_{OUT}=0V$   |                                 | 50                         |                                  | mA              |
| RMS Output Noise                       | $V_{NOISE}$                                     | $10Hz \leq f \leq 100kHz$ (No Load)                  |                                 | 30                         |                                  | $\mu V_{RMS}$   |
| $V_{EN}$ High Voltage                  | $V_{IH}$  | Enable logic high, regulator on                      | 1.5                             |                            |                                  | V               |
| $V_{EN}$ Low Voltage                   | $V_{IL}$  | Enable logic low, regulator off                      |                                 |                            | 0.4                              |                 |
| Standby Current                        | $I_{STD}$                                       | $V_{IN}=2.5V$ , $V_{EN}$ in OFF mode                 |                                 | 0.01                       | 1.0                              | $\mu A$         |
| Start-up Time                          | $t_s$   | No Load  |                                 | 20                         |                                  | $\mu s$         |
| EN Pull Down Resistor                  | $R_{PD}$  |  |                                 | 3.0                        |                                  | M $\Omega$      |
| $V_{OUT}$ Discharge Resistor           | $R_{DCHG}$                                      | Set EN pin at Low                                    |                                 | 60                         |                                  | $\Omega$        |
| Thermal Shutdown Temperature           | $T_{OTSD}$                                      |  |                                 | 160                        |                                  | $^\circ C$      |
| Thermal Shutdown Hysteresis            | $T_{HYOTSD}$                                    |  |                                 | 25                         |                                  |                 |
| Thermal Resistance (Junction to Case)  | $\theta_{JC}$                                   | SOIC-8   |                                 | 74.6                       |                                  | $^\circ C/W$    |
|  |   | PSOP-8   |                                 | 43.7                       |                                  |                 |
|  |   | SOT-223  |                                 | 50.9                       |                                  |                 |
|  |   | TO-252-2 (1)/(3)/(4)                                 |                                 | 35                         |                                  |                 |
|  |   | TO-263-3   |                                 | 22                         |                                  |                 |

Note 2: To prevent the Short Circuit Current protection feature from being prematurely activated, the input voltage must be applied before a current source load is applied.

Note 3: Production testing at  $T_A=25^\circ C$ . Over temperature specifications guaranteed by design only.



**1A LOW NOISE CMOS LDO REGULATOR WITH ENABLE AP2114**

**Electrical Characteristics (Continued)**

**AP2114-1.5 Electrical Characteristics (Note 2)**

( $V_{IN}=2.5V$ ,  $C_{IN}=4.7\mu F$  (Ceramic),  $C_{OUT}=4.7\mu F$  (Ceramic), Typical  $T_A=25^\circ C$ , **Bold** typeface applies over  $-40^\circ C \leq T_A \leq 85^\circ C$  ranges, unless otherwise specified (Note 3))

| Parameter                              | Symbol  | Test Conditions                                      | Min                             | Typ                        | Max                              | Unit            |
|--|---|--|---------------------------------|----------------------------|----------------------------------|-----------------|
| Output Voltage                         | $V_{OUT}$                                       | $V_{IN}=2.5V$ , $1mA \leq I_{OUT} \leq 30mA$         | $\frac{V_{OUT}}{\times 98.5\%}$ | 1.5                        | $\frac{V_{OUT}}{\times 101.5\%}$ | V               |
| Input Voltage                          | $V_{IN}$  |  |                                 |                            | 6.0                              | V               |
| Maximum Output Current                 | $I_{OUT(MAX)}$                                  | $V_{IN}=2.5V$ , $V_{OUT}=1.478V$ to $1.523V$         | 1                               |                            |                                  | A               |
| Load Regulation                        | $\frac{\Delta V_{OUT}/V_{OUT}}{\Delta I_{OUT}}$ | $V_{IN}=2.5V$ , $1mA \leq I_{OUT} \leq 1A$           |                                 | 0.2                        | 1                                | %/A             |
| Line Regulation                        | $\frac{\Delta V_{OUT}/V_{OUT}}{\Delta V_{IN}}$  | $2.5V \leq V_{IN} \leq 6V$ , $I_{OUT}=30mA$          | -0.1                            | 0.02                       | 0.1                              | %/V             |
| Dropout Voltage                        | $V_{DROP}$                                      | $I_{OUT}=1.0A$                                       |                                 | 800                        | 1000                             | mV              |
| Quiescent Current                      | $I_Q$   | $V_{IN}=2.5V$ , $I_{OUT}=0mA$                        |                                 | 60                         | 75                               | $\mu A$         |
| Power Supply Rejection Ratio           | PSRR  | Ripple 1Vp-p<br>$V_{IN}=2.5V$ ,<br>$I_{OUT}=100mA$   | $f=100Hz$                       | 68                         |                                  | dB              |
|  |   |  | $f=1KHz$                        | 68                         |                                  |                 |
| Output Voltage Temperature Coefficient | $\frac{\Delta V_{OUT}/V_{OUT}}{\Delta T}$       | $I_{OUT}=30mA$ , $T_A = -40^\circ C$ to $85^\circ C$ |                                 | <b><math>\pm 30</math></b> |                                  | ppm/ $^\circ C$ |
| Short Current Limit                    | $I_{SHORT}$                                     | $V_{OUT}=0V$   |                                 | 50                         |                                  | mA              |
| RMS Output Noise                       | $V_{NOISE}$                                     | $10Hz \leq f \leq 100kHz$ (No Load)                  |                                 | 30                         |                                  | $\mu V_{RMS}$   |
| $V_{EN}$ High Voltage                  | $V_{IH}$  | Enable logic high, regulator on                      | 1.5                             |                            |                                  | V               |
| $V_{EN}$ Low Voltage                   | $V_{IL}$  | Enable logic low, regulator off                      |                                 |                            | 0.4                              |                 |
| Standby Current                        | $I_{STD}$                                       | $V_{IN}=2.5V$ , $V_{EN}$ in OFF mode                 |                                 | 0.01                       | 1.0                              | $\mu A$         |
| Start-up Time                          | $t_s$   | No Load  |                                 | 20                         |                                  | $\mu s$         |
| EN Pull Down Resistor                  | $R_{PD}$  |  |                                 | 3.0                        |                                  | M $\Omega$      |
| $V_{OUT}$ Discharge Resistor           | $R_{DCHG}$                                      | Set EN pin at Low                                    |                                 | 60                         |                                  | $\Omega$        |
| Thermal Shutdown Temperature           | $T_{OTSD}$                                      |  |                                 | 160                        |                                  | $^\circ C$      |
| Thermal Shutdown Hysteresis            | $T_{HYOTSD}$                                    |  |                                 | 25                         |                                  |                 |
| Thermal Resistance (Junction to Case)  | $\theta_{JC}$                                   | SOIC-8   |                                 | 74.6                       |                                  | $^\circ C/W$    |
|  |   | PSOP-8   |                                 | 43.7                       |                                  |                 |
|  |   | SOT-223  |                                 | 50.9                       |                                  |                 |
|  |   | TO-252-2 (1)/(3)/(4)                                 |                                 | 35                         |                                  |                 |
|  |   | TO-263-3   |                                 | 22                         |                                  |                 |

Note 2: To prevent the Short Circuit Current protection feature from being prematurely activated, the input voltage must be applied before a current source load is applied.

Note 3: Production testing at  $T_A=25^\circ C$ . Over temperature specifications guaranteed by design only.



**1A LOW NOISE CMOS LDO REGULATOR WITH ENABLE AP2114**

**Electrical Characteristics (Continued)**

**AP2114-1.8 Electrical Characteristics (Note 2)**

( $V_{IN}=2.8V$ ,  $C_{IN}=4.7\mu F$  (Ceramic),  $C_{OUT}=4.7\mu F$  (Ceramic), Typical  $T_A=25^\circ C$ , **Bold** typeface applies over  $-40^\circ C \leq T_A \leq 85^\circ C$  ranges, unless otherwise specified (Note 3))

| Parameter                              | Symbol  | Test Conditions                                      | Min                     | Typ                        | Max                      | Unit            |
|--|---|--|-------------------------|----------------------------|--------------------------|-----------------|
| Output Voltage                         | $V_{OUT}$                                       | $V_{IN}=2.8V$ , $1mA \leq I_{OUT} \leq 30mA$         | $V_{OUT} \times 98.5\%$ | 1.8                        | $V_{OUT} \times 101.5\%$ | V               |
| Maximum Output Current                 | $I_{OUT(MAX)}$                                  | $V_{IN}=2.8V$ , $V_{OUT}=1.773V$ to $1.827V$         | 1.0                     |                            |                          | A               |
| Load Regulation                        | $\frac{\Delta V_{OUT}/V_{OUT}}{\Delta I_{OUT}}$ | $V_{IN}=2.8V$ , $1mA \leq I_{OUT} \leq 1A$           |                         | 0.2                        | 1.0                      | %/A             |
| Line Regulation                        | $\frac{\Delta V_{OUT}/V_{OUT}}{\Delta V_{IN}}$  | $2.8V \leq V_{IN} \leq 6V$ , $I_{OUT}=30mA$          | -0.1                    | 0.02                       | 0.1                      | %/V             |
| Dropout Voltage                        | $V_{DROP}$                                      | $I_{OUT}=1.0A$                                       |                         | 500                        | 700                      | mV              |
| Quiescent Current                      | $I_Q$   | $V_{IN}=2.8V$ , $I_{OUT}=0mA$                        |                         | 60                         | 75                       | $\mu A$         |
| Power Supply Rejection Ratio           | PSRR  | Ripple 1Vp-p<br>$V_{IN}=2.8V$ ,<br>$I_{OUT}=100mA$   | $f=100Hz$               |                            | 68                       | dB              |
|  |   |  | $f=1KHz$                |                            | 68                       |                 |
| Output Voltage Temperature Coefficient | $\frac{\Delta V_{OUT}/V_{OUT}}{\Delta T}$       | $I_{OUT}=30mA$ , $T_A = -40^\circ C$ to $85^\circ C$ |                         | <b><math>\pm 30</math></b> |                          | ppm/ $^\circ C$ |
| Short Current Limit                    | $I_{SHORT}$                                     | $V_{OUT}=0V$   |                         | 50                         |                          | mA              |
| RMS Output Noise                       | $V_{NOISE}$                                     | $10Hz \leq f \leq 100kHz$ (No load)                  |                         | 30                         |                          | $\mu V_{RMS}$   |
| $V_{EN}$ High Voltage                  | $V_{IH}$  | Enable logic high, regulator on                      | 1.5                     |                            |                          | V               |
| $V_{EN}$ Low Voltage                   | $V_{IL}$  | Enable logic low, regulator off                      |                         |                            | 0.4                      |                 |
| Standby Current                        | $I_{STD}$                                       | $V_{IN}=2.8V$ , $V_{EN}$ in OFF mode                 |                         | 0.01                       | 1.0                      | $\mu A$         |
| Start-up Time                          | $t_S$   | No Load  |                         | 20                         |                          | $\mu s$         |
| EN Pull Down Resistor                  | $R_{PD}$  |  |                         | 3.0                        |                          | M $\Omega$      |
| $V_{OUT}$ Discharge Resistor           | $R_{DCHG}$                                      | Set EN pin at Low                                    |                         | 60                         |                          | $\Omega$        |
| Thermal Shutdown Temperature           | $T_{OTSD}$                                      |  |                         | 160                        |                          | $^\circ C$      |
| Thermal Shutdown Hysteresis            | $T_{HYOTSD}$                                    |  |                         | 25                         |                          |                 |
| Thermal Resistance (Junction to Case)  | $\theta_{JC}$                                   | SOIC-8   |                         | 74.6                       |                          | $^\circ C / W$  |
|  |   | PSOP-8   |                         | 43.7                       |                          |                 |
|  |   | SOT-223  |                         | 50.9                       |                          |                 |
|  |   | TO-252-2 (1)/(3)/(4)                                 |                         | 35                         |                          |                 |
|  |   | TO-263-3   |                         | 22                         |                          |                 |

Note 2: To prevent the Short Circuit Current protection feature from being prematurely activated, the input voltage must be applied before a current source load is applied.

Note 3: Production testing at  $T_A=25^\circ C$ . Over temperature specifications guaranteed by design only.



**1A LOW NOISE CMOS LDO REGULATOR WITH ENABLE AP2114**

**Electrical Characteristics (Continued)**

**AP2114-2.5 Electrical Characteristics (Note 2)**

( $V_{IN}=3.5V$ ,  $C_{IN}=4.7\mu F$  (Ceramic),  $C_{OUT}=4.7\mu F$  (Ceramic), Typical  $T_A=25^\circ C$ , **Bold** typeface applies over  $-40^\circ C \leq T_A \leq 85^\circ C$  ranges, unless otherwise specified (Note 3))

| Parameter                              | Symbol  | Test Conditions  | Min                     | Typ                        | Max                      | Unit            |
|--|---|--|-------------------------|----------------------------|--------------------------|-----------------|
| Output Voltage                         | $V_{OUT}$                                       | $V_{IN}=3.5V$ , $1mA \leq I_{OUT} \leq 30mA$                       | $V_{OUT} \times 98.5\%$ | 2.5                        | $V_{OUT} \times 101.5\%$ | V               |
| Maximum Output Current                 | $I_{OUT(MAX)}$                                  | $V_{IN}=3.5V$ , $V_{OUT}=2.463V$ to $2.537V$                       | 1.0                     |                            |                          | A               |
| Load Regulation                        | $\frac{\Delta V_{OUT}/V_{OUT}}{\Delta I_{OUT}}$ | $V_{out}=2.5V$ , $V_{IN}=V_{out}+1V$<br>$1mA \leq I_{OUT} \leq 1A$ |                         | 0.2                        | 1.0                      | %/A             |
| Line Regulation                        | $\frac{\Delta V_{OUT}/V_{OUT}}{\Delta V_{IN}}$  | $3.5V \leq V_{IN} \leq 6V$ , $I_{OUT}=30mA$                        | -0.1                    | 0.02                       | 0.1                      | %/V             |
| Dropout Voltage                        | $V_{DROP}$                                      | $I_{OUT}=1A$   |                         | 450                        | 750                      | mV              |
| Quiescent Current                      | $I_Q$   | $V_{IN}=3.5V$ , $I_{OUT}=0mA$                                      |                         | 60                         | 80                       | $\mu A$         |
| Power Supply Rejection Ratio           | PSRR  | Ripple 1Vp-p<br>$V_{IN}=3.5V$ ,<br>$I_{OUT}=100mA$                 | $f=100Hz$               | 65                         |                          | dB              |
|  |   |  | $f=1KHz$                | 65                         |                          |                 |
| Output Voltage Temperature Coefficient | $\frac{\Delta V_{OUT}/V_{OUT}}{\Delta T}$       | $I_{OUT}=30mA$   |                         | <b><math>\pm 30</math></b> |                          | ppm/ $^\circ C$ |
| Short Current Limit                    | $I_{SHORT}$                                     | $V_{OUT}=0V$   |                         | 50                         |                          | mA              |
| RMS Output Noise                       | $V_{NOISE}$                                     | $10Hz \leq f \leq 100kHz$  |                         | 30                         |                          | $\mu V_{RMS}$   |
| $V_{EN}$ High Voltage                  | $V_{IH}$  | Enable logic high, regulator on                                    | 1.5                     |                            |                          | V               |
| $V_{EN}$ Low Voltage                   | $V_{IL}$  | Enable logic low, regulator off                                    |                         |                            | 0.4                      |                 |
| Standby Current                        | $I_{STD}$                                       | $V_{IN}=3.5V$ , $V_{EN}$ in OFF mode                               |                         | 0.01                       | 1.0                      | $\mu A$         |
| Start-up Time                          | $t_s$   | No Load  |                         | 20                         |                          | $\mu s$         |
| EN Pull Down Resistor                  | $R_{PD}$  |  |                         | 3.0                        |                          | M $\Omega$      |
| $V_{OUT}$ Discharge Resistor           | $R_{DCHG}$                                      | Set EN pin at Low  |                         | 60                         |                          | $\Omega$        |
| Thermal Shutdown Temperature           | $T_{OTSD}$                                      |  |                         | 160                        |                          | $^\circ C$      |
| Thermal Shutdown Hysteresis            | $T_{HYOTSD}$                                    |  |                         | 25                         |                          |                 |
| Thermal Resistance (Junction to Case)  | $\theta_{JC}$                                   | SOIC-8   |                         | 74.6                       |                          | $^\circ C/W$    |
|  |   | PSOP-8   |                         | 43.7                       |                          |                 |
|  |   | SOT-223  |                         | 50.9                       |                          |                 |
|  |   | TO-252-2 (1)/(3)/(4)   |                         | 35                         |                          |                 |
|  |   | TO-263-3   |                         | 22                         |                          |                 |

Note 2: To prevent the Short Circuit Current protection feature from being prematurely activated, the input voltage must be applied before a current source load is applied.

Note 3: Production testing at  $T_A=25^\circ C$ . Over temperature specifications guaranteed by design only.



**1A LOW NOISE CMOS LDO REGULATOR WITH ENABLE AP2114**

**Electrical Characteristics (Continued)**

**AP2114-3.3 Electrical Characteristics (Note 2)**

(V<sub>IN</sub>=4.3V, C<sub>IN</sub>=4.7μF (Ceramic), C<sub>OUT</sub>=4.7μF (Ceramic), Typical T<sub>A</sub>= 25°C, **Bold** typeface applies over -40°C≤T<sub>A</sub>≤85°C ranges, unless otherwise specified (Note 3))

| Parameter                              | Symbol  | Test Conditions   | Min                     | Typ        | Max                      | Unit              |
|--|---|---|-------------------------|------------|--------------------------|-------------------|
| Output Voltage                         | V <sub>OUT</sub>                                | V <sub>IN</sub> =4.3V, 1mA ≤ I <sub>OUT</sub> ≤ 30mA              | V <sub>OUT</sub> ×98.5% | 3.3        | V <sub>OUT</sub> ×101.5% | V                 |
| Maximum Output Current                 | I <sub>OUT(MAX)</sub>                           | V <sub>IN</sub> =4.3V, V <sub>OUT</sub> =3.25V to 3.35V           | 1.0                     |            |                          | A                 |
| Load Regulation                        | $\frac{\Delta V_{OUT}/V_{OUT}}{\Delta I_{OUT}}$ | V <sub>IN</sub> =4.3V, 1mA ≤ I <sub>OUT</sub> ≤1A                 |                         | 0.2        | 1.0                      | %/A               |
| Line Regulation                        | $\frac{\Delta V_{OUT}/V_{OUT}}{\Delta V_{IN}}$  | 4.3V≤V <sub>IN</sub> ≤6V, I <sub>OUT</sub> =30mA                  | -0.1                    | 0.02       | 0.1                      | %/V               |
| Dropout Voltage                        | V <sub>DROP</sub>                               | I <sub>OUT</sub> =1A  |                         | 450        | 750                      | mV                |
| Quiescent Current                      | I <sub>Q</sub>                                  | V <sub>IN</sub> =4.3V, I <sub>OUT</sub> =0mA                      |                         | 65         | 90                       | μA                |
| Power Supply Rejection Ratio           | PSRR  | Ripple 1Vp-p<br>V <sub>IN</sub> =4.3V,<br>I <sub>OUT</sub> =100mA | f=100Hz                 | 65         |                          | dB                |
|  |   |   | f=1KHz                  | 65         |                          |                   |
| Output Voltage Temperature Coefficient | $\frac{\Delta V_{OUT}/V_{OUT}}{\Delta T}$       | I <sub>OUT</sub> =30mA  |                         | <b>±30</b> |                          | ppm/°C            |
| Short Current Limit                    | I <sub>SHORT</sub>                              | V <sub>OUT</sub> =0V  |                         | 50         |                          | mA                |
| RMS Output Noise                       | V <sub>NOISE</sub>                              | 10Hz ≤ f ≤100kHz (No load)  |                         | 30         |                          | μV <sub>RMS</sub> |
| V <sub>EN</sub> High Voltage           | V <sub>IH</sub>                                 | Enable logic high, regulator on                                   | 1.5                     |            |                          | V                 |
| V <sub>EN</sub> Low Voltage            | V <sub>IL</sub>                                 | Enable logic low, regulator off                                   |                         |            | 0.4                      |                   |
| Standby Current                        | I <sub>STD</sub>                                | V <sub>IN</sub> =4.3V, V <sub>EN</sub> in OFF mode                |                         | 0.01       | 1.0                      | μA                |
| Start-up Time                          | t <sub>s</sub>                                  | No Load   |                         | 20         |                          | μs                |
| EN Pull Down Resistor                  | R <sub>PD</sub>                                 |   |                         | 3.0        |                          | MΩ                |
| V <sub>OUT</sub> Discharge Resistor    | R <sub>DCHG</sub>                               | Set EN pin at Low   |                         | 60         |                          | Ω                 |
| Thermal Shutdown Temperature           | T <sub>OTSD</sub>                               |   |                         | 160        |                          | °C                |
| Thermal Shutdown Hysteresis            | T <sub>HYOTSD</sub>                             |   |                         | 25         |                          |                   |
| Thermal Resistance (Junction to Case)  | θ <sub>JC</sub>                                 | SOIC-8  |                         | 74.6       |                          | °C/W              |
|  |   | PSOP-8  |                         | 43.7       |                          |                   |
|  |   | SOT-223   |                         | 50.9       |                          |                   |
|  |   | TO-252-2 (1)/(3)/(4)  |                         | 35         |                          |                   |
|  |   | TO-263-3  |                         | 22         |                          |                   |

Note 2: To prevent the Short Circuit Current protection feature from being prematurely activated, the input voltage must be applied before a current source load is applied.

Note 3: Production testing at T<sub>A</sub>=25°C. Over temperature specifications guaranteed by design only.



**1A LOW NOISE CMOS LDO REGULATOR WITH ENABLE AP2114**

**Electrical Characteristics (Continued)**

**AP2114-ADJ Electrical Characteristics (Note 2)**

( $V_{IN}=2.5V$ ,  $C_{IN}=4.7\mu F$  (Ceramic),  $C_{OUT}=4.7\mu F$  (Ceramic), Typical  $T_A=25^\circ C$ , **Bold** typeface applies over  $-40^\circ C \leq T_A \leq 85^\circ C$  ranges, unless otherwise specified (Note 3))

| Parameter                              | Symbol  | Test Conditions                                      | Min                             | Typ                        | Max                              | Unit            |
|--|---|--|---------------------------------|----------------------------|----------------------------------|-----------------|
| Reference Voltage                      | $V_{REF}$                                       | $V_{IN}=2.5V$ , $1mA \leq I_{OUT} \leq 30mA$         | $\frac{V_{REF}}{\times 98.5\%}$ | 0.8                        | $\frac{V_{REF}}{\times 101.5\%}$ | V               |
| Input Voltage                          | $V_{IN}$  |  |                                 |                            | 6.0                              | V               |
| Maximum Output Current                 | $I_{OUT(MAX)}$                                  | $V_{IN}=2.5V$ , $V_{OUT}=0.788V$ to $0.812V$         | 1                               |                            |                                  | A               |
| Load Regulation                        | $\frac{\Delta V_{OUT}/V_{OUT}}{\Delta I_{OUT}}$ | $V_{IN}=2.5V$ , $1mA \leq I_{OUT} \leq 1A$           |                                 | 0.2                        | 1                                | %/A             |
| Line Regulation                        | $\frac{\Delta V_{OUT}/V_{OUT}}{\Delta V_{IN}}$  | $2.5V \leq V_{IN} \leq 6V$ , $I_{OUT}=30mA$          | -0.1                            | 0.02                       | 0.1                              | %/V             |
| Quiescent Current                      | $I_Q$   | $V_{IN}=2.5V$ , $I_{OUT}=0mA$                        |                                 | 60                         | 75                               | $\mu A$         |
| Power Supply Rejection Ratio           | PSRR  | Ripple 1Vp-p<br>$V_{IN}=2.5V$ ,<br>$I_{OUT}=100mA$   | $f=100Hz$                       |                            | 68                               | dB              |
|  |   |  | $f=1KHz$                        |                            | 68                               |                 |
| Output Voltage Temperature Coefficient | $\frac{\Delta V_{OUT}/V_{OUT}}{\Delta T}$       | $I_{OUT}=30mA$ , $T_A = -40^\circ C$ to $85^\circ C$ |                                 | <b><math>\pm 30</math></b> |                                  | ppm/ $^\circ C$ |
| Short Current Limit                    | $I_{SHORT}$                                     | $V_{OUT}=0V$   |                                 | 50                         |                                  | mA              |
| RMS Output Noise                       | $V_{NOISE}$                                     | $10Hz \leq f \leq 100kHz$ (No Load)                  |                                 | 30                         |                                  | $\mu V_{RMS}$   |
| $V_{EN}$ High Voltage                  | $V_{IH}$  | Enable logic high, regulator on                      | 1.5                             |                            |                                  | V               |
| $V_{EN}$ Low Voltage                   | $V_{IL}$  | Enable logic low, regulator off                      |                                 |                            | 0.4                              |                 |
| Standby Current                        | $I_{STD}$                                       | $V_{IN}=2.5V$ , $V_{EN}$ in OFF mode                 |                                 | 0.01                       | 1.0                              | $\mu A$         |
| Start-up Time                          | $t_s$   | No Load  |                                 | 20                         |                                  | $\mu s$         |
| EN Pull Down Resistor                  | $R_{PD}$  |  |                                 | 3.0                        |                                  | M $\Omega$      |
| $V_{OUT}$ Discharge Resistor           | $R_{DCHG}$                                      | Set EN pin at Low                                    |                                 | 60                         |                                  | $\Omega$        |
| Thermal Shutdown Temperature           | $T_{OTSD}$                                      |  |                                 | 160                        |                                  | $^\circ C$      |
| Thermal Shutdown Hysteresis            | $T_{HYOTSD}$                                    |  |                                 | 25                         |                                  |                 |
| Thermal Resistance (Junction to Case)  | $\theta_{JC}$                                   | SOIC-8   |                                 | 74.6                       |                                  | $^\circ C/W$    |
|  |   | PSOP-8   |                                 | 43.7                       |                                  |                 |

Note 2: To prevent the Short Circuit Current protection feature from being prematurely activated, the input voltage must be applied before a current source load is applied.

Note 3: Production testing at  $T_A=25^\circ C$ . Over temperature specifications guaranteed by design only.

**1A LOW NOISE CMOS LDO REGULATOR WITH ENABLE AP2114**

**Typical Performance Characteristics**

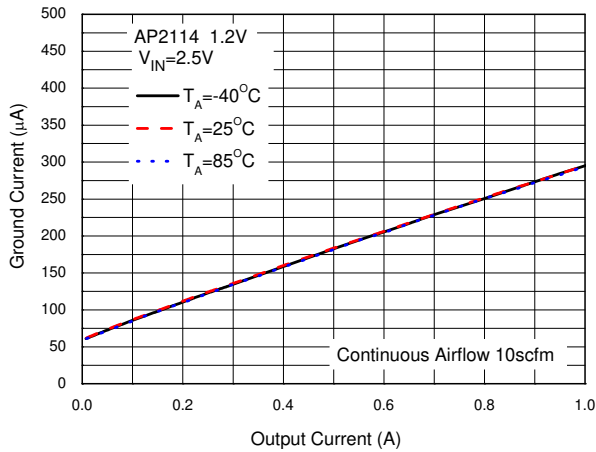

Figure 4. Ground Current vs. Output Current

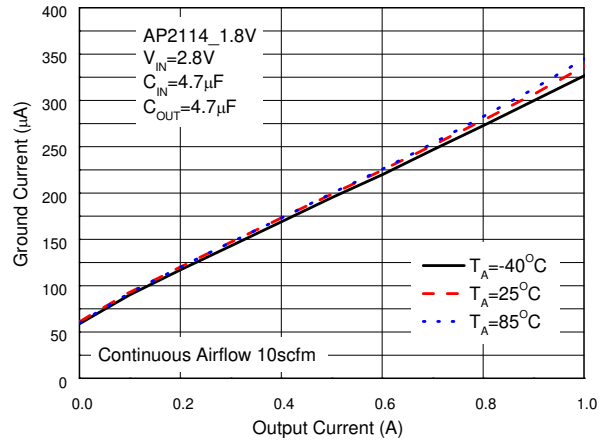

Figure 5. Ground Current vs. Output Current

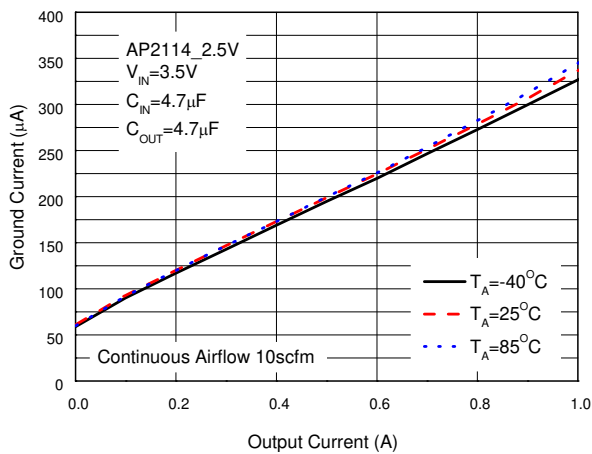

Figure 6. Ground Current vs. Output Current

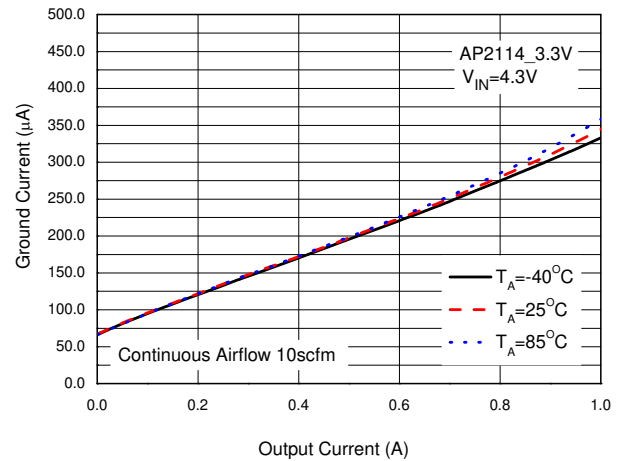

Figure 7. Ground Current vs. Output Current

**1A LOW NOISE CMOS LDO REGULATOR WITH ENABLE AP2114**

**Typical Performance Characteristics (Continued)**

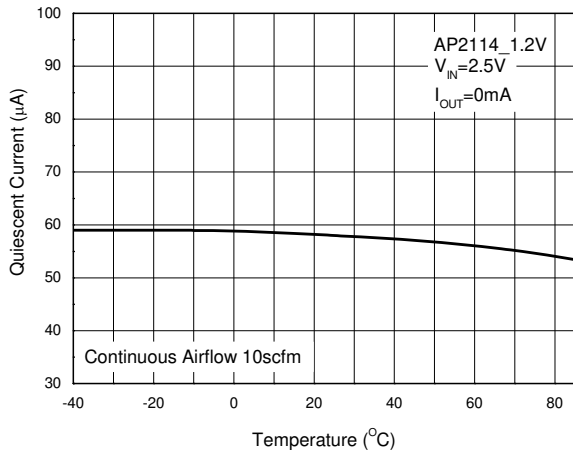

Figure 8. Quiescent Current vs. Temperature

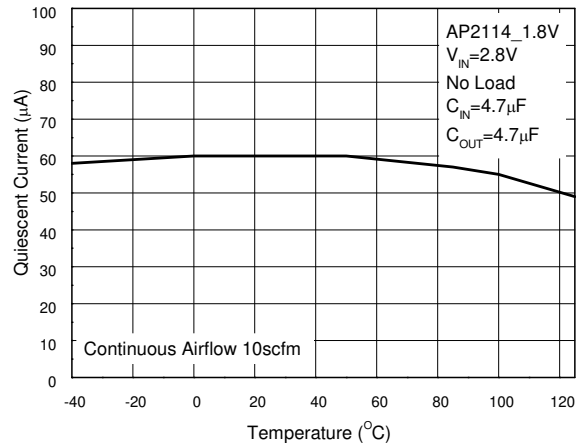

Figure 9. Quiescent Current vs. Temperature

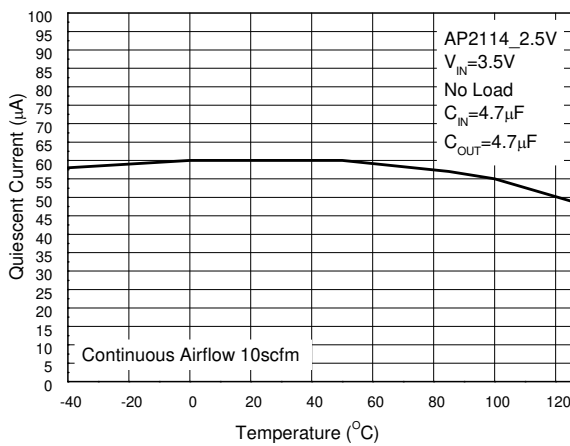

Figure 10. Quiescent Current vs. Temperature

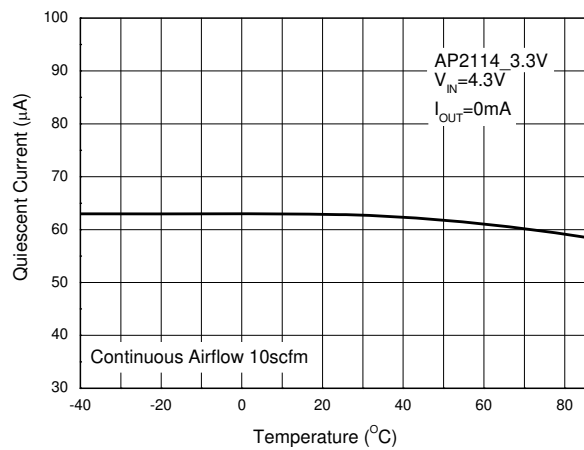

Figure 11. Quiescent Current vs. Temperature



**1A LOW NOISE CMOS LDO REGULATOR WITH ENABLE AP2114**

**Typical Performance Characteristics (Continued)**

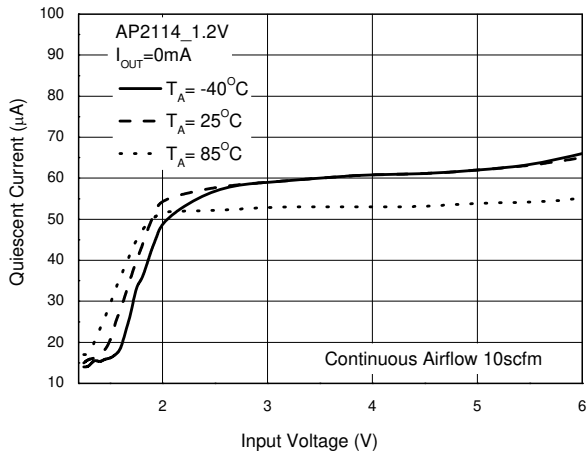

Figure 12. Quiescent Current vs. Input Voltage

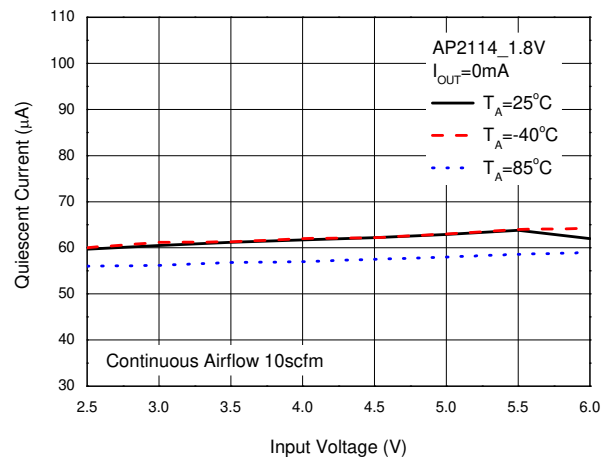

Figure 13. Quiescent Current vs. Input Voltage

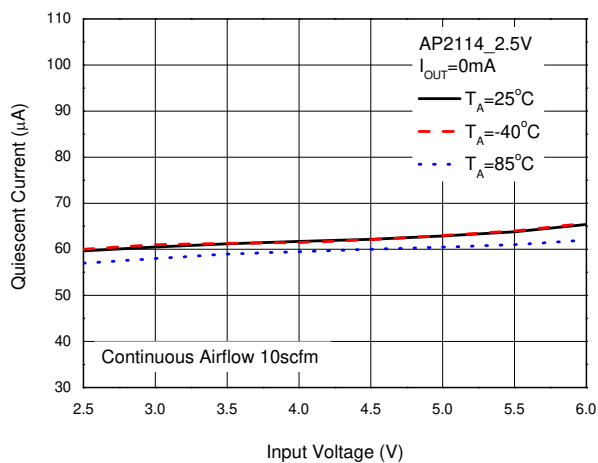

Figure 14. Quiescent Current vs. Input Voltage

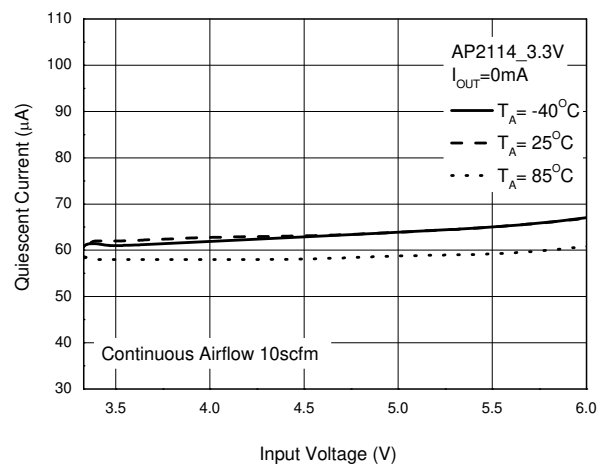

Figure 15. Quiescent Current vs. Input Voltage

**1A LOW NOISE CMOS LDO REGULATOR WITH ENABLE AP2114**

**Typical Performance Characteristics (Continued)**

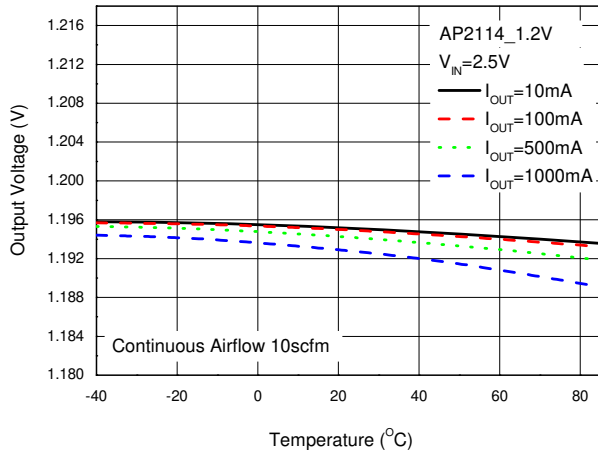

Figure 16. Output Voltage vs. Temperature

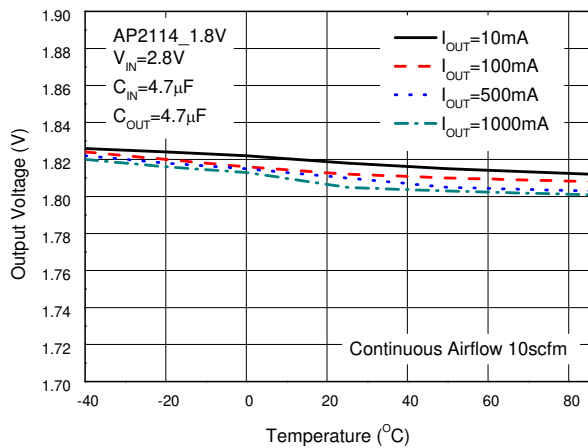

Figure 17. Output Voltage vs. Temperature

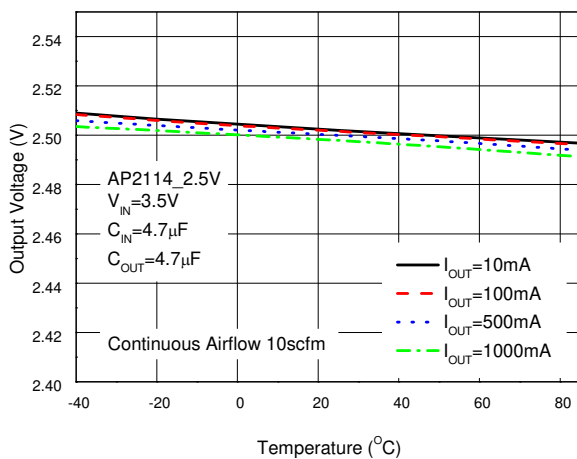

Figure 18. Output Voltage vs. Temperature

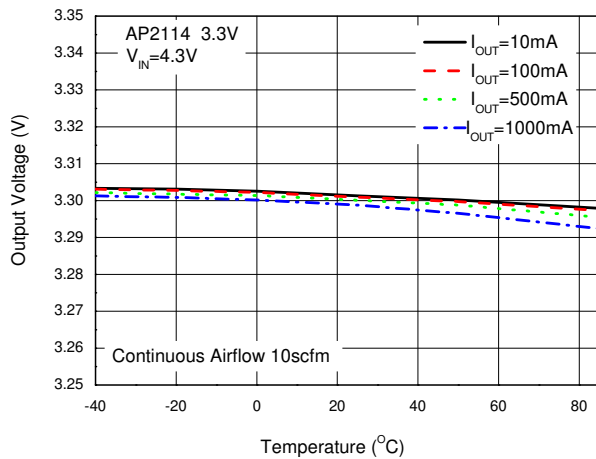

Figure 19. Output Voltage vs. Temperature

**1A LOW NOISE CMOS LDO REGULATOR WITH ENABLE AP2114**

**Typical Performance Characteristics (Continued)**

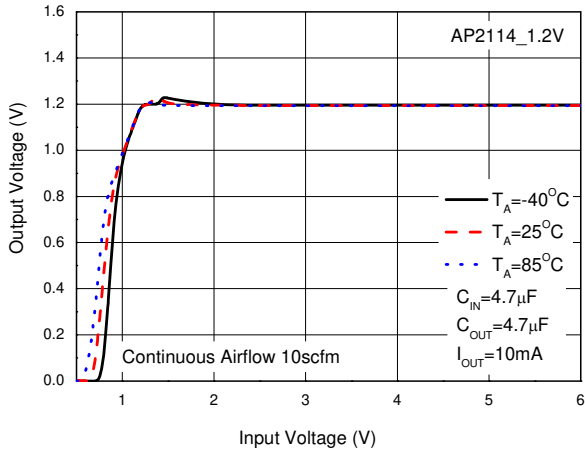

Figure 20. Output Voltage vs. Input Voltage

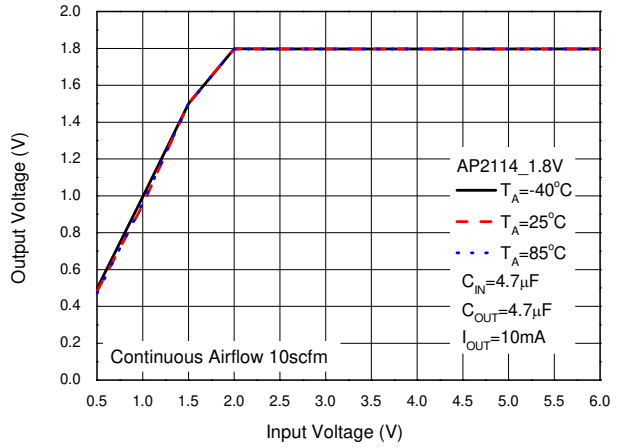

Figure 21. Output Voltage vs. Input Voltage

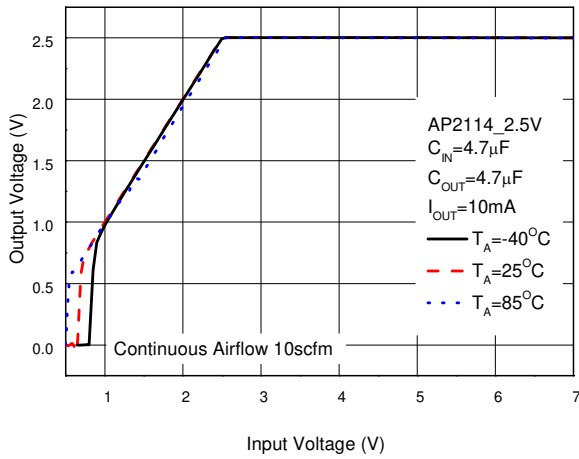

Figure 22. Output Voltage vs. Input Voltage

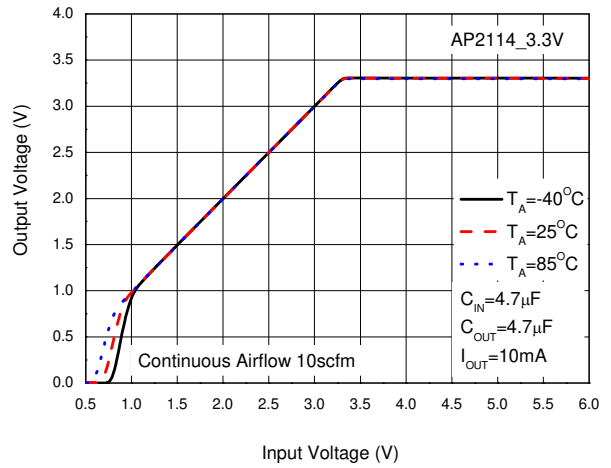

Figure 23. Output Voltage vs. Input Voltage

**1A LOW NOISE CMOS LDO REGULATOR WITH ENABLE AP2114**

**Typical Performance Characteristics (Continued)**

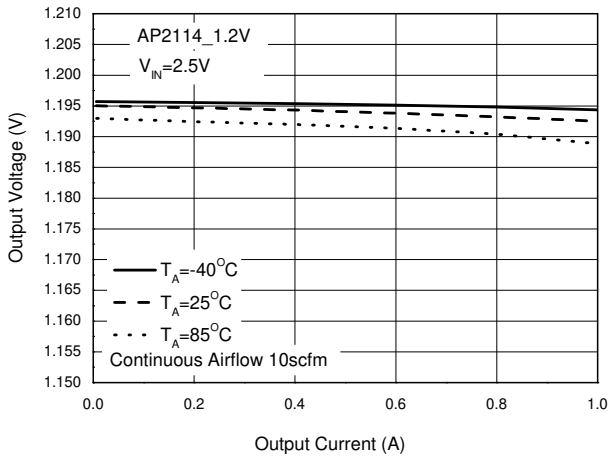

Figure 24. Output Voltage vs. Output Current

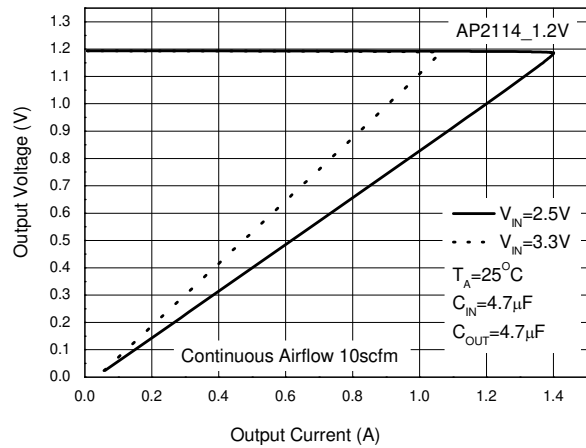

Figure 25. Output Voltage vs. Output Current

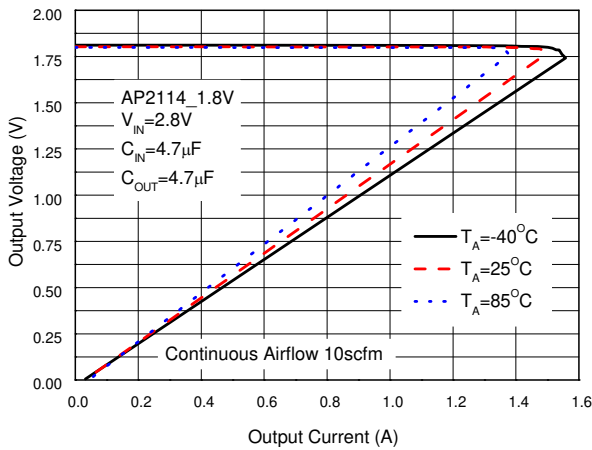

Figure 26. Output Voltage vs. Output Current

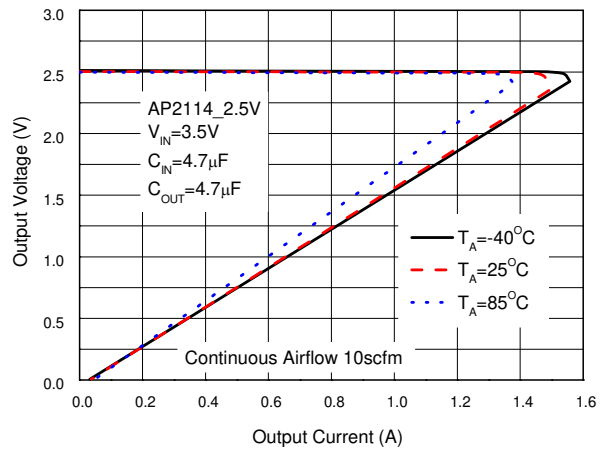

Figure 27. Output Voltage vs. Output Current

**1A LOW NOISE CMOS LDO REGULATOR WITH ENABLE AP2114**

**Typical Performance Characteristics (Continued)**

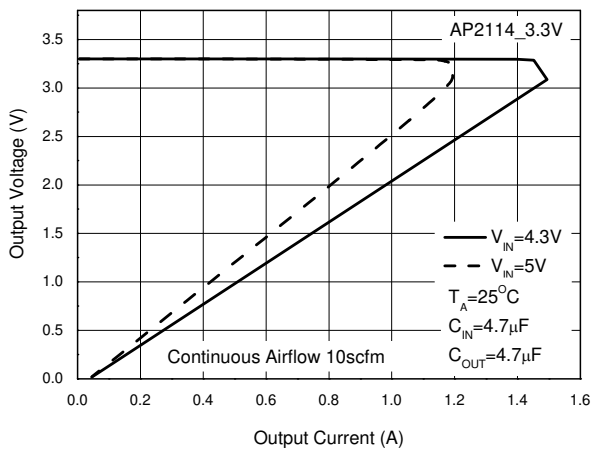

Figure 28. Output Voltage vs. Output Current

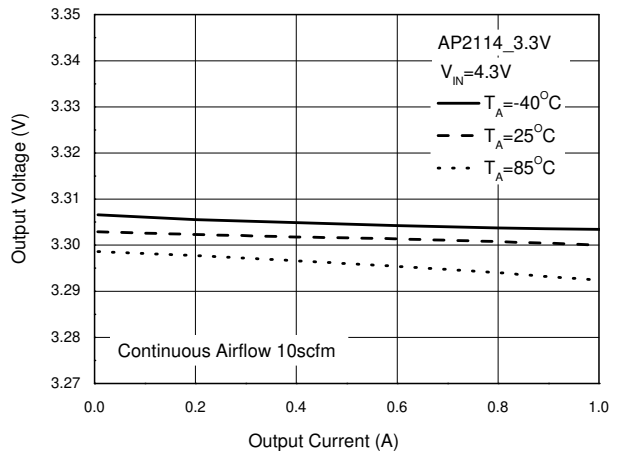

Figure 29. Output Voltage vs. Output Current

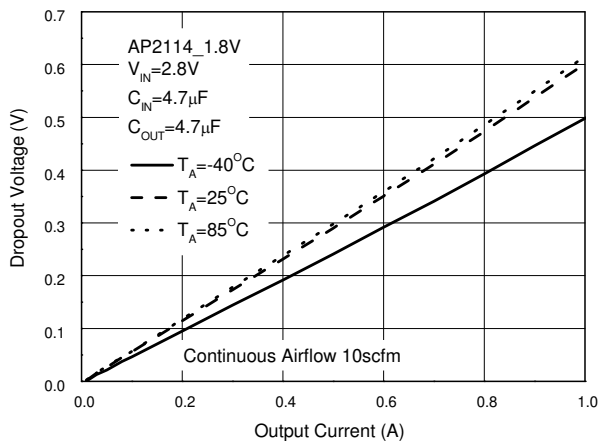

Figure 30. Dropout Voltage vs. Output Current

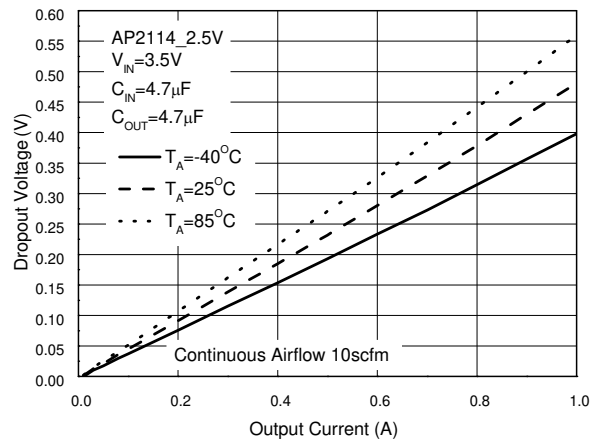

Figure 31. Dropout Voltage vs. Output Current

**1A LOW NOISE CMOS LDO REGULATOR WITH ENABLE AP2114**

**Typical Performance Characteristics (Continued)**

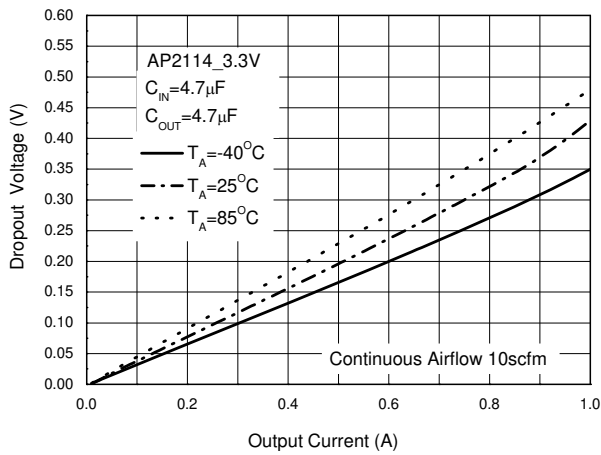

Figure 32. Dropout Voltage vs. Output Current

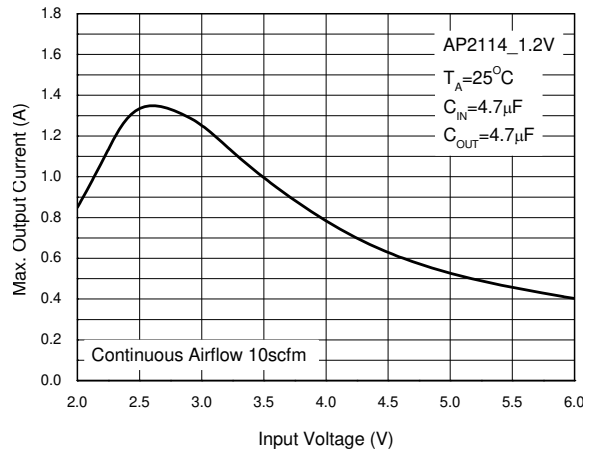

Figure 33. Max. Output Current vs. Input Voltage

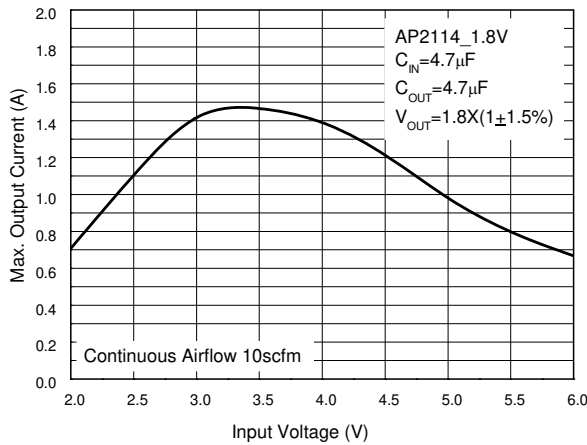

Figure 34. Max. Output Current vs. Input Voltage

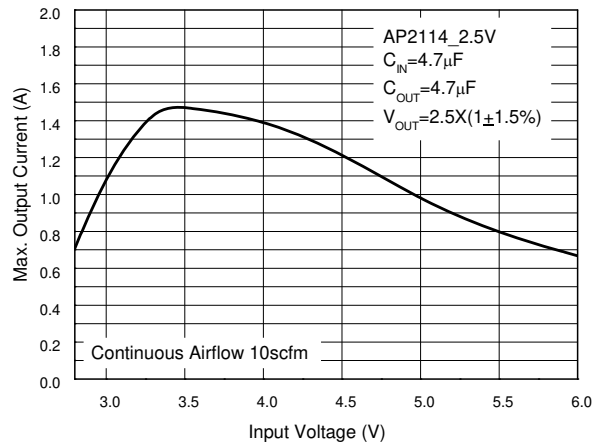

Figure 35. Max. Output Current vs. Input Voltage

**1A LOW NOISE CMOS LDO REGULATOR WITH ENABLE AP2114**

**Typical Performance Characteristics (Continued)**

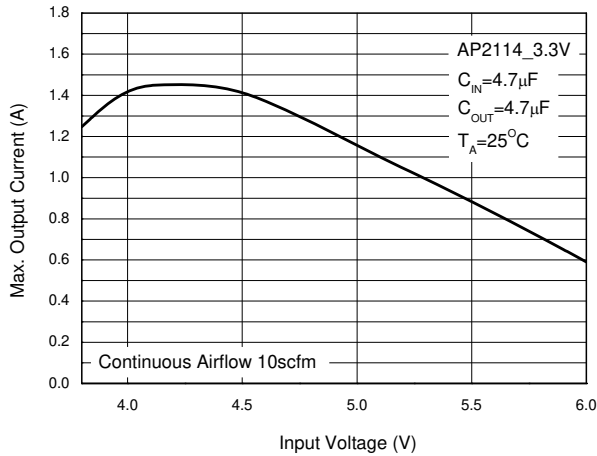

Figure 36. Max. Output Current vs. Input Voltage

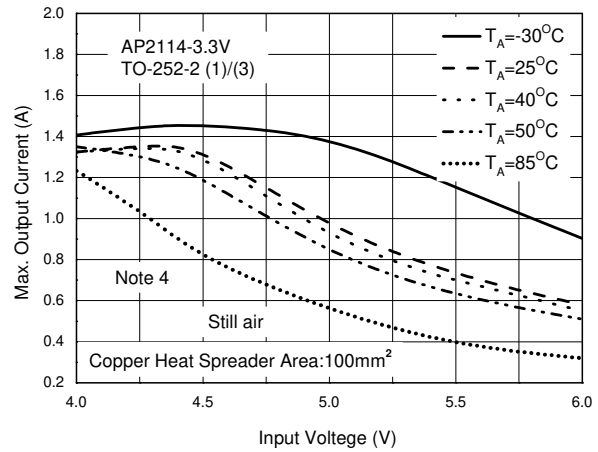

Figure 37. Max. Output Current vs. Input Voltage

Note 4: Considering power dissipation and thermal behavior, we suggest provide enough design margins in application design which are no less than 30% at least.

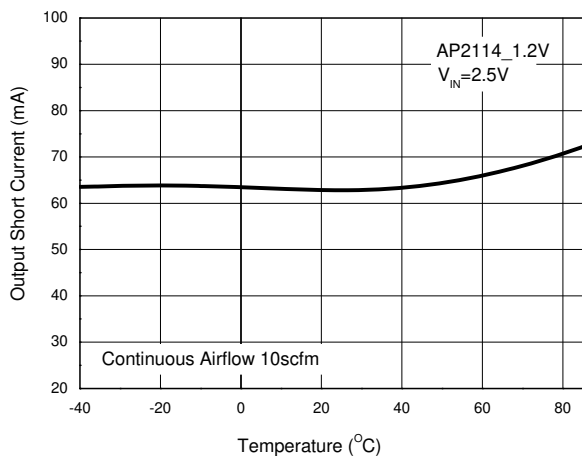

Figure 38. Output Short Current vs. Temperature

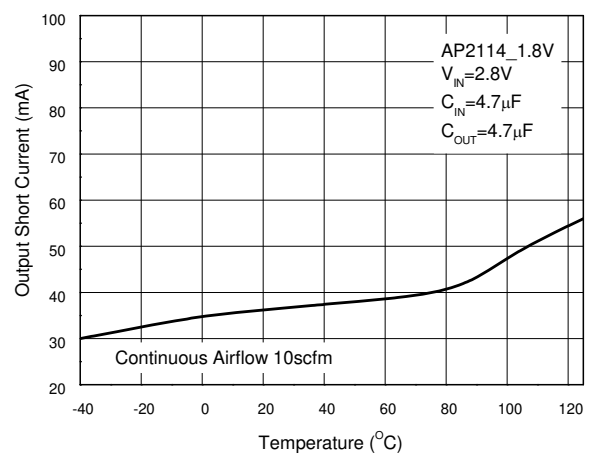

Figure 39. Output Short Current vs. Temperature

**1A LOW NOISE CMOS LDO REGULATOR WITH ENABLE AP2114**

**Typical Performance Characteristics (Continued)**

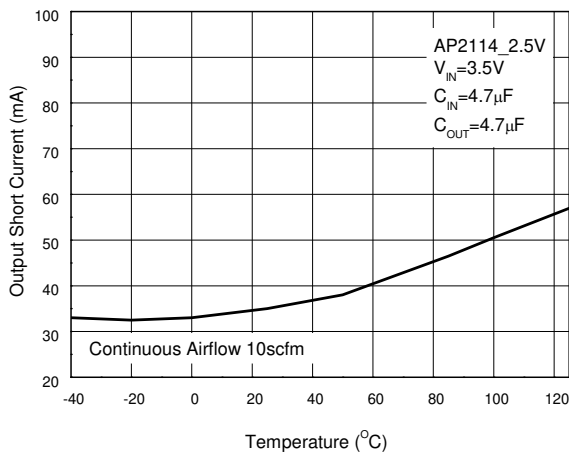

Figure 40. Output Short Current vs. Temperature

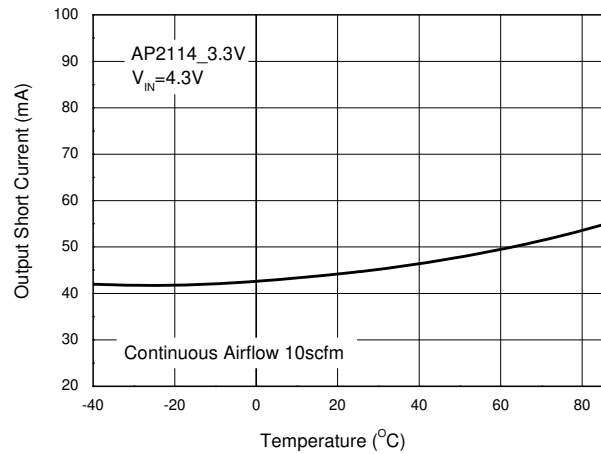

Figure 41. Output Short Current vs. Temperature

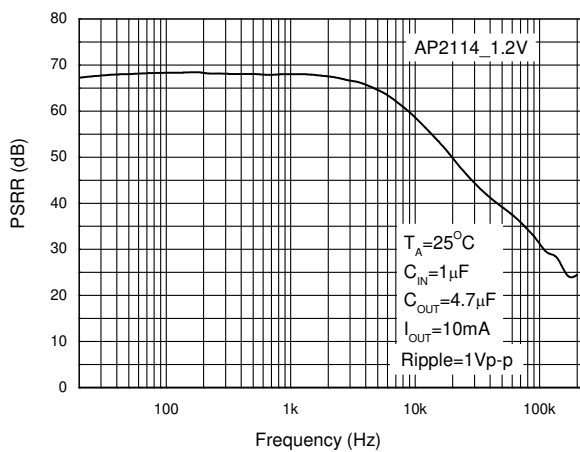

Figure 42. PSRR vs. Frequency

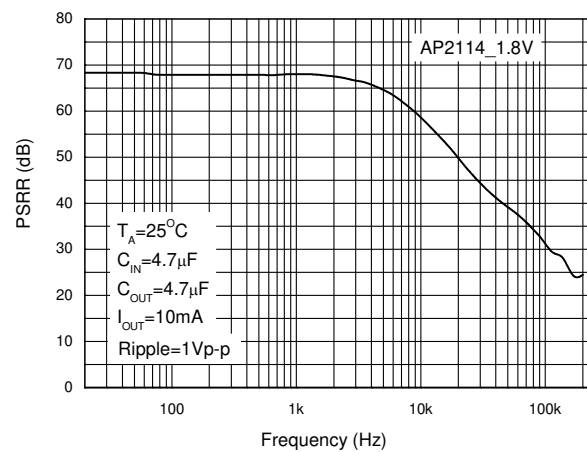

Figure 43. PSRR vs. Frequency



**1A LOW NOISE CMOS LDO REGULATOR WITH ENABLE AP2114**

**Typical Performance Characteristics (Continued)**

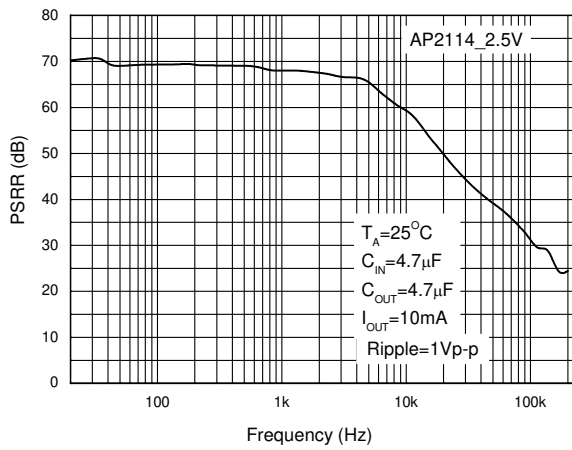

Figure 44. PSRR vs. Frequency

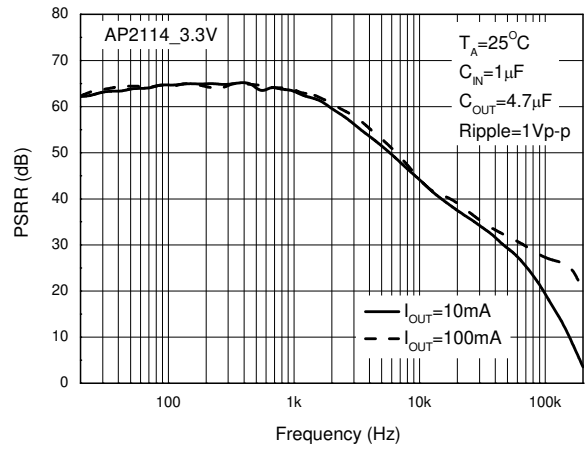

Figure 45. PSRR vs. Frequency

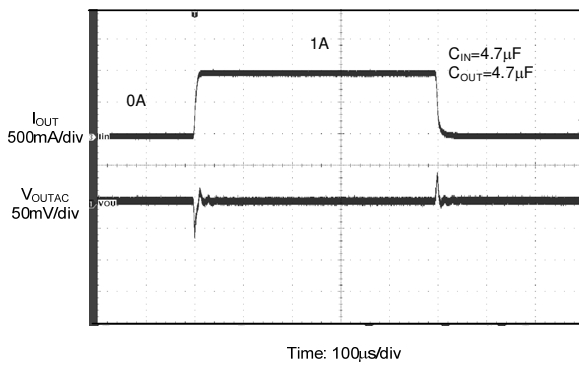

Figure 46. Load Transient

# 1A LOW NOISE CMOS LDO REGULATOR WITH ENABLE AP2114

## Typical Application

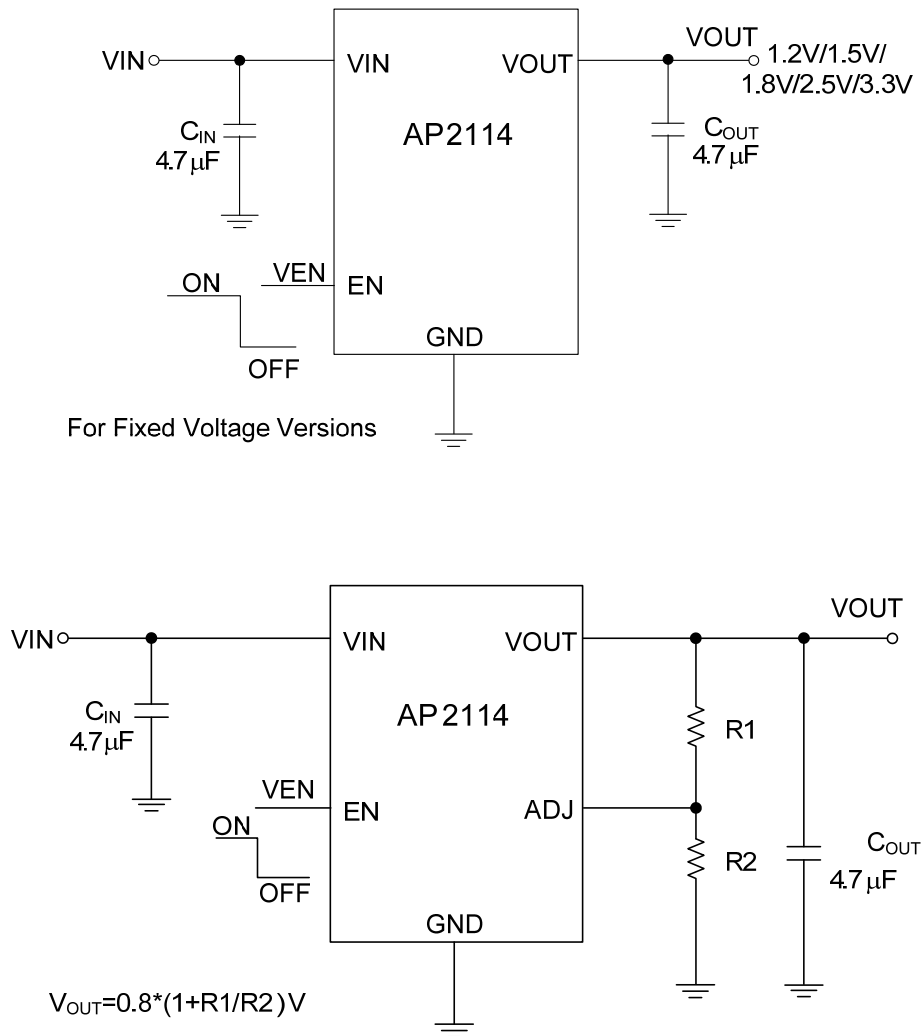

Figure 47. Typical Application of AP2114