



Chipsmall Limited consists of a professional team with an average of over 10 year of expertise in the distribution of electronic components. Based in Hongkong, we have already established firm and mutual-benefit business relationships with customers from,Europe,America and south Asia,supplying obsolete and hard-to-find components to meet their specific needs.

With the principle of “Quality Parts,Customers Priority,Honest Operation,and Considerate Service”,our business mainly focus on the distribution of electronic components. Line cards we deal with include Microchip,ALPS,ROHM,Xilinx,Pulse,ON,Everlight and Freescale. Main products comprise IC,Modules,Potentiometer,IC Socket,Relay,Connector.Our parts cover such applications as commercial,industrial, and automotives areas.

We are looking forward to setting up business relationship with you and hope to provide you with the best service and solution. Let us make a better world for our industry!



Contact us

Tel: +86-755-8981 8866 Fax: +86-755-8427 6832

Email & Skype: info@chipsmall.com Web: www.chipsmall.com

Address: A1208, Overseas Decoration Building, #122 Zhenhua RD., Futian, Shenzhen, China



1.5MHz STEP-UP DC-DC CONVERTER**AP3012****General Description**

The AP3012 is a high power, constant frequency, current mode PWM, inductor based, step-up (boost) converter. The converter operates at high frequency (1.5MHz) so that a small, low profile inductor can be used.

The AP3012 has built-in overvoltage protection (OVP) to allow the device goes into shutdown mode when the output voltage exceeds the OVP threshold of 29V.

The AP3012 is available in standard SOT-23-5 package.

Features

- High Efficiency up to 81%
- Adjustable Output Voltage up to 29V
- Shutdown Current 1 μ A Typical
- 1.5MHz Switching Frequency
- 36V 500mA Rugged Integrated Bipolar Switch
- Built-in Soft-start to Reduce Inrush Current During Start-up
- On-chip Overvoltage Protection
- Uses Low ESR Ceramic Output Capacitor
- Uses Small Inductor

Applications

- LCD/OLED Display Bias Supply
- White LED Driver for LCD Display Backlights
- Cellular Phones

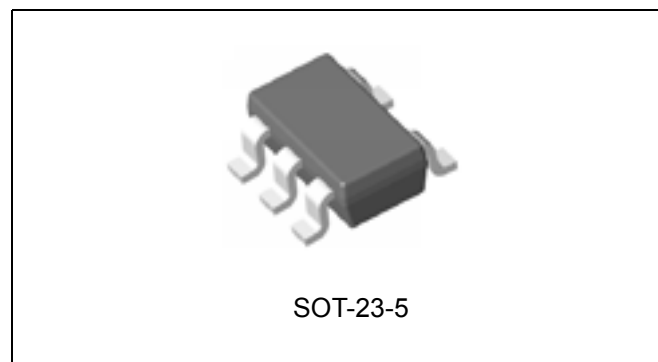

Figure 1. Package Type of AP3012

1.5MHz STEP-UP DC-DC CONVERTER
AP3012
Pin Configuration

Figure 2. Pin Configuration of AP3012 (Top View)

Pin Description

Pin Number	Pin Name	Function
1	SW	Switch Pin. Connect inductor/diode here. The output voltage can go up to 29V but should not exceed this limit. If the voltage on this pin is higher than the overvoltage protection (OVP) threshold, the device can go into shutdown mode. It can be restarted by a low to high pulse on the SHDN pin, or by a power on reset on the V_{IN} supply
2	GND	Ground Pin. Connect directly to local ground plane
3	FB	Feedback Pin. Internally compares to 1.25V. Connect R1 and R2 resistor divider here. Calculate the Output Voltage according to the formula: $V_{OUT}=1.25V * (1+R1/R2)$
4	$\overline{\text{SHDN}}$	Shutdown Pin. Connect to 1.5V or higher to enable device (ON), 0.4V or lower to disable device (OFF)
5	V_{IN}	Input Supply Pin. Must be locally bypassed

1.5MHz STEP-UP DC-DC CONVERTER

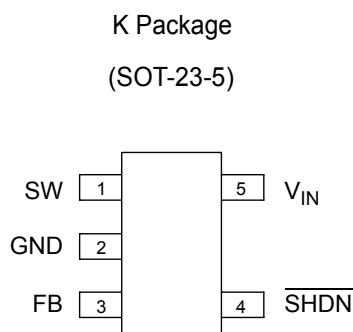
AP3012

Functional Block Diagram

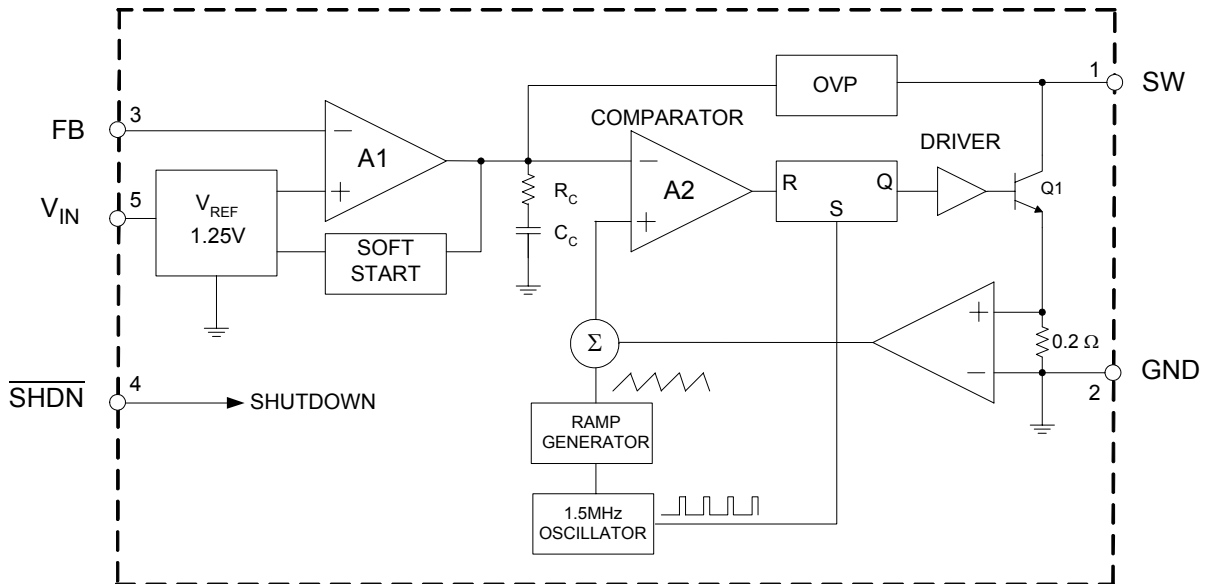
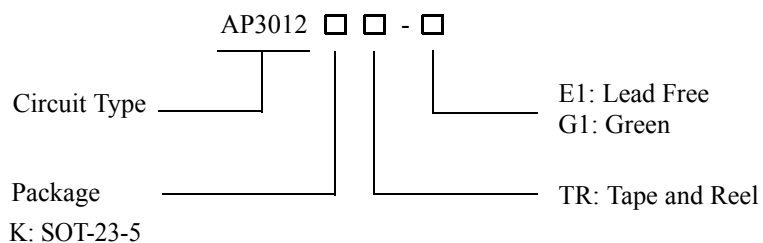

Figure 3. Functional Block Diagram of AP3012

**1.5MHz STEP-UP DC-DC CONVERTER****AP3012****Ordering Information**

Package	Temperature Range	Part Number		Marking ID		Packing Type
		Lead Free	Green	Lead Free	Green	
SOT-23-5	-40 to 85°C	AP3012KTR-E1	AP3012KTR-G1	E6B	G6B	Tape & Reel

BCD Semiconductor's Pb-free products, as designated with "E1" suffix in the part number, are RoHS compliant. Products with "G1" suffix are available in green package.

**1.5MHz STEP-UP DC-DC CONVERTER****AP3012****Absolute Maximum Ratings (Note 1)**

Parameter	Symbol	Value	Unit
Input Voltage	V_{IN}	20	V
SW Voltage		38	V
FB Voltage		5	V
\overline{SHDN} Voltage		16	V
Thermal Resistance (Junction to Atmosphere, no Heat sink)	$R_{\theta JA}$	265	°C/W
Operating Junction Temperature		150	°C
Storage Temperature Range	T_{STG}	-65 to 150	°C
Lead Temperature (Soldering, 10sec)	T_{LEAD}	260	°C
ESD (Machine Model)		250	V
ESD (Human Body Model)		2000	V

Note 1: Stresses greater than those listed under "Absolute Maximum Ratings" may cause permanent damage to the device. These are stress ratings only, and functional operation of the device at these or any other conditions beyond those indicated under "Recommended Operating Conditions" is not implied. Exposure to "Absolute Maximum Ratings" for extended periods may affect device reliability.

Recommended Operating Conditions

Parameter	Symbol	Min	Max	Unit
Input Voltage	V_{IN}	2.6	16	V
Operating Temperature	T_{OP}	-40	85	°C

**1.5MHz STEP-UP DC-DC CONVERTER****AP3012****Electrical Characteristics** $(V_{IN}=3V, \overline{V_{SHDN}}=3V, T_A=25^{\circ}C, \text{ unless otherwise specified.})$

Parameter	Symbol	Conditions	Min	Typ	Max	Unit
Minimum Operating Voltage			2.6			V
Maximum Operating Voltage					16	V
Feedback Voltage	V_{FB}	$V_{IN}=5V, V_{OUT}=24V, I_{OUT}=30mA$	1.17	1.25	1.33	V
FB Pin Bias Current		$V_{FB}=1.25V$	10	45	100	nA
Supply Current	I_{CC}	$\overline{V_{SHDN}}=V_{FB}=V_{IN}$, No switching		2.5	3.5	mA
Supply Current	I_Q	$\overline{V_{SHDN}}=0V, V_{FB}=0V$		0.1	1.0	μA
Switching Frequency	f		1.1	1.5	1.9	MHz
Maximum Duty Cycle	D_{MAX}		85	90		%
Switching Current Limit		Duty Cycle=80%		500		mA
Switch VCESAT	V_{CESAT}	$I_{SW}=250mA$		300		mV
Switch Leakage Current		$V_{SW}=5V$		0.01	5	μA
\overline{SHDN} Voltage High (ON)	V_{TH}		1.5			V
\overline{SHDN} Voltage Low (OFF)	V_{TL}				0.4	
\overline{SHDN} Pin Bias Current				55		μA
OVP Voltage Threshold	V_{OVP}			29		V
Soft-Start Time				550		μS
Thermal Resistance (Junction to Case)	θ_{JC}			69.57		$^{\circ}C/W$



1.5MHz STEP-UP DC-DC CONVERTER

AP3012

Typical Performance Characteristics

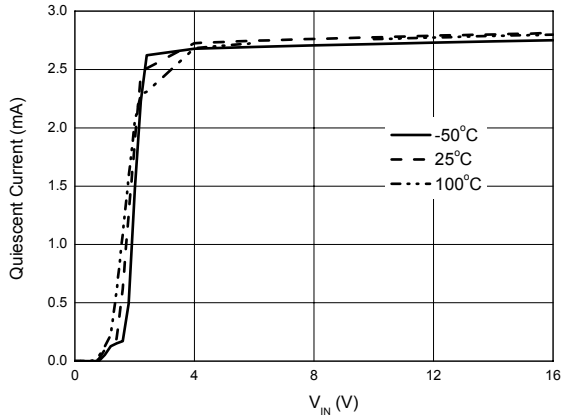

Figure 4. Quiescent Current vs. Input Voltage

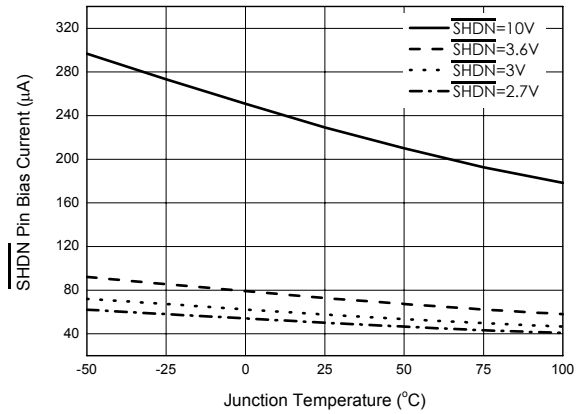

Figure 5. SHDN Pin Bias Current vs. Junction Temperature

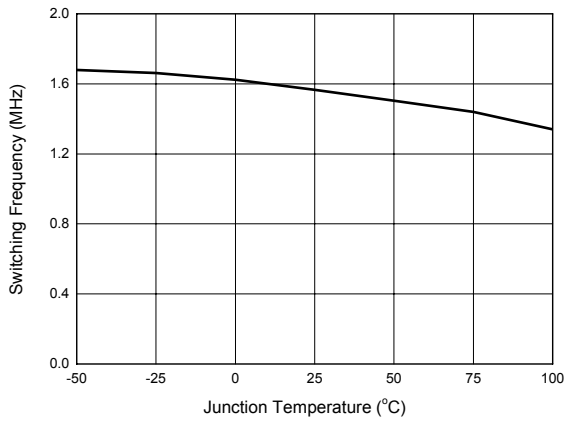

Figure 6. Switching Frequency vs. Junction Temperature

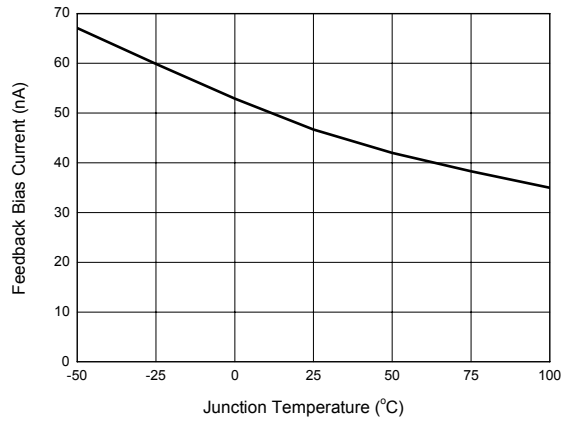

Figure 7. Feedback Bias Current vs. Junction Temperature



1.5MHz STEP-UP DC-DC CONVERTER

AP3012

Typical Performance Characteristics (Continued)

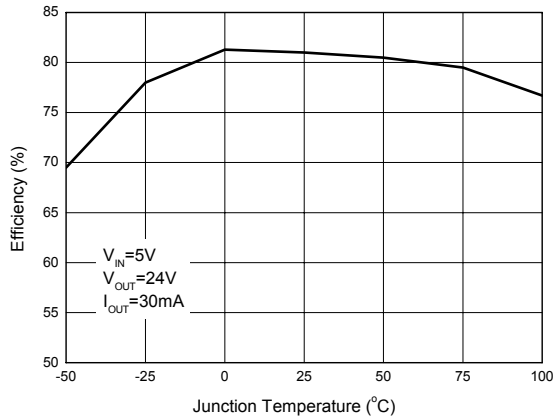

Figure 8. Efficiency vs. Junction Temperature

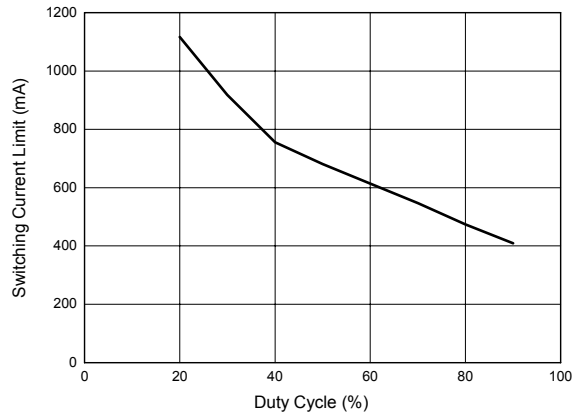

Figure 9. Switching Current Limit vs. Duty Cycle

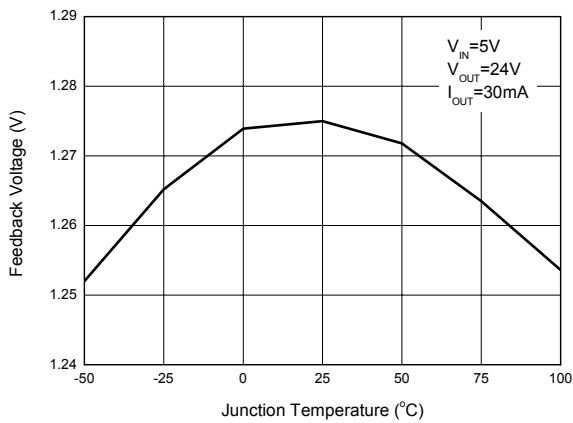

Figure 10. Feedback Voltage vs. Junction Temperature

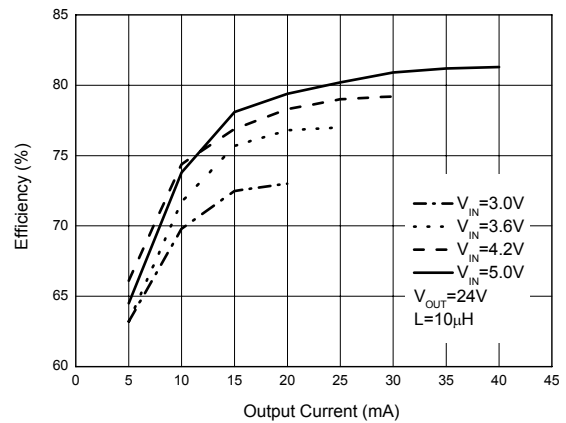
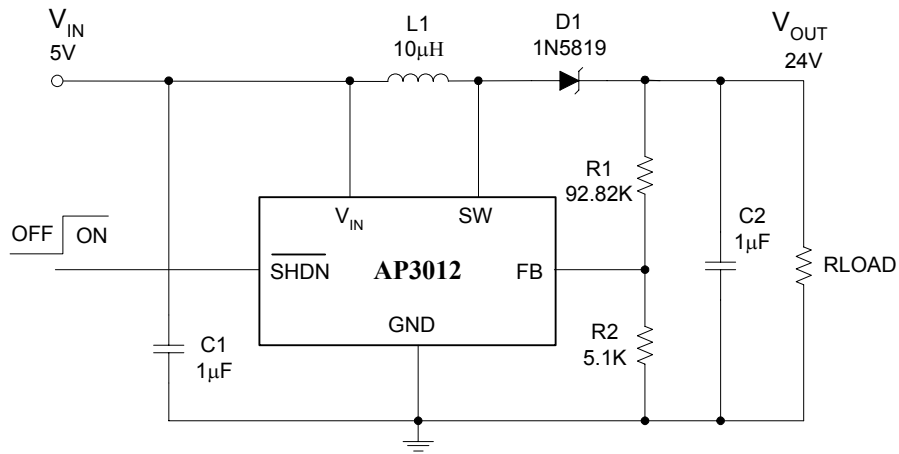

Figure 11. Efficiency vs. Output Current

1.5MHz STEP-UP DC-DC CONVERTER

AP3012

Typical Application



Note: $V_{OUT} = 1.25 * (1 + R1/R2) = 1.25 * 19.2 = 24V$

C: X5R or X7R Dielectric

L: SUMIDA CDTH3D14/HPNP-100NC or Equivalent

Figure 12. LCD/OLED Display Bias Driver Typical Circuit



1.5MHz STEP-UP DC-DC CONVERTER

AP3012

Mechanical Dimensions

SOT-23-5

Unit: mm(inch)

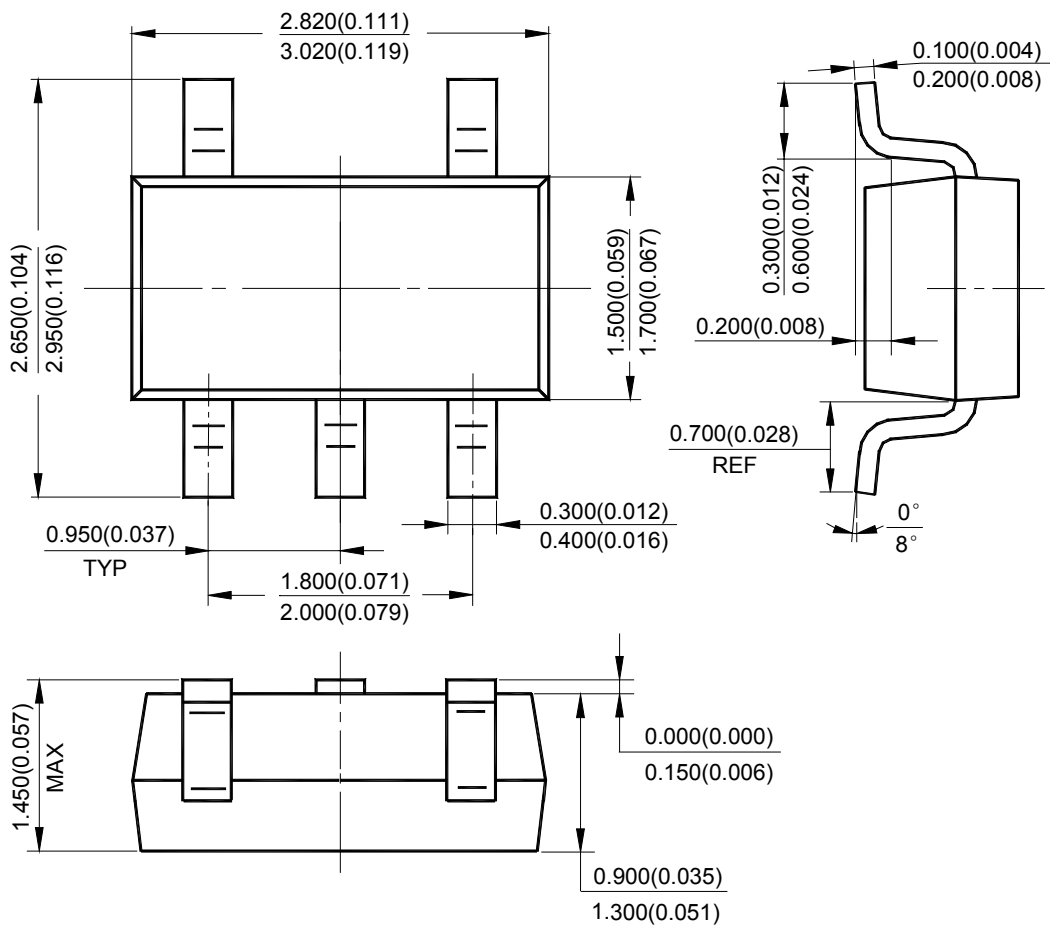



BCD Semiconductor Manufacturing Limited

<http://www.bcdsemi.com>

IMPORTANT NOTICE

BCD Semiconductor Manufacturing Limited reserves the right to make changes without further notice to any products or specifications herein. BCD Semiconductor Manufacturing Limited does not assume any responsibility for use of any its products for any particular purpose, nor does BCD Semiconductor Manufacturing Limited assume any liability arising out of the application or use of any its products or circuits. BCD Semiconductor Manufacturing Limited does not convey any license under its patent rights or other rights nor the rights of others.

MAIN SITE

- Headquarters

BCD Semiconductor Manufacturing Limited

No. 1600, Zi Xing Road, Shanghai ZiZhu Science-based Industrial Park, 200241, China
Tel: +86-21-24162266, Fax: +86-21-24162277

- Wafer Fab

Shanghai SIM-BCD Semiconductor Manufacturing Co., Ltd.

800 Yi Shan Road, Shanghai 200233, China
Tel: +86-21-6485 1491, Fax: +86-21-5450 0008

REGIONAL SALES OFFICE

Shenzhen Office

Shanghai SIM-BCD Semiconductor Manufacturing Co., Ltd., Shenzhen Office

Unit A Room 1203, Skyworth Bldg., Gaoxin Ave. 1.S., Nanshan District, Shenzhen, China
Tel: +86-755-8826 7951
Fax: +86-755-8826 7865

Taiwan Office

BCD Semiconductor (Taiwan) Company Limited

4F, 298-1, Rui Guang Road, Nei-Hu District, Taipei, Taiwan
Tel: +886-2-2656 2808
Fax: +886-2-2656 2806

USA Office

BCD Semiconductor Corp.

30920 Huntwood Ave. Hayward, CA 94544, USA
Tel : +1-510-324-2988
Fax: +1-510-324-2788