



Chipsmall Limited consists of a professional team with an average of over 10 year of expertise in the distribution of electronic components. Based in Hongkong, we have already established firm and mutual-benefit business relationships with customers from,Europe,America and south Asia,supplying obsolete and hard-to-find components to meet their specific needs.

With the principle of “Quality Parts,Customers Priority,Honest Operation,and Considerate Service”,our business mainly focus on the distribution of electronic components. Line cards we deal with include Microchip,ALPS,ROHM,Xilinx,Pulse,ON,Everlight and Freescale. Main products comprise IC,Modules,Potentiometer,IC Socket,Relay,Connector.Our parts cover such applications as commercial,industrial, and automotives areas.

We are looking forward to setting up business relationship with you and hope to provide you with the best service and solution. Let us make a better world for our industry!



## Contact us

Tel: +86-755-8981 8866 Fax: +86-755-8427 6832

Email & Skype: info@chipsmall.com Web: www.chipsmall.com

Address: A1208, Overseas Decoration Building, #122 Zhenhua RD., Futian, Shenzhen, China



**1.5A, 1.4MHZ HIGH EFFICIENCY SYNCHRONOUS DC-DC BUCK CONVERTER**

**Description**

The AP3418 is a 1.4MHz fixed frequency, current mode, PWM synchronous buck (step-down) DC-DC converter, capable of driving a 1.5A load with high efficiency, excellent line and load regulation. The device integrates synchronous P-channel and N-channel power MOSFET switches with low on-resistance. It is ideal for powering portable equipment that runs from a single Li-ion battery.

A standard series of inductors are available from several different manufacturers optimized for use with the AP3418. This feature greatly simplifies the design of switch-mode power supplies.

The AP3418 is available in SOT25 package.

**Features**

- Input Voltage Range: 2.5V to 5.5V
- Output Voltage: 0.6V to  $V_{IN}$
- ADJ Output
- Fixed 1.4MHz Frequency
- High Efficiency up to 95%
- Output Current: 1.5A
- Current Mode Control
- 100% Duty Cycle in Dropout
- Built-in Over Current Protection
- Built-in Short Circuit Protection
- Built-in Thermal Shutdown Protection
- Built-in UVLO Function
- Built-in Soft-start
- **Totally Lead-Free & Fully RoHS Compliant (Notes 1 & 2)**
- **Halogen and Antimony Free. "Green" Device (Note 3)**

- Notes:
1. No purposely added lead. Fully EU Directive 2002/95/EC (RoHS) & 2011/65/EU (RoHS 2) compliant.
  2. See [http://www.diodes.com/quality/lead\\_free.html](http://www.diodes.com/quality/lead_free.html) for more information about Diodes Incorporated's definitions of Halogen- and Antimony-free, "Green" and Lead-free.
  3. Halogen- and Antimony-free "Green" products are defined as those which contain <900ppm bromine, <900ppm chlorine (<1500ppm total Br + Cl) and <1000ppm antimony compounds.

**Pin Assignments**

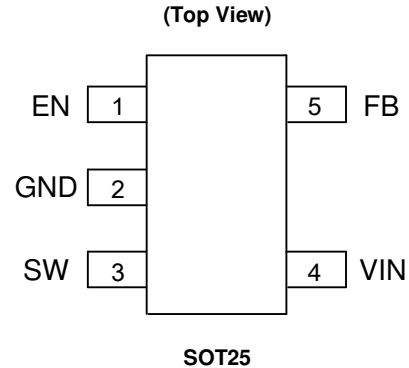

**Applications**

- LCD TV
- Set-top Box
- Datacom
- Portable Device
- Smart Phone

**Typical Applications Circuit**

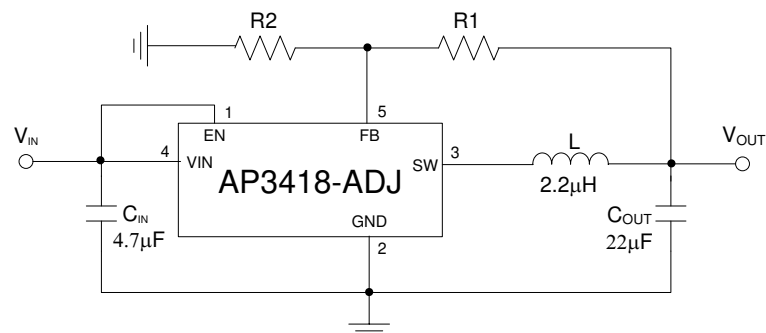

**Pin Descriptions**

Pin Number	Pin Name	Function
1	EN	Control input pin. Forcing this pin above 1.5V enables the IC. Forcing this pin below 0.4V shuts down the IC. When the IC is in shutdown mode, all functions are disabled to decrease the supply current below 1µA
2	GND	Ground pin
3	SW	Power switch output pin. Inductor connection to drain of the internal PFET and NFET switches
4	VIN	Supply input pin. Bypass to GND with a 4.7µF or greater ceramic capacitor
5	FB	This is the feedback pin of the device. Connect this pin directly to the output if the fixed output voltage version is used. For the adjustable version, an external resistor divider is connected to this pin

**Functional Block Diagram**

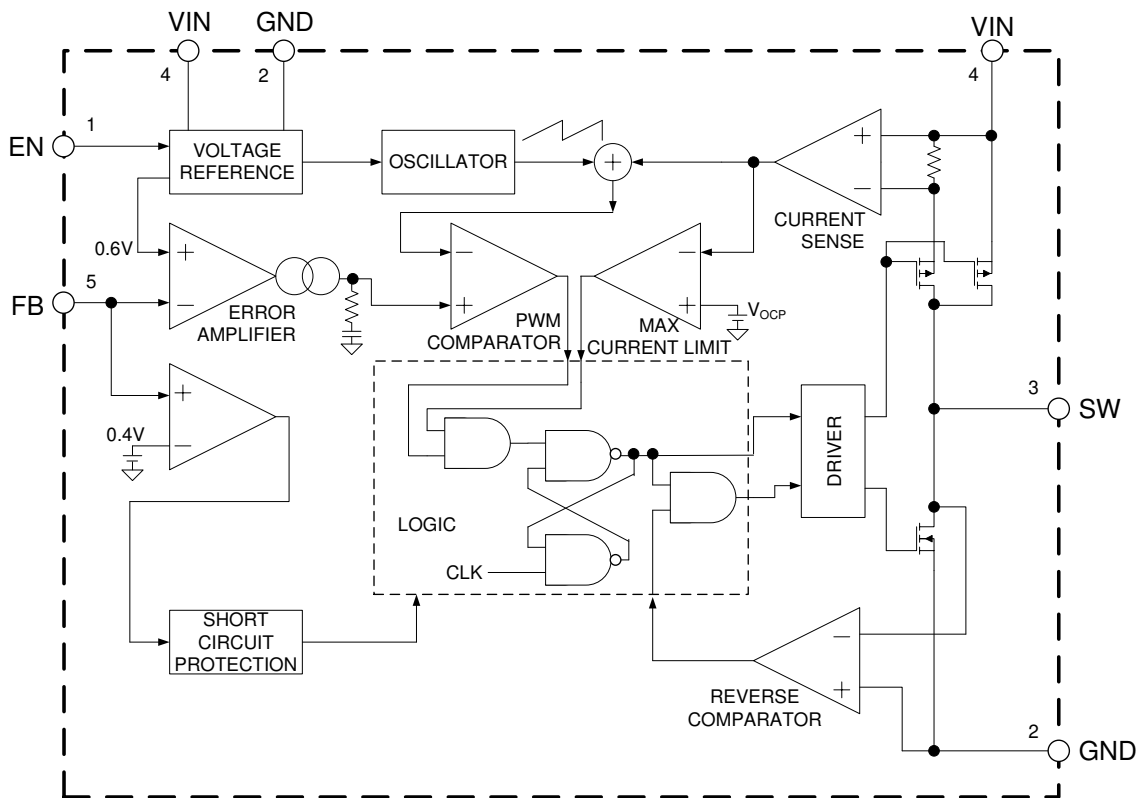

## Absolute Maximum Ratings (Note 4)

Symbol	Parameter	Rating	Unit
$V_{IN}$	Input Voltage	-0.3 to 6.0	V
$V_{FB}$	Feedback Voltage	-0.3 to $V_{IN} + 0.3$	V
$V_{EN}$	EN Pin Voltage	-0.3 to $V_{IN} + 0.3$	V
$V_{SW}$	SW Pin Voltage	-0.3 to $V_{IN} + 0.3$ (Note 5)	V
$\theta_{JA}$	Thermal Resistance	265	°C/W
$T_J$	Operating Junction Temperature	+150	°C
$T_{STG}$	Storage Temperature	-65 to +150	°C
$T_{LEAD}$	Lead Temperature (Soldering, 10sec)	+260	°C
–	ESD(Machine Model)	200	V
–	ESD(Human Body Model)	2000	V

- Notes:
- Stresses greater than those listed under "Absolute Maximum Ratings" may cause permanent damage to the device. These are stress ratings only, and functional operation of the device at these or any other conditions beyond those indicated under "Recommended Operating Conditions" is not implied. Exposure to "Absolute Maximum Ratings" for extended periods may affect device reliability.
  - DC voltage rating, for short period of spike voltage, the minimum voltage rating is -1V, in 20nS.

## Recommended Operating Conditions

Symbol	Parameter	Min	Max	Unit
$V_{IN}$	Input Voltage	2.5	5.5	V
$T_A$	Operating Ambient Temperature	-40	+85	°C



**Electrical Characteristics** ( $V_{IN} = 5V$ ,  $T_A = +25^{\circ}C$ , unless otherwise specified.)

Symbol	Parameter	Conditions	Min	Typ	Max	Unit
$V_{IN}$	Input Voltage	–	2.5	–	5.5	V
$I_Q$	Quiescent Current	$V_{FB} = 0.65V$	–	62	100	$\mu A$
$I_{STBY}$	Shutdown Supply Current	$V_{EN} = GND$	–	0.1	1	$\mu A$
$V_{REF}$	Reference Voltage	For Adjustable Output Voltage	0.588	0.6	0.612	V
$I_{FB\_H}$	Feedback Bias Current	$V_{FB} = 1V$	-0.1	–	0.1	$\mu A$
$I_{FB\_L}$		$V_{FB} = 0V$	-0.1	–	0.1	
$R_{DS(ON)\_P}$	PMOSFET $R_{ON}$	$I_{SW} = 200mA$	–	0.2	–	$\Omega$
$R_{DS(ON)\_N}$	NMOSFET $R_{ON}$	$I_{SW} = -200mA$	–	0.15	–	$\Omega$
$I_{LIM}$	Switch Current Limit	$V_{FB} = 0.55V$	1.8	2.3	–	A
$V_H$	EN Pin Threshold	–	1.5	–	–	V
$V_L$		–	–	–	0.4	
$V_{UVLO}$	UVLO Threshold	$V_{IN}$ Rising	–	2.3	–	V
$V_{HYS}$	UVLO Hysteresis	–	–	0.2	–	
$f_{OSC}$	Oscillator Frequency	–	1.12	1.40	1.68	MHz
$D_{MAX}$	Max. Duty Cycle	–	100	–	–	%
$D_{MIN}$	Min. Duty Cycle	–	–	–	0	
$I_{SW\_H}$	SW Leakage Current	$V_{SW} = 0V$	–	0.1	–	$\mu A$
$I_{SW\_L}$		$V_{SW} = 5V$	–	0.1	–	
$t_{SS}$	Soft-start Time	–	–	1	–	ms
$T_{OTSD}$	Thermal Shutdown	–	–	+160	–	$^{\circ}C$
$T_{HYS}$	Thermal Shutdown Hysteresis	–	–	+20	–	$^{\circ}C$

**Performance Characteristics** ( $V_{IN} = 5V$ ,  $T_A = +25^\circ C$ , unless otherwise specified.)

**Efficiency vs. Output Current**

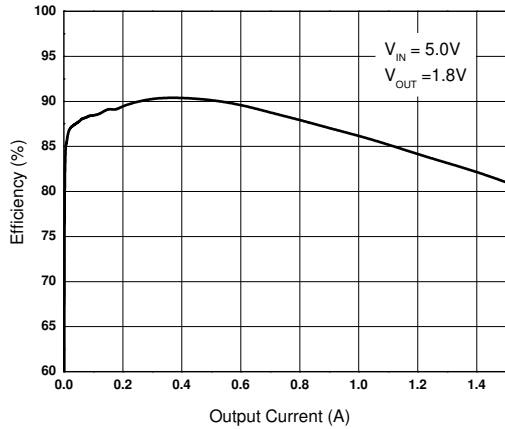

**Efficiency vs. Input Voltage**

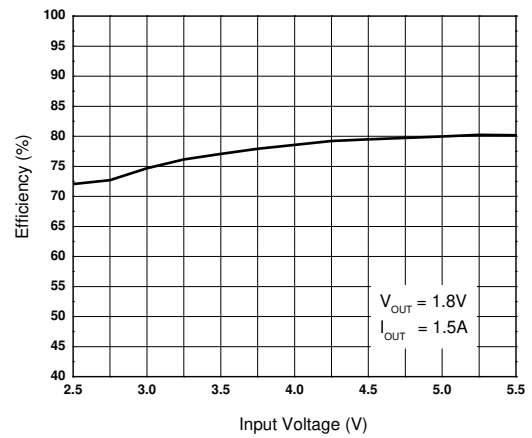

**Reference Voltage vs. Temperature**

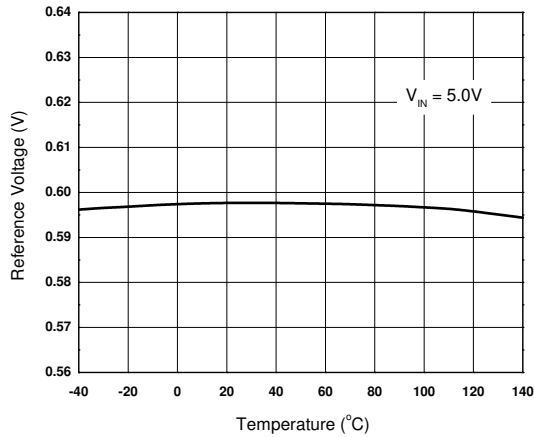

**Switch Current Limit vs. Temperature**

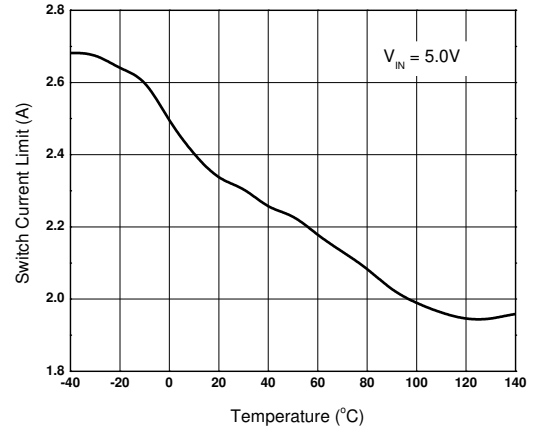

**Frequency vs. Input Voltage**

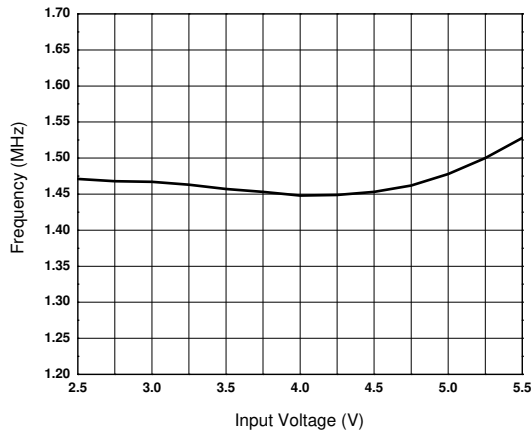

**Frequency vs. Temperature**

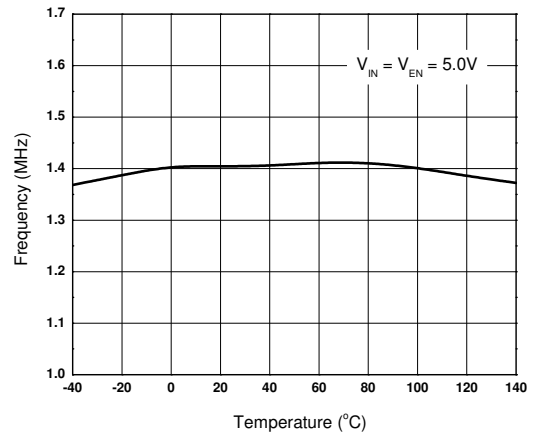

**Performance Characteristics** (Cont.  $V_{IN} = 5V$ ,  $T_A = +25^\circ C$ , unless otherwise specified.)

**$R_{DS(ON\_UP)}$  vs. Temperature**

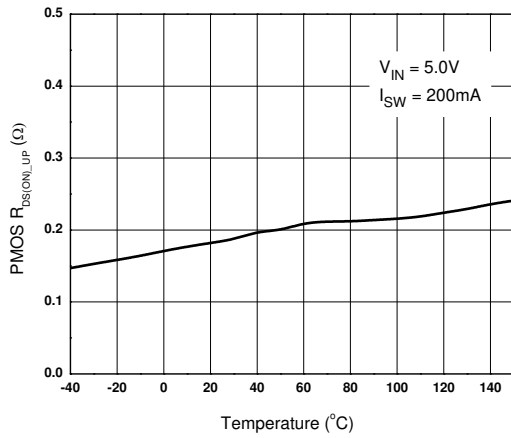

**$R_{DS(ON\_DOWN)}$  vs. Temperature**

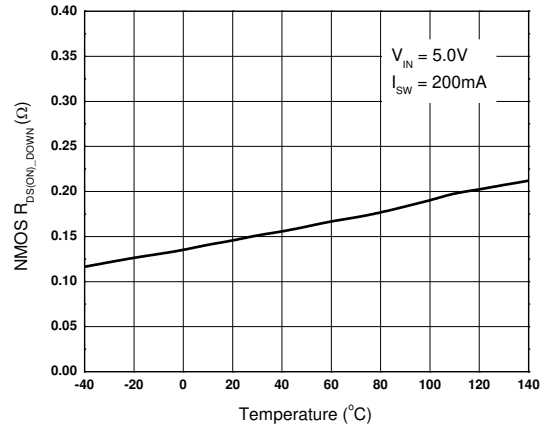

**Output Ripple ( $I_{OUT} = 0A$ )**

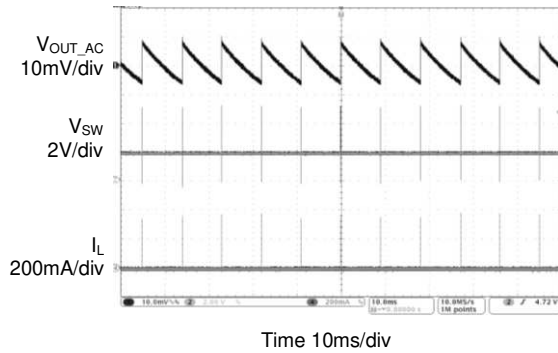

**Output Ripple ( $I_{OUT} = 1.5A$ )**

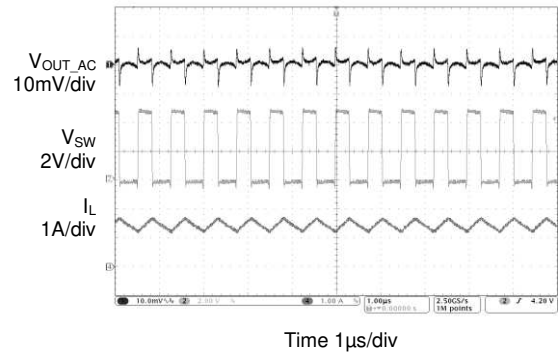

**Enable Turn on ( $I_{OUT} = 1.5A$ )**

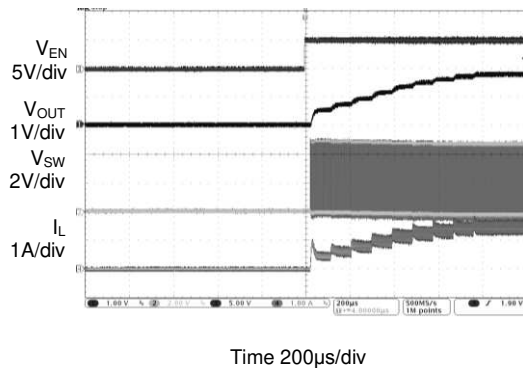

**Enable Turn off ( $I_{OUT} = 1.5A$ )**

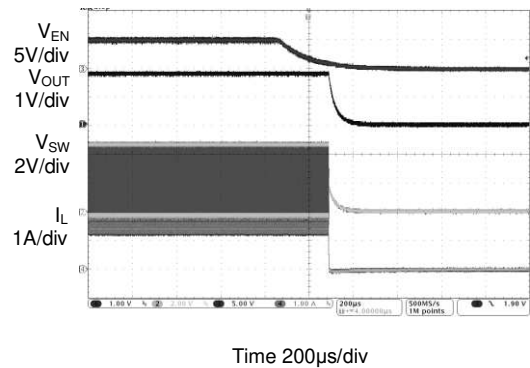

**Performance Characteristics** (Cont.  $V_{IN} = 5V$ ,  $T_A = +25^{\circ}C$ , unless otherwise specified.)

**Short Circuit Protection**  
( $I_{OUT} = 1.5A$ )

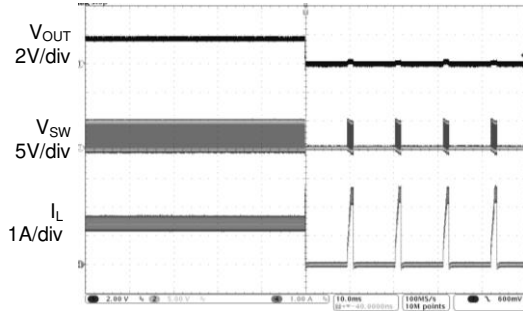

Time 10ms/div

**Short Circuit Protection Recovery**  
( $I_{OUT} = 1.5A$ )

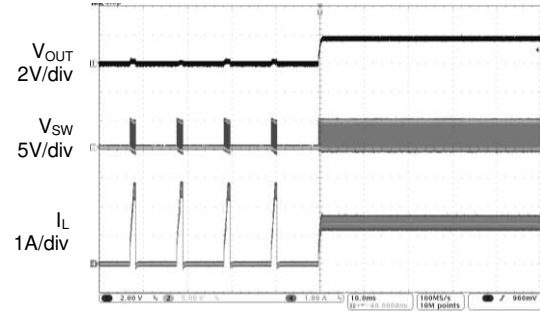

Time 10ms/div



**Ordering Information**

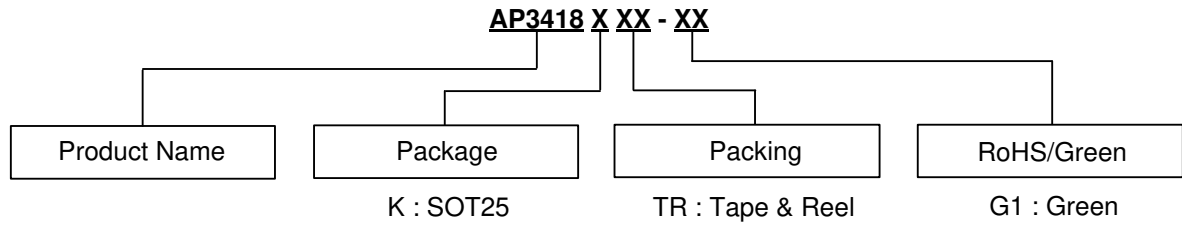

Package	Temperature Range	Part Number	Marking ID	Packing
SOT25	-40 to +85 °C	AP3418KTR-G1	G5E	3000/Tape & Reel

**Marking Information**

(Top View)

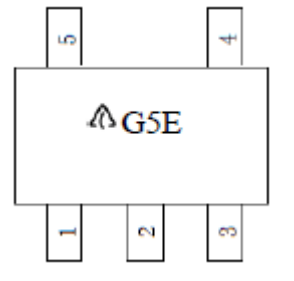

: Logo  
G5E: Marking ID

**Package Outline Dimensions** (All dimensions in mm(inch).)

(1) Package Type: SOT25

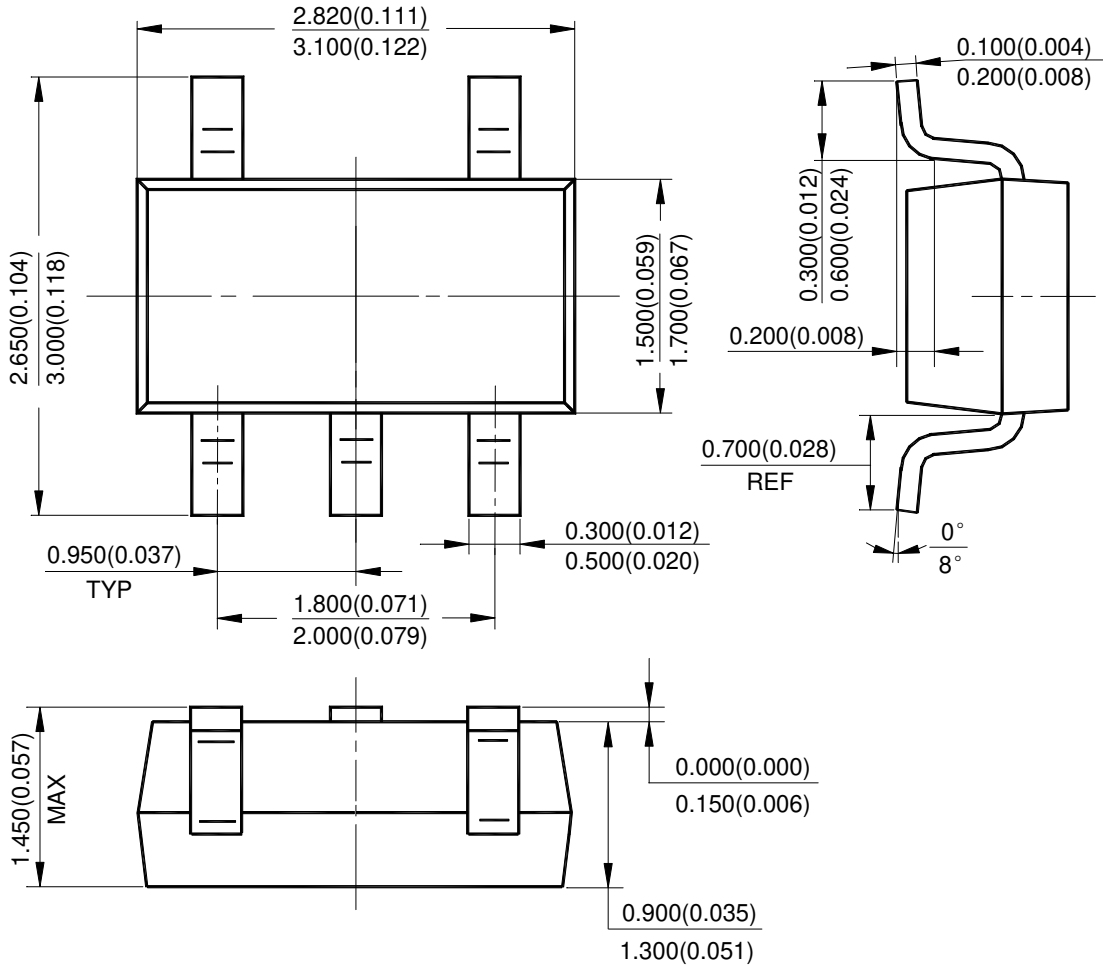

**Suggested Pad Layout**

(1) Package Type: SOT25

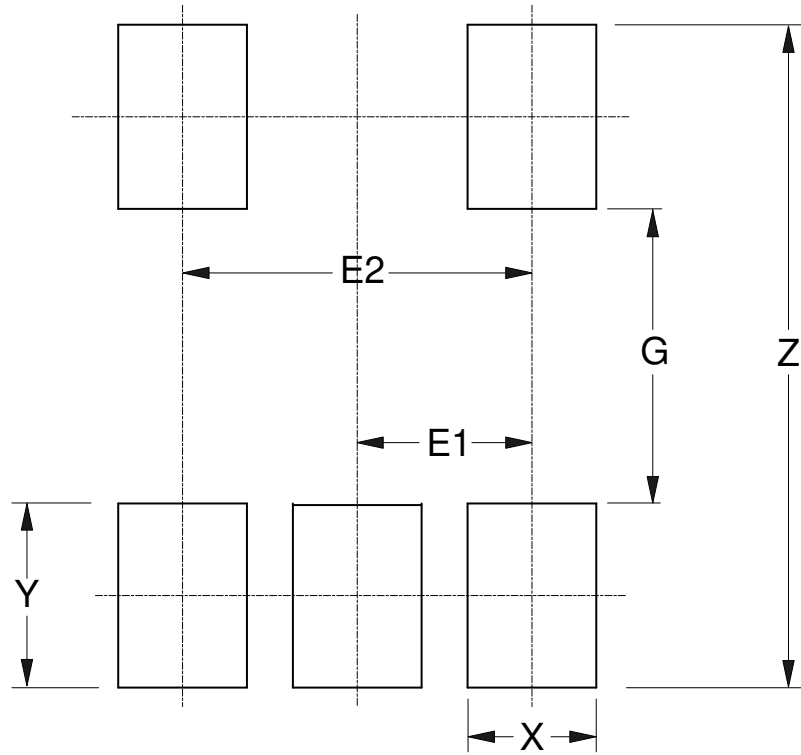

Dimensions	Z (mm)/(inch)	G (mm)/(inch)	X (mm)/(inch)	Y (mm)/(inch)	E1 (mm)/(inch)	E2 (mm)/(inch)
Value	3.600/0.142	1.600/0.063	0.700/0.028	1.000/0.039	0.950/0.037	1.900/0.075

**IMPORTANT NOTICE**

DIODES INCORPORATED MAKES NO WARRANTY OF ANY KIND, EXPRESS OR IMPLIED, WITH REGARDS TO THIS DOCUMENT, INCLUDING, BUT NOT LIMITED TO, THE IMPLIED WARRANTIES OF MERCHANTABILITY AND FITNESS FOR A PARTICULAR PURPOSE (AND THEIR EQUIVALENTS UNDER THE LAWS OF ANY JURISDICTION).

Diodes Incorporated and its subsidiaries reserve the right to make modifications, enhancements, improvements, corrections or other changes without further notice to this document and any product described herein. Diodes Incorporated does not assume any liability arising out of the application or use of this document or any product described herein; neither does Diodes Incorporated convey any license under its patent or trademark rights, nor the rights of others. Any Customer or user of this document or products described herein in such applications shall assume all risks of such use and will agree to hold Diodes Incorporated and all the companies whose products are represented on Diodes Incorporated website, harmless against all damages.

Diodes Incorporated does not warrant or accept any liability whatsoever in respect of any products purchased through unauthorized sales channel. Should Customers purchase or use Diodes Incorporated products for any unintended or unauthorized application, Customers shall indemnify and hold Diodes Incorporated and its representatives harmless against all claims, damages, expenses, and attorney fees arising out of, directly or indirectly, any claim of personal injury or death associated with such unintended or unauthorized application.

Products described herein may be covered by one or more United States, international or foreign patents pending. Product names and markings noted herein may also be covered by one or more United States, international or foreign trademarks.

This document is written in English but may be translated into multiple languages for reference. Only the English version of this document is the final and determinative format released by Diodes Incorporated.

**LIFE SUPPORT**

Diodes Incorporated products are specifically not authorized for use as critical components in life support devices or systems without the express written approval of the Chief Executive Officer of Diodes Incorporated. As used herein:

A. Life support devices or systems are devices or systems which:

1. are intended to implant into the body, or
2. support or sustain life and whose failure to perform when properly used in accordance with instructions for use provided in the labeling can be reasonably expected to result in significant injury to the user.

B. A critical component is any component in a life support device or system whose failure to perform can be reasonably expected to cause the failure of the life support device or to affect its safety or effectiveness.

Customers represent that they have all necessary expertise in the safety and regulatory ramifications of their life support devices or systems, and acknowledge and agree that they are solely responsible for all legal, regulatory and safety-related requirements concerning their products and any use of Diodes Incorporated products in such safety-critical, life support devices or systems, notwithstanding any devices- or systems-related information or support that may be provided by Diodes Incorporated. Further, Customers must fully indemnify Diodes Incorporated and its representatives against any damages arising out of the use of Diodes Incorporated products in such safety-critical, life support devices or systems.

Copyright © 2014, Diodes Incorporated

[www.diodes.com](http://www.diodes.com)