



Chipsmall Limited consists of a professional team with an average of over 10 year of expertise in the distribution of electronic components. Based in Hongkong, we have already established firm and mutual-benefit business relationships with customers from,Europe,America and south Asia,supplying obsolete and hard-to-find components to meet their specific needs.

With the principle of “Quality Parts,Customers Priority,Honest Operation,and Considerate Service”,our business mainly focus on the distribution of electronic components. Line cards we deal with include Microchip,ALPS,ROHM,Xilinx,Pulse,ON,Everlight and Freescale. Main products comprise IC,Modules,Potentiometer,IC Socket,Relay,Connector.Our parts cover such applications as commercial,industrial, and automotives areas.

We are looking forward to setting up business relationship with you and hope to provide you with the best service and solution. Let us make a better world for our industry!



Contact us

Tel: +86-755-8981 8866 Fax: +86-755-8427 6832

Email & Skype: info@chipsmall.com Web: www.chipsmall.com

Address: A1208, Overseas Decoration Building, #122 Zhenhua RD., Futian, Shenzhen, China



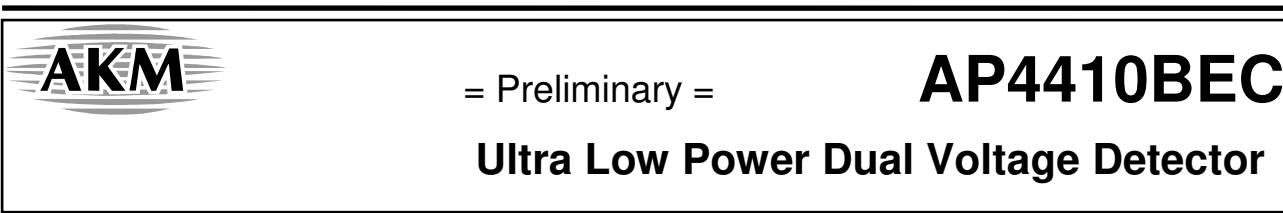

1. General Description

The AP4410BEC is a voltage detector IC for monitoring battery, power supply and system voltage. The circuit includes dual voltage detection with built-in gate logic and MOSFETs. The AP4410BEC offers ultra-low power consumption that is 0.026 μ A per channel.

The built-in CMOS logic circuit can be controlled independently from the voltage detector. The polarity of the voltage detection results is controlled by pins. This function enables the AP4410BEC as a load switch by using the results of the voltage detection. The AP4410BEC achieves better performance and PCB area than conventional CMOS voltage detection ICs, with discrete logics and external MOSFETs. The AP4410BEC is ideal for voltage conversion or load switch of thin and small wearable devices, over charge/discharge protection of Lithium-ion batteries, power management part of energy harvesting applications.

2. Features

- Power management function
 - Dual voltage detection circuits
 - Control logic with independent power supply
 - Built in P-channel MOSFETs and N-Channel MOSFETs for each channel
- Wide range for detection voltage

Detection voltage "High"	1.8 to 4.4V (Options)
Detection voltage "Low"	1.7 to 4.3V (Options)
- Voltage detection accuracy ± 35 mV
- Ultra-low power consumption 0.026 μ A typical/ch. 0.050 μ A maximum/ ch
- Response Speed 500 μ s maximum
- On resistance

On-chip P-channel MOSFETs	1 Ω typical
On-chip N-channel MOSFETs	2 Ω typical
- Operation temperature -40 - 85 °C
- Package 20-pin WLCSP (1.955 \times 1.555mm, 0.4mm pitch)

3. Table of Contents

1. General Description.....	1
2. Features.....	1
3. Table of Contents	2
4. Block Diagram	3
5. Pin Configuration and Function.....	4
■ Pin Configuration	4
■ Function	4
6. Absolute Maximum Ratings.....	5
7. Recommended Operating Conditions.....	5
8. Electrical Characteristics	6
9. Description.....	7
■ Voltage Detection Function.....	7
10. Package	9
■ Outline Dimensions	9
■ Marking	9
11. Revision History	10
IMPORTANT NOTICE.....	11

4. Block Diagram

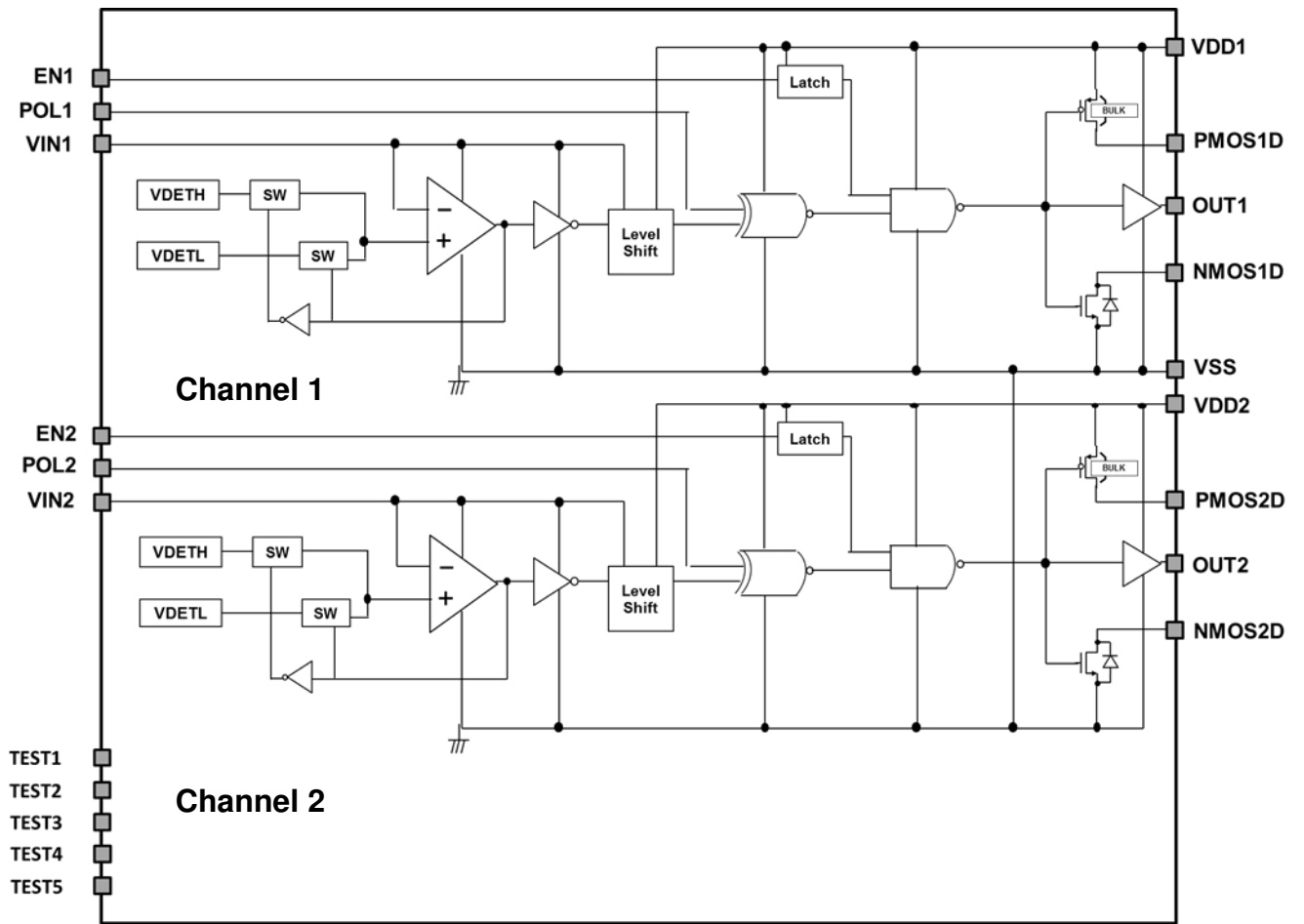
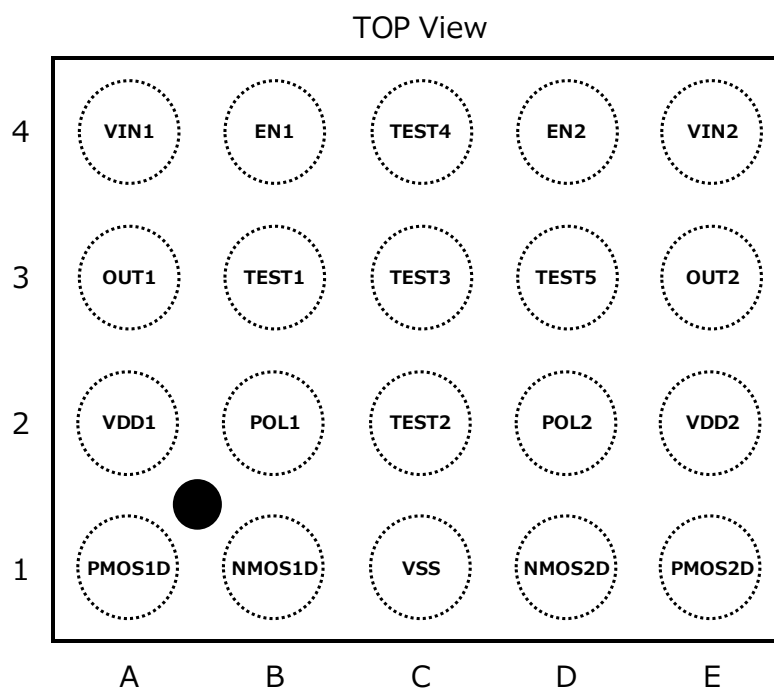

Figure 1. Block Diagram

5. Pin Configuration and Function

■ Pin Configuration

• 20-pin WLCSP



■ Function

WLCSP Pin	Pin Name	I/O	Function
A1	PMOS1D	Input/Output	PMOS drain pin (Channel 1)
A2	VDD1	Power	Power supply(Channel 1)
A3	OUT1	Output	Logic output (Channel 1)
A4	VIN1	Power	Detection input pin (Channel 1)
B1	NMOS1D	Output	NMOS1 drain pin(Channel 1)
B2	POL1	Input	Polarity cotrol pin (Channel 1)
B3	TEST1	-	For test purposes. This pin should be connected to VSS.
B4	EN1	Input	Enable pin (Channel 1)
C1	VSS	Ground	Ground
C2	TEST2	-	For test purposes. This pin should be connected to VSS.
C3	TEST3	-	For test purposes. This pin should be connected to VSS.
C4	TEST4	-	For test purposes. This pin should be connected to VSS.
D1	NMOS2D	Output	NMOS drain pin(Channel 2)
D2	POL2	Input	Polarity cotrol pin (Channel 2)
D3	TEST5	-	For test purposes. This pin should be connected to VSS.
D4	EN2	Input	Enable pin (Channel 2)
E1	PMOS2D	Input / Output	PMOS drain pin (Channel 2)
E2	VDD2	Power	Power supply(Channel 2)
E3	OUT2	Output	Logic output (Channel 2)
E4	VIN2	Power	Detection input pin (Channel 2)

6. Absolute Maximum Ratings

Parameter	Symbol	min	max	Unit
Pin Voltage (Note 1)	VIN1,VIN2, VDD1,VDD2	-0.3	6.5	V
	OUT1,EN1,POL1	VSS-0.3	VDD1 + 0.3	V
	OUT2,EN2,POL2	VSS-0.3	VDD2 + 0.3	V
	PMOS1D PMOS2D	-0.3	6.5	V
	NMOS1D NMOS2D	-0.3	6.5	V
Power dissipation	Pd	-	0.8	W
Storage Temperature	Tstg	-55	150	°C

Note 1. All voltages are with reference to VSS = 0 V.

WARNING: Stresses exceeding Maximum Ratings may damage the device. Normal operation is not guarantee if the condition exceeds the maximum rating.

7. Recommended Operating Conditions

Parameter	Symbol	min	max	Unit
Operation Temperature	Ta	-40	85	°C
Power Supply Voltage	VIN1 VIN2 VDD1 VDD2	1.2	5.5	V

8. Electrical Characteristics

(Ta= -40 to 85°C, VIN1, VIN2, VDD1 and VDD2 =1.2V to 5.5V, OUT=open, PMOSD=open, NMOSD=open, unless otherwise specified.)

Parameter	Symbol	min	typ	max	Unit	Condition
Detection Voltage "High"	V _{DETH}	V _{DETH} -0.035	V _{DETH}	V _{DETH} +0.035	V	Ta=25°C VIN= "L" → "H"
		V _{DETH} -0.045		V _{DETH} +0.045	V	Ta=85°C VIN= "L" → "H"
Detection Voltage "Low"	V _{DETL}	V _{DETL} -0.035	V _{DETL}	V _{DETL} +0.035	V	Ta=25°C VIN= "H" → "L"
		V _{DETL} -0.045		V _{DETL} +0.045	V	Ta=85°C VIN= "H" → "L"
Power Consumption	IVIN	-	0.026	0.050	μA	Consumption for VIN per channel while the voltage detection circuit is active.
	IVDD (Note 2) (Note 3)	-	0.0001	0.100	μA	Consumption for VDD1 and VDD2.
"High" Level Input Voltage	V _{IH}	VDD × 0.8	-	-	V	
"Low" Level Input Voltage	V _{IL}	-	-	VDD × 0.2	V	
EN pin reverse current (Push, Pull Note 4)	I _{EN}	0.15	-	-	μA	
IOH (Note 5)	I _{OH}	0.15	-	-	mA	VIN=V _{DETH} +0.1V, OUT=VDD-0.5V
IOL(Note 5)	I _{OL}	0.2	-	-	mA	VIN=V _{DETL} -0.1V, OUT=0.5V
Response Time (Note 6)	t _{PLH}	-	0.2	0.5	ms	VIN=V _{DETH} -0.1V→V _{DETH} +0.1V VIN= V _{DETL} +0.1V→V _{DETL} -0.1V
	t _{PHL}	-	0.2	0.5	ms	
P-ch MOSFET On-resistance	R _{onP}	-	1	2.3	Ω	VDD ≥ 1.7V
N-ch MOSFET On-resistance	R _{onN}	-	2	5	Ω	VDD ≥ 1.7V

Note 2. Output drive is not included.

Note 3. Total power consumption VDD1 and VDD2 (VDD1+VDD2).

Note 4. EN pin has latch function to keep status. When current comes into or goes out from the EN pin is smaller than the specified value. The AK4110BEC keeps status.

Note 5. Output current depends on VDD1 and VDD2.

IOL shows N-Channel pull current when AP4410BEC OUT1/OUT2 output low.

IOH shows P-Channel push current when AP4410BEC OUT1/OUT2 output high.

Note 6. Response time for OUT1 pin and OUT2 pin

9. Description

■ Voltage Detection Function

VIN1 pin and VIN2 pin = (Abbreviation ;VIN)
 VDD1 pin and VDD2 pin = (Abbreviation ;VDD)
 POL1 pin and POL2 pin = (Abbreviation ;POL)
 EN1 pin and EN2 pin = (Abbreviation ;EN)

- 1) When the input voltage is increasing,
 The OUT1 pin and OUT2 pin(Abbreviation ;OUT) will be in undefined status when VIN voltage is from VSS to AP4410BEC minimum operating voltage(1.2V). The AP4410BEC internal signal A(Please refer Figure 2) outputs VSS when VIN voltage exceeds minimum operating voltage. When VIN voltage reaches to the detection voltage (VDETH), the internal signal A outputs VIN voltage.
- 2) When the input voltage is decreasing,
 When VIN voltage is higher than VDETH, internal signal A outputs VIN. When VIN goes under the detection voltage (VDETL), OUT outputs VSS. The internal signal A will be undefined status when VIN voltage becomes lower than AP4410BEC minimum operating voltage(1.2V).

The logic inputs POL and EN become valid when VDD voltage exceeds 1.2V which is the minimum operation voltage. In case of POL = "L", EN="H", OUT behaves as Figure. 3. The AP4410BEC is able to output the inverted results of the voltage detection using POL. EN can control P-channel MOSFET and N-channel MOSFET ON and OFF. EN has latch function so that it keeps its present state if the input becomes Hi-Z. The BULK of the P-channel MOSFET is connected to the higher voltage pin between VDD and PMOSD.

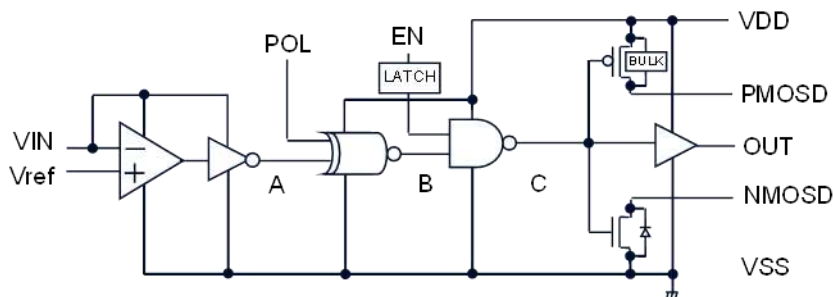

Figure 2. Block Diagram of Control Logic Part (Each channel)

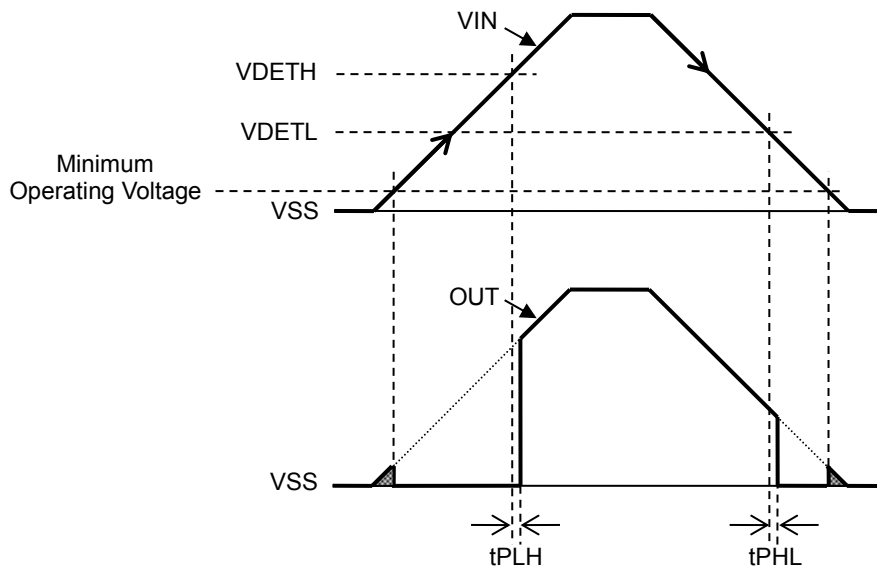

Figure 3. Function of AP4410BEC voltage detection

Table 1. Control logic truth table (Note 7)

POL input	VIN	EN input	Internal signal A	Internal signal B	Internal signal C	PMOSD	NMOSD	OUT	Note
L	$V_{IN} < V_{DETH}$	L	L	H	H	OPEN	L	H	-
L	$V_{IN} < V_{DETH}$	H	L	H	L	H	OPEN	L	OUT= positive polarity
L	$V_{IN} \geq V_{DETH}$	H	H	L	H	OPEN	L	H	
L	$V_{IN} \geq V_{DETH}$	L	H	L	H	OPEN	L	H	-
H	$V_{IN} < V_{DETH}$	L	L	L	H	OPEN	L	H	-
H	$V_{IN} < V_{DETH}$	H	L	L	H	OPEN	L	H	OUT= negative polarity
H	$V_{IN} \geq V_{DETH}$	H	H	H	L	H	OPEN	L	
H	$V_{IN} \geq V_{DETH}$	L	H	H	H	OPEN	L	H	-

Note 7. When the VIN voltage is increasing from VDETL or lower.

Table 2 Control logic truth table (Note 8)

POL input	VIN	EN input	Internal signal A	Internal signal B	Internal signal C	PMOSD	NMOSD	OUT	Note
L	$V_{IN} > V_{DETL}$	L	H	L	H	OPEN	L	H	-
L	$V_{IN} > V_{DETL}$	H	H	L	H	OPEN	L	H	OUT= positive polarity
L	$V_{IN} \leq V_{DETL}$	H	L	H	L	H	OPEN	L	
L	$V_{IN} \leq V_{DETL}$	L	L	H	H	OPEN	L	H	-
H	$V_{IN} > V_{DETL}$	L	H	H	H	OPEN	L	H	-
H	$V_{IN} > V_{DETL}$	H	H	H	L	H	OPEN	L	OUT= negative polarity
H	$V_{IN} \leq V_{DETL}$	H	L	L	H	OPEN	L	H	
H	$V_{IN} \leq V_{DETL}$	L	L	L	H	OPEN	L	H	-

Note 8. When the VIN voltage is decreasing from VDETH or higher.

10. Package

■ **Outline Dimensions**

20-pin WLCSP (Unit: mm)

When the IC is exposed to light, it might affect the electrical characteristics of the IC due to the light sensitivity of WLCSP package structures.

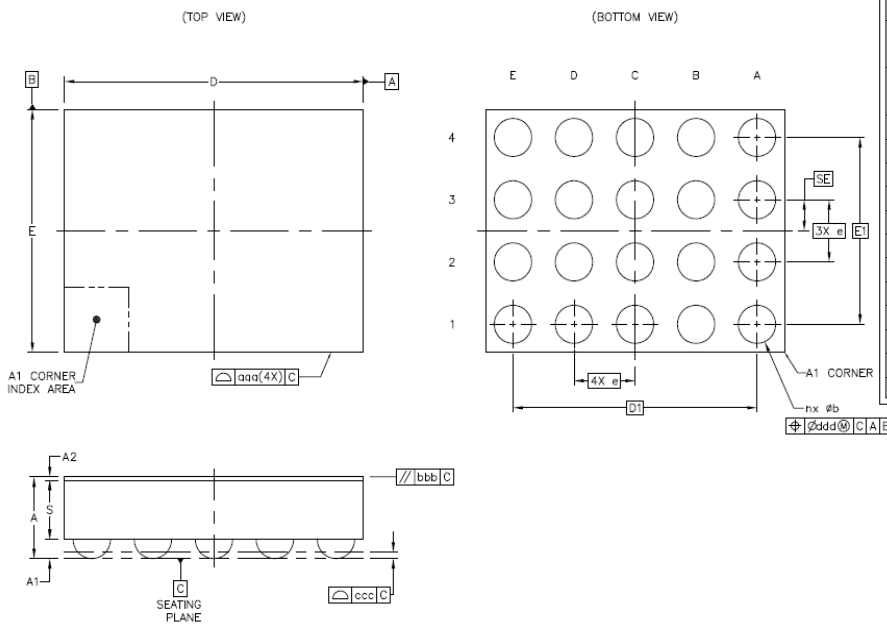

	SYMBOL	COMMON DIMENSIONS
TOTAL THICKNESS	A	0.525 ± 0.031
WAFER THICKNESS	S	0.378 ± 0.012
STAND OFF	A1	0.11 ~ 0.14
FILM THICKNESS	A2	0.022 ± 0.004
BODY SIZE	X D	1.96
	Y E	1.56
BALL/BUMP PITCH	X SD	---
	Y SE	0.2 BSC
EDGE BALL CENTER TO CENTER	X D1	1.6 BSC
	Y E1	1.2 BSC
PITCH	e	0.4 BSC
BALL DIAMETER (SIZE)		0.2
BALL/BUMP WIDTH	b	0.215 ~ 0.275
BALL/BUMP COUNT	n	20
PACKAGE EDGE TOLERANCE	aaa	0.03
WAFER FLATNESS	bbb	0.06
COPLANARITY	ccc	0.04
BALL/BUMP OFFSET (PACKAGE)	ddd	0.015

■ **Marking**

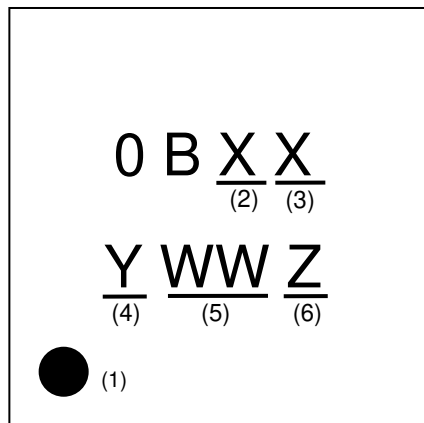

- (1) 1 Pin Indication
- (2) Symbol of the detection voltage of system 1
- (3) Symbol of the detection voltage of system 2
- (4) Year code (last 1 digit)
- (5) Week code
- (6) Management code

11. Revision History

Date (YY/MM/DD)	Revision	Page	Contents
2017/12/18	0	-	The first edition

IMPORTANT NOTICE

0. Asahi Kasei Microdevices Corporation (“AKM”) reserves the right to make changes to the information contained in this document without notice. When you consider any use or application of AKM product stipulated in this document (“Product”), please make inquiries the sales office of AKM or authorized distributors as to current status of the Products.
1. All information included in this document are provided only to illustrate the operation and application examples of AKM Products. AKM neither makes warranties or representations with respect to the accuracy or completeness of the information contained in this document nor grants any license to any intellectual property rights or any other rights of AKM or any third party with respect to the information in this document. You are fully responsible for use of such information contained in this document in your product design or applications. AKM ASSUMES NO LIABILITY FOR ANY LOSSES INCURRED BY YOU OR THIRD PARTIES ARISING FROM THE USE OF SUCH INFORMATION IN YOUR PRODUCT DESIGN OR APPLICATIONS.
2. The Product is neither intended nor warranted for use in equipment or systems that require extraordinarily high levels of quality and/or reliability and/or a malfunction or failure of which may cause loss of human life, bodily injury, serious property damage or serious public impact, including but not limited to, equipment used in nuclear facilities, equipment used in the aerospace industry, medical equipment, equipment used for automobiles, trains, ships and other transportation, traffic signaling equipment, equipment used to control combustions or explosions, safety devices, elevators and escalators, devices related to electric power, and equipment used in finance-related fields. Do not use Product for the above use unless specifically agreed by AKM in writing.
3. Though AKM works continually to improve the Product’s quality and reliability, you are responsible for complying with safety standards and for providing adequate designs and safeguards for your hardware, software and systems which minimize risk and avoid situations in which a malfunction or failure of the Product could cause loss of human life, bodily injury or damage to property, including data loss or corruption.
4. Do not use or otherwise make available the Product or related technology or any information contained in this document for any military purposes, including without limitation, for the design, development, use, stockpiling or manufacturing of nuclear, chemical, or biological weapons or missile technology products (mass destruction weapons). When exporting the Products or related technology or any information contained in this document, you should comply with the applicable export control laws and regulations and follow the procedures required by such laws and regulations. The Products and related technology may not be used for or incorporated into any products or systems whose manufacture, use, or sale is prohibited under any applicable domestic or foreign laws or regulations.
5. Please contact AKM sales representative for details as to environmental matters such as the RoHS compatibility of the Product. Please use the Product in compliance with all applicable laws and regulations that regulate the inclusion or use of controlled substances, including without limitation, the EU RoHS Directive. AKM assumes no liability for damages or losses occurring as a result of noncompliance with applicable laws and regulations.
6. Resale of the Product with provisions different from the statement and/or technical features set forth in this document shall immediately void any warranty granted by AKM for the Product and shall not create or extend in any manner whatsoever, any liability of AKM.
7. This document may not be reproduced or duplicated, in any form, in whole or in part, without prior written consent of AKM.