



Chipsmall Limited consists of a professional team with an average of over 10 year of expertise in the distribution of electronic components. Based in Hongkong, we have already established firm and mutual-benefit business relationships with customers from,Europe,America and south Asia,supplying obsolete and hard-to-find components to meet their specific needs.

With the principle of “Quality Parts,Customers Priority,Honest Operation,and Considerate Service”,our business mainly focus on the distribution of electronic components. Line cards we deal with include Microchip,ALPS,ROHM,Xilinx,Pulse,ON,Everlight and Freescale. Main products comprise IC,Modules,Potentiometer,IC Socket,Relay,Connector.Our parts cover such applications as commercial,industrial, and automotives areas.

We are looking forward to setting up business relationship with you and hope to provide you with the best service and solution. Let us make a better world for our industry!



## Contact us

Tel: +86-755-8981 8866 Fax: +86-755-8427 6832

Email & Skype: info@chipsmall.com Web: www.chipsmall.com

Address: A1208, Overseas Decoration Building, #122 Zhenhua RD., Futian, Shenzhen, China



**Thunderbolt IGBT®**

The Thunderbolt IGBT® is a new generation of high voltage power IGBTs. Using Non-Punch-Through Technology, the Thunderbolt IGBT® offers superior ruggedness and ultrafast switching speed.

**Features**

- Low Forward Voltage Drop
- Low Tail Current
- Integrated Gate Resistor
- Low EMI, High Reliability
- RoHS Compliant 
- RBSOA and SCSOA Rated
- High Frequency Switching to 50KHz
- Ultra Low Leakage Current

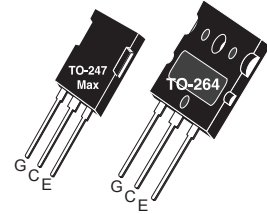

**Maximum Ratings**

 All Ratings:  $T_C = 25^\circ C$  unless otherwise specified.

Symbol	Parameter	Ratings	Unit
$V_{CES}$	Collector-Emitter Voltage	600	Volts
$V_{GE}$	Gate-Emitter Voltage	$\pm 30$	
$I_{C1}$	Continuous Collector Current @ $T_C = 25^\circ C$	148	Amps
$I_{C2}$	Continuous Collector Current @ $T_C = 100^\circ C$	80	
$I_{CM}$	Pulsed Collector Current <sup>①</sup>	300	
SSOA	Switching Safe Operating Area @ $T_J = 150^\circ C$	300A @ 600V	
$P_D$	Total Power Dissipation	500	Watts
$T_J, T_{STG}$	Operating and Storage Junction Temperature Range	-55 to 150	$^\circ C$

**Static Electrical Characteristics**

Symbol	Characteristic / Test Conditions	Min	Typ	Max	Unit
$V_{(BR)CES}$	Collector-Emitter Breakdown Voltage ( $V_{GE} = 0V, I_C = 4mA$ )	600	-	-	Volts
$V_{GE(TH)}$	Gate Threshold Voltage ( $V_{CE} = V_{GE}, I_C = 1.5mA, T_J = 25^\circ C$ )	3	4	5	
$V_{CE(ON)}$	Collector Emitter On Voltage ( $V_{GE} = 15V, I_C = 100A, T_J = 25^\circ C$ )	1.7	2.1	2.5	
	Collector Emitter On Voltage ( $V_{GE} = 15V, I_C = 100A, T_J = 125^\circ C$ )	-	2.5	-	
$I_{CES}$	Collector Cut-off Current ( $V_{CE} = 600V, V_{GE} = 0V, T_J = 25^\circ C$ ) <sup>②</sup>	-	-	25	$\mu A$
	Collector Cut-off Current ( $V_{CE} = 600V, V_{GE} = 0V, T_J = 125^\circ C$ ) <sup>②</sup>	-	-	1000	
$I_{GES}$	Gate-Emitter Leakage Current ( $V_{GE} = \pm 30V$ )	-	-	300	nA

 CAUTION: These Devices are Sensitive to Electrostatic Discharge. Proper Handling Procedures Should Be Followed.

## Dynamic Characteristic

APT100GT60B2R\_LR(G)

Symbol	Characteristic	Test Conditions	Min	Typ	Max	Unit	
$C_{ies}$	Input Capacitance	$V_{GE} = 0V, V_{CE} = 25V$ $f = 1MHz$	-	5150	-	pF	
$C_{oes}$	Output Capacitance		-	475	-		
$C_{res}$	Reverse Transfer Capacitance		-	295	-		
$V_{GEP}$	Gate-to-Emitter Plateau Voltage	Gate Charge $V_{GE} = 15V$ $V_{CE} = 300V$ $I_C = 100A$	-	8.0	-	V	
$Q_g$	Total Gate Charge <sup>③</sup>		-	460	-	nC	
$Q_{ge}$	Gate-Emitter Charge		-	40	-		
$Q_{gc}$	Gate-Collector Charge		-	210	-		
SSOA	Switching Safe Operating Area	$T_J = 150^\circ C, R_G = 4.3\Omega, V_{GE} = 15V,$ $L = 100\mu H, V_{CE} = 600V$	300			A	
$t_{d(on)}$	Turn-On Delay Time	Inductive Switching (25°C) $V_{CC} = 400V$ $V_{GE} = 15V$ $I_C = 100A$ $R_G = 4.3\Omega$ $T_J = +25^\circ C$	-	40	-	ns	
$t_r$	Current Rise Time		-	75	-		
$t_{d(off)}$	Turn-Off Delay Time		-	320	-		
$t_f$	Current Fall Time		-	100	-		
$E_{on1}$	Turn-On Switching Energy <sup>④</sup>		-	3250	-		$\mu J$
$E_{on2}$	Turn-On Switching Energy <sup>⑤</sup>	-	3525	-			
$E_{off}$	Turn-Off Switching Energy <sup>⑥</sup>	-	3125	-			
$t_{d(on)}$	Turn-On Delay Time	Inductive Switching (125°C) $V_{CC} = 400V$ $V_{GE} = 15V$ $I_C = 100A$ $R_G = 4.3\Omega$ $T_J = +125^\circ C$	-	40	-	ns	
$t_r$	Current Rise Time		-	75	-		
$t_{d(off)}$	Turn-Off Delay Time		-	350	-		
$t_f$	Current Fall Time		-	100	-		
$E_{on1}$	Turn-On Switching Energy <sup>④</sup>		-	3275	-		$\mu J$
$E_{on2}$	Turn-On Switching Energy <sup>⑤</sup>		-	4650	-		
$E_{off}$	Turn-Off Switching Energy <sup>⑥</sup>		-	3750	-		

## Thermal and Mechanical Characteristics

Symbol	Characteristic / Test Conditions	Min	Typ	Max	Unit
$R_{\theta JC}$	Junction to Case (IGBT)	-	-	0.25	$^\circ C/W$
$R_{\theta JC}$	Junction to Case (DIODE)	-	-	N/A	
$W_T$	Package Weight	-	29.2	-	g
Torque	Terminals and Mounting Screws	-	-	10	in·lbf
		-	-	1.1	N·m

① Repetitive Rating: Pulse width limited by maximum junction temperature.

② For Combi devices,  $I_{ces}$  includes both IGBT and FRED leakages.

③ See MIL-STD-750 Method 3471.

④  $E_{on1}$  is the clamped inductive turn-on energy of the IGBT only, without the effect of a commutating diode reverse recovery current adding to  $z$  a the IGBT turn-on loss. Tested in inductive switching test circuit shown in figure 21, but with a Silicon Carbide diode.

⑤  $E_{on2}$  is the clamped inductive turn-on energy that includes a commutating diode reverse recovery current in the IGBT turn-on switching loss. (See Figures 21, 22.)

⑥  $E_{off}$  is the clamped inductive turn-off energy measured in accordance with JEDEC standard JESD24-1. (See Figures 21, 23.)

⑦  $R_G$  is external gate resistance not including gate driver impedance.

Microsemi reserves the right to change, without notice, the specifications and information contained herein.

# Typical Performance Curves

APT100GT60B2R\_LR(G)

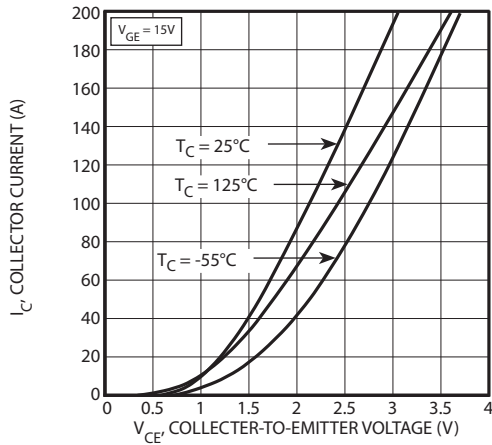

FIGURE 1, Output Characteristics ( $V_{GE} = 15V$ )

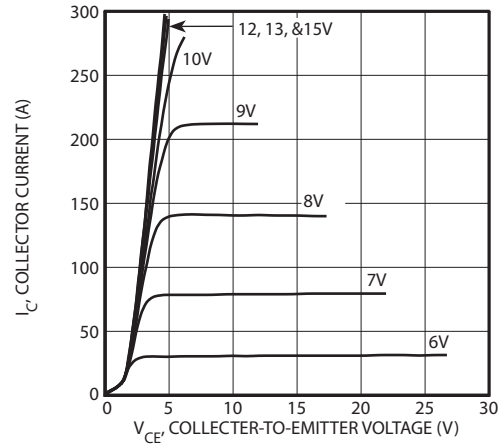

FIGURE 2, Output Characteristics ( $T_J = 125^\circ C$ )

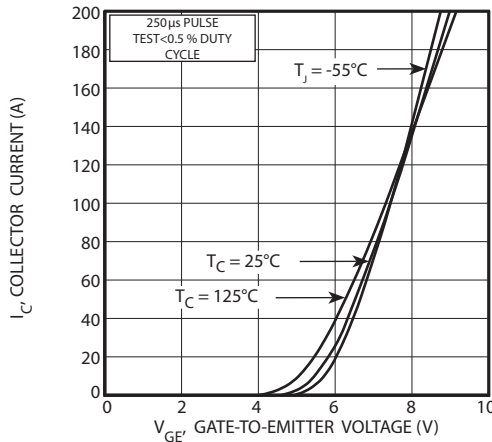

FIGURE 3, Transfer Characteristics

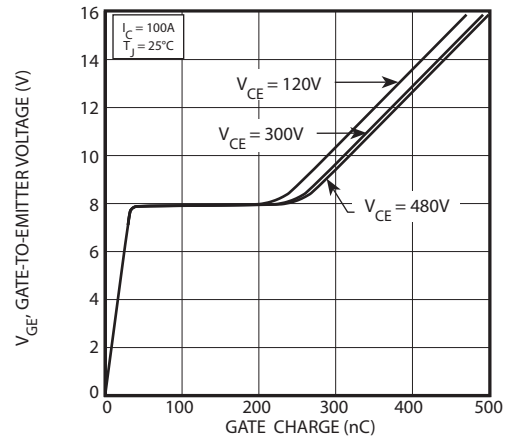

FIGURE 4, Gate Charge

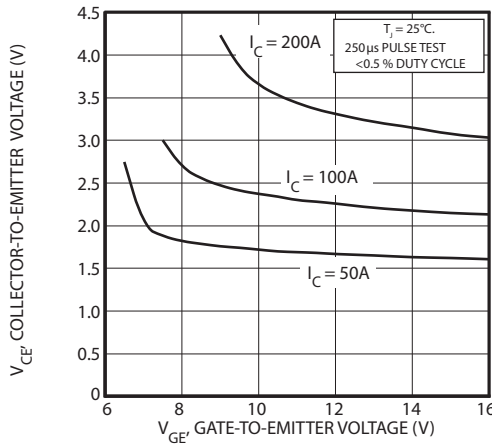

FIGURE 5, On State Voltage vs Gate-to-Emitter Voltage

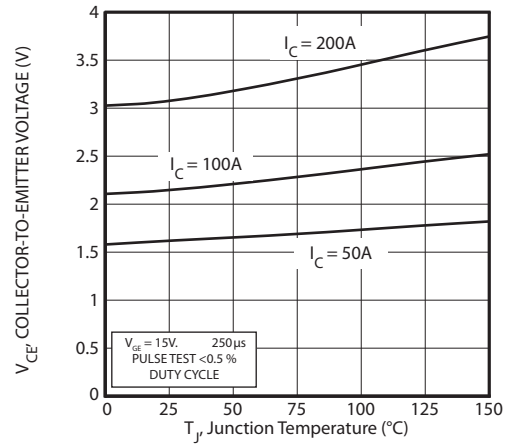

FIGURE 6, On State Voltage vs Junction Temperature

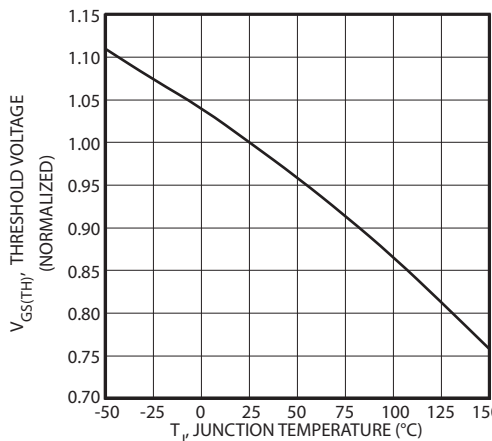

FIGURE 7, Threshold Voltage vs. Junction Temperature

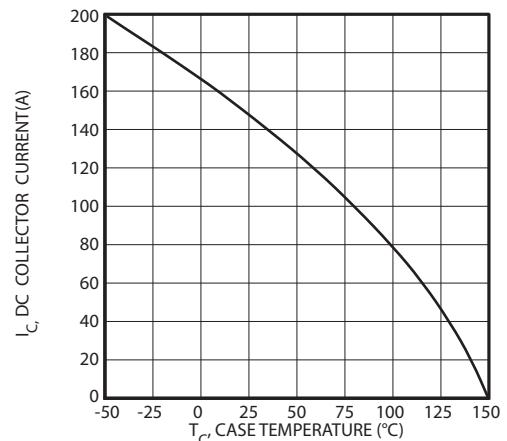

FIGURE 8, DC Collector Current vs Case Temperature

Typical Performance Curves

APT100GT60B2R\_LR(G)

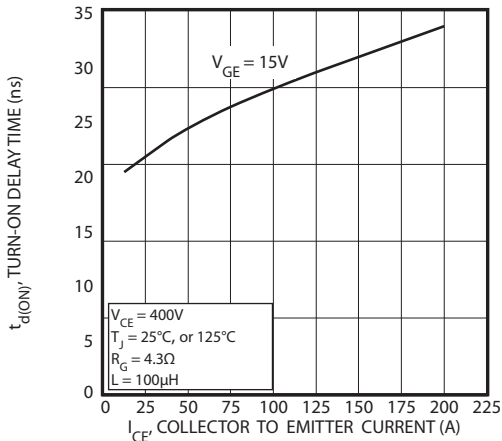

FIGURE 9, Turn-On Delay Time vs Collector Current

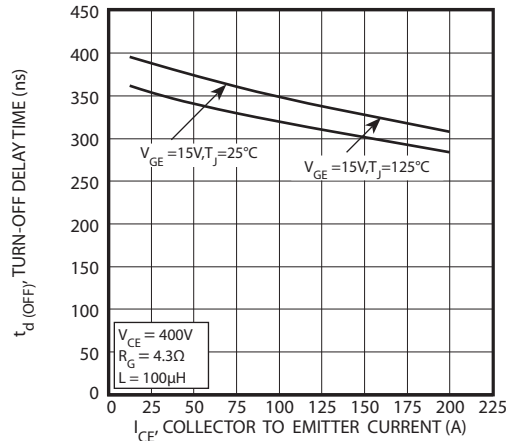

FIGURE 10, Turn-Off Delay Time vs Collector Current

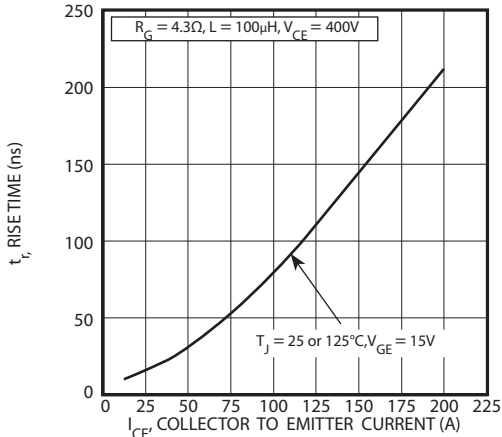

FIGURE 11, Current Rise Time vs Collector Current

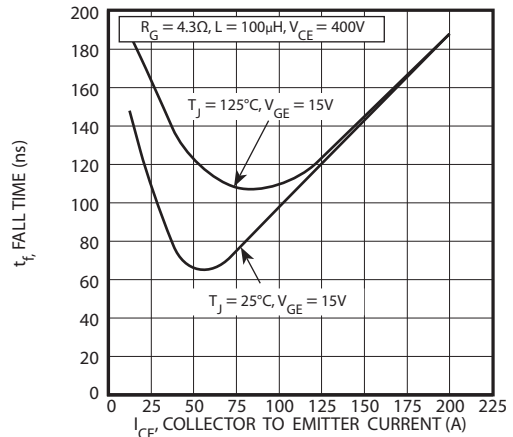

FIGURE 12, Current Fall Time vs Collector Current

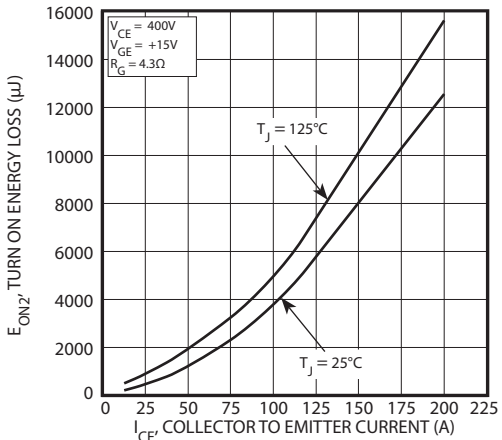

FIGURE 13, Turn-On Energy Loss vs Collector Current

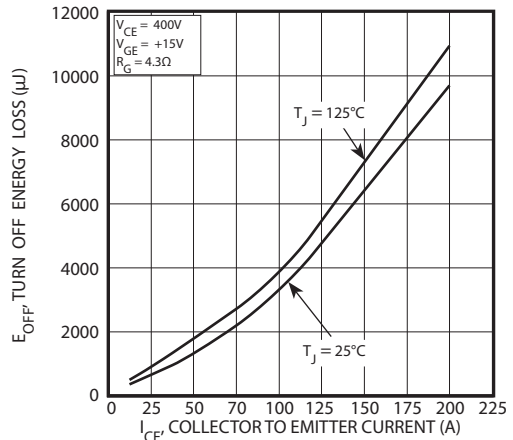

FIGURE 14, Turn Off Energy Loss vs Collector Current

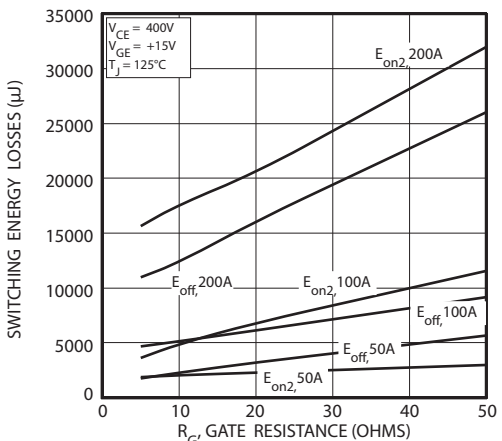

FIGURE 15, Switching Energy Losses vs. Gate Resistance

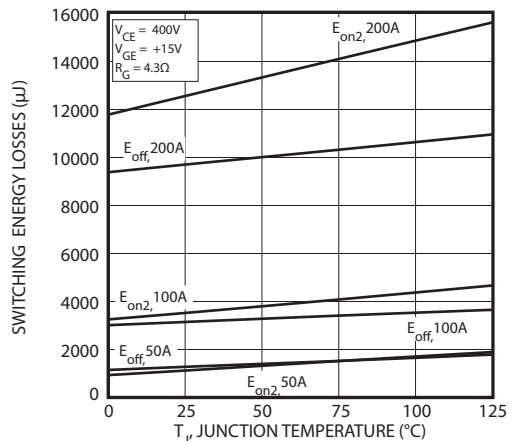

FIGURE 16, Switching Energy Losses vs Junction Temperature

# Typical Performance Curves

APT100GT60B2R\_LR(G)

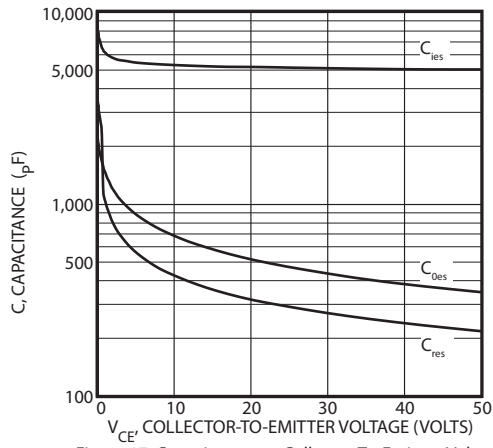

Figure 17, Capacitance vs Collector-To-Emitter Voltage

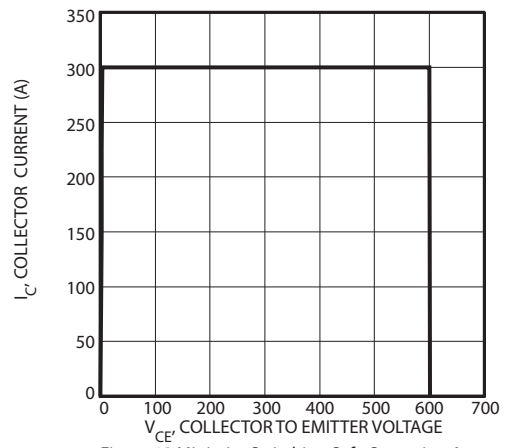

Figure 18, Minimum Switching Safe Operating Area

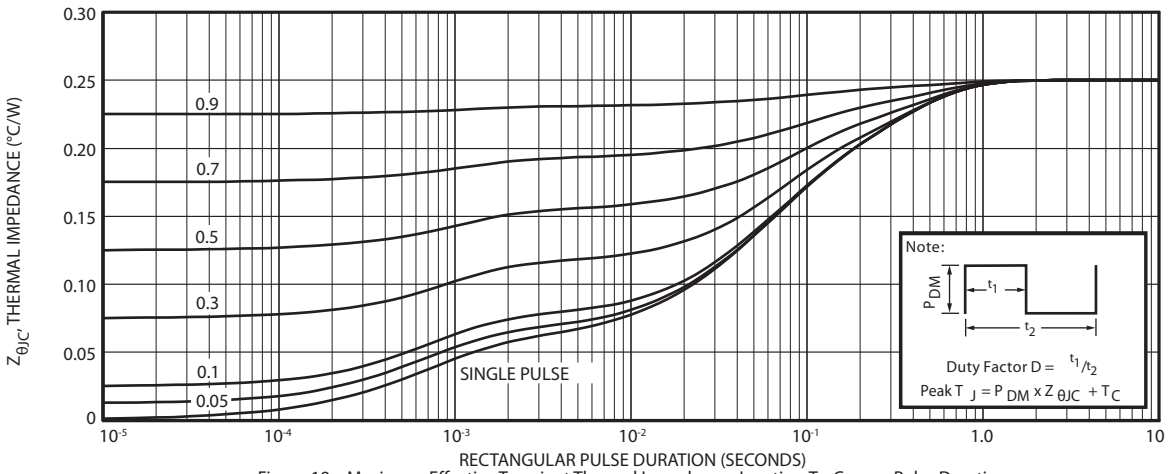

Figure 19a, Maximum Effective Transient Thermal Impedance, Junction-To-Case vs Pulse Duration

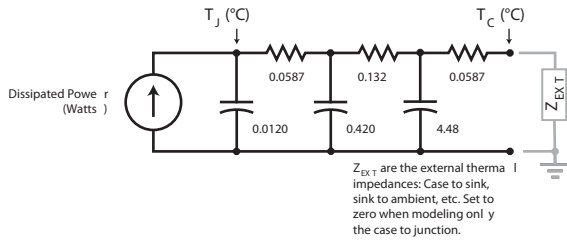

FIGURE 19b, TRANSIENT THERMAL IMPEDANCE MODEL

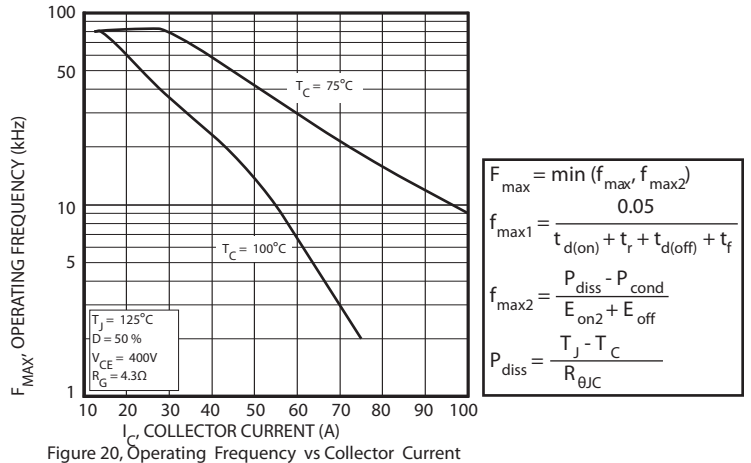

Figure 20, Operating Frequency vs Collector Current

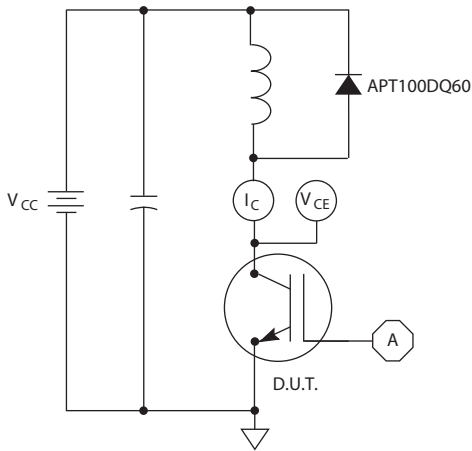

Figure 21, Inductive Switching Test Circuit

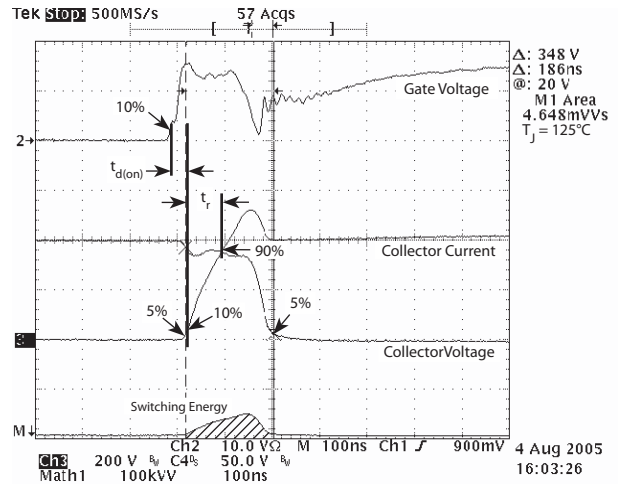

Figure 22, Turn-on Switching Waveforms and Definitions

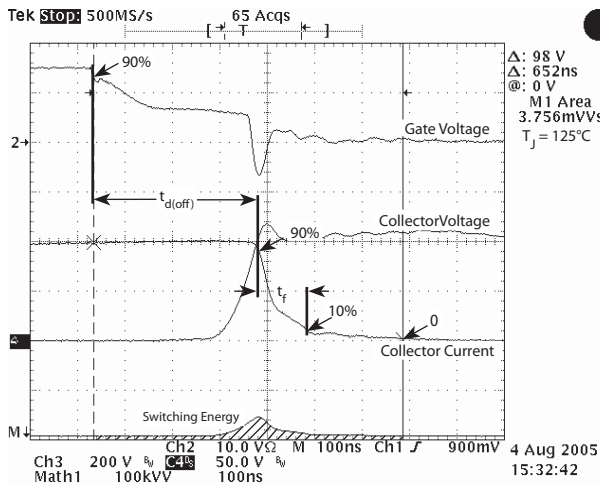
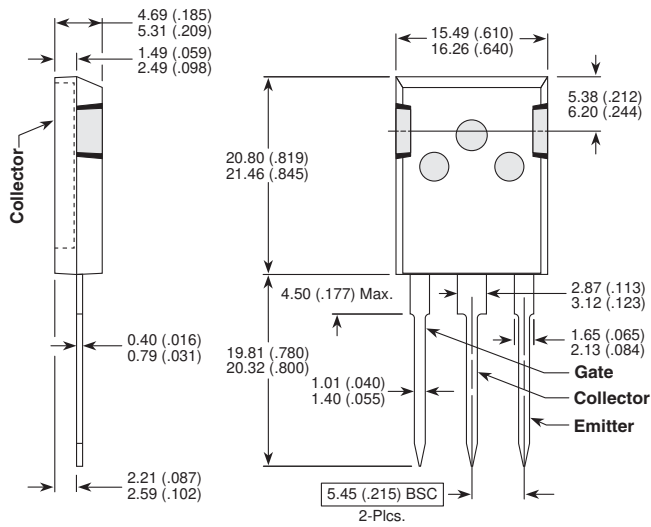

Figure 23, Turn-off Switching Waveforms and Definitions

**T-MAX™ (B2) Package Outline**



These dimensions are equal to the TO-247 without the mounting hole.  
Dimensions in Millimeters and (Inches)

**TO-264 (L) Package Outline**

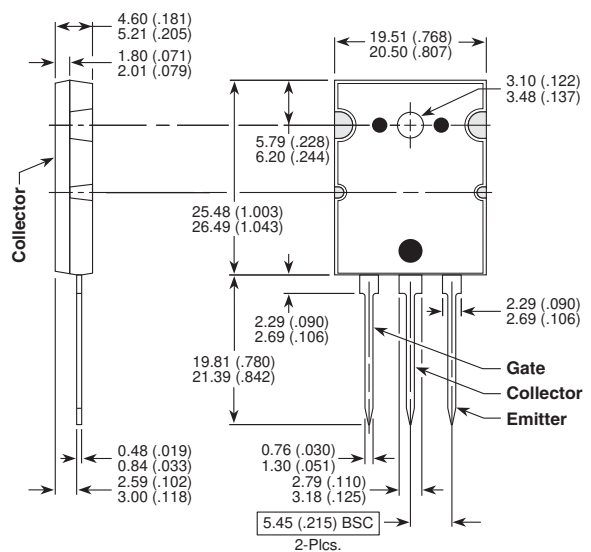

Dimensions in Millimeters and (Inches)