



Chipsmall Limited consists of a professional team with an average of over 10 year of expertise in the distribution of electronic components. Based in Hongkong, we have already established firm and mutual-benefit business relationships with customers from,Europe,America and south Asia,supplying obsolete and hard-to-find components to meet their specific needs.

With the principle of “Quality Parts,Customers Priority,Honest Operation,and Considerate Service”,our business mainly focus on the distribution of electronic components. Line cards we deal with include Microchip,ALPS,ROHM,Xilinx,Pulse,ON,Everlight and Freescale. Main products comprise IC,Modules,Potentiometer,IC Socket,Relay,Connector.Our parts cover such applications as commercial,industrial, and automotives areas.

We are looking forward to setting up business relationship with you and hope to provide you with the best service and solution. Let us make a better world for our industry!



## Contact us

Tel: +86-755-8981 8866 Fax: +86-755-8427 6832

Email & Skype: info@chipsmall.com Web: www.chipsmall.com

Address: A1208, Overseas Decoration Building, #122 Zhenhua RD., Futian, Shenzhen, China



Part Number: APT1608SF4C-PRV

### Features

- 1.6mmX0.8mm SMT LED, 0.75mm thickness.
- Mechanically and spectrally matched to phototransistor.
- Package: 2000pcs / reel .
- Moisture sensitivity level : level 3.
- RoHS compliant.

### Description

SF4 Made with Gallium Aluminum Arsenide Infrared Emitting diodes.

### Package Dimensions

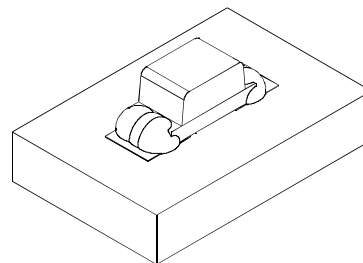
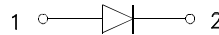
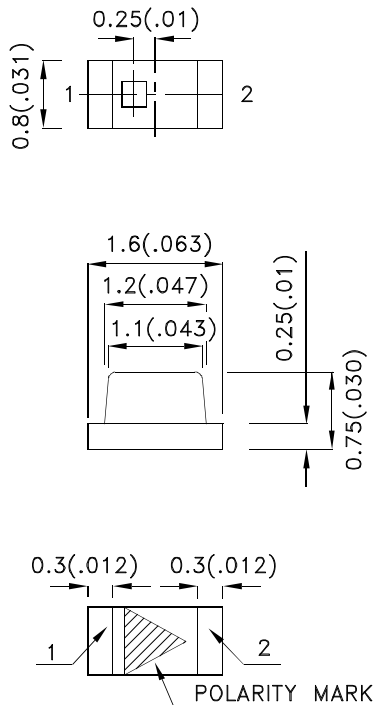

#### Notes:

1. All dimensions are in millimeters (inches).
2. Tolerance is  $\pm 0.1(0.004)$  unless otherwise noted.
3. The specifications, characteristics and technical data described in the datasheet are subject to change without prior notice.
4. The device has a single mounting surface. The device must be mounted according to the specifications.



## Selection Guide

Part No.	Dice	Lens Type	Po (mW/sr) [2] @ 20mA		Viewing Angle [1]
			Min.	Typ.	2θ1/2
APT1608SF4C-PRV	SF4 (GaAlAs)	Water Clear	0.8	1.5	120°

Notes:

1. θ1/2 is the angle from optical centerline where the luminous intensity is 1/2 of the optical peak value.
2. Radiant Intensity/ luminous flux: +/-15%.
3. Radiant intensity value is traceable to the CIE127-2007 compliant national standards.

## Electrical / Optical Characteristics at TA=25°C

Parameter	P/N	Symbol	Typ.	Max.	Units	Test Conditions
Forward Voltage [1]	SF4	V <sub>F</sub>	1.3	1.6	V	I <sub>F</sub> =20mA
Reverse Current	SF4	I <sub>R</sub>		10	μA	V <sub>R</sub> = 5V
Capacitance	SF4	C	90		pF	V <sub>F</sub> =0V;f=1MHz
Peak Spectral Wavelength	SF4	λ <sub>P</sub>	880		nm	I <sub>F</sub> =20mA
Spectral Bandwidth	SF4	Δλ1/2	50		nm	I <sub>F</sub> =20mA

Note:

1. Forward Voltage: +/-0.1V.
2. Wavelength value is traceable to the CIE127-2007 compliant national standards.

## Absolute Maximum Ratings at TA=25°C

Parameter	Symbol	SF4	Units
Power dissipation	P <sub>D</sub>	80	mW
DC Forward Current	I <sub>F</sub>	50	mA
Peak Forward Current [1]	i <sub>FS</sub>	1.2	A
Reverse Voltage	V <sub>R</sub>	5	V
Operating Temperature	T <sub>A</sub>	-40 To +85	°C
Storage Temperature	T <sub>STG</sub>	-40 To +85	°C

Note:

1. 1/100 Duty Cycle, 10μs Pulse Width.

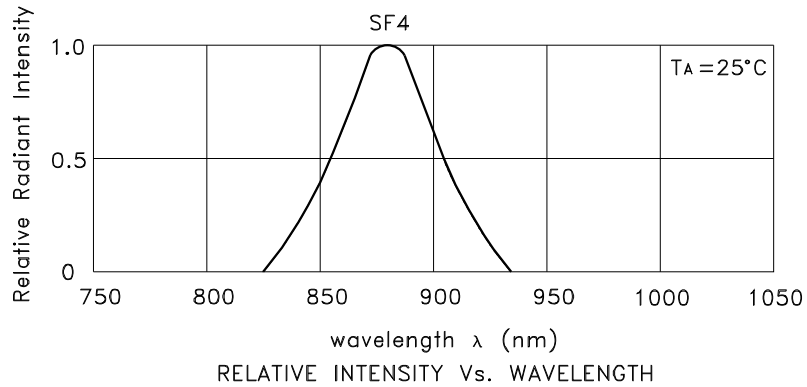

## APT1608SF4C-PRV

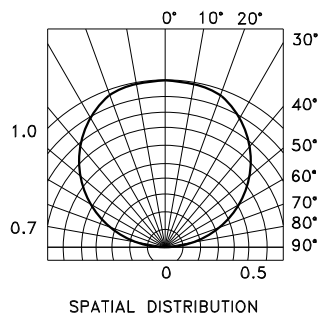
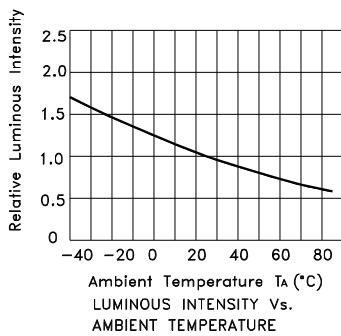
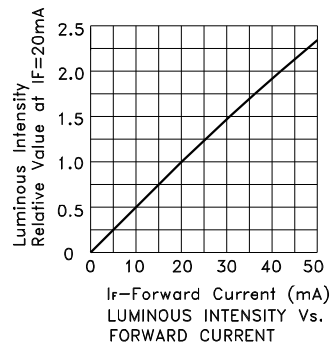
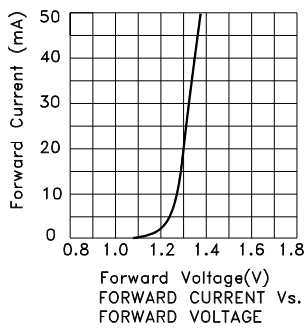

## APT1608SF4C-PRV

Reflow soldering is recommended and the soldering profile is shown below.  
Other soldering methods are not recommended as they might cause damage to the product.

Reflow Soldering Profile For Lead-free SMT Process.

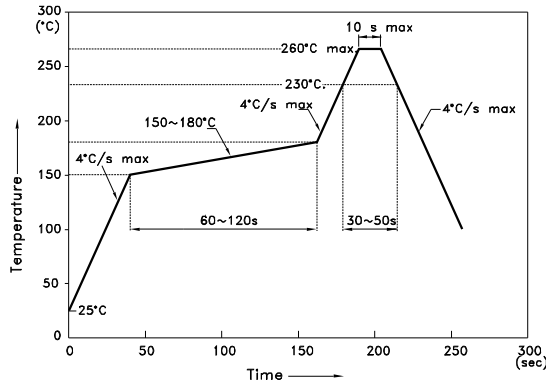

NOTES:

1. We recommend the reflow temperature 245°C(+/-5°C). The maximum soldering temperature should be limited to 260°C.
2. Don't cause stress to the epoxy resin while it is exposed to high temperature.
3. Number of reflow process shall be 2 times or less.

### Recommended Soldering Pattern (Units : mm; Tolerance: ± 0.1)

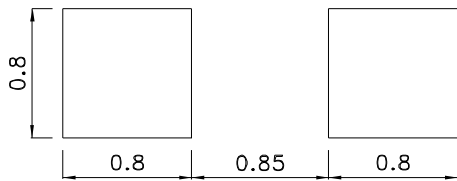

### Reel Dimension

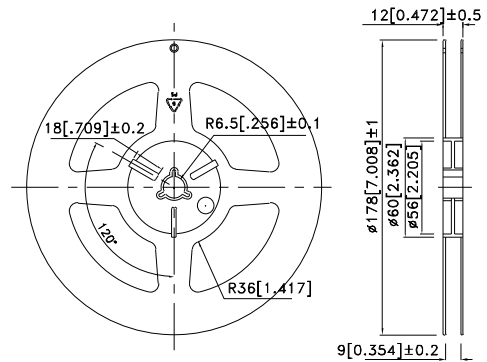

### Tape Specifications (Units : mm)

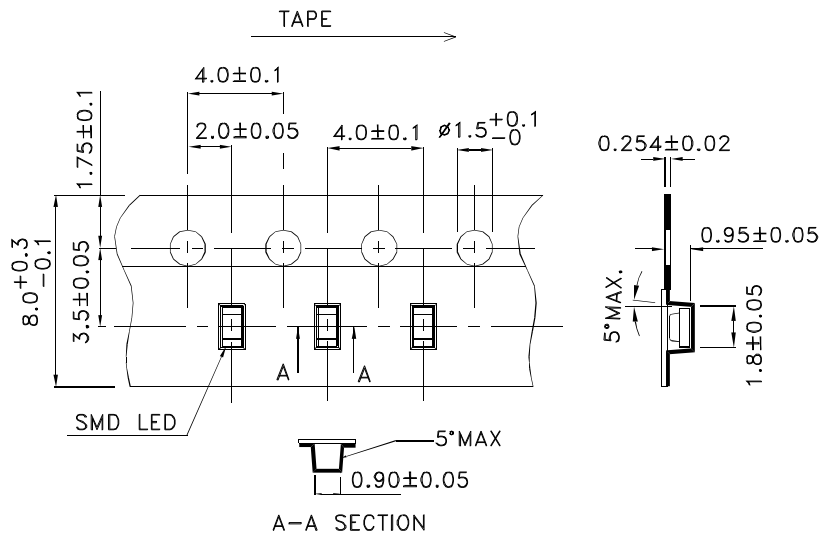

# Kingbright

## PACKING & LABEL SPECIFICATIONS

## APT1608SF4C-PRV

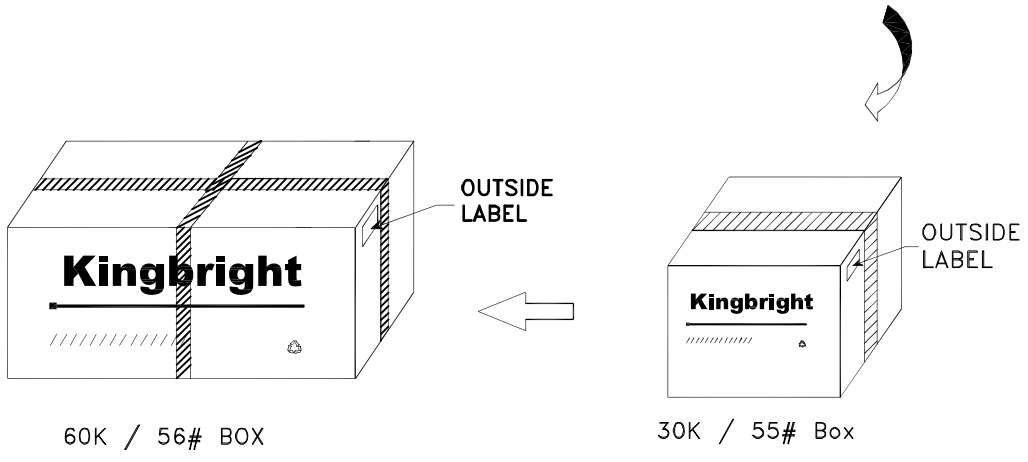
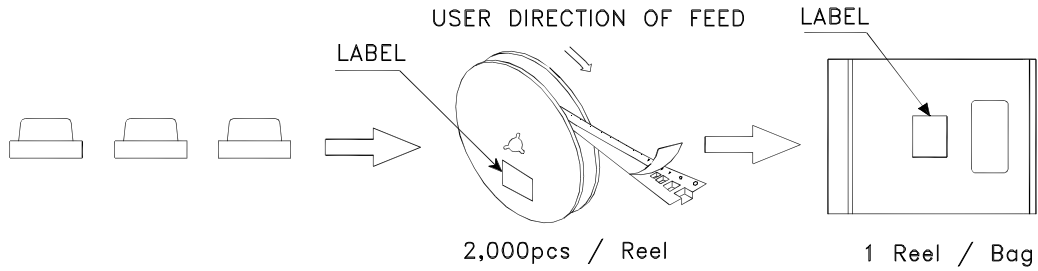

<h1>Kingbright</h1>	
P/NO: APT1608xxx	
QTY: 2,000 pcs	Q.C. <span style="border: 1px solid black; border-radius: 50%; padding: 2px;">Q C XX XX XXXX PASSED</span>
S/N: XXXX	
CODE: XXX	
LOT NO:	
 XXXXXXXXXXXXXXXXXXXXXXXXXXXX	
RoHS Compliant	