



Chipsmall Limited consists of a professional team with an average of over 10 year of expertise in the distribution of electronic components. Based in Hongkong, we have already established firm and mutual-benefit business relationships with customers from,Europe,America and south Asia,supplying obsolete and hard-to-find components to meet their specific needs.

With the principle of “Quality Parts,Customers Priority,Honest Operation,and Considerate Service”,our business mainly focus on the distribution of electronic components. Line cards we deal with include Microchip,ALPS,ROHM,Xilinx,Pulse,ON,Everlight and Freescale. Main products comprise IC,Modules,Potentiometer,IC Socket,Relay,Connector.Our parts cover such applications as commercial,industrial, and automotives areas.

We are looking forward to setting up business relationship with you and hope to provide you with the best service and solution. Let us make a better world for our industry!



Contact us

Tel: +86-755-8981 8866 Fax: +86-755-8427 6832

Email & Skype: info@chipsmall.com Web: www.chipsmall.com

Address: A1208, Overseas Decoration Building, #122 Zhenhua RD., Futian, Shenzhen, China



N-Channel MOSFET

Power MOS 8™ is a high speed, high voltage N-channel switch-mode power MOSFET. A proprietary planar stripe design yields excellent reliability and manufacturability. Low switching loss is achieved with low input capacitance and ultra low C_{rss} "Miller" capacitance. The intrinsic gate resistance and capacitance of the poly-silicon gate structure help control slew rates during switching, resulting in low EMI and reliable paralleling, even when switching at very high frequency. Reliability in flyback, boost, forward, and other circuits is enhanced by the high avalanche energy capability.

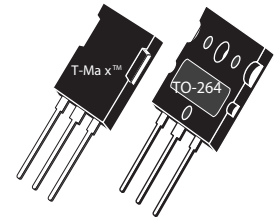

APT28M120B2

APT28M120L

Single die MOSFET

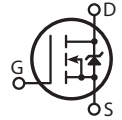

FEATURES

- Fast switching with low EMI/RFI
- Low $R_{DS(on)}$
- Ultra low C_{rss} for improved noise immunity
- Low gate charge
- Avalanche energy rated
- RoHS compliant 

TYPICAL APPLICATIONS

- PFC and other boost converter
- Buck converter
- Two switch forward (asymmetrical bridge)
- Single switch forward
- Flyback
- Inverters

Absolute Maximum Ratings

Symbol	Parameter	Ratings	Unit
I_D	Continuous Drain Current @ $T_C = 25^\circ\text{C}$	29	A
	Continuous Drain Current @ $T_C = 100^\circ\text{C}$	18	
I_{DM}	Pulsed Drain Current ^①	104	
V_{GS}	Gate-Source Voltage	±30	V
E_{AS}	Single Pulse Avalanche Energy ^②	2165	mJ
I_{AR}	Avalanche Current, Repetitive or Non-Repetitive	14	A

Thermal and Mechanical Characteristics

Symbol	Characteristic	Min	Typ	Max	Unit
P_D	Total Power Dissipation @ $T_C = 25^\circ\text{C}$			1135	W
$R_{\theta JC}$	Junction to Case Thermal Resistance			0.11	°C/W
$R_{\theta CS}$	Case to Sink Thermal Resistance, Flat, Greased Surface		0.11		
T_J, T_{STG}	Operating and Storage Junction Temperature Range	-55		150	°C
T_L	Soldering Temperature for 10 Seconds (1.6mm from case)			300	
W_T	Package Weight		0.22		oz
			6.2		g
Torque	Mounting Torque (TO-264 Package), 4-40 or M3 screw			10	in·lbf
				1.1	N·m

Static Characteristics
T_J = 25°C unless otherwise specified
APT28M120B2_L

Symbol	Parameter	Test Conditions	Min	Typ	Max	Unit
V _{BR(DSS)}	Drain-Source Breakdown Voltage	V _{GS} = 0V, I _D = 250μA	1200			V
ΔV _{BR(DSS)} /ΔT _J	Breakdown Voltage Temperature Coefficient	Reference to 25°C, I _D = 250μA		1.41		V/°C
R _{DS(on)}	Drain-Source On Resistance ^③	V _{GS} = 10V, I _D = 14A		0.45	0.53	Ω
V _{GS(th)}	Gate-Source Threshold Voltage	V _{GS} = V _{DS} , I _D = 2.5mA	3	4	5	V
ΔV _{GS(th)} /ΔT _J	Threshold Voltage Temperature Coefficient			-10		mV/°C
I _{DSS}	Zero Gate Voltage Drain Current	V _{DS} = 1200V V _{GS} = 0V			100	μA
		T _J = 25°C T _J = 125°C			500	
I _{GSS}	Gate-Source Leakage Current	V _{GS} = ±30V			±100	nA

Dynamic Characteristics
T_J = 25°C unless otherwise specified

Symbol	Parameter	Test Conditions	Min	Typ	Max	Unit
g _{fs}	Forward Transconductance	V _{DS} = 50V, I _D = 14A		31		S
C _{iss}	Input Capacitance	V _{GS} = 0V, V _{DS} = 25V f = 1MHz		9670		pF
C _{rss}	Reverse Transfer Capacitance			115		
C _{oss}	Output Capacitance			715		
C _{o(cr)} ^④	Effective Output Capacitance, Charge Related	V _{GS} = 0V, V _{DS} = 0V to 800V		275		
C _{o(er)} ^⑤	Effective Output Capacitance, Energy Related			140		
Q _g	Total Gate Charge	V _{GS} = 0 to 10V, I _D = 14A, V _{DS} = 600V		300		nC
Q _{gs}	Gate-Source Charge			50		
Q _{gd}	Gate-Drain Charge			140		
t _{d(on)}	Turn-On Delay Time	Resistive Switching V _{DD} = 800V, I _D = 14A R _G = 2.2Ω ^⑥ , V _{GG} = 15V		50		ns
t _r	Current Rise Time			31		
t _{d(off)}	Turn-Off Delay Time			170		
t _f	Current Fall Time			48		

Source-Drain Diode Characteristics

Symbol	Parameter	Test Conditions	Min	Typ	Max	Unit
I _S	Continuous Source Current (Body Diode)	MOSFET symbol showing the integral reverse p-n junction diode (body diode)			29	A
I _{SM}	Pulsed Source Current (Body Diode) ^①				104	
V _{SD}	Diode Forward Voltage	I _{SD} = 14A, T _J = 25°C, V _{GS} = 0V			1	V
t _{rr}	Reverse Recovery Time	I _{SD} = 14A ^②		1290		ns
Q _{rr}	Reverse Recovery Charge	di _{SD} /dt = 100A/μs, T _J = 25°C		33		μC
dv/dt	Peak Recovery dv/dt	I _{SD} ≤ 14A, di/dt ≤ 1000A/μs, V _{DD} = 100V, T _J = 125°C			10	V/ns

① Repetitive Rating: Pulse width and case temperature limited by maximum junction temperature.

② Starting at T_J = 25°C, L = 22.09mH, R_G = 2.2Ω, I_{AS} = 14A.

③ Pulse test: Pulse Width < 380μs, duty cycle < 2%.

④ C_{o(cr)} is defined as a fixed capacitance with the same stored charge as C_{OSS} with V_{DS} = 67% of V_{(BR)DSS}.

⑤ C_{o(er)} is defined as a fixed capacitance with the same stored energy as C_{OSS} with V_{DS} = 67% of V_{(BR)DSS}. To calculate C_{o(er)} for any value of V_{DS} less than V_{(BR)DSS}, use this equation: C_{o(er)} = -4.40E-7/V_{DS}² + 5.34E-8/V_{DS} + 7.59E-11.

⑥ R_G is external gate resistance, not including internal gate resistance or gate driver impedance. (MIC4452)

Microsemi reserves the right to change, without notice, the specifications and information contained herein.

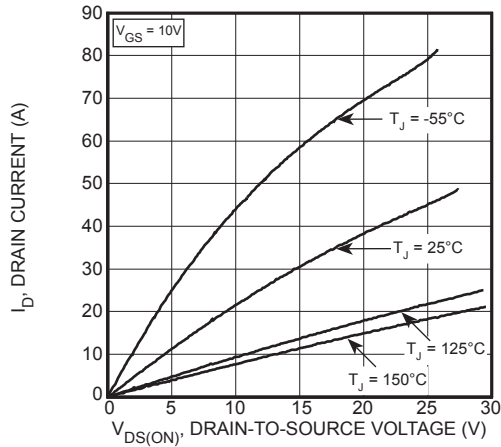

Figure 1, Output Characteristics

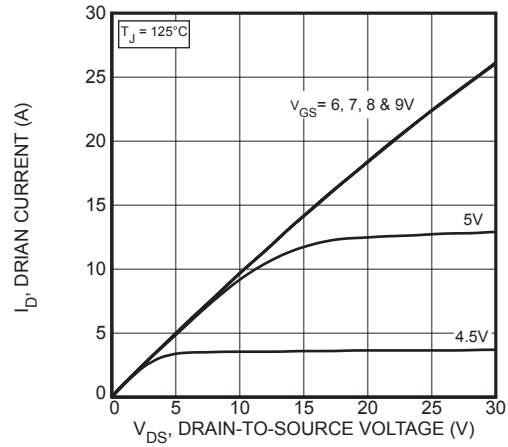

Figure 2, Output Characteristics

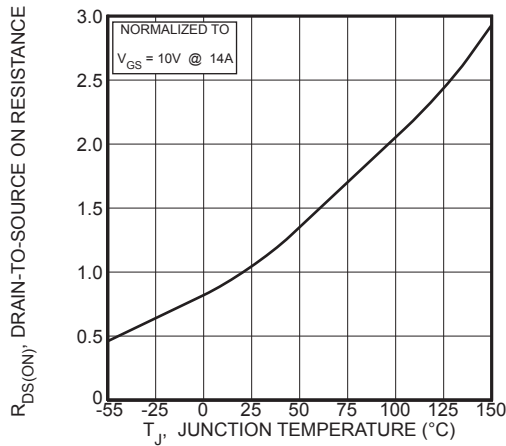

Figure 3, $R_{DS(ON)}$ vs Junction Temperature

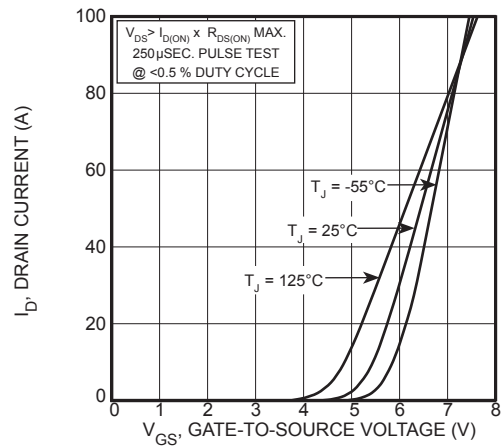

Figure 4, Transfer Characteristics

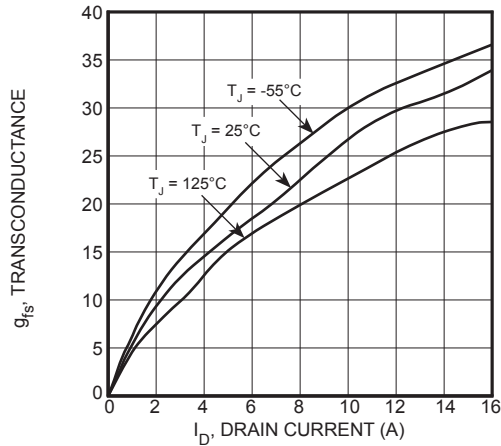

Figure 5, Gain vs Drain Current

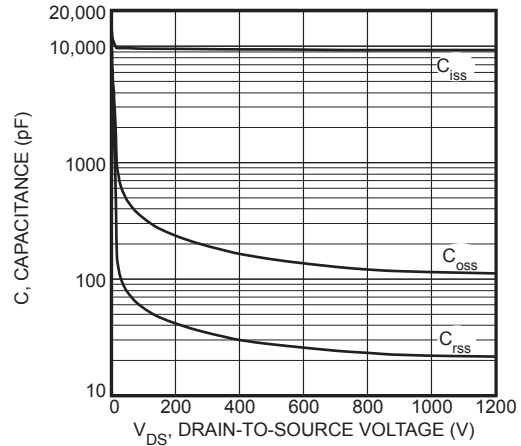

Figure 6, Capacitance vs Drain-to-Source Voltage

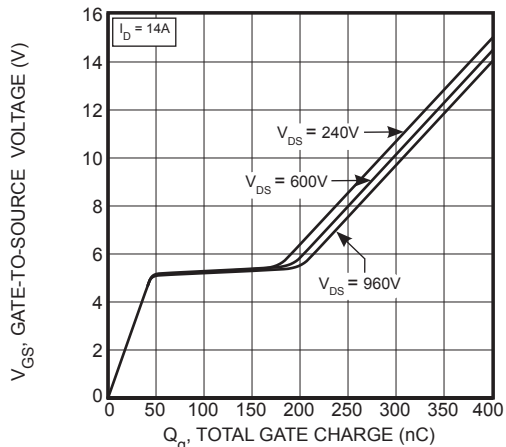

Figure 7, Gate Charge vs Gate-to-Source Voltage

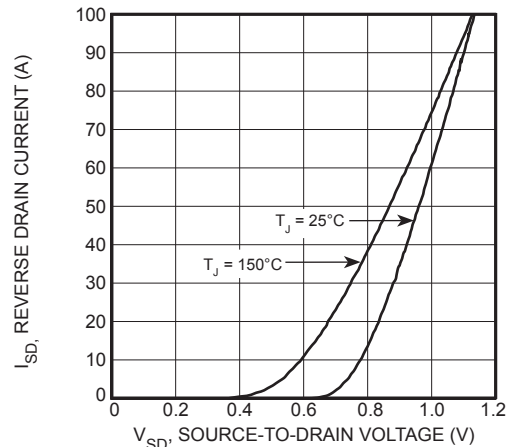
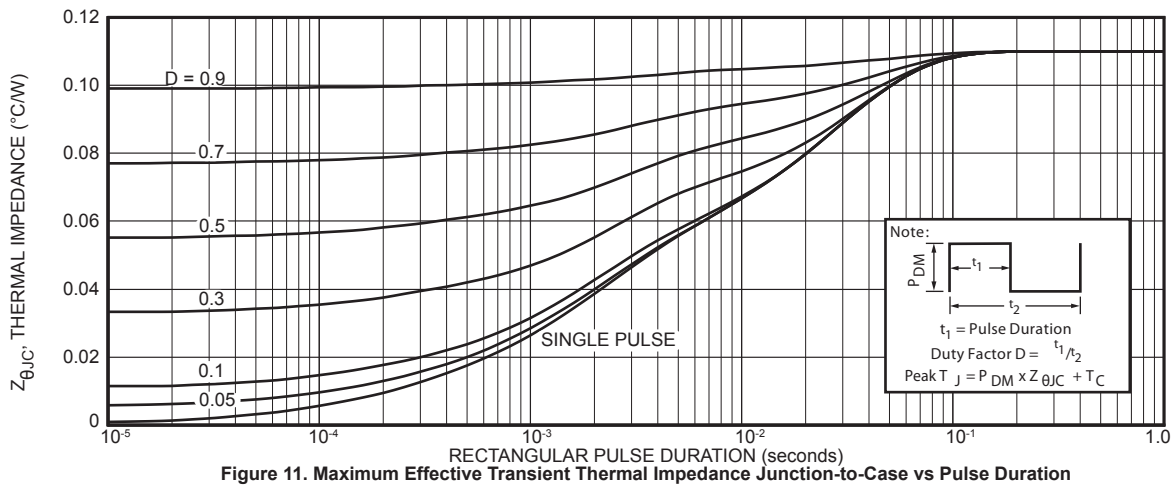
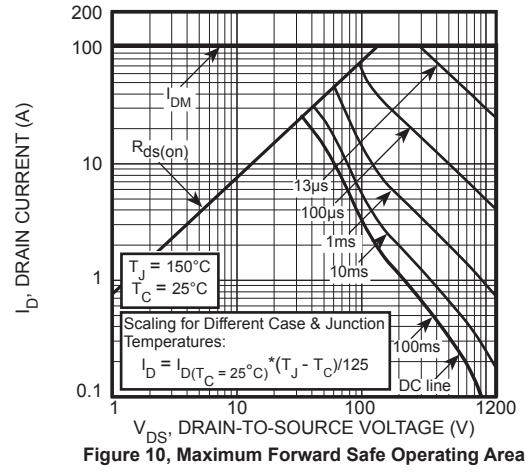
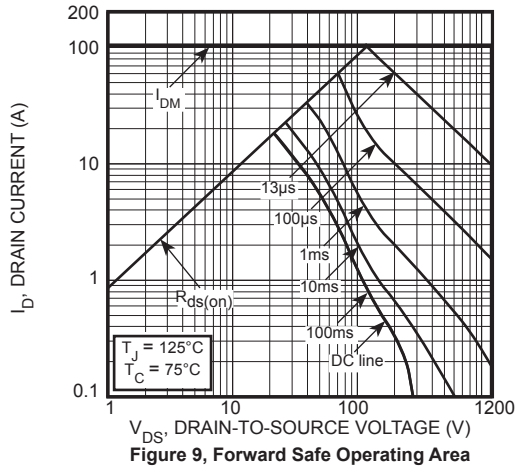

Figure 8, Reverse Drain Current vs Source-to-Drain Voltage



T-MAX® (B2) Package Outline

TO-264 (L) Package Outline

Ⓜ 100% Sn Plated

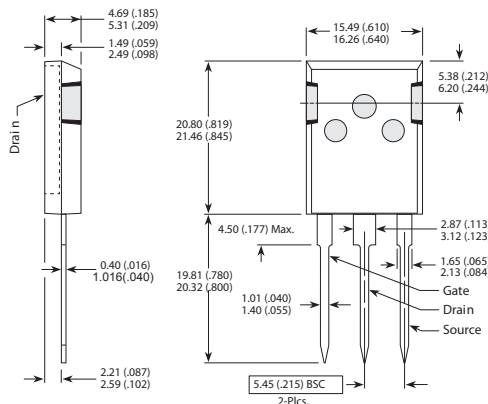

These dimensions are equal to the TO-247 without the mounting hole.

Dimensions in Millimeters (Inches)

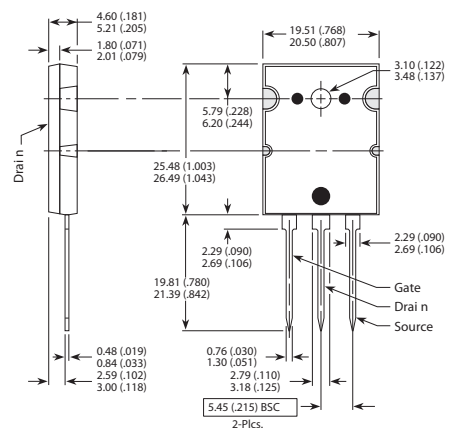

Dimensions in Millimeters (Inches)