



Chipsmall Limited consists of a professional team with an average of over 10 year of expertise in the distribution of electronic components. Based in Hongkong, we have already established firm and mutual-benefit business relationships with customers from,Europe,America and south Asia,supplying obsolete and hard-to-find components to meet their specific needs.

With the principle of “Quality Parts,Customers Priority,Honest Operation,and Considerate Service”,our business mainly focus on the distribution of electronic components. Line cards we deal with include Microchip,ALPS,ROHM,Xilinx,Pulse,ON,Everlight and Freescale. Main products comprise IC,Modules,Potentiometer,IC Socket,Relay,Connector.Our parts cover such applications as commercial,industrial, and automotives areas.

We are looking forward to setting up business relationship with you and hope to provide you with the best service and solution. Let us make a better world for our industry!



Contact us

Tel: +86-755-8981 8866 Fax: +86-755-8427 6832

Email & Skype: info@chipsmall.com Web: www.chipsmall.com

Address: A1208, Overseas Decoration Building, #122 Zhenhua RD., Futian, Shenzhen, China



Utilizing the latest Non-Punch Through (NPT) Field Stop technology, these IGBT's have a very short, low amplitude tail current and low Eoff. The Trench Gate design results in superior $V_{CE(on)}$ performance. Easy paralleling results from very tight parameter distribution and slightly positive $V_{CE(on)}$ temperature coefficient. Built-in gate resistance ensures ultra-reliable operation. Low gate charge simplifies gate drive design and minimizes losses.

- **1200V NPT Field Stop**
- **Trench Gate: Low $V_{CE(on)}$**
- **Easy Paralleling**
- **10 μ s Short Circuit Capability**
- **Intergrated Gate Resistor: Low EMI, High Reliability**

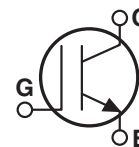
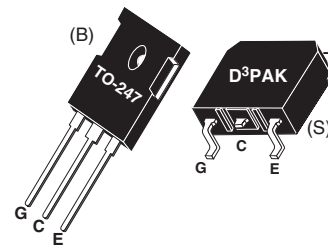

Applications: Welding, Inductive Heating, Solar Inverters, SMPS, Motor drives, UPS

MAXIMUM RATINGS

All Ratings: $T_C = 25^\circ\text{C}$ unless otherwise specified.

Symbol	Parameter	APT35GN120B_S(G)	UNIT
V_{CES}	Collector-Emitter Voltage	1200	Volts
V_{GE}	Gate-Emitter Voltage	± 30	
I_{C1}	Continuous Collector Current @ $T_C = 25^\circ\text{C}$	94	Amps
I_{C2}	Continuous Collector Current @ $T_C = 110^\circ\text{C}$	46	
I_{CM}	Pulsed Collector Current ^① @ $T_C = 150^\circ\text{C}$	105	
SSOA	Switching Safe Operating Area @ $T_J = 150^\circ\text{C}$	105A @ 1200V	
P_D	Total Power Dissipation	379	Watts
T_J, T_{STG}	Operating and Storage Junction Temperature Range	-55 to 150	$^\circ\text{C}$
T_L	Max. Lead Temp. for Soldering: 0.063" from Case for 10 Sec.	300	

STATIC ELECTRICAL CHARACTERISTICS

Symbol	Characteristic / Test Conditions	MIN	TYP	MAX	Units
$V_{(BR)CES}$	Collector-Emitter Breakdown Voltage ($V_{GE} = 0V, I_C = 250\mu\text{A}$)	1200			Volts
$V_{GE(TH)}$	Gate Threshold Voltage ($V_{CE} = V_{GE}, I_C = 1\text{mA}, T_J = 25^\circ\text{C}$)	5	5.8	6.5	
$V_{CE(ON)}$	Collector-Emitter On Voltage ($V_{GE} = 15V, I_C = 35A, T_J = 25^\circ\text{C}$)	1.4	1.7	2.1	
	Collector-Emitter On Voltage ($V_{GE} = 15V, I_C = 35A, T_J = 125^\circ\text{C}$)		1.9		
I_{CES}	Collector Cut-off Current ($V_{CE} = 1200V, V_{GE} = 0V, T_J = 25^\circ\text{C}$) ^②			100	μA
	Collector Cut-off Current ($V_{CE} = 1200V, V_{GE} = 0V, T_J = 125^\circ\text{C}$) ^②			TBD	
I_{GES}	Gate-Emitter Leakage Current ($V_{GE} = \pm 20V$)			600	nA
R_{GINT}	Intergrated Gate Resistor		6		Ω

 **CAUTION:** These Devices are Sensitive to Electrostatic Discharge. Proper Handling Procedures Should Be Followed.

DYNAMIC CHARACTERISTICS

APT35GN120B_S(G)

Symbol	Characteristic	Test Conditions	MIN	TYP	MAX	UNIT	
C_{ies}	Input Capacitance	Capacitance $V_{GE} = 0V, V_{CE} = 25V$ $f = 1\text{ MHz}$		2500		pF	
C_{oes}	Output Capacitance			150			
C_{res}	Reverse Transfer Capacitance			120			
V_{GEP}	Gate-to-Emitter Plateau Voltage	Gate Charge $V_{GE} = 15V$ $V_{CE} = 600V$ $I_C = 35A$		9.5		V	
Q_g	Total Gate Charge ^③			220			
Q_{ge}	Gate-Emitter Charge			15			
Q_{gc}	Gate-Collector ("Miller") Charge			130			
SSOA	Switching Safe Operating Area	$T_J = 150^\circ\text{C}, R_G = 2.2\Omega^{⑦}, V_{GE} = 15V, L = 100\mu\text{H}, V_{CE} = 1200V$	105			A	
SCSOA	Short Circuit Safe Operating Area	$V_{CC} = 960V, V_{GE} = 15V, T_J = 125^\circ\text{C}, R_G = 2.2\Omega^{⑦}$	10			μs	
$t_{d(on)}$	Turn-on Delay Time	Inductive Switching (25°C) $V_{CC} = 800V$ $V_{GE} = 15V$ $I_C = 35A$ $R_G = 2.2\Omega^{⑦}$ $T_J = +25^\circ\text{C}$		24		ns	
t_r	Current Rise Time			22			
$t_{d(off)}$	Turn-off Delay Time			300			
t_f	Current Fall Time			55			
E_{on1}	Turn-on Switching Energy ^④				TBD		μJ
E_{on2}	Turn-on Switching Energy (Diode) ^⑤			2395			
E_{off}	Turn-off Switching Energy ^⑥			2315			
$t_{d(on)}$	Turn-on Delay Time		Inductive Switching (125°C) $V_{CC} = 800V$ $V_{GE} = 15V$ $I_C = 35A$ $R_G = 2.2\Omega^{⑦}$ $T_J = +125^\circ\text{C}$		24		ns
t_r	Current Rise Time				22		
$t_{d(off)}$	Turn-off Delay Time				365		
t_f	Current Fall Time			100			
E_{on1}	Turn-on Switching Energy ^④				TBD		μJ
E_{on2}	Turn-on Switching Energy (Diode) ^⑤			3745			
E_{off}	Turn-off Switching Energy ^⑥			3435			

THERMAL AND MECHANICAL CHARACTERISTICS

Symbol	Characteristic	MIN	TYP	MAX	UNIT
$R_{\theta JC}$	Junction to Case (IGBT)			.33	$^\circ\text{C/W}$
$R_{\theta JC}$	Junction to Case (DIODE)			N/A	
W_T	Package Weight		5.9		gm

① Repetitive Rating: Pulse width limited by maximum junction temperature.

② For Combi devices, I_{ces} includes both IGBT and FRED leakages

③ See MIL-STD-750 Method 3471.

④ E_{on1} is the clamped inductive turn-on-energy of the IGBT only, without the effect of a commutating diode reverse recovery current adding to the IGBT turn-on loss. (See Figure 24.)

⑤ E_{on2} is the clamped inductive turn-on energy that includes a commutating diode reverse recovery current in the IGBT turn-on switching loss. (See Figures 21, 22.)

⑥ E_{off} is the clamped inductive turn-off energy measured in accordance with JEDEC standard JESD24-1. (See Figures 21, 23.)

⑦ R_G is external gate resistance, not including R_{Gint} nor gate driver impedance. (MIC4452)

Microsemi Reserves the right to change, without notice, the specifications and information contained herein.

TYPICAL PERFORMANCE CURVES

APT35GN120B_S(G)

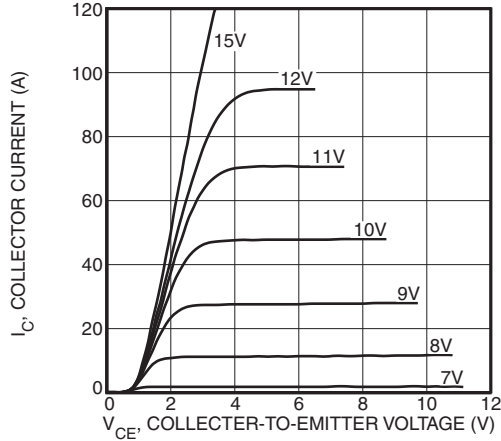

FIGURE 1, Output Characteristics ($T_J = 25^\circ\text{C}$)

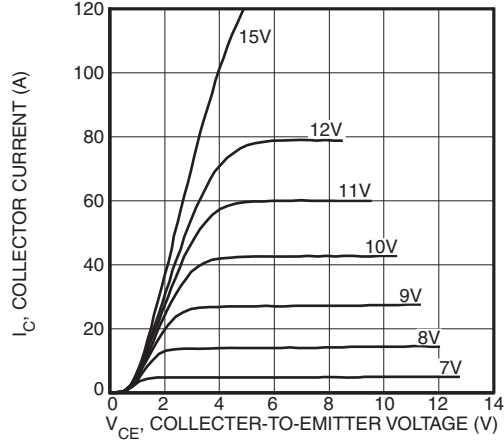

FIGURE 2, Output Characteristics ($T_J = 125^\circ\text{C}$)

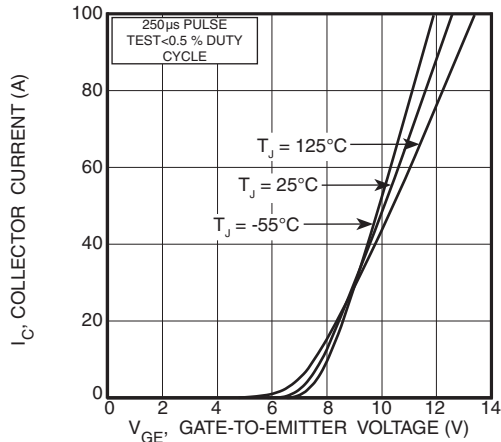

FIGURE 3, Transfer Characteristics

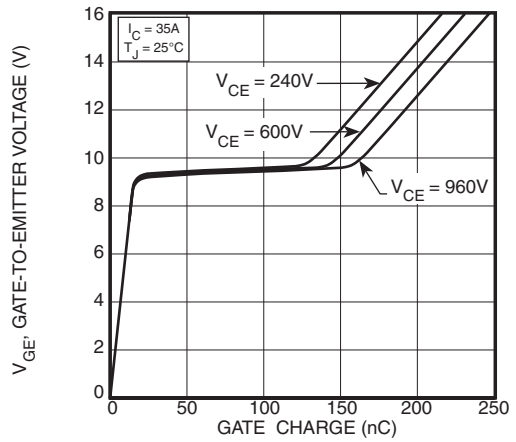

FIGURE 4, Gate Charge

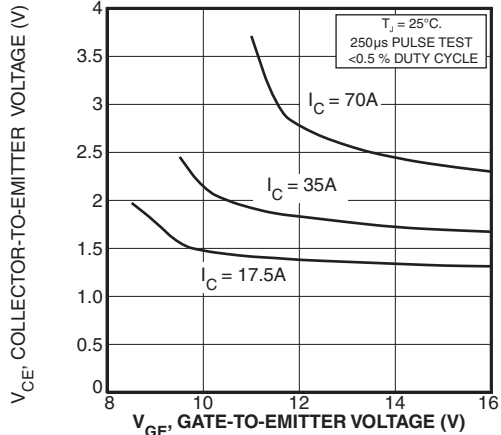

FIGURE 5, On State Voltage vs Gate-to-Emitter Voltage

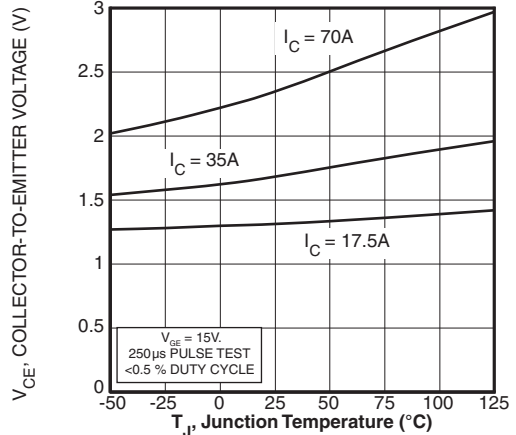

FIGURE 6, On State Voltage vs Junction Temperature

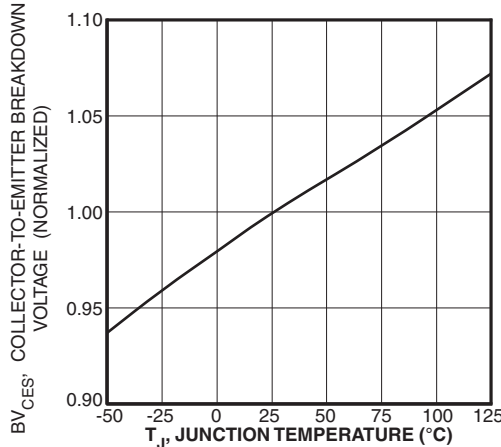

FIGURE 7, Breakdown Voltage vs. Junction Temperature

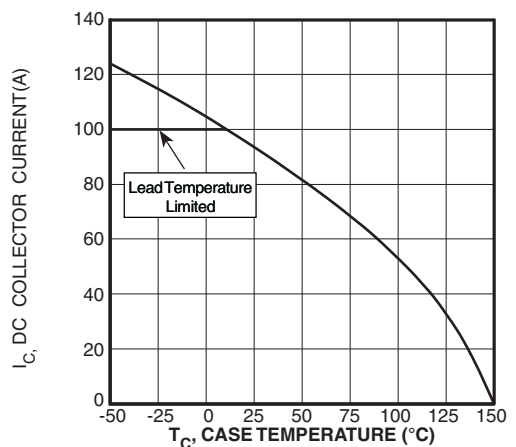

FIGURE 8, DC Collector Current vs Case Temperature

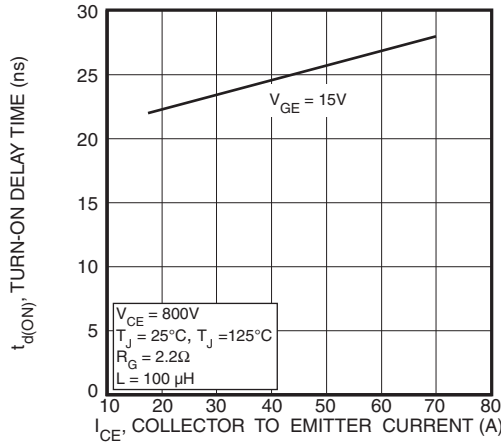

FIGURE 9, Turn-On Delay Time vs Collector Current

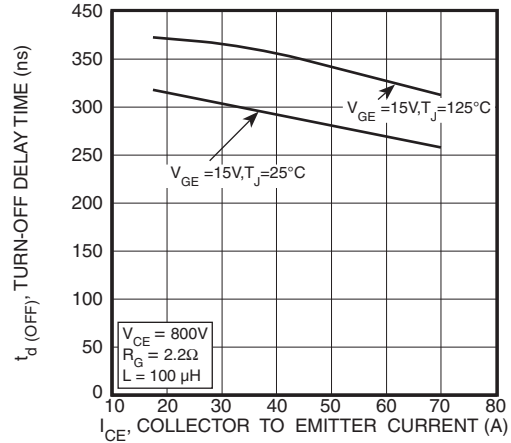

FIGURE 10, Turn-Off Delay Time vs Collector Current

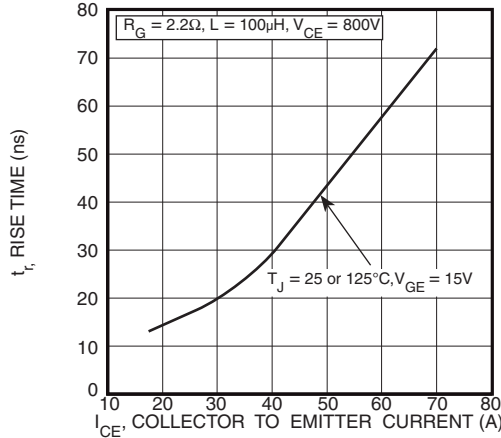

FIGURE 11, Current Rise Time vs Collector Current

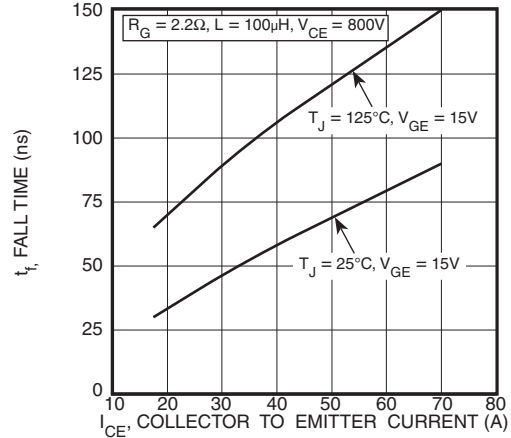

FIGURE 12, Current Fall Time vs Collector Current

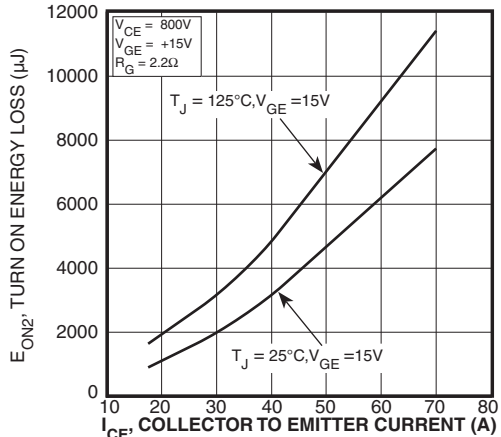

FIGURE 13, Turn-On Energy Loss vs Collector Current

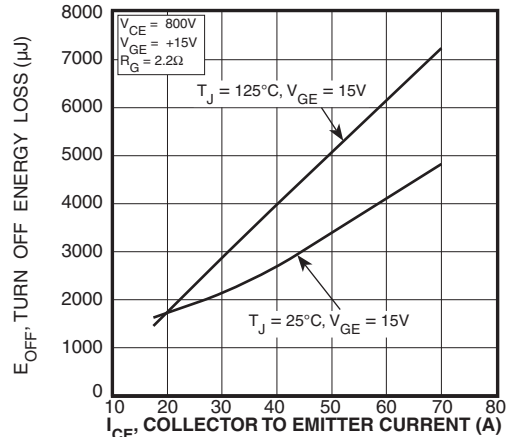

FIGURE 14, Turn Off Energy Loss vs Collector Current

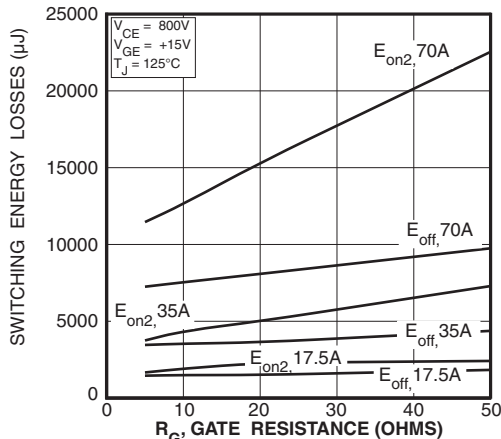

FIGURE 15, Switching Energy Losses vs. Gate Resistance

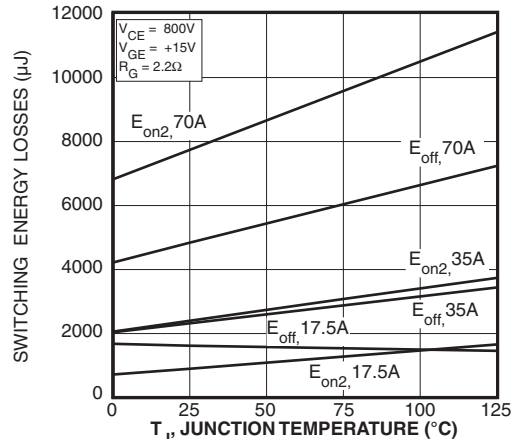

FIGURE 16, Switching Energy Losses vs Junction Temperature

TYPICAL PERFORMANCE CURVES

APT35GN120B_S(G)

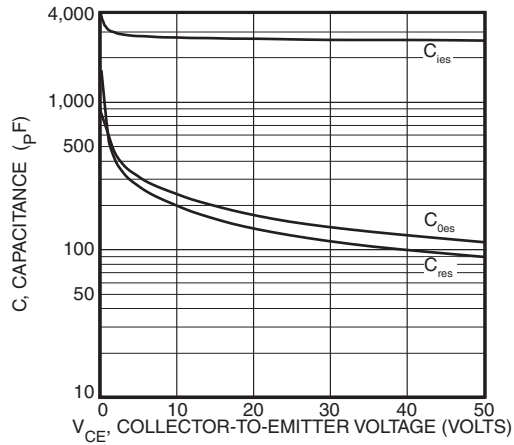

Figure 17, Capacitance vs Collector-To-Emitter Voltage

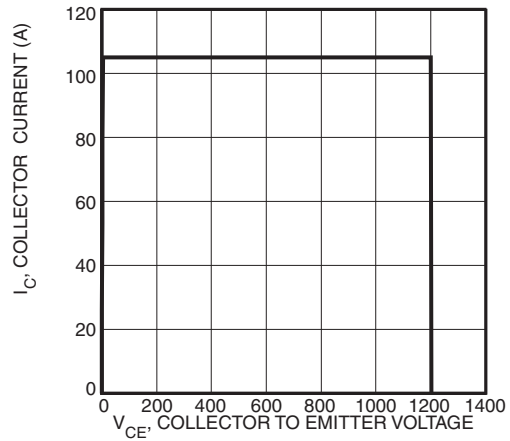

Figure 18, Minimum Switching Safe Operating Area

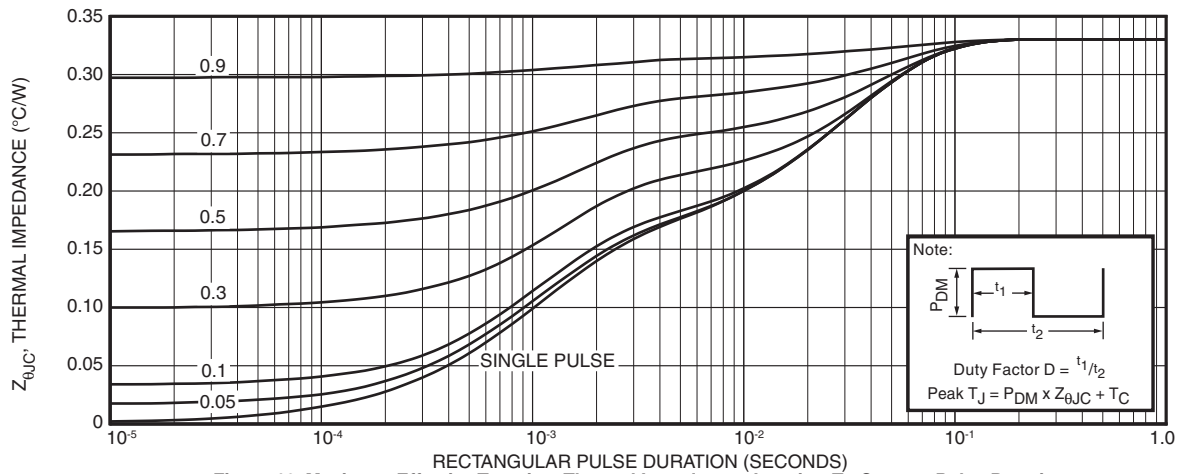

Figure 19, Maximum Effective Transient Thermal Impedance, Junction-To-Case vs Pulse Duration

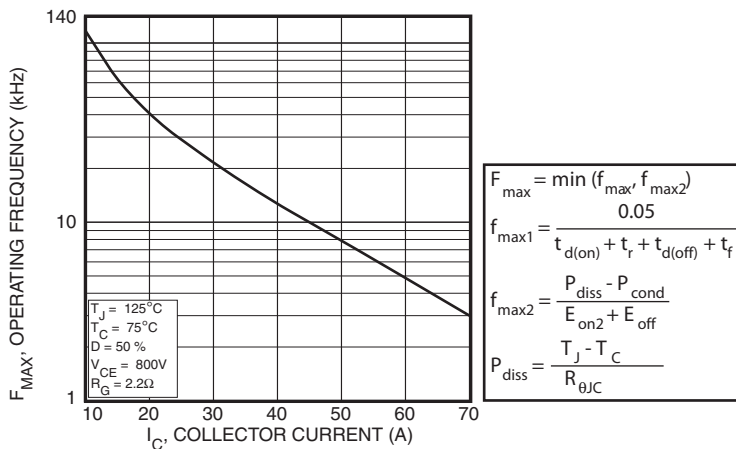

Figure 20, Operating Frequency vs Collector Current

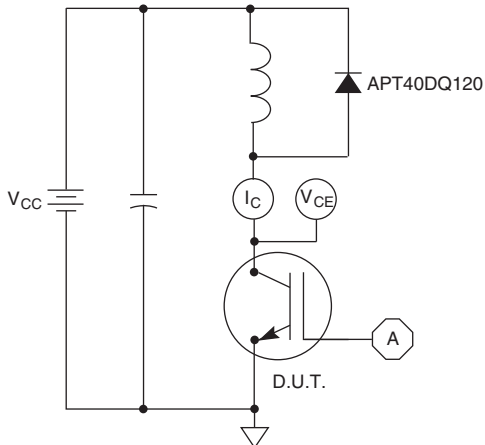

Figure 21, Inductive Switching Test Circuit

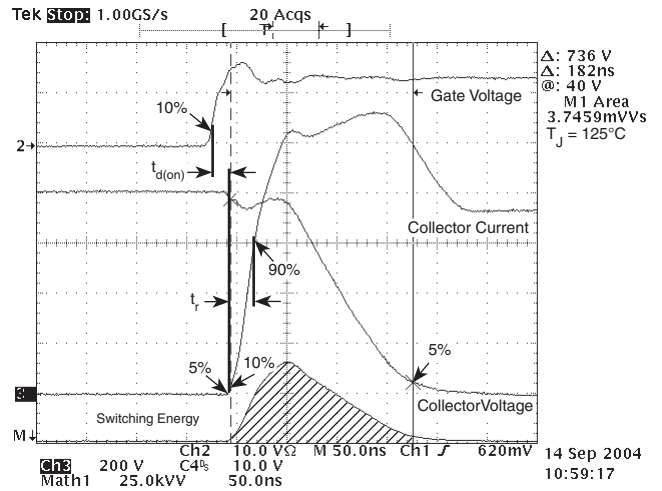

Figure 22, Turn-on Switching Waveforms and Definitions

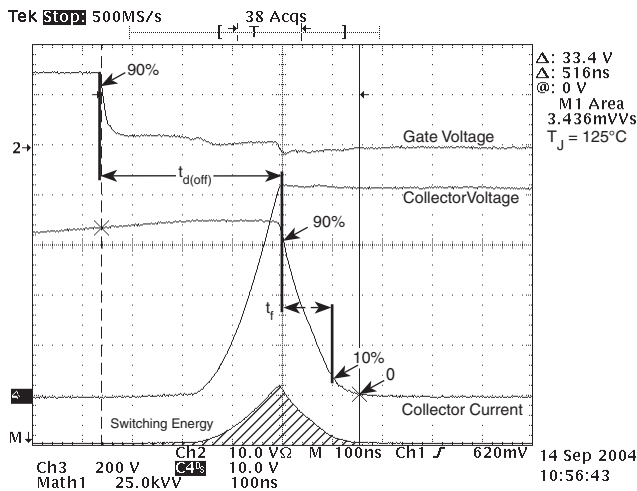

Figure 23, Turn-off Switching Waveforms and Definitions

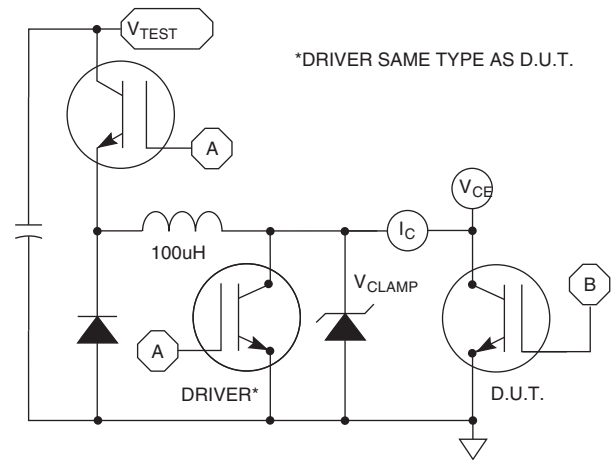
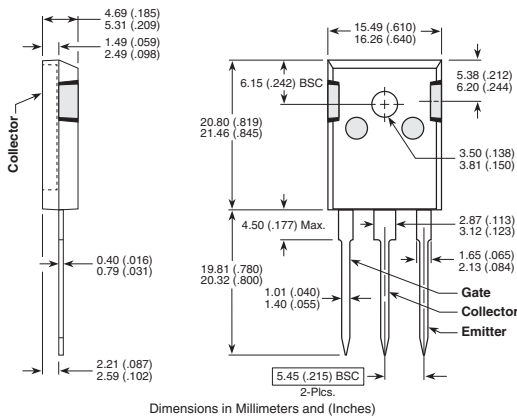

Figure 24, EON1 Test Circuit

TO-247 Package Outline

e1 SAC: Tin, Silver, Copper



Dimensions in Millimeters and (Inches)

D³PAK Package Outline

e3 SAC: Tin, Silver, Copper

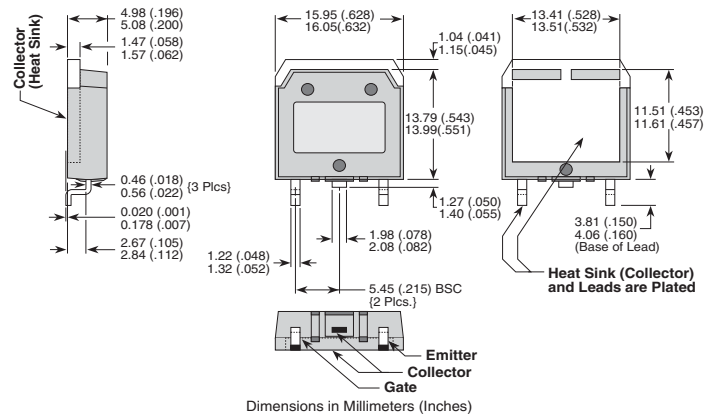

Dimensions in Millimeters (Inches)